

Allianz Global Investors Fund

Société d'Investissement à Capital Variable

Prospectus 29 September 2023

Allianz Global Investors GmbH

Important Information for Investors

The Directors accept responsibility for the information contained in this Prospectus. To the best of the knowledge and belief of the Directors (who have taken all reasonable care to ensure that such is the case) the information contained in this Prospectus is in accordance with the facts and does not omit anything likely to affect the import of such information. The Directors accept responsibility accordingly.

If you have any doubts about the content of this Prospectus, you should consult with your broker, the customer service representative at your bank, your lawyer, tax advisor, auditor or another financial advisor. Any Appendix, and any subsequent supplements to this Prospectus, form part of this Prospectus and should be read accordingly.

The Company is registered under Part I of the Law. This registration does not require the CSSF to approve or disapprove of either the adequacy or accuracy of the information contained in this Prospectus, or the assets or portfolios held by the Sub-Funds. Any representation to the contrary is unauthorised.

The value of Shares and income arising from them may rise and fall and investors may not recover the amount originally invested. Before investing in a Sub-Fund, investors are advised to take into account the risks associated with making an investment (see "Risk Factors" under Section XV). Investors should inform themselves as to any applicable legal requirements, any foreign-exchange restrictions, or any tax implication in their country of citizenship, residence or domicile prior to the purchase, conversion or redemption of Shares.

The annual and semi-annual reports of the Company, the Articles, this Prospectus and the key information documents, as well as the issue, redemption and conversion prices are available, free of charge, from the Company, the Management Company, the Distributors and the Information Agents.

No person is authorised to provide information about the Company other than that which is contained in this Prospectus or in the other documents referred to herein and, if given, such statements or representations should not be relied on as having been authorised by the Company.

This Prospectus does not constitute an offer or an invitation to subscribe for Shares in any jurisdiction in which such an offer or invitation is not lawful or in which the person making such offer or invitation is not qualified or in which the person so invited does not fulfil the requirements for such purchase.

This Prospectus may be translated into other languages. In the event of inconsistency or ambiguities in the interpretation of the translated text, the original English version is binding provided that it does not violate applicable local laws.

Investment Restrictions applying to US Persons

The Company is not and will not be registered in the United States under the Investment Company Act of 1940 as amended. The Shares of the Company have not been and will not be registered in the United States under the Securities Act of 1933 as amended ("Securities Act") or under the securities laws of any state of the United States. The Shares made available under this offer may not be directly or indirectly offered or sold in the United States or to or for the benefit of any US Person (as defined in Rule 902 of Regulation S under the Securities Act). Applicants may be required to declare that they are not a US Person and are neither applying for Shares on behalf of any US Person nor acquiring Shares with the intent to sell them to a US Person. Should a Shareholder become a US Person, he may be subject to US withholding taxes and tax reporting.

Table of Contents

I. Directory	4	3. US Tax Withholding and Reporting under FATCA	51
II. Definitions	7	4. PRC Taxation	52
III. General Information on the Company	19	XIV. Conflicts of Interest and Transactions with Connected Parties	55
1. Directors of the Company	19	1. Conflicts of Interest	55
2. Principal Characteristics of the Company	19	2. Transactions with Connected Parties	55
3. Meetings of Shareholders	19	XV. Risk Factors	56
4. Reports to Shareholders	19	1. General Risk Factors applicable to All Sub-Funds unless otherwise stated	56
5. Liquidation and Merger	20	2. Sub-Fund-Specific Risk Factors	63
6. Fight Against Money Laundering and Terrorist Financing	21	3. Sub-Fund-Specific Risk Factors on an Individual Basis	74
7. Data	22	Appendix 1 General Investment Principles, Asset Class Principles and Sub-Funds' Specific Investment Objectives and Investment Restrictions	80
8. Excessive Trading and Market Timing	22	Part A: General Investment Principles applicable to all Sub-Funds ("General Investment Principles")	80
9. Available Documentation	23	Part B: Introduction, Sub-Fund's specific Asset Class Principles and Sub-Funds' individual Investment Objectives and Investment Restrictions	101
10. Internet publications	23	1. Equity Funds	105
11. Benchmark Regulation	23	2. Bond Funds	131
IV. Management of the Company	23	3. Multi Asset Funds	149
1. General	23	4. Funds of Funds	164
2. Central Administration	24	5. Target Maturity Funds	170
3. Portfolio Management	24	6. Alternative Funds	173
V. Depository	24	Appendix 2 Fees and Expenses	182
VI. Distributors	27	Part A	182
VII. Registrar and Transfer Agent	27	Part B Performance Fee	215
VIII. Paying and Information Agents	27	Appendix 3 Sub-Fund Specific Characteristics	220
IX. The Shares	28	Appendix 4 Risk Management Process	232
1. Share Classes	28	Appendix 5 Investment Manager / Sub-Investment Manager / Investment Advisor	240
2. Permitted Investors and Selling Restrictions	28	Appendix 6 Investor Profile and other Provisions / Restrictions or Additional Information	246
3. Types of Shares	30	Appendix 7 Proportions of a Sub-Fund's Net Asset Value Subject to Securities Financing Transactions	294
4. Dealing in Shares	31	Appendix 8 Other Investment Funds Managed by the Management Company	296
5. Subscriptions	32	Appendix 9 Benchmark Regulation & ESMA Register	297
6. Redemptions	33	Appendix 10 Sub-Funds managed in accordance with the Sustainability-related Disclosure Regulation and specific information to be disclosed in accordance with the Taxonomy Regulation	298
7. Conversions	34	Appendix 11 Important Information for Investors	305
8. Transfers	35		
9. Deferral of Redemption and Conversion Requests	35		
10. Income Equalisation	35		
X. Distribution Policy	35		
1. Distribution Shares	35		
2. Accumulation Shares	36		
XI. Net Asset Value Per Share	37		
1. Calculation of NAV per Share	37		
2. Temporary Suspension of the Calculation of NAV and Resulting Suspension of Dealing	39		
XII. Fees and Expenses	40		
1. Fees and Charges Payable by Investors	40		
2. Fees Payable out of the Assets of the Sub-Funds	40		
XIII. Taxation	50		
1. General	50		
2. Luxembourg	50		

I. Directory

Directors of the Company

Silvana Pacitti (Chairperson)
Managing Director
Allianz Global Investors UK Limited
London, GB

Oliver Drissen
Director
Allianz Global Investors GmbH,
Luxembourg Branch
Senningerberg, Luxembourg

Hanna Duer
Independent Director
Writtle, Chelmsford, GB

Carina Feider
Director
Allianz Global Investors GmbH,
Luxembourg Branch
Senningerberg, Luxembourg

Markus Nilles
Director
Allianz Global Investors GmbH,
Luxembourg Branch
Senningerberg, Luxembourg

Dirk Raab
Director
Allianz Capital Partners GmbH,
Luxembourg Branch
Senningerberg, Luxembourg

Management Company and Central Administration

Allianz Global Investors GmbH
Bockenheimer Landstrasse 42 – 44
DE-60323 Frankfurt/Main

Allianz Global Investors GmbH, acting through the Luxembourg Branch
6A, route de Trèves
LU-2633 Senningerberg

Supervisory Board

Tobias C. Pross (Chairperson)
CEO
Allianz Global Investors GmbH
Munich, Germany

Giacomo Campora
CEO Allianz S.p.A
Milan, Italy

Klaus-Dieter Herberg
Allianz Networks Germany
Allianz Global Investors GmbH
Munich, Germany

Prof. Dr. Michael Hüther
Director and Member of the Board
Institut der deutschen Wirtschaft
Cologne, Germany

Dr. Kay Müller
Member of the Management Board
Allianz Asset Management GmbH
Munich, Germany

Laure Poussin
Head of Enterprise Project Management Office, Paris
Allianz Global Investors GmbH, France Branch
Paris, France

Board of Management

Alexandra Auer
Ludovic Lombard
Ingo Mainert

Dr. Thomas Schindler
Petra Trautschold
Birte Trenkner

Investment Manager / Sub-Investment Manager / Investment Advisor

Allianz Global Investors GmbH *
Bockenheimer Landstrasse 42 – 44
DE-60323 Frankfurt/Main

Allianz Global Investors GmbH * acting through the Belgian Branch
Rue de Laeken 35
BE-1000 Bruxelles

Allianz Global Investors GmbH * acting through the Succursale Française (France Branch)
3, Boulevard des Italiens
FR-75002 Paris

Allianz Global Investors GmbH * acting through the Sede Secondaria e Succursale in Italia (Italy Branch)
Via Durini 1
IT-20122 Milan

Allianz Global Investors GmbH * acting through the Netherlands Branch
Coolensingel 139
NL-3012 AG Rotterdam

Allianz Global Investors Asia Pacific Limited *
32/F, 2 Pacific Place,
88 Queensway, Admiralty
Hong Kong

Allianz Global Investors Japan Co., Ltd. *
Ark Hills South Tower 19F
1-4-5 Roppongi, Minato-ku
Tokyo 106-0032
Japan

Allianz Global Investors Singapore Limited *
79 Robinson Road,
#09-03
Singapore 068897

Allianz Global Investors UK Limited *
199 Bishopsgate
GB-London EC2M 3TY

Voya Investment Management Co. LLC
230 Park Avenue
US-New York, NY 10169

* Indicates a member of the Allianz Global Investors Group, a Company of the Allianz Group.

Depository, Fund Accounting and NAV Calculation, Registrar and Transfer Agent

State Street Bank International GmbH, Luxembourg Branch

49, Avenue J.F. Kennedy
LU-1855 Luxembourg

Information Agent in Germany and Main Distributor Europe

Allianz Global Investors GmbH

Bockenheimer Landstraße 42–44
DE-60323 Frankfurt/Main
E-mail: info@allianzgi.de

Distributor in Germany

Commerzbank AG

Kaiserplatz
DE-60261 Frankfurt/Main

Paying and Information Agents

EU-wide

Facilities as described in Article 92 of the UCITS Directive as well as any corresponding information are available on <https://regulatory.allianzgi.com/en/facilities-services>. State Street Bank International GmbH is responsible for the processing of subscription, repurchase and redemption orders and for making relevant payments to Shareholders, including subscription, redemption and repurchase proceeds. Information or payments may be requested via the following address:

State Street Bank International GmbH, Luxembourg Branch

49, Avenue J.F. Kennedy
LU-1855 Luxembourg

The net asset value of the Shares as well as the subscription and redemption prices of the Shares may be obtained at <https://regulatory.allianzgi.com/en/facilities-services>, and from any other source that the Company deems appropriate.

In addition, there are dedicated paying and information agents in the following jurisdictions:

Cyprus

Hellenic Bank Public Company Ltd
Corner 200 Limassol Ave. & Athalassas
CY-2025 Strovolos

Allianz Bank Financial Advisors S.p.A.
Piazza Tre Torri, 3
IT-20145 Milan

France

State Street Bank International GmbH, Paris Branch
23-25 rue Delarivière-Lefoullon
FR-92064 Paris

Banca Monte dei Paschi di Siena S.p.A.
Piazza Salimbeni, 3
IT-53100 Siena

Germany

State Street Bank International GmbH
Brienner Straße 59
D-80333 Munich

CACEIS Bank, Italy Branch
Piazza Cavour 2
IT-20121 Milan

Italy

Allfunds Bank S.A.U. Milan Branch
Via Bocchetto, 6
IT-20123 Milan

Societe Generale Securities Services S.p.A.
Via Benigno Crespi, 19/A - MAC 2
IT-20159 Milan

Luxembourg

State Street Bank International GmbH, Luxembourg Branch
49, Avenue J.F. Kennedy
LU-1855 Luxembourg

Distributors

France

Allianz Global Investors GmbH, Succursale Française
3, Boulevard des Italiens
FR-75113 Paris, Cedex 02

Netherlands

Allianz Global Investors GmbH, Netherlands Branch
P.O. Box 9444
NL-1006 AK Amsterdam

Greece

Allianz Mutual Fund Management Hellas S.A.
110 Athinon Ave, Building C
GR-10442 Athens

Poland

Allianz Polska Services. TFI Allianz Polska S.A.
ul. Rodziny Hiszpańskich 1
PL-02-685 Warszawa

Hungary

Citibank Europe plc, Hungarian Branch Office
Szabadság tér 7
HU-1051 Budapest

Portugal

Banco Electrónico de Serviço Total S.A.
Rua Alexandre Herculano, 38–4 °
PT-1250-011 Lisbon

Italy

Allianz Bank Financial Advisors S.p.A.
Piazza Tre Torri, 3
IT-20145 Milan

Spain

Allianz Global Investors GmbH, Sucursal en España
Serrano 49, 2ª planta
ES-28006 Madrid

Luxembourg

Allianz Global Investors GmbH, Luxembourg Branch
6A, route de Trèves
LU-2633 Senningerberg

Main Distributor Asia

Allianz Global Investors Asia Pacific Limited
32/F, 2 Pacific Place,
88 Queensway, Admiralty
Hong Kong

Main Distributor Switzerland

Allianz Global Investors (Schweiz) AG
Gottfried-Keller-Strasse 5
CH-8001 Zurich

Representative and Paying Agent in Switzerland

BNP Paribas, Paris, Zurich Branch
Selnaustrasse 16
CH-8002 Zurich

Appointment of Austrian Representative to the Tax Authorities in the Republic of Austria

The following financial institution has been appointed the Austrian representative to the tax authorities for certification of distribution-like income as defined in § 186 Paragraph 2 line 2 InvFG:

Deloitte Tax Wirtschaftsprüfungs GmbH
Renngasse 1/Freyung
AT-1010 Vienna

Appointment of Poland Representative

TFI Allianz Polska S.A.
ul. Rodziny Hiszpańskich 1
PL-02-685 Warszawa

UK Facilities Agent and Distributor in the United Kingdom

Allianz Global Investors UK Limited
199 Bishopsgate
GB-London EC2M 3TY

The Prospectus and the key information document, the Articles, the respective annual and semi-annual reports, price information as well as information on the redemption procedure can be obtained free of charge from the above address. Any complaints may be sent to the Complaints Officer at the above address. A copy of our complaints process leaflet is available on request. Eligible complainants may also refer their complaint to the Financial Ombudsman Service if they are not satisfied with the final response from Allianz Global Investors UK Limited.

Independent Auditor

PricewaterhouseCoopers Société cooperative
2, rue Gerhard Mercator
LU-1014 Luxembourg

II. Definitions

ABS/MBS

means asset-backed securities / mortgage-backed securities. ABS and/or MBS may include, but are not limited to, asset-backed commercial papers, collateralised debt obligations, collateralised mortgage obligations, commercial mortgage-backed securities, credit-linked notes, real estate mortgage investment conduits, residential mortgage-backed securities and synthetic collateralised debt obligations. The pools of underlying assets of ABS and/or MBS can include loans (e.g., auto loans, mortgage loans), leases or receivables (such as credit card debt and whole business in the case of ABS and commercial and residential mortgages originating from a regulated and authorised financial institution in the case of MBS), cash flows from aircraft leases, royalty payments and movie revenues.

Accumulation Share(s)

means the Shares in relation to which the income earned thereon is generally not paid out to the Shareholders but remains in the respective Share Class and is reflected in the value of the Accumulation Shares.

AllianzGI

means Allianz Global Investors GmbH.

AllianzGI AP

means Allianz Global Investors Asia Pacific Limited.

AllianzGI Japan

means Allianz Global Investors Japan Co., Ltd.

AllianzGI Singapore

means Allianz Global Investors Singapore Limited.

AllianzGI UK

means Allianz Global Investors UK Limited.

Allianz Group

means Allianz SE including all of its direct and indirect subsidiaries.

Appendix

means an appendix to this Prospectus.

Articles

means the articles of incorporation of the Company dated 9 August 1999, as may be amended from time to time.

Asia/Asian countries

means all countries of the region of East Asia, South Asia, Southeast Asia and Western Asia (including Middle East). Unless otherwise stated in a Sub-Fund's specific Asset Class Principles or in a Sub-Fund's individual Investment Restrictions, Russia and Turkey are considered not to be Asian countries.

Asia-Pacific /Asia-Pacific countries

means all countries of the region of East Asia, South Asia, Southeast Asia, and Oceania. Unless otherwise stated in a Sub-Fund's specific Asset Class Principles or in a Sub-Fund's individual Investment Restrictions, Russia and Turkey are considered not to be Asia-Pacific countries.

AUD

means the official currency of Australia.

Base Currency

means the currency of denomination of a Sub-Fund as stated in Appendix 3.

Benchmark Regulation

means Regulation (EU) 2016/1011 of the European Parliament and of the Council of 8 June 2016 on indices used as benchmarks in financial instruments and financial contracts or to measure the performance of investment funds and amending Directives 2008/48/EC and 2014/17/EU and Regulation (EU) No 596/2014 (as amended from time to time)

Board or Directors

means the board of directors of the Company listed in the Directory.

Bond Connect

means the program launched in July 2017 for mutual bond market access between Hong Kong and Mainland China established by China Foreign Exchange Trade System & National Interbank Funding Centre (“CFETS”), China Central Depository & Clearing Co., Ltd, Shanghai Clearing House, and Hong Kong Exchanges and Clearing Limited and Central Moneymarkets Unit.

Bond Market

includes, but is not limited to, (i) a regulated market within the meaning of the MiFiD Directive, (ii) another market in a Member State of the EU which is regulated, operates regularly and is recognized and open to the public and/or (iii) an exchange in a non-Member State of the EU or (iv) a market in a Non-Member State of the EU which is regulated, operates regularly and is recognised and open to the public.

BRL

means the official currency of Brazil. This currency may be considered as Hedging Currency only.

Business Day

means each day on which banks and exchanges in Luxembourg are open for business. For the avoidance of doubt, half-closed bank business days in Luxembourg are considered as being closed for business.

CAD

means the official currency of Canada.

Central Administration Agent

means Allianz Global Investors GmbH, acting through the Luxembourg Branch.

CET

means Central European Time.

CEST

means Central European Summer Time.

CHF

means the official currency of Switzerland.

China A-Shares

means shares issued by companies incorporated and listed on stock exchanges (e.g., the Shanghai Stock Exchange and the Shenzhen Stock Exchange), in the PRC, traded in CNY.

China B-Shares

means shares issued by companies incorporated and listed on stock exchanges (e.g., the Shanghai Stock Exchange and the Shenzhen Stock Exchange), in the PRC, traded in USD or HKD.

China H-Shares

means shares issued by companies incorporated in the PRC and listed on the Stock Exchange of Hong Kong, traded in HKD.

CIBM

means the China interbank bond market which is the over-the-counter market for bonds issued and traded in the PRC. A new scheme (the “CIBM Initiative”) was launched in 2016 for foreign institutional investors to access onshore bonds directly through CIBM, complementing existing schemes (e.g., FII Program) and “dim sum” bonds traded in Hong Kong. Under the CIBM Initiative, foreign institutions can trade bonds directly through settlement agent banks in the PRC. There are no specific quota limits imposed on the foreign institutional investor.

Climate Engagement with Outcome Strategy

means a Sub-Fund’s specific investment strategy which is consistent with the principles of the “Climate Engagement with Outcome Strategy”. The description of the detailed investment process and the requirements of the Climate Engagement with Outcome Strategy can be found in the pre-contractual templates for the relevant Sub-Fund which might be found in the attachment to this Prospectus.

CNH

has the meaning ascribed to it in the definition of RMB.

CNY

has the meaning ascribed to it in the definition of RMB.

Company

means Allianz Global Investors Fund which is subject to supervision of CSSF.

Contingent Deferred Sales Charge or CDSC

means an alternative form of sales charge. CDSC (as set out in Appendix 2) is calculated on NAV per Share on redemption for Share Classes B/BT but is not deducted until such Shares are sold.

Conversion Fee

means the fee (if any) charged (as set out in Appendix 2) in respect of a conversion of Shares.

CSSF

means the Commission de Surveillance du Secteur Financier, the Luxembourg securities supervisory authority.

Currency Exposure

means the maximum percentage of a Sub-Fund's assets denominated in a currency as specified in such Sub-Fund's investment restrictions. Such percentage may only be exceeded if the amount exceeding this percentage is hedged against the aforementioned specified currency. Assets and liabilities in the same currency will be set off or netted for the purpose of calculating this limit. Investment instruments that are not denominated in a currency (i.e., no par shares) are considered to be denominated in the currency of the country in which the registered office of the issuer (i.e., the company, for Equities) is located.

CZK

means the official currency of the Czech Republic.

Dealing Application

means any or all of an application to subscribe for Shares, an application to redeem Shares and/or an application to convert Shares, as the context allows.

Dealing Day

means the day on which Shares are issued, redeemed, converted or transferred, which is each Business Day unless otherwise stated in Appendix 3.

Debt Securities

means any security which bears interest, including, but not limited to, government bonds, Money Market Instruments, mortgage bonds and similar foreign asset-backed securities issued by financial institutions, public-sector bonds, floating-rate notes, instruments with loss-absorption features (including, but not limited to contingent convertible bonds), convertible debt securities, corporate bonds, ABS and MBS, as well as other collateralised bonds. Convertible debt securities include, but are not limited to, convertible bonds, bonds with warrants and/or equity warrant bonds. Debt securities also include index certificates and other certificates with a risk profile that typically correlates with the aforementioned assets or with the investment markets to which these assets can be allocated, as well as non-interest-bearing securities such as zero coupon bonds.

Depository

means State Street Bank International GmbH, Luxembourg Branch

Disinvestment Fee

means the fee (if any) charged (as set out in Appendix 2) when redeeming Shares.

Distributors

means each distributor appointed by the Company.

Distribution Share(s)

means Shares which generally distribute net income, or, if applicable, income from disposals or other components.

DKK

means the official currency of Denmark.

Duration

means the Sub-Fund's average cash-value weighted residual maturity of a Sub-Fund's Debt Securities as well as Deposits and Money Market Instruments which should be adhered to by the Sub-Fund's Investment Manager to the most possible extent.

EEA

means the European Economic Area.

Emerging Markets/Emerging Markets Country

means a country which is not classified by the World Bank as a high-income economy (high gross national income per capita).

Equities/Equity

means all equities and similar securities, including but not limited to, preference shares, convertible preference shares, equity warrants, depositary receipts (e.g., American depositary receipts, global depositary receipts), REIT equities, REIT units, equity linked notes, warrants to subscribe for equities. Equities also include index certificates, equity certificates, other comparable certificates and equity baskets as well as assets whose risk profile correlates with the relevant equity or with the investment markets to which these assets can be allocated.

Equity Market

includes, but is not limited to, (i) a regulated market within the meaning of the MiFID Directive, (ii) another market in a Member State of the EU which is regulated, operates regularly and is recognized and open to the public and/or (iii) a stock exchange in a non-Member State of the EU or (iv) a market in a Non-Member State of the EU which is regulated, operates regularly and is recognised and open to the public.

Equity Participation according to Art. 2 Section 8 GITA

includes, but is not limited to, (1) shares in a company admitted to trading on an exchange or on an organized market (which fulfils the criteria of a Regulated Market) or included in such market, and/or (2) shares in a company other than a real estate company that is (i) resident in the EU / EEA and which is not exempt from income taxation there; or (ii) is a resident of a non-EU country and subject to income taxation of at least 15% and/or (3) units of "equity-funds" or "mixed-funds" according to GITA as mentioned in the GITA Restriction with their relevant percentage of a permanent physical investment in an Equity Participation according to Art. 2 Section 8 GITA as disclosed in the respective fund's investment guidelines.

ETF

means Exchange Traded Fund which is a UCITS or UCI and where the issuing capital management company has applied for admission of at least one unit or share class to be traded throughout the day on at least one Regulated Market or multi trading facility (as defined in Art. 14 of Directive 2004/39/EC of the European Parliament and of the Council) with at least one market maker which takes action to ensure that the stock exchange value of its units or shares does not significantly vary from its net asset value or indicative net asset value.

EU

means the European Union.

EU Member State

means a member state of the EU; the states that are contracting parties to the agreement creating the EEA other than the member states of the EU, within the limits set forth by this agreement and related acts, are considered as equivalent to member states of the EU.

EU Savings Directive

means the Council Directive 2003/48/EC on the taxation of savings income, as amended.

EUR or Euro

means the Euro, the official currency of the EU Member States that have adopted the Euro as their common currency.

Europe / European countries

means all countries of the European continent. Unless otherwise stated in a Sub-Fund's specific Asset Class Principles or in a Sub-Fund's individual investment restrictions, Russia and Turkey are considered to be European countries.

Eurozone / Euroland

means the monetary union of the EU Member States that have adopted the Euro as their common currency.

Exit Fee

means the fee (if any) (as set out in Appendix 2) imposed on a redemption of Shares.

FII

means a qualified foreign institutional investor under the FII Regulations.

FII Eligible Securities

means securities and investments permitted to be held or made by a FII under the FII Regulations.

FII Program / FII Regime

means the qualified foreign institutional investors regime in the PRC (including QFII program and RQFII program).

FII Regulations

means the laws and regulations governing the establishment and operation of the qualified foreign institutional investors regime in the PRC (including the qualified foreign institutional investor program ("QFII program") and the RMB qualified foreign institutional investor program ("RQFII program")), as may be promulgated and/or amended from time to time.

GBP

means the official currency of the United Kingdom of Great Britain and Northern Ireland.

GITA

means German Investment Tax Act as amended and effective as of January 1, 2022.

GITA Restriction

means that a Sub-Fund - irrespective of its specific Asset Class Principles, its individual investment objective and its individual investment restrictions which fully continue to apply - is either permanently physically invested with a minimum of at least 51% of its Sub-Fund assets (the amount of Sub-Fund assets according to GITA Restriction is to be determined by the value of Sub-Fund assets without taking into account any liabilities of the Sub-Fund) in an Equity Participation according to Art. 2 Section 8 GITA in order to classify as an "equity-fund" according to GITA ("Alternative 1") or is permanently physically invested with a minimum of at least 25% of its Sub-Fund assets (the amount of Sub-Fund assets according to GITA Restriction is to be determined by the value of Sub-Fund assets without taking into account any liabilities of the Sub-Fund) in an Equity Participation according to Art. 2 Section 8 GITA in order to classify as a "mixed-fund" according to GITA ("Alternative 2").

Grand-Ducal Regulation of 2008

means the Grand-Ducal Regulation of 8 February 2008 relating to certain definitions of the Law.

Green Bonds

are designated Debt Securities intended to encourage sustainability and to support climate-related or other types of special environmental projects. Green Bonds shall be aligned with the four core components of the Green Bond Principles.

Green Bond Principles

are voluntary process guidelines issued by the International Capital Market Association (ICMA) that recommend transparency and disclosure and promote integrity in the development of the Green Bond market by clarifying the approach for issuance of a Green Bond. The Green Bond Principles have the following four core components: (i) use of proceeds, (ii) process for project evaluation and selection, (iii) management of proceeds, and (iv) reporting.

Hedging Currency

means a currency different from the Reference Currency of a Share Class against which such Share Class will be hedged.

High-Yield Investments Type 1

means an investment in Debt Securities which at the time of acquisition has a rating of BB+ or below (Standard & Poor's and Fitch) or of Ba1 or below (Moody's) or the equivalent by another Rating Agency or, if unrated, as determined by the Investment Manager to be of comparable quality. In case of a minimum (maximum) investment limit of High-Yield Investment Type 1 securities according to a Sub-Fund's Investment Restrictions, the lowest (highest) available rating of a Debt Security at acquisition day is decisive for the assessment of the possible acquisition of such Debt Security as High-Yield Investment Type 1. Generally, there is no intention to acquire Debt Securities that are only rated CC, C or D (Standard & Poor's), C, RD or D (Fitch) or Ca or C (Moody's).

High-Yield Investments Type 2

means an investment in Debt Securities which at the time of acquisition has a rating of between BB+ and B- (inclusive) (Standard & Poor's and Fitch) or of between Ba1 and B3 (inclusive) (Moody's) or the equivalent by another Rating Agency or, if unrated, as determined by the Investment Manager to be of comparable quality. In case of a minimum (maximum) investment limit of High-Yield Investment Type 2 securities according to a Sub-Fund's Investment Restrictions, the lowest (highest) available rating of a Debt Security at acquisition day is decisive for the assessment of the possible acquisition of such Debt Security as High-Yield Investment Type 2.

HKD

means the official currency of Hong Kong.

Hong Kong

means Hong Kong Special Administrative Region of the People's Republic of China.

Hong Kong Restriction

means that - irrespective of a Sub-Fund's specific Asset Class Principles, its individual investment objective and its individual restrictions which fully continue to apply - (1) a Sub-Fund's net derivative exposure may be max. 50% of its Net Asset Value and (2) to the extent a Sub-Fund invests in Debt Securities, it may not invest more than 10% of its assets in Debt Securities issued by or guaranteed by any single country with a credit rating below Investment Grade or unrated, and (3) to the extent a Sub-Fund is deemed to be a Bond Fund or a Multi-Asset Fund (as defined pursuant to Appendix 1, Part B of this prospectus) it may invest less than 30% of its assets in instruments with loss-absorption features (including contingent convertible bonds, senior non-preferred Debt Securities, instruments issued under the resolution regime for financial institutions and other capital instruments issued by banks or other financial institutions), of which a maximum of 10% of the respective Sub-Fund's assets may be invested in contingent convertible bonds. A "single country" as referred to in sentence 1 Alternative 2 shall include a country, its government, a public or local authority or nationalized industry of that country.

HUF

means the official currency of Hungary.

Independent Auditor

means PricewaterhouseCoopers Société coopérative.

Institutional Investors

means an institutional investor within the meaning of articles 174, 175 and 176 of the Law.

Investment Advisor

means each Investment Advisor appointed (i) by the Management Company acting in its function as a Sub-Fund's Investment Manager or (ii) by another legal entity acting in its function as a Sub-Fund's Investment Manager as listed in Appendix 5.

Investment Grade

means an investment in Debt Securities which at the time of acquisition has a rating of at least BBB- (Standard & Poor's and Fitch) or of at least Baa3 (Moody's) or the equivalent by another Rating Agency or, if unrated, as determined by the Investment Manager to be of comparable quality. If two different ratings with at least one Investment Grade rating for a Debt Security exist, such Debt Security is considered as Investment Grade, if such Debt Security is not included in an investment limit of High-Yield Investment Type 1 and/or Type 2 according to a Sub-Fund's Investment Restriction.

Investment Manager/Sub-Investment Manager

means the Management Company, the Investment Manager and/or the Sub-Investment Manager as listed in Appendix 5.

IOSCO

means the International Organization of Securities Commissions.

JPY

means the official currency of Japan.

KRW

means the official currency of the Republic of Korea. This currency may be considered as Hedging Currency only.

Law

means the Luxembourg Law of 17 December 2010 on undertakings for collective investment, as amended from time to time.

Malaysian Investment Restriction

means that a Sub-Fund will – irrespective of a Sub-Fund's specific Asset Class Principles, its individual investment objective and its individual restrictions which fully continue to apply – ensure – (i) if such Sub-Fund invests in internal Target Funds – that there is no crossholding between the Sub-Fund and the respective internal Target Fund, and does (ii) only raise short-term loans of up to 10% of Sub-Fund's net assets, provided the Depository agrees to the borrowing and the terms of the relevant loan, and the relevant loan's maturity does not exceed one month.

Management Company

means Allianz Global Investors GmbH which is subject to the supervision of Bundesanstalt für Finanzdienstleistungsaufsicht, the German securities supervisory authority.

Mémorial

means the Mémorial C, Recueil des Sociétés et Associations.

MBS

means mortgage-backed securities. For further information it is referred to the definition of "ABS/MBS".

MiFiD

means Directive 2014/65/EU of the European Parliament and of the Council of 15 May 2014 on markets in financial instruments and amending Directive 2002/92/EC and Directive 2011/61/EU.

Money Market Instruments

means Debt Securities and other instruments with short-term maturities (included, but not limited to treasury bills, certificates of deposits, commercial papers and bankers' acceptance etc.) at the time of acquisition.

Multi Asset Sustainability Strategy

means a Sub-Fund's specific investment strategy which is consistent with the principles of the "Multi Asset Sustainability Strategy". The description of the detailed investment process and the requirements of the Multi Asset Sustainability Strategy can be found in the pre-contractual templates for the relevant Sub-Fund which might be found in the attachment to this Prospectus.

MXN

means the official currency of Mexico.

Net Asset Value or NAV

means the asset value determined pursuant to Section XI.

Net Asset Value per Share or NAV per Share

is as defined in Section XI, headed "Net Asset Value Per Share".

NOK

means the official currency of Norway.

Nominee

means Allianz Global Investors Nominee Services Limited.

NZD

means the official currency of New Zealand.

OECD

means the Organisation for Economic Cooperation and Development.

Paying and Information Agent(s)

means any paying and information agent(s) appointed by the Company.

PAI Indicator(s)

are various indicators which intend to show the material or likely to be material impact of investment decisions on Sustainability Factors. PAI Indicators include, but are not limited to, greenhouse gas emissions, biodiversity, water, waste as well as social and employee matters for corporate issuers, and, where relevant, an indicator applicable to investments in securities of sovereign issuers. PAI indicators are used to measure how issuers negatively impact Sustainability Factors.

PEA (Plan d'Épargne en Actions)

means that a Sub-Fund - irrespective of its specific Asset Class Principles, its individual investment objective and its individual investment restrictions which fully continue to apply – is permanently physically invested with a minimum of at least 75% of its Sub-Fund assets in Equities of corporate issuers with their registered office in an EU Member State and/or in the EEA that has signed a tax agreement with France

PEA-PME (Plan d'Épargne en Actions destiné au financement des PME et ETI)

means that a Sub-Fund - irrespective of its specific Asset Class Principles, its individual investment objective and its individual investment restrictions which fully continue to apply – is permanently physically invested with a minimum of at least 75% of its Sub-Fund assets in Equities of corporate issuers (i) with their registered office in an EU Member State and/or in the EEA that has signed a tax agreement with France, (ii) having less than 5,000 employees, (iii) having an annual turnover of less than EUR 1,5 billion or an annual total balance of less than EUR 2,0 billion, and, (iv) for the case that Equities of such companies are listed on a Regulated Market, its market capitalisation must not exceed EUR 1,0 billion and no third legal entity must hold more than 25% of its capital and is therefore PEA-PME (Plan d'Épargne en Actions destiné au financement des PME et ETI) eligible in France.

PLN

means the official currency of Poland.

PRC

means the People's Republic of China, excluding the Hong Kong Special Administrative Region, the Macau Special Administrative Region and Taiwan.

PRC Broker

means Brokers in PRC appointed by a FII.

PRC Depositary

means depositaries (i.e., local custodians) in PRC appointed by a FII.

Prospectus

means the prospectus of the Company in the currently valid version in accordance with the Law.

Rating Agencies

means Standard & Poor's, Moody's, Fitch, Bank of America and any other national and/or international recognised statistical rating organisation.

Redemption Fee

means the fee (if any) charged (as set out in Appendix 2) when redeeming Shares.

Redemption Price

means the Redemption Price per Share of a Share Class which corresponds to the Net Asset Value per Share of the relevant Share Class less the Redemption Fee and/or the Disinvestment Fee, if applicable.

Reference Currency

means the currency in which the Net Asset Value per Share of a Share Class is calculated.

Register

means the register of Shareholders.

Registrar and Transfer Agent

means State Street Bank International GmbH, Luxembourg Branch

Regulated Market

means each regulated market or stock exchange in any country that, as defined in Article 41(1) of the Law, operates regularly, is recognised and is open to the public.

REIT

means a real estate investment trust, which is a legal entity whose business purpose is oriented toward the ownership of real estate and/or activities related to the ownership of real estate established as a corporation or a fund (although only closed-ended REITS funds may be acquired by a Sub-Fund). A REIT may issue (depending on its legal form of its establishment as a corporation or a fund) either equities ("REIT equities") or units ("REIT units").

RMB

means the Chinese Renminbi, the official currency of the PRC and, unless the context otherwise requires, the term "RMB" refers to offshore Chinese Renminbi ("CNH") traded offshore in Hong Kong or markets outside the PRC and not to onshore Chinese Renminbi ("CNY").

RESA

means Recueil Electronique des Sociétés et Associations.

Science-Based Target initiative (SBTi)

means a partnership between the Carbon Disclosure Project (CDP), the United Nations Global Compact, the World Resources Institute (WRI), and the Worldwide Fund for Nature (WWF) that aims to improve sustainability outcomes worldwide. Issuers taking part to the SBTi initiative commit defined targets to reduce greenhouse gas (GHG) emissions in line with the agreement as of April 2016 within the United Nations Framework Convention on Climate Change (UNFCCC), on climate change mitigation, adaptation, and finance (the "Paris Agreement").

SDG or SDGs

means Sustainable Development Goals which are a collection of various global goals set by the United Nations General Assembly.

The seventeen SDGs currently are:

- (No. 1) No Poverty
- (No. 2) Zero Hunger
- (No. 3) Good Health and Well-Being
- (No. 4) Quality Education
- (No. 5) Gender Equality
- (No. 6) Clean Water and Sanitation
- (No. 7) Affordable and Clean Energy
- (No. 8) Decent Work and Economic Growth
- (No. 9) Industry, Innovation and Infrastructure
- (No. 10) Reduced Inequalities
- (No. 11) Sustainable Cities and Communities
- (No. 12) Responsible Consumption and Production
- (No. 13) Climate Action
- (No. 14) Life Below Water
- (No. 15) Life on Land
- (No. 16) Peace, Justice and Strong Institutions
- (No. 17) Partnership for the Goals

as stipulated by the United Nations General Assembly under www.un.org/sustainabledevelopment from time to time.

SDG-Aligned Strategy

means a Sub-Fund's specific investment strategy which has its focus in securities of companies which, in the opinion of the Investment Manager, are part and/or are enablers of sectors and/or themes, such as the achievement of one or more of the SDGs or other comparable societal goals, which the Investment Manager, at its sole discretion, may additionally determine to be similar in nature, and to which the companies contribute to. The description of the detailed investment process and the requirements of the SDG-Aligned Strategy can be found in the pre-contractual templates for the relevant Sub-Fund which might be found in the attachment to this Prospectus.

Securities Financing Transactions Regulation

means Regulation (EU) 2015/2365 of the European Parliament and of the Council of 25 November 2015 on transparency of securities financing transactions and of reuse and amending Regulation (EU) No 648/2012.

SEK

means the official currency of Sweden.

SFDR or Sustainability-related Disclosure Regulation

means Regulation (EU) 2019/2088 of the European Parliament and of the Council of 27 November 2019 on sustainability-related disclosures in the financial services sector.

SFDR Target Fund(s)

means a Target Fund which promotes environmental or social characteristics or having Sustainable Investments as objective pursuant to Article 8 or Article 9 of the Sustainability-related Disclosure Regulation. External SFDR Target Fund(s) might apply additional or other sustainability features and/or exclusion criteria deviating to those applicable for internal SFDR Target Funds as described in this Prospectus.

SFC

means the Securities and Futures Commission of Hong Kong.

SGD

means the official currency of Singapore.

Share

means a Share issued by the Company in respect of a Share Class.

Share Class

means a class of Shares of a Sub-Fund, which may have different characteristics to other classes of Shares (including, but not limited to, charges, fee structures, use of income, persons authorised to invest, minimum investment amount, Reference Currency, currency hedging, Hedging Currency, subscription and redemption procedures).

Shareholder

means a holder of Shares in the Company.

Social Bonds

are designated Debt Securities intended to encourage sustainability and to finance or refinance projects with an identified social objective. Social Bonds meet the principles of Sustainable Responsible Investing (SRI). Social Bonds shall be aligned with the four core components of the Social Bond Principles.

Social Bond Principles

are voluntary process guidelines issued by the International Capital Market Association (ICMA) that recommend transparency and disclosure and promote integrity in the development of the Social Bond market by clarifying the approach for issuance of a Social Bond. The Social Bond Principles have the following four core components: (i) use of proceeds, (ii) process for project evaluation and selection, (iii) management of proceeds, and (iv) reporting.

Social Economy Assets

means assets as defined in Article L333-17-1 of the French labour code (code du travail) as identified by the French Conseil National des Chambres Régionales de l'Economie Sociale et Solidaire (CN CRESS). Issuers of Social Economy Assets, which must reflect (certain) environmental requirements, are recognized by the CN CRESS.

SRI

means Sustainable Responsible Investing

SRI Rating

is an internal rating assessment which is based on SRI Research and assigned to a corporate or a sovereign issuer. Each SRI Rating is therefore based upon the analysis of criteria considering the domains human rights, social, environmental, business behaviour and governance. SRI Ratings may be used to apply negative or positive screens on a Sub-Fund's investment universe in accordance with the objective of the SRI Strategy. While most holdings of Sub-Funds will have a corresponding SRI Rating some investments cannot be rated according to the SRI Research methodology. Examples of instruments not attaining to the SRI Rating include, but are not limited to, cash, Deposits, and non-rated investments.

SRI Research

means the overall process of identifying potential risks as well as potential opportunities of an investment in securities of an issuer related to the analysis of Sustainability Factors. SRI Research data combines external research data (which might have some limitations) with internal analyses. Based on a combination of the results of the external and/or internal analyses of the Sustainability Factors, an internal rating (SRI Rating) is assigned to a corporate or sovereign issuer.

SRI Strategy

means a Sub-Fund's specific investment strategy which is consistent with the objectives of "sustainable, and responsible investment". The description of the detailed investment process and the requirements of the SRI Strategy can be found in the pre-contractual templates for the relevant Sub-Fund which might be found in the attachment to this Prospectus.

SRI Strategy Type A

means that a Sub-Fund's investment management follows the SRI Strategy – as far as the SRI Strategy's minimum exclusion criteria are not concerned – by using stricter exclusion criteria than the SRI strategy. The description of the detailed investment process and the requirements of the SRI Strategy Type A can be found in the pre-contractual templates for the relevant Sub-Fund which might be found in the attachment to this Prospectus.

Stock Connect

means the program which aims to achieve mutual stock market access between PRC and Hong Kong and includes (i) the Shanghai-Hong Kong Stock Connect, a securities trading and clearing links program developed by the Stock Exchange of Hong Kong Limited ("SEHK"), Shanghai Stock Exchange ("SSE"), China Securities Depository and Clearing Corporation Limited ("ChinaClear") and Hong Kong Securities Clearing Company Limited ("HKSCC"); and (ii) the Shenzhen-Hong Kong Stock Connect, a securities trading and clearing links program developed by SEHK, Shenzhen Stock Exchange ("SZSE"), ChinaClear and HKSCC.

Sub-Fund

means each sub-fund of the Company.

Subscription Fee

means the fee (if any) charged (as set out in Appendix 2) when subscribing for Shares.

Subscription Price

means the Subscription Price Per Share means the price per Share of a Share Class, which corresponds to the Net Asset Value per Share of the relevant Share Class plus a Subscription Fee, if applicable.

Sustainability Bonds

are designated Debt Securities intended to encourage sustainability and to finance or refinance a combination of both, green and social projects. Sustainability Bonds shall be aligned with the respective four components of both, the Green Bond Principles, and the Social Bond Principles.

Sustainability-Linked Bonds

are designated Debt Securities intended to encourage sustainability objectives. The issuer of the debt security commits explicitly to future improvements in sustainability outcomes within a predefined timeline. Sustainability-Linked Bonds shall be aligned with the five core components of the Sustainability-Linked Bond Principles.

Sustainability-Linked Bond Principles

are voluntary process guidelines issued by the International Capital Market Association (ICMA) that outline best practices for financial instruments to incorporate forward-looking sustainable outcomes and promote integrity in the development of the Sustainability-Linked Bond market by clarifying the approach for issuance of a Sustainability-Linked Bond. The Sustainability-Linked Bond Principles have the following five core components: (i) Selection of Key Performance Indicators (KPI), (ii) Calibration of Sustainability Performance Targets (SPT), (iii) Bond characteristics, (iv) reporting, and (v) verification.

Sustainability Factors

means environmental, social and employee matters, respect for human rights, anti-corruption, anti-bribery matters, and any other governance matters.

Sustainable Investment

means an investment in an economic activity that, as measured, contributes to an environmental and/or social objectives (investing in business activities that foster positive contribution to sustainable objectives), provided that such investments do not significantly harm any of those objectives and that the investee companies follow good governance practices, in particular with respect to sound management structures, employee relations, remuneration of staff and tax compliance. Environmental and social contributions can be defined e.g., along the UN Sustainable Development Goals, as well as the taxonomy objectives. The computation of the positive contribution for the Sub-Funds is based on a quantitative framework, complemented by qualitative inputs by Sustainability Research. The methodology applied first breaks down a company into its business activities in order to assess whether these activities are providing a positive contribution to environmental and/or social objectives. Following the mapping of business activities, an asset-weighted aggregation on portfolio level is conducted in order to compute a percentage share of positive contribution per portfolio.

Switzerland Restriction

means the Sub-Fund will raise short-term loans pursuant to Appendix 1, Part A, No. 2, second indent, only for the purpose of liquidity management (in particular for redemption requests). Up to 15% of Sub-Fund assets may be invested in alternative assets pursuant to Art. 5 para. 3 BVV3 (Swiss ordinance on the tax deductibility of contributions to recognized forms of benefit schemes) in connection with Art. 55 lit. d) of BVV2 (Swiss ordinance on occupational old-age, survivors' and invalidity insurance). Alternative assets within this meaning are in particular (1) mortgage-backed securities (MBS) and asset-backed securities (ABS), convertible bonds and bonds with warrants, (2) equities other than those listed under Appendix 1, No. 1, (3) UCITS or UCI which consist predominantly of alternative assets as defined herein, and (4) derivatives if the underlying of the derivative is an alternative asset as defined herein. Deviating to Appendix 1, Part A, No. 3 a), the maximum limit for an issuer of securities and money-market instruments shall be 5% of Sub-Fund's net asset value. The use of derivatives is restricted as per Art. 56a BVV2. In order to comply with these restrictions, the Sub-Fund shall only enter into derivative transactions if the Sub-Fund has sufficient liquid assets to cover its potential obligations under the derivative transactions. The Sub-Fund may not enter into securities repurchase agreements and securities lending agreements pursuant to Appendix 1, Part A, No. 7.

Taiwan Restriction

means that, in respect of a Sub-Fund, (1) the exposure of its open long positions in financial derivative instruments may not exceed 40% of Sub-Fund assets for purposes of efficient portfolio management, unless otherwise exempted by the Taiwan Financial Supervisory Commission (FSC); whereas the total amount of its open short positions in financial derivative instruments may not exceed the total market value of the corresponding securities required to be held by the Sub-Fund for hedging purposes, as stipulated from time to time by the FSC; (2) which is deemed to be a Bond Fund (a) the total amount invested in High-Yield Investments Type 1 or High Yield Investments Type 2 shall not exceed 20% (Debt Securities which qualify as convertible debt securities will not be accounted to this 20%-limit irrespective of their rating) of such Sub-Fund assets, if a Bond Fund's investment in Emerging Markets exceeds 60% of Sub-Fund assets, the Bond Fund's total amount invested in High Yield Investments Type 1 or High Yield Investment Type 2 shall not exceed 40% (Debt Securities which qualify as convertible debt securities will not be accounted to this 40%-limit irrespective of their rating) of such Sub-Fund assets; (b) the total amount of investment in convertible corporate bonds, corporate bonds with warrants, and exchangeable corporate bonds may not exceed 10% of Sub-Fund assets; (3) which is deemed to be a Multi Asset Fund (a) the total amount invested in High Yield Investments Type 1 or High Yield Investments Type 2 shall not exceed 30% (Debt Securities which qualify as convertible debt securities will not be accounted to this 30%-limit irrespective of their rating) of Sub-Fund assets; or such other percentage of its assets as stipulated by the FSC from time to time; (b) the total amount of investments in Equities must be no more than 90% and no less than 10% of Sub-Fund assets; (4) the total amount invested directly in China A-Shares and China interbank bonds (CIBM) shall not exceed 20% of Sub-Fund assets, or such other percentage of its assets as stipulated by the FSC from time to time; and (5) its exposure shall not have Taiwan securities as its main focus respectively as its primary investment area (i.e., more than 50% of Sub-Fund assets).

Target Fund(s)

means any UCITS and/or UCI which is either managed, directly, or indirectly, by the Management Company itself or by any other company with which the Management Company is linked by a substantial direct or indirect participation (internal Target Fund) or any other third company (external Target Fund).

Taxonomy Regulation

means Regulation (EU) 2020/852 of the European Parliament and of the Council of 18 June 2020 of the establishment of a framework to facilitate sustainable investment.

Trading Deadline

means, if any, the relevant time by which a Dealing Application must be received on a Valuation Day to be effected on a particular Valuation Day as set out in Appendix 3.

TRY

means the official currency of the Republic of Turkey.

UCI

means an undertaking for collective investment other than UCITS as defined in the UCITS Directive.

UCITS

means an undertaking for collective investment in transferable securities authorized pursuant to the UCITS Directive.

UCITS Directive

means Directive 2009/65/EC of the European Parliament and of the Council of 13 July 2009 on the coordination of laws, regulations and administrative provisions relating to undertakings for collective investment in transferable securities as amended from time to time.

UCITS Regulation

means Commission Delegated Regulation (EU) 2016/438 of 17 December 2015 supplementing Directive 2009/65/EC of the European Parliament and of the Council with regard to obligations of depositaries.

US or United States

means the United States of America, its territories and possessions, any state of the United States and the District of Columbia.

US Person

means any person that is a United States Person within the meaning of Rule 902 of Regulation S under the United States Securities Act of 1933, as the definition of such term may be changed from time to time by legislation, rules, regulations or judicial or administrative agency interpretations.

USD

means the official currency of the United States of America.

Valuation Day

means each day on which the Net Asset Value per Share of a Class of Shares is calculated; if the Share value is determined more than once on a single Valuation Day, each of these times is considered to be a valuation time during that Valuation Day. A Valuation Day will include each Business Day, unless otherwise stated in Appendix 3.

VAG Investment Restriction

means that a Sub-Fund to the extent it invests - irrespective of its specific Asset Class Principles, its individual investment objective and its individual investment restrictions which fully continue to apply - in (1) ABS/MBS may only invest in ABS/MBS which at the time of acquisition have a rating of at least BBB- (Standard & Poor's and Fitch) or of at least Baa3 (Moody's) or the equivalent by another Rating Agency or, if unrated, as determined by the Investment Manager to be of comparable quality, and which are admitted to or included in an official market or if the issuer has its registered offices in a contracting state to the Agreement on the EEA or a full member State to the OECD and to the extent it invests in (2) Debt Securities (excluding ABS/MBS) may only invest in Debt Securities which at the time acquisition have a rating of at least B- (Standard & Poor's and Fitch) or of at least B3 (Moody's) or the equivalent by another Rating Agency or, if unrated, as determined by the Investment Manager to be of comparable quality. In addition, VAG Investment Restriction means that for the case that two different ratings exist the lower rating will be relevant. If three or more different ratings exist, the second-highest rating will be relevant. An internal rating by the Investment Manager can only be considered if such internal rating complies with requirements as set out in the BaFin circular 11/2017 (VA). Assets as mentioned in sentence 1 which have been downgraded below the minimum rating as mentioned in sentence 1, must not exceed 3% of Sub-fund assets. If assets as described in the aforementioned sentence exceed 3% of the Sub-fund assets, they must be sold within six months from the day on which the exceeding of the 3% threshold took place, but only to the extent such assets exceed 3% of Sub-fund assets. Investment restrictions which are related to a specific VAG investor are not covered by the VAG Investment Restriction.

Voya IM

means Voya Investment Management Co. LLC.

ZAR

means the official currency of South Africa.

III. General Information on the Company

1. Directors of the Company

The Directors are responsible for monitoring the daily business activities of the Company.

2. Principal Characteristics of the Company

The Company was incorporated for an unlimited period under the name DRESDNER GLOBAL STRATEGIES FUND as a société anonyme under the laws of the Grand Duchy of Luxembourg and qualifies as an open-ended société d'investissement à capital variable under part I of the Law. The Company changed its name to Allianz Dresdner Global Strategies Fund on 9 December 2002 and to Allianz Global Investors Fund on 8 December 2004.

The deed of incorporation, including the Articles, was published on 16 September 1999 in the Mémorial. The Articles were last amended on 30 January 2014 and published in the Mémorial. All amendments to the Articles have been published in the Mémorial.

If the Articles are amended, such amendments shall be filled with the Luxembourg Trade and Companies' register and published in the RESA.

The Company is registered with the Luxembourg Trade and Companies' register under number B71182. The Company's capital is reported in EUR and is equal to the net assets of the Company. The minimum capital of the Company is EUR 1,250,000, as required by Luxembourg law.

The registered office of the Company is located at the following address: 6A, Route de Trèves, LU-2633 Senningerberg, Grand-Duchy of Luxembourg.

The Company is authorised by the CSSF as a UCITS under the Law.

The Company is an umbrella fund pursuant to Article 181 of the Law and constitutes a single legal entity. Each Sub-Fund also constitutes a single legal entity and is treated as a separate entity in relation to the Shareholders. The assets of a specific Sub-Fund only cover the debts and obligations of that Sub-Fund, even those that exist in relation to third parties.

The Directors have full discretion to issue additional Share Classes in a Sub-Fund or launch additional Sub-Funds with investment objectives that may be similar or different to those of existing Sub-Funds, at any time. This Prospectus will be updated and the key information document will be created accordingly.

3. Meetings of Shareholders

Shareholder meetings are convened in accordance with the Articles and Luxembourg law.

The annual general meeting of Shareholders will be held each year at the Company's registered office at 11.00 a.m. (Luxembourg time) on the fourth Friday of January or, if such day is not a Business Day, on the next Business Day thereafter.

Shareholders of a Sub-Fund or of a Share Class may at any time call a general meeting of that Sub-Fund or Share Class, at which they may only make decisions relating to that Sub-Fund or Share Class.

The Directors may define in the convening notice a date 5 days before the general meeting (referred to as "record date") by which the quorum and majority requirements shall be determined in accordance to the Shares outstanding on such record date. The voting rights of the Shareholders shall be determined by the number of Shares held at the record date.

4. Reports to Shareholders

The financial year of the Company is from 1 October to 30 September each year. The Company will issue an audited annual report within four months after the end of the financial year and an un-audited semi-annual report within two months after the end of the period to which it refers.

Copies of the reports may be obtained free of charge at the registered office of the Company, at the Distributors or the Paying and Information Agents.

The consolidated financial statements of the Company are prepared in EUR. For this purpose, if the accounts of a Sub-Fund are not expressed in EUR, such accounts shall be converted into EUR.

5. Liquidation and Merger

5.1 The Company

Liquidation

The Company may, at any time, be dissolved by resolution of the general meeting of Shareholders, subject to the quorum and majority requirements set out in the Articles.

If the Company's share capital falls below two-thirds of the minimum capital required by law, the Board must refer the matter of the dissolution to a general meeting of Shareholders, deliberating without any quorum and deciding by a simple majority of the Shares represented at the meeting.

If the Company's share capital is less than a quarter of the minimum capital required by law, the Board must refer the matter of dissolution of the Company to a general meeting of Shareholders, deliberating without any quorum; the dissolution may be decided by Shareholders holding a quarter of the Shares represented at the meeting.

Dissolution will be carried out by one or more liquidators, who may be individuals or legal entities, appointed at the general meeting of Shareholders. The scope of their appointment, along with their fees, shall also be determined at this meeting.

Liquidation proceeds allocated to a Share Class will be paid out to the Shareholders in that Class in proportion to their shareholdings in the respective Share Class.

If the Company is liquidated (for whatever reason), the completion of the liquidation of the Company must, in principle, take place within a period of 9 months from the date of the Board decision authorising the liquidation. Where the liquidation of the Company cannot be fully completed within a period of 9 months, a written request for exemption shall be submitted to the CSSF, detailing the reasons why the liquidation cannot be completed. Any corresponding payment of liquidation proceeds will take place in accordance with the relevant laws. Any funds to which Shareholders are entitled upon the liquidation of the Company and which are not claimed by those entitled thereto prior to the close of the liquidation process shall be deposited for the persons entitled thereto with the Caisse de Consignation in Luxembourg in accordance with the Law.

Merger

In the case the Company is involved in a merger as the merging fund, and hence ceases to exist, the general meeting of the Shareholders of the Company, rather than the Board, has to approve, and decide on the effective date of, such merger by a resolution adopted with no quorum requirement and at a simple majority of the votes cast at such meeting.

5.2 Sub-Funds/Share Classes

Liquidation

- (1) If the assets of a Sub-Fund fall below the amount that the Board considers to be a minimum amount for the economically efficient management of the Sub-Fund, or if the Sub-Fund does not reach this minimum amount or if a substantial change in the political, economic or monetary situation arises, the Board may force redemption of all Shares in the Sub-Fund affected at the Net Asset Value per Share on the Dealing Day following the day on which this decision by the Board enters into force (while taking into account the actual prices achieved and the necessary costs of disposal of the assets).

The Company must inform the Shareholders in writing of the reasons and the redemption procedure before the mandatory redemption enters into force: Registered Shareholders will be notified in writing; holders of bearer Shares will be informed through publication of a notice in newspapers to be determined by the Board or in electronic media as determined in this Prospectus if the Company does not know the names and addresses of the Shareholders. If no other decision is made in the interest of or for purposes of equal treatment of the Shareholders, the Shareholders in the Sub-Fund affected may request the redemption or conversion of their Shares at no charge before the date of the mandatory redemption (while taking into account the actual prices achieved and the necessary costs of disposal of the assets).

Under the same circumstances as provided above, the Board may decide to force redemption of all Shares in any Share Class.

- (2) Notwithstanding the powers conferred upon the Board in paragraph (1) above, the general meeting of Shareholders of one or all Share Classes issued in a Sub-Fund may decide, acting on a proposal of the Board and even for scenarios other than economically efficient management mentioned in paragraph (1) of this Article, to redeem all Shares of one or all Share Classes issued in a Sub-Fund and pay out to the Shareholders the Net Asset Value of the Shares on the Dealing Day following the day on which such decision enters into force (while taking into account the actual prices achieved and the necessary costs of disposal of the assets). At this general meeting, there is no minimum number of Shareholders required to form a quorum. The decision is reached with a simple majority of the Shares present or represented at this meeting.
- (3) Unclaimed proceeds that have not been paid out to the corresponding authorised persons after the redemption is carried out are deposited with the Depositary for the duration of the liquidation period. After this time, the unclaimed proceeds are transferred to the Caisse de Consignation on behalf of the authorised persons and, if unclaimed for the period prescribed in the Luxembourg regulations about the Caisse de Consignation, will be forfeited.
- (4) All redeemed Shares will be cancelled.
- (5) The completion of the liquidation of a Sub-Fund or a Share Class must, in principle, take place within a period of 9 months from the date of the Board decision authorising the liquidation. Where the liquidation of Sub-Fund or a Share Class cannot be fully completed within a period of 9 months, a written request for exemption shall be submitted to the CSSF detailing the reasons why the liquidation cannot be completed.

Merger

- (1) The Board may decide to merge the assets of one or all Share Classes issued in a Sub-Fund (the "Merging Sub-Fund") with any of the following (each a "Receiving Fund"):
 - (i) another Sub-Fund,
 - (ii) another Share Class of the same Sub-Fund,
 - (iii) another UCITS, or
 - (iv) another sub-fund or share class of another UCITSand to rename the Shares of the Merging Sub-Fund as shares of the Receiving Fund (if required after a split or a merger and payment to investors for any differences for fractional shares). The shareholders of the Merging Sub-Fund and Receiving Fund will be informed about the decision to merge in accordance with the Law and applicable Luxembourg regulations at least thirty days before the last date for requesting redemption or, as the case may be, conversion of shares free of charge.
- (2) Notwithstanding the powers of the Board described in paragraph (1) above, the general meeting of Shareholders of a Sub-Fund or of the affected Share Class(es) of the respective Sub-Fund may decide to merge the assets and liabilities of this Sub-Fund (or of the respective Share Class(es), as the case may be) (i) with another Sub-Fund of the Company, (ii) with another Share Class of the same Sub-Fund, (iii) with another UCITS or (iv) with another sub-fund or share class of such an UCITS. There are no quorum requirements for this action, and the merger may be decided upon by a simple majority of the Shares present or represented at the meeting. Such decision of the general meeting of Shareholders is binding to all Shareholders who do not make use of their right to redeem or convert their Shares within the period of thirty days mentioned in paragraph (1) above.

6. Fight Against Money Laundering and Terrorist Financing

The Company and the relevant Distributors will comply with applicable international and Luxembourg laws and regulations regarding the prevention of money laundering and terrorist financing including but not limited to the Luxembourg Law of 5 April 1993 relating to the financial sector (as amended), the Law of 12 November 2004 on the fight against money laundering and terrorist financing, as may be amended from time to time, CSSF Regulation No 12-02 of 14 December 2012 on the fight against money laundering and terrorist financing and relevant CSSF Circulars in the field of the prevention of money laundering and terrorist financing.

As a result of such provisions, the Company has adopted measures to prevent the use of Sub-Funds for money laundering and terrorist financing purposes on a risk-based approach. Such measures include, among others, procedures to identify and verify the identity of investors (and where relevant any beneficial owners), which will require investors, pursuant to initial and ongoing client due diligence requirements, to provide identification documents as determined from time to time. Under the relevant applicable Laws and Regulations, the Company also prepares a business-wide money laundering and terrorist financing risk assessment on an annual basis.

7. Data

Any and all information concerning the investor as an individual or any other data subject (the "Personal Data"), contained in the application form or further collected in the course of the business relationship with the Company will be processed by the Company acting as data controller (the "Controller") in accordance with the provisions of the EU Regulation n°2016/679 of 27 April 2016 on the protection of natural persons with regard to the processing of personal data and on the free movement of such data (the "General Data Protection Regulation") and any applicable data protection law or regulation (collectively the "Data Protection Law").

Investors acknowledge that their Personal Data provided or collected in connection with an investment in the Company may also be processed by the Management Company, Investment Manager, the Depositary, the Central Administration Agent, the Distributor, the Paying Agents, the Registrar and Transfer Agent, the Paying and Information Agent, the Auditor, legal and financial advisers and other service providers of the Company (including its information technology providers) and, any of the foregoing respective agents, delegates, affiliates, subcontractors and/or their successors (collectively the "Service Providers") and assigns in accordance with their roles as Controller or as Processor (as applicable). Some of the foregoing entities may be established outside the European Economic Area (the "EEA") in countries which may not ensure an adequate level of protection of personal data in their local legislation. If such transfer occurs, the Controller is required to ensure that such processing of investors' personal data is in compliance with Data Protection Legislation and, in particular, that appropriate measures are in place such as entering into model contractual clauses (as published by the European Commission).

Insofar as Personal Data provided by the investor concern individuals other than itself, the investor represents that it has authority to provide such Personal Data to the Controller. If the investor is not a natural person, it must undertake to (i) inform any other data subject about the processing of its Personal Data and their related rights and (ii) where necessary and appropriate, obtain in advance any consent that may be required for the processing of such Personal Data.

Such Personal Data will be processed to manage and administer an investor's holding in the Company and performing the related services. Personal Data will also be processed for the purposes of fraud prevention such as anti-money laundering and counter-terrorist financing identification and reporting, tax identification and reporting (including but not limited to compliance with the CRS Law, FATCA) or similar laws and regulations (e.g., on OECD level).

Given the nature of registered Shares, the Company reserves the right to refuse to issue Shares to investors who do not provide the appropriate information on personal data (including records of their transactions) to the Registrar and Transfer Agent.

Personal Data will not be held for longer than necessary with regard to the purposes for which it is processed, subject to applicable legal minimum retention periods.

More details regarding the purposes of such processing, the different roles of the recipients of the Investor's personal data, the affected categories of personal data and the Investors' rights with regard to such personal data as well as any other information required by Data Protection Law can be found in the privacy notice accessible under the following link: <https://regulatory.allianzgi.com/gdpr>.

8. Excessive Trading and Market Timing

Shares may not be acquired for the purposes of market timing or other similar practices. The Company expressly reserves the right to take necessary measures to protect other investors from market timing or similar practices.

9. Available Documentation

The following documents may be obtained free of charge at the registered office of the Company, at the headquarters and Luxembourg branch of the Management Company as well as at the offices of the Distributors and Paying and Information Agents during normal business hours on each business day:

- (1) the Articles and any amendments thereto,
- (2) the management agreement between the Company and the Management Company,
- (3) the central administration agreement between the Company and the Central Administration Agent,
- (4) the depositary agreement between the Company and the Depositary,
- (5) the paying and information agent agreements between the Company or the Management Company and the Paying and Information Agents,
- (6) the investment management agreement between the Management Company and the Investment Manager,
- (7) the latest reports and financial statements,
- (8) the latest Prospectus, and
- (9) the latest key information documents.

10. Internet publications

Any shareholder communication for each Sub-Fund – if permitted under the laws and regulations of any jurisdiction in which Sub-Funds of the Company are registered for public distribution – may exclusively be made on <https://regulatory.allianzgi.com>. In particular, this does not apply to (i) a liquidation or merger of Sub-Funds/Share Classes according to the Law or (ii) any other measure the Articles and/or Luxembourg law are referring to or (iii) any other measure as instructed by the CSSF.

11. Benchmark Regulation

Under the Benchmark Regulation, ESMA publishes and maintains a public register (“ESMA Register”) that contains the consolidated list of EU administrators and third country benchmarks, in accordance with Article 36 of the Benchmarks Regulation. A Sub-Fund may use a benchmark in the European Union if the EU administrator or if the benchmark appears in the ESMA Register or if it is exempted according to Article 2 (2) of the Benchmark Regulation, such as, for example, benchmarks provided by EU and non-EU central banks. Further, certain third country benchmarks are eligible even though they do not appear in the ESMA Register as benefiting from a transitional provision under Article 51.5 of the Benchmark Regulation.

Appendix 9 lists EU administrators and administrators of third country benchmarks if the benchmark is mentioned in Appendix 1, Part B, and/or in Appendix 2, Part B and/or in Appendix 4 of this Prospectus.

The Management Company maintains written plans setting out the actions that will be taken in the event that a benchmark materially changes or ceases to be provided. Such written plans may be obtained, free of charge upon request, at the registered office of the Company or from the Management Company.

IV. Management of the Company

1. General

The Company has appointed Allianz Global Investors GmbH to act as its management company (the “Management Company”) within the meaning of the Law.

The Management Company is responsible, subject to the supervision of the Directors, for the provision of investment management services, administrative services, and marketing services to the Company.

The Management Company is an investment management company within the meaning of the German Investment Code and was incorporated as a limited liability company (Gesellschaft mit beschränkter Haftung) under the laws of the Federal Republic of Germany in 1955. As of 31 December 2021, its subscribed and paid-up capital amounted to EUR 49,900,900.00.

From time to time, the Management Company may carry on its activities through one or more of its branches located in jurisdictions across Europe.

The Management Company may delegate certain services in connection with currency and duration monitoring as well as trading to third parties.

At its own expense, the Management Company has delegated the preparation of risk figures, performance figures and Sub-Fund structural data to IDS GmbH – Analysis and Reporting Services, Munich, Germany, who may in turn be assisted by third parties.

Sales commissions and trail commissions may be paid to sales partners and, in compliance with Luxembourg law, reimbursements may be granted to investors from the All-in-Fee as well as the performance fee of the Management Company.

2. Central Administration

The Company has appointed the Management Company acting through its Luxembourg Branch as its central administration agent. In this capacity, the Central Administration Agent is responsible for all administrative duties required by Luxembourg law. The responsibilities of the Central Administration Agent also include book-keeping, calculation of the Net Asset Value of the Shares, the processing of applications for subscription, redemption and conversion of Shares, accepting payments, the safekeeping of the register of Shareholders, and preparation and supervision of the mailing of financial statements, reports, notices and other documents to Shareholders.

The Management Company has outsourced to State Street Bank International GmbH, Luxembourg Branch substantial functions of central administration and other duties, such as fund accounting, NAV calculation as well as the function of the registrar and transfer agent. State Street Bank International GmbH, Luxembourg Branch may make use of the services of third parties.

3. Portfolio Management

The Company has appointed the Management Company to carry out the investment management function.

The Management Company may, at its own expense, delegate all or any part of its investment management function to third parties (such as the Investment Managers) for the purpose of efficient management. The Management Company may also consult with third parties such as the Investment Advisors. The Management Company shall retain responsibility, control and coordination of the acts and omissions of any such delegates. Generally, currency hedging for Share Classes is not part of the investment management function.

The Investment Managers will manage the day-to-day business of the portfolio (under the supervision, control and responsibility of the Management Company) and provide other related services in accordance with the terms of this Prospectus, the Articles and the applicable laws.

The Investment Managers, if any, as well as the Sub-Funds for which the Management Company does not delegate investment management but performs this duty internally will be disclosed in Appendix 5. The investment management function may be temporarily carried out directly by the Management Company or any one of its branches under certain conditions (e.g., unavailability of the portfolio manager).

The role of an Investment Advisor is to provide advice, draw-up reports and make recommendations to the Investment Manager or to the Sub-Investment Manager as to the management of a Sub-Fund and advise the Investment Manager or the Sub-Investment Manager in the selection of assets for a portfolio. The Investment Advisor will, at all times, provide its services in accordance with the terms of this Prospectus, the Articles and the applicable laws. Investment Advisors whose fees will be paid out of a Sub-Fund's assets will be disclosed in Appendix 5. Other Investment Advisors whose fees will not be paid out of a Sub-Fund's assets will not be disclosed in Appendix 5.

V. Depositary

The Company has appointed State Street Bank International GmbH, acting through its Luxembourg Branch as its Depositary within the meaning of the Law pursuant to the depositary agreement.

State Street Bank International GmbH is a limited liability company organized under the laws of Germany, having its registered office at Brienner Str. 59, 80333 München, Germany and registered with the commercial register court, Munich under number HRB 42872. It is a credit institution supervised by the

European Central Bank (ECB), the German Federal Financial Services Supervisory Authority (BaFin) and the German Central Bank.

State Street Bank International GmbH, Luxembourg Branch is authorized by the CSSF in Luxembourg to act as depositary and is specialized in depositary, fund administration, and related services. State Street Bank International GmbH, Luxembourg Branch is registered in the Luxembourg Commercial and Companies' Register (RCS) under number B148186.

State Street Bank International GmbH is a member of the State Street group of companies having as their ultimate parent State Street Corporation, a US publicly listed company.

Depositary's functions

The relationship between the Company and the Depositary is subject to the terms of the depositary agreement. Under the terms of the depositary agreement, the Depositary is entrusted with following main functions:

- ensuring that the sale, issue, repurchase, redemption and cancellation of Shares are carried out in accordance with applicable law and the Articles of Incorporation.
- ensuring that the value of the Shares is calculated in accordance with applicable law and the Articles of Incorporation.
- carrying out the instructions of the Company unless they conflict with applicable law and the Articles of Incorporation.
- ensuring that in transactions involving the assets of the Company any consideration is remitted within the usual time limits.
- ensuring that the income of the Company is applied in accordance with applicable law and the Articles of Incorporation.
- monitoring of the Company's cash and cash flows
- safe keeping of the Company's assets, including the safekeeping of financial instruments to be held in custody and ownership verification and record keeping in relation to other assets.

Depositary's liability

In carrying out its duties the Depositary shall act honestly, fairly, professionally, independently and solely in the interests of the Company and its Shareholders.

In the event of a loss of a financial instrument held in custody, determined in accordance with the UCITS Directive, and in particular Article 18 of the UCITS Regulation, the Depositary shall return financial instruments of identical type or the corresponding amount to the Company on behalf of the relevant Sub-Fund without undue delay.

The Depositary shall not be liable if it can prove that the loss of a financial instrument held in custody has arisen as a result of an external event beyond its reasonable control, the consequences of which would have been unavoidable despite all reasonable efforts to the contrary pursuant to the UCITS Directive.

In case of a loss of financial instruments held in custody, the Shareholders may invoke the liability of the Depositary directly or indirectly through the Company provided that this does not lead to a duplication of redress or to unequal treatment of the Shareholders

The Depositary will be liable to the Company for all other losses suffered by the Company as a result of the Depositary's negligent or intentional failure to properly fulfil its obligations pursuant to the UCITS Directive.

The Depositary shall not be liable for consequential or indirect or special damages or losses, arising out of or in connection with the performance or non-performance by the Depositary of its duties and obligations.

Delegation

The Depositary has full power to delegate the whole or any part of its safe-keeping functions, but its liability will not be affected by the fact that it has entrusted to a third party some or all of the assets in its safekeeping. The Depositary's liability shall not be affected by any delegation of its safe-keeping functions under the depositary agreement.

The Depositary has delegated those safekeeping duties set out in Article 22(5)(a) of the UCITS Directive to State Street Bank and Trust Company with registered office at One Congress Street, Suite 1, Boston, Massachusetts, USA, whom it has appointed as its global sub-custodian. State Street Bank and Trust

Company as global sub-custodian has appointed local sub-custodians within the State Street Global Custody Network. A list of delegates and sub-delegates is published on the Internet at <https://www.statestreet.com/disclosures-and-disclaimers/lu/subcustodians>.

Information about the safe-keeping functions which have been delegated and the identification of the relevant delegates and sub-delegates are available at the registered office of the Management Company.

Conflicts of Interest

The Depository is part of an international group of companies and businesses that, in the ordinary course of their business, act simultaneously for a large number of clients, as well as for their own account, which may result in actual or potential conflicts. Conflicts of interest arise where the Depository or its affiliates engage in activities under the depositary agreement or under separate contractual or other arrangements. Such activities may include:

- (1) providing nominee, administration, registrar and transfer agency, research, investment management, financial advice and/or other advisory services to the Company,
- (2) engaging in banking, sales and trading transactions including foreign exchange, derivative, broking, market making or other financial transactions with the Company either as principal and in the interests of itself, or for other clients.

In connection with the above activities the Depository or its affiliates:

- (1) will seek to profit from such activities and are entitled to receive and retain any profits or compensation in any form and are not bound to disclose to, the Company, the nature or amount of any such profits or compensation including any fee, charge, commission, revenue share, spread, mark-up, mark-down, interest, rebate, discount, or other benefit received in connection with any such activities,
- (2) may buy, sell, issue, deal with or hold, securities or other financial products or instruments as principal acting in its own interests, the interests of its affiliates or for its other clients,
- (3) may trade in the same or opposite direction to the transactions undertaken, including based upon information in its possession that is not available to the Company,
- (4) may provide the same or similar services to other clients including competitors of the Company,
- (5) may be granted creditors' rights by the Company which it may exercise.

The Company may use an affiliate of the Depository to execute foreign exchange, spot or swap transactions for the account of the relevant Sub-Fund. In such instances the affiliate shall be acting in a principal capacity and not as a broker, agent or fiduciary of the Company. The affiliate will seek to profit from these transactions and is entitled to retain and not disclose any profit to the Company. The affiliate shall enter into such transactions on the terms and conditions agreed with the Company.

Where cash belonging to the Company is deposited with an affiliate being a bank, a potential conflict arises in relation to the interest (if any) which the affiliate may pay or charge to such account and the fees or other benefits which it may derive from holding such cash as banker and not as trustee.

The Investment Manager, Investment Advisor or Management Company may also be a client or counterparty of the Depository or its affiliates.

Potential conflicts that may arise in the Depository's use of sub-custodians include four broad categories:

- (1) conflicts from the sub-custodian selection and asset allocation among multiple sub-custodians influenced by (a) cost factors, including lowest fees charged, fee rebates or similar incentives and (b) broad two-way commercial relationships in which the Depository may act based on the economic value of the broader relationship, in addition to objective evaluation criteria,
- (2) sub-custodians, both affiliated and non-affiliated, act for other clients and in their own proprietary interest, which might conflict with clients' interests,
- (3) sub-custodians, both affiliated and non-affiliated, have only indirect relationships with clients and look to the Depository as its counterparty, which might create incentive for the Depository to act in its self-interest, or other clients' interests to the detriment of clients, and
- (4) sub-custodians may have market-based creditors' rights against client assets that they have an interest in enforcing if not paid for securities transactions.

In carrying out its duties the Depositary shall act honestly, fairly, professionally, independently, and solely in the interests of the Company and its Shareholder.

The depositary has functionally and hierarchically separated the performance of its depositary tasks from its other potentially conflicting tasks. The system of internal controls, the different reporting lines, the allocation of tasks and the management reporting allow potential conflicts of interest and the depositary issues to be properly identified, managed, and monitored.

Additionally, in the context of the Depositary's use of sub-custodians, the Depositary imposes contractual restrictions to address some of the potential conflicts and maintains due diligence and oversight of sub-custodians to ensure a high level of client service by those agents. The Depositary further provides frequent reporting on clients' activity and holdings, with the underlying functions subject to internal and external control audits. Finally, the Depositary internally separates the performance of its custodial tasks from its proprietary activity and follows a Standard of Conduct that requires employees to act ethically, fairly, and transparently with clients.

Up-to-date information on the Depositary, its duties, any conflicts that may arise, the safe-keeping functions delegated by the depositary, the list of delegates and sub-delegates and any conflicts of interest that may arise from such a delegation will be made available to Shareholders on request.

VI. Distributors

The Company may enter into agreements with Distributors to market and place Shares of each of the Sub-Funds in various countries. The Company will not be marketed in the US (subject to some limited exceptions) and in countries where marketing is prohibited.

The Distributors will fulfil all obligations imposed on them by laws, regulations and directives on combating money laundering and terrorist financing and take steps comply with these obligations. The Distributors will be listed in the annual and semi-annual reports.

VII. Registrar and Transfer Agent

The Management Company has appointed State Street Bank International GmbH, Luxembourg Branch as the Company's registrar and transfer agent.

The Registrar and Transfer Agent is responsible for issuing and redeeming Shares, keeping the register of Shareholders and auxiliary services associated therewith.

VIII. Paying and Information Agents

For each country in which Shares of the Company are publicly available, the Company may, at its discretion, appoint a Paying and Information Agent and/or may provide the relevant facilities services as described in Article 92 of the UCITS Directive via its central facilities website

<https://regulatory.allianzgi.com/en/facilities-services>.

In case of the latter alternative, the net asset value of the Shares as well as the subscription and redemption prices of the Shares may be obtained at <https://regulatory.allianzgi.com/en/facilities-services>, and from any other source that the Company deems appropriate.

State Street Bank International GmbH is responsible for the processing of subscription, repurchase and redemption orders and for making relevant payments to Shareholders, including subscription, redemption and repurchase proceeds.

Information or payments may be requested via the following address:

State Street Bank International GmbH, Luxembourg Branch
49, Avenue J.F. Kennedy
LU-1855 Luxembourg

The Paying and Information Agents appointed by the Company are listed in the "Directory" and will be listed in the annual and semi-annual reports.

IX. The Shares

1. Share Classes

The Board may, in its absolute discretion, create additional Sub-Funds and one or more Share Classes within each Sub-Fund. The Company is one single legal entity, and no Sub-Fund has a separate legal identity. However, with regard to third parties, in particular towards the Company's creditors, each Sub-Fund is solely responsible for the liabilities attributable to it.

Each Share Class may have different characteristics including, but not limited to, fee structures, dividend policy, permitted investors, minimum investment amount, Reference Currency and hedging policies. In addition, Share Classes may contain an additional name which can be found in Appendix 6.

"2" to "99" indicates Share Classes which may have different characteristics (including, but not limited to, charges, fee structures, persons authorised to invest, minimum investment amount).

Distribution Shares / Share Classes and Accumulation Shares / Share Classes may be issued for each Sub-Fund. Please see Section X, headed "Distribution Policy" for more details.

Please visit <https://regulatory.allianzgi.com> for a complete list of Share Classes currently available for investment.

The Company draws the investors' attention to the fact that any Shareholder will only be able to fully exercise its rights directly against the Company, notably the right to participate in general meetings of Shareholders, if the Shareholder is registered in his own name in the Register. In cases where a Shareholder invests in the Company through an intermediary investing into the Company in its own name but on behalf of the investor, it may not always be possible for the Shareholder to exercise certain Shareholder rights directly against the Company. Investors should note this and seek their own independent professional advice.

2. Permitted Investors and Selling Restrictions

2.1 Permitted Investors

Certain Share Classes may be offered to only certain investors as set out below:

Share Class	Permitted Investors
B, BT	Only available through certain distributors with prior agreement with the Management Company. No sales load will be payable by the investors on the acquisition of Share Classes B/BT, instead of a sales load a Contingent Deferred Sales Charge ("CDSC") maybe payable to the Management Company or such other party as the Management Company may appoint. Holdings in Share Classes B/BT will be automatically converted into Share Classes A/AT of the same Sub-Fund free of charge on the scheduled conversion date (to be fixed by the Management Company) of each month in which the third anniversary of issue of such Shares occur on the basis of the respective Net Asset Value per share of the relevant Share Classes B/BT and Share Classes A/AT. This conversion may give rise to tax liability for Investors in certain jurisdictions.
E, ET	Investors who at the time the relevant subscription order is received are Singapore Investors utilizing the Central Provident Fund ("CPF") to subscribe into the Fund. Singaporean funds of funds and investment-linked insurance product sub-funds which are included under Singapore's CPF investment scheme, or such other investors as the Management Company may permit. Administrative charges may be deducted by the relevant CPF administrators. Shareholders should check with their CPF administrators for details of the arrangement. Conversions only allowed into Shares of other Share Classes E/ET of the same Sub-Fund or into Shares of Share Classes E/ET of another Sub-Fund.
F, FT	UCITS (or a sub-fund thereof) which qualify as both, a feeder fund in accordance with Art. 58 Section 2 of the UCITS DIRECTIVE and therefore have to invest at least 85% of its assets in another UCITS, and as an Institutional Investor.
I, IT, W, WT, X, XT	May only be acquired by Institutional Investors. Shares of Share Classes I, IT, W, WT, X and XT may not be acquired by natural persons, nor may they be acquired in situations in which the subscriber of the shares is not a natural person but is acting as intermediary for a third-party ultimate beneficiary who is a natural person (unless shares are acquired in the own name of the intermediary which itself is an Institutional Investor). A condition may be set on the issue of shares of these types of Share Classes requiring the prior submission by the investor of a written guarantee to that effect.
P10, PT10	May only be acquired with the consent of the Management Company.
R, RT	May only be acquired with the consent of the Management Company and in addition only by such distributors which according to regulatory requirements (such as discretionary portfolio management

Share Class	Permitted Investors
	and/or independent advice under the MiFID) or based on individual fee arrangements with their clients are not allowed to accept and keep trail commissions. No trail commissions may be paid to any sales partners in relation to any of the available varieties of Share Classes R and RT.
X, XT	At the absolute discretion of the Management Company any fee between the shareholder and the Management Company is individually negotiated.
Y, YT	Providers that render digital financial & investment advisory services to clients ("robo-advisors"). Robo-advisors in the aforementioned meaning are firms specialized in providing financial advice and services via online platforms.

2.2 Additional Requirements to be fulfilled by Certain Permitted Investors

Share Classes where "20" or "21" is part of the Share Class name may be offered to only certain investors which fulfil additional requirements as set out below:

Shares in Share Classes are created within the meaning of Section 10 of the German Investment Tax Act (InvStG) ("tax-free Share Classes"), which differ with regard to the investors who may acquire and hold shares, among other differences, may only be acquired and held by

- (1) German corporations, associations of persons or asset pools which, under the articles of incorporation, the foundation deed or other constitution and on the basis of the actual management, solely and directly serve non-profit, charitable or church purposes within the meaning of Sections 51 to 68 of the German Fiscal Code (AO) and which do not hold the shares in a business operation,
- (2) German foundations under public law, which solely and directly serve non-profit or charitable purposes,
- (3) German legal entities under public law, which solely and directly serve church purposes, and
- (4) non-German investors comparable with the entities described in letters a) to c), with domicile and management in a foreign state providing administrative and debt enforcement assistance.

As proof that the aforementioned conditions have been met, the investor must provide the Company with a valid certificate as specified in Section 9 (1) No. 1 or 2 of the German Investment Tax Act. If the aforementioned conditions are no longer met by an investor, the entity is required to notify this to the Company within one month of the conditions no longer being met. Tax exemption -amounts that the Company receives in connection with management of the respective Sub-Fund, and which are attributable to income from tax-free Share Classes are generally payable to the investors in these tax-free Share Classes. In derogation of this procedure, the Company is entitled to allocate the exemption amounts directly to the fund, in favour of the investors in these tax-free Share Classes; no new shares are issued as a result of this allocation.

Shares in tax-free share classes may not be transferred. If the investor nevertheless transfers shares, the investor is required to notify the Management Company of this within one month of the transfer. This right to redeem the shares exclusively through the Management Company on behalf of the Sub-Fund, in accordance with Article 8 of the Articles of Incorporation, shall remain unaffected.

Shares in tax-free Share Classes may also be acquired and held within the framework of retirement provision or base pension agreements, provided they are certified in accordance with Sections 5 or 5a of the Pension Provision Agreements Certification Act (AltZertG). As proof that the aforementioned condition has been met, the provider of the retirement provision or base pension agreement must notify the Company that it is acquiring the relevant shares of the tax-free Share Class solely within the framework of retirement provision or base pension agreements. If the aforementioned condition is no longer met, the investor is required to notify this to the Company within one month of the conditions no longer being met. Tax exemption amounts that the Company receives in connection with management of the respective Sub-Fund, and which are attributable to income from the tax-free Share Class are generally payable to the provider of the retirement provision or base pension agreement. The provider must reinvest the amounts in favour of the persons who are entitled under the respective retirement provision or base pension agreement. In derogation of this procedure, the Company is entitled to allocate the exemption amounts directly to the fund, in favour of the investors in the tax-free Share Class; no new shares are issued as a result of this allocation. The procedure used is also explained in the sales prospectus.

2.3 Selling Restrictions

The country-specific selling restrictions are set out in Appendix 11.

2.4 Investor Restrictions

The investor restrictions are set out in Appendix 6.

3. Types of Shares

3.1 General

All Shares must be fully paid up prior to their issue.

In respect of each Sub-Fund, Shares may be issued in either registered or bearer form. Shares may or may not be issued in global form. Shares have no nominal value or preferential rights.

Each whole Share is entitled to one vote at any general meeting of Shareholders. However, the exercise of voting rights associated with Shares held by restricted persons may, in relation to those Shares, be refused by the Company at general meetings of Shareholders – please refer to Section III, headed “General Information on the Company”.

Fractional Shares are issued to one thousandth of a Share with smaller fractions being rounded. Fractional Shares confer no voting rights but entitle the Shareholder to participate proportionally in the distribution of net income and in the proceeds of liquidation of the respective Sub-Fund or Share Class.

3.2 Reference Currency

Shares may be issued with a Reference Currency which is different to their Base Currency. The Reference Currency of a Share Class is indicated in the name of the Share Class (e.g., “Share Class A (USD)” indicates “Class A Shares” with USD as the Reference Currency).

The Company may enter into currency hedging transactions in relation to one or more Share Classes. All profits, losses and expenses associated with such transactions will be allocated solely to the relevant Share Class(es).

The table below sets out the different hedging policies applicable to different Share Classes:

Indicator	Characteristics
“H” appears before the Reference Currency	Currency Risk hedged against the Reference Currency e.g., Share Class A (H-USD) with USD as the Reference Currency
“H” appears before the Reference Currency and Hedging Currency	Currency Risk hedged against the Hedging Currency e.g., Share Class A (USD H-JPY) with USD as the Reference Currency and JPY as the Hedging Currency
“H2” appears before the Reference Currency	Base Currency hedged against the Reference Currency e.g., Share Class A (H2-USD) with USD as the Reference Currency (which is different to the Base Currency of the Sub-Fund)
“H2” appears between the Reference Currency and Hedging Currency	Base Currency hedged against the Hedging Currency e.g., Share Class A (USD H2-JPY) with USD as the Reference Currency (which is different to the Base Currency of the Sub-Fund) and JPY as the Hedging Currency
“H3” appears between the Reference Currency and Hedging Currency	Reference Currency hedged against the Hedging Currency e.g., Share Class A (USD H3-JPY) with USD as the Reference Currency (which is different to the Base Currency of the Sub-Fund) and JPY as the Hedging Currency
“H4” appears before the Reference Currency	Currency exposure of the respective benchmark hedged against the Reference Currency e.g., Share Class A (H4-USD) with USD as the Reference Currency Investors still bear the currency risk that may arise from active portfolio management (eg. specific foreign exchange positions).

3.3 Minimum Investment Amount

Subject to the Management Company’s absolute discretion to permit a lower minimum investment, the minimum investment amounts for the investment in the following Share Classes (after deduction of any Subscription Fee) are as set out below:

Share Class	Minimum investment
I/IT	AUD 6 m CAD 6 m CHF 4 m CZK 120 m DKK 30 m EUR 4 m GBP 4 m HKD 40 m HUF 1.2 bn JPY 480 m MXN 100 m NOK 40 m NZD 6 m PLN 16 m RMB 40 m SEK 40 m SGD 8 m TRY 28 m USD 4 m ZAR 60 m

Share Class	Minimum investment
N/NT	AUD 300,000 CAD 300,000 CHF 400,000 CZK 6 m DKK 2 m EUR 200,000 GBP 200,000 HKD 2 m HUF 50 m JPY 40 m MXN 3 m NOK 1.6 m NZD 300,000 PLN 800,000 RMB 2 m SEK 2 m SGD 400,000 TRY 500,000 USD 200,000 ZAR 3 m
P/PT	AUD 4.5 m CAD 4.5 m CHF 3 m CZK 90 m DKK 22.5 m EUR 3 m GBP 3 m HKD 30 m HUF 900 m JPY 360 m MXN 75 m NOK 30 m NZD 4.5 m PLN 12 m RMB 30 m SEK 30 m SGD 6 m TRY 21 m USD 3 m ZAR 45 m
P2/PT2, P23/PT23, P24/PT24, P25/PT25, W/WT, W13/WT13, W14/WT14, W15/WT15	AUD 15 m CAD 15 m CHF 10 m CZK 300 m DKK 75 m EUR 10 m GBP 10 m HKD 100 m HUF 3 bn JPY 1.2 bn MXN 250 m NOK 100 m NZD 15 m PLN 40 m RMB 100 m SEK 100 m SGD 20 m TRY 70 m USD 10 m ZAR 150 m
P3/PT3, P33/PT33, P35/PT35, W2/WT2, W23/WT23, W25/WT25	AUD 75 m CAD 75 m CHF 50 m CZK 1.5 bn DKK 375 m EUR 50 m GBP 50 m HKD 500 m HUF 15 bn JPY 6 bn MXN 1.25 bn NOK 500 m NZD 75 m PLN 200 m RMB 500 m SEK 500 m SGD 100 m TRY 350 m USD 50 m ZAR 750 m
P4/PT4, P43/PT43, P45/PT45, W3/WT3, W33/WT33, W35/WT35	AUD 150 m CAD 150 m CHF 100 m CZK 3 bn DKK 750 m EUR 100 m GBP 100 m HKD 1 bn HUF 30 bn JPY 12 bn MXN 2.5 bn NOK 1 bn NZD 150 m PLN 400 m RMB 1 bn SEK 1 bn SGD 200 m TRY 700 m USD 100 m ZAR 1.5 bn
P5/PT5, P10/PT10, P53/PT53, P55/PT55, W4/WT4, W43/WT43, W45/WT45	AUD 375 m CAD 375 m CHF 250 m CZK 7.5 bn DKK 1875 m EUR 250 m GBP 250 m HKD 2.5 bn HUF 75 bn JPY 30 bn MXN 6.25 bn NOK 2.5 bn NZD 375 m PLN 1 bn RMB 2.5 bn SEK 2.5 bn SGD 500 m TRY 1.75 bn USD 250 m ZAR 3.75 bn
P6/PT6, P63/PT63, P65/PT65, W5/WT5, W53/WT53, W55/WT55	AUD 750 m CAD 750 m CHF 500 m CZK 15 bn DKK 3.75 bn EUR 500 m GBP 500 m HKD 5 bn HUF 150 bn JPY 60 bn MXN 12.5 bn NOK 5 bn NZD 750 m PLN 2 bn RMB 5 bn SEK 5 bn SGD 1 bn TRY 3.5 bn USD 500 m ZAR 7.5 bn
Y/YT	AUD 150 m CAD 150 m CHF 100 m CZK 3 bn DKK 750 m EUR 100 m GBP 100 m HKD 1 bn HUF 30 bn JPY 12 bn MXN 2.5 bn NOK 1 bn NZD 150 m PLN 400 m RMB 1 bn SEK 1 bn SGD 200 m TRY 700 m USD 100 m ZAR 1.5 bn

Subsequent investments for lower amounts are permitted, provided that the combined value held by a Shareholder in any Share Class, after such additional investment and the deduction of any Subscription Fee, is at least equivalent to the minimum investment amount of the relevant Share Class. Where an intermediary invests on behalf of third-party final beneficiaries, such requirement applies to each of the third-party final beneficiaries individually, and a written confirmation from the third-party final beneficiaries to that effect may be required prior to investing.

3.4 Physical Securities

Bearer certificates issued in physical form (“Physical Securities”) will not be issued to individual Shareholders.

4. Dealing in Shares

Dealing Applications received by the respective account keeping entities, the Distributors, the Paying Agents or at the Registrar and Transfer Agent by 11.00 a.m. CET or CEST on any Dealing Day will be dealt with at the applicable Dealing Price determined (but not yet published) on such Dealing Day (the “relevant Dealing Day”). Dealing Applications received after this time will be dealt with at the applicable Dealing Price on the next Dealing Day. Different deadlines for receipt of Dealing Applications may be applicable to individual Sub-Funds. Settlement dates may be no later than the second Valuation Day following the relevant Dealing Day, and the order must always be settled at the relevant Dealing Price at the time the Dealing Application is dealt with.

The Subscription Price must normally be received by the Company in cleared funds and the Redemption Price will normally be paid out within the following timeframes:

- within three Valuation Days after the trade date of a Sub-Fund for a Share Class whose Reference Currency is AUD, CZK, DKK, HKD, HUF, JPY, NZD, PLN, RMB, SGD or ZAR,
- within two Valuation Days after the trade date for a Sub-Fund for Share Classes with a Reference Currency other than one listed in the preceding paragraph.

The Company may with prior notice, if required by a supervisory authority, change the applicable deadline for receipt of subscription monies (or settlement of redemption proceeds, as the case may be), which may be different for different Sub-Funds. However, all payments must be received or settled no later than six Valuation Days after the calculation of the relevant Dealing Price, in the currency of the

relevant Share Class. Any other method of payment requires the prior approval of the Company. All bank charges must be borne by the Shareholders.

The dealing process may vary depending on which agent (e.g., respective account keeping entity, Distributor, Paying Agent or Registrar and Transfer Agent) assists the relevant Shareholder to deal in Shares, which may delay the receipt of the Dealing Application by the Company. If the Dealing Application is made other than through the Registrar and Transfer Agent or the Paying Agents, additional costs may be incurred.

Dealing Applications cannot be withdrawn except when the calculation of the NAV of the relevant Shares is suspended. No Dealing Applications will be dealt with during any such period of suspension. Please refer to Section XI.2., headed "Temporary Suspension of the Calculation of NAV and Resulting Suspension of Dealing" for details.

5. Subscriptions

Shares will be issued on every Dealing Day at the relevant Subscription Price which is determined on each Valuation Day and based on the NAV per Share of the relevant Share Class. Please refer to Section XI.1., headed "Calculation of NAV per Share" for details. Subscription Fees are levied as a percentage of the NAV per Share of a Share Class and are specified in Appendix 2. The Management Company may reduce the Subscription Fee at its absolute discretion. The Subscription Fee accrues to the relevant Distributor and is levied as a percentage of the NAV per Share of the relevant Share Class.

If a Shareholder subscribes for Shares through a particular Distributor, the Distributor may open an account in its own name and have the Shares registered exclusively in its own name or in the name of a nominee. All subsequent dealing applications in respect of the Shares and other instructions must then be made through such Distributor.

The acquisition of Shares of a Share Class whose acquisition is subject to one or more conditions is subject to an appropriately worded written declaration from the ultimate third-party final beneficiary that it complies with the applicable condition(s). The wording of the relevant declaration may be obtained from distributionoperations@allianzgi.com or from the appropriate Distributors and Paying Agents. This declaration must be sent to, and received at, the relevant recipient/address before Shares are acquired.

If subscription amounts are not directly received, or if the Company does not have the full right of disposal of them, the settlement of the subscription will be delayed until such time as the subscription amounts are freely available to the Company unless some other agreement is entered into with the Company or its duly authorised representative.

The subscription price is normally paid in the currency of the share class in question. Upon request of the shareholder, the subscription price may be paid in any other freely convertible currency. All conversion fees due are borne by the shareholder.

The Company may upon application from a subscriber, issue Shares in return for a contribution in kind of securities or other assets, provided that such securities or other assets comply with the investment objectives and investment restrictions of the relevant Sub-Fund whose Shares are being applied for. Such securities or other assets will be valued by the auditors of the Company. The costs of such contribution in kind are borne by the subscriber in question.

The Company reserves the right to reject, wholly or in part, any subscription application on any grounds. In such case, any subscription amounts already paid or any remaining balance will normally be refunded within five Business Days after such a rejection.

The Company also reserves the right to suspend without prior notice the issue of Shares in one or more or all Sub-Funds or in one or more or all Share Classes.

If settlement of subscription amounts is not made within the allocated timeframe, a Subscription Application may lapse and be cancelled at the cost of the relevant investor or their Distributors. The Company may also bring an action against the defaulting investor or their Distributor for (or, if the investor is already a Shareholder, the Company or Management Company may deduct from its Shareholding), any costs or losses incurred from such cancellation. In all cases, any confirmation of

transaction and any money due to the investor/Shareholder will be held by the Management Company without payment of any interest pending receipt of all monies due from the investor/Shareholder.

If the issue of Shares has been suspended, subscription applications are settled on the first Valuation Day after the termination of the suspension unless they have otherwise been revoked in an authorised manner.

6. Redemptions

6.1. The Redemption Process

Shareholders who wish to redeem some or all of their Shares must submit on each Dealing Day a complete written application for redemptions to the respective account keeping entities, the Distributors or the Paying Agents, which will be forwarded to the Registrar and Transfer Agent, or directly to the Registrar and Transfer Agent in the name of the Shareholder.

Shares will be redeemed at the Redemption Price which is determined on each Valuation Day and based on the NAV per Share of the relevant Share Class. Please refer to Section XI.1., headed "Calculation of NAV per Share" for details. Redemption Fees, Exit Fees and Disinvestment Fees are levied as a percentage of the NAV per Share of a Share Class and are specified in Appendix 2. The Management Company may, as its absolute discretion, reduce any such fee. Investors should note that the Redemption Price may be higher or lower than the Subscription Price paid for the relevant Shares.

The Redemption Fees accrue to the Distributors. The Disinvestment Fees and Exit Fees are retained by the respective Sub-Fund. The Exit Fee is calculated as a fixed amount per Share, which is adjusted on a regular basis as set out in Appendix 2 for the relevant Sub-Fund. An Exit Fee will only be charged to Sub-Funds to which a Placement Fee is also applied. A Placement Fee is a fixed amount that is levied on the Sub-Fund and paid out in a single instalment on a date set out in Appendix 2 which is amortized over a pre-defined period. Shareholders who redeem their Shares before the end of the Amortization Period will leave those parts of the paid Placement Fee in the Sub-Fund which are not yet fully amortized. The Exit Fee aims not to harm Shareholders holding the Sub-Fund until or later than the end of the Amortization Period. In certain cases, the Exit Fee may exceed the negative effect on the NAV caused by the redemption of Shares.

The Registrar and Transfer Agent is not obliged to make payment if there are legal provisions, such as exchange control regulations, or other circumstances beyond the Registrar and Transfer Agent's control preventing the settlement of the redemption proceeds.

Settlement of the redemption proceeds is made by electronic bank transfer to the account provided by the Shareholder. The Company does not usually charge a transfer fee for bank transfers. However, the Shareholder's bank may charge such a fee for accepting the payment. Redemption proceeds are normally paid out in the currency of the Share Class in question. Upon request of the shareholder, the redemption price may be paid out in any other freely convertible currency. All conversion fees due are borne by the shareholder.

Where redemption proceeds are settled in kind by the transfer of the Company's securities or other assets, the value of the assets to be transferred must be equivalent to the value of the Shares to be redeemed on the Dealing Day, as valued by the auditors of the Company. The scope and nature of the securities or other assets to be transferred are determined on a reasonable basis without impairing the interests of other investors. The cost of such transfers is borne by the relevant redeeming Shareholder.

6.2 Compulsory Redemption of Shares

If (i) the Company considers ownership of Shares by any person to be contrary to the interests of the Company; or (ii) such ownership is in violation of Luxembourg or other law; or (iii) such ownership would subject the Company to any tax or other financial disadvantage that it would not otherwise incur, the Company may instruct such a Shareholder (a "Restricted Person") in writing to sell all its Shares within 30 calendar days of the Restricted Person receiving such written notice. If the Restricted Person does not comply with the notice, the Company may compulsorily redeem all Shares held by such a Restricted Person in accordance with the following procedure:

- (1) The Company will issue a second notice (the "Purchase Notice") to the relevant Shareholder, which sets out (i) the Shareholder's name, (ii) the Shares to be redeemed, and (iii) the procedure under which the Redemption Price is calculated.

The Purchase Notice will be sent by registered post to the address listed in the Register.

- (2) The Restricted Person's ownership of the designated Shares shall end upon close of business on the date designated in the Purchase Notice, and he shall have no further claim in relation to the Shares or any part thereof, or against the Company or the Company's assets related to the Shares except for the right to repayment of the purchase price of these Shares (the "Purchase Price") without interest. For registered Shares, the name of the Shareholder shall be removed from the Register. For bearer Shares, the certificates that represent the Shares will be cancelled.
- (3) The Purchase Price shall correspond to an amount determined based on the share value of the corresponding Share Class on a Valuation Day, as determined by the Board, less any Redemption Fees. The Purchase Price is (less any Redemption Fees), the lower of (i) the share value calculated before the date of the Purchase Notice and (ii) the share value calculated on the day immediately following the relevant Valuation Day by reference to which the Redemption Price is calculated.
- (4) The Purchase Price will be paid in the currency determined by the Board and deposited at a bank stated in the Purchase Notice after the final determination of the Purchase Price and after receipt of the Share certificate(s) along with any unmatured coupons. After the Purchase Notice has been provided and in accordance with the procedure outlined above, the previous owner has no further claim to the Shares or any part thereof, and the previous owner no longer has any claim against the Company or the Company's assets related to these Shares, with the exception of the right to repayment of the Purchase Price without interest from the named bank. All income from redemptions to which the Restricted Person is entitled may not be claimed after five years from the date stated in the Purchase Notice and shall be forfeited as regards the respective Share Class. The Board is authorised to take all necessary steps to return these amounts and to authorise the implementation of corresponding measures for the Company.
- (5) Any compulsory redemption exercised by the Company shall not be questioned or declared invalid on any grounds concerning the ownership of the relevant Shares, Provided Always that the Company exercised its compulsory redemption powers in good faith.

7. Conversions

A Shareholder may request the conversion of any of his Shares (in whole or in part) into Shares of another Share Class of the same Sub-Fund or into Shares of another Sub-Fund subject to the payment of a Conversion Fee calculated as a percentage of the NAV as listed in Appendix 2 and meeting any minimum investment amounts or any additional requirements applicable to the issue of the new Shares.

An application for the conversion of Shares will be treated in the same way as an application for the redemption of Shares and a simultaneous application for the subscription of Shares.

Conversions may only be effected where it is possible to both redeem the Shares in question and subscribe for the requested Shares (please refer to Sections IX.5. headed "Subscriptions" and IX.6. headed "Redemptions" for details); there will be no partial execution of the application unless there is no possibility of issuing the Shares to be acquired until after the Shares to be converted have been redeemed.

The number of Shares to be issued as a conversion will be calculated in accordance with the following formula:

$$N = \frac{A * B * C}{D}$$

N = the number of the new Shares to be issued (as a result of the conversion).

A = the number of Shares to be converted.

B = the Redemption Price of the Shares to be converted on the respective Dealing Day (taking into consideration any Redemption Fees and/or any Disinvestment Fees due).

C = the currency conversion factor based on the applicable exchange rate (or, where the currencies concerned are the same, C = 1).

D = the Subscription Price of the Shares to be issued on the respective Dealing Day (taking into consideration any Subscription Fees due).

Any Shareholder who undertakes a conversion of Shares may realise a taxable profit or loss, depending on the legal provisions of their country of citizenship, residence, or domicile.

8. Transfers

Any Shareholder is entitled to transfer Shares by an instrument in writing (or using such form as is acceptable to the Company) which is signed by the transferor and the transferee. The transferor's signature must be verified by a person acceptable to the Company. Standard forms are available from the Distributor, the Registrar and Transfer Agent or a Paying Agent. Transfers will not be accepted if, as a result, the Shares are held by a restricted person, any impermissible investor or the holdings are less than the relevant minimum investment amount applicable to the relevant Share Class.

9. Deferral of Redemption and Conversion Requests

If redemption applications (including the redemption portion of conversion applications) exceed 10% of the Shares in issue or NAV of the relevant Sub-Fund on any Dealing Day, the Directors may in their absolute discretion defer some or all of such applications for such period of time (which shall not exceed two Valuation Days) that the Company considers to be in the best interest of that Sub-Fund, provided that, on the first Valuation Day following this period, such deferred redemption and conversion applications will be given priority and settled ahead of newer Applications received after this period.

10. Income Equalisation

The Company applies an income equalisation procedure for the Share Classes, i.e., an equalisation account is maintained which records the portion of income and realised capital gains/losses accrued during the financial year, and which is treated as being included as part of the Subscription Price/Redemption Price. The expenses incurred are accounted for in the calculation of the income equalisation procedure.

The income equalisation procedure is used to account for the movements between (i) income and realised capital gains/losses; and (ii) assets that are caused by net inflows and outflows due to the sale and redemption of Shares. Otherwise, each net inflow of cash would reduce the share of income and realised capital gains/loss on the NAV of a Sub-Fund, and each outflow would increase it.

X. Distribution Policy

1. Distribution Shares

Income available for distribution (distribution amount) is generally calculated according to the net distribution policy (Net Distribution Policy). The distribution amount is calculated by deducting all payable charges, fees, taxes, and other expenses from all income while taking into account the corresponding income equalisation. The Company may determine to distribute (1) realised capital gains and other income (accounting for income equalisation), and (2) unrealised capital gains and (3) capital.

The distribution amount may also be calculated according to the gross distribution policy (Gross Distribution Policy or GDP) by solely taking into account the entire available income (i.e., the gross income). All payable charges, fees, taxes and other expenses from accrued interest, dividends and income received from target fund shares and compensation for securities lending and securities repurchase agreements will be deducted from the capital in accordance with Article 31 of the Law.

The Gross Distribution Policy for Distribution Shares therefore provides for the distribution of essentially all distributable available income (i.e., the gross income without consideration of any costs as outlined above) for a corresponding time period.

Share Classes which distribute income according to the Gross Distribution Policy are named with the additional letter "g".

The distribution amount may also be calculated according to the fixed percentage policy (Fixed Percentage Policy). Such Distribution Shares intend to pay out of variable amount per Share which will be based on a fixed percentage of the Net Asset Value per Share. The distribution amount is calculated based on a fixed percentage applied on the Net Asset Value of the respective share class at the end of the previous month (in case of monthly distributions), the previous financial quarter (in case of quarterly

distributions) or the fiscal year (in case of annual distributions). While the percentage will be applied consistently the distribution amount may vary from month to month due to movement in the Net Asset Value per Share. The fixed percentage for calculation of the distribution amount is determined prior to the first distribution of the relevant Share Class of the relevant Sub-Fund but can be subject to adjustment. Although the fixed distribution percentage is intended to be maintained, it may be subject to amendments under exceptional circumstances (including but not limited to, a drastic drop of the Net Asset Value due to market crash, material market shifts or major crisis) after taking into account various factors, including but not limited to, the portfolio outlook of the relevant Sub-Fund, the risk analysis, the fixed distribution percentage and the Net Asset Value per Share of the relevant Share Class of the relevant Sub-Fund. Shareholders will be notified in case of any change in the fixed distribution percentage. Shareholders should note that fixed payout percentage is not guaranteed.

Share Classes which distribute income according to the Fixed Percentage Policy are named with the additional letter "f".

The distribution amount per share is generally calculated as follows: fixed distribution percentage per annum ÷ distribution frequency over a year × Net Asset Value per Share on the last Dealing Day of the previous month/financial quarter/fiscal year (depending on the frequency of distribution).

Distribution Shares distributing capital have a risk to erode capital. Payment of distribution out of capital, amounts to a return or withdraw of part of an investor's original investment or from any capital gains attributable to that original investment. Any distributions involving payment of dividend out of capital may result in immediate reduction of the Net Asset Value per Share of the share. Distribution Shares applying the Fixed Percentage Policy may have relatively high likelihood to erode capital because the distribution of capital is an inherent element of the determination of the fixed percentage. Shareholders should note that a positive fixed distribution percentage does not imply a high or positive return, as the fixed distribution may be paid out of capital or effectively out of capital.

Please visit <https://regulatory.allianzgi.com> for a complete list of fixed distribution percentages applied to share classes with Fixed Percentage Policy.

All Distribution Shares provides for a distribution unless doing so will result in the net assets of the Company falling below EUR 1,250,000.

Distribution proceeds unclaimed after five years will revert to their respective Share Class(es). No interest accrues on declared distributions.

Share Classes A, C, D, F, I, N, P, R, S, W, X and Y are Distribution Shares the distribution of which will generally be made on 15 December of each year or, if such day is not a Valuation Day, the next applicable Valuation Day unless otherwise stated in Appendix 6, or indicated by the relevant distribution frequency indicators shown in the table below:

Indicator	Distribution Frequency
"M"	Monthly distribution i.e., normally paid out on 15th day of each month. *
"Q"	Quarterly distribution i.e., normally paid out on 15 March, 15 June, 15 September and 15 December. *

* If such day is not a Dealing Day, the distribution date shall be the next Dealing Day.

2. Accumulation Shares

Share Classes T are Accumulation Shares and retain all income (while accounting for income equalisation) less payable charges, fees, taxes and other expenses and reinvest these amounts. No distributions are expected to be paid to holders of Accumulation Shares. Annual accumulation will generally take place on 30 September each year.

Notwithstanding this, Shareholders may, at a general meeting, determine how income and realised capital gains should be treated and may even decide to distribute capital, or provide for cash payments or the issue of bonus shares, or may authorise the Board to make such a decision.

Under no circumstances may distributions be made if doing so would result in the net assets of the Company falling below EUR 1,250,000.

XI. Net Asset Value Per Share

1. Calculation of NAV per Share

The NAV per Share of a Share Class is calculated in the Base Currency of the Sub-Fund. If Shares are issued with other Reference Currencies, such NAV will be published in the currency in which that class of Shares is denominated. On each Valuation Day [at one or more points in time], the NAV per Share is calculated by dividing the net assets of the Sub-Fund by the number of Shares in circulation of the relevant Share Class on the Valuation Day. The net assets of a Share Class are determined by the proportional share of the assets attributable to such a Share Class less the proportional share of the liabilities attributable to a Share Class on the Valuation Day. When distributions are made, the value of the net assets attributable to the Distribution Shares is reduced by the amount of such distributions. The NAV may be rounded up or down to the next applicable currency unit as determined by the Board.

For money-market Sub-Funds, the NAV per Share may be determined plus/less accrued income and expenses expected to be due per Share up to and including the calendar day before the relevant Valuation Day.

If there have been significant changes in the prices on markets in which a significant portion of the assets attributable to a Share Class is traded or listed following the calculation of the NAV, the Company may, in the interests of the Shareholders and the Company, disregard the first valuation and perform a second valuation.

Assets will be valued in accordance with the following principles:

- (1) Cash, term deposits and similar assets are valued at their face value plus interest. If there are significant changes in market conditions, the valuation may be made at the realisation price if the Company can cancel the investment, the cash or similar assets at any time; the realisation price in this sense corresponds to the sales price or the value that must be paid upon cancellation to the Company.
- (2) Investments that are listed or traded on an exchange will be valued based on the latest available trade price on the stock exchange which constitutes the principal market for this investment.
- (3) Investments traded on another Regulated Market are valued at the latest available trade price.
- (4) Securities and money-market instruments whose latest available trade prices do not correspond to appropriate market prices, as well as securities and money-market instruments not officially listed or traded on an exchange or on another Regulated Market, and all other assets, are valued on the basis of their probable sales price, determined prudently and in good faith.
- (5) The liquidation proceeds of futures, forward or options contracts not traded on exchanges or on other Regulated Markets are valued at their net liquidating value determined, pursuant to the policies established by the Directors, on the basis of calculations consistently applied for all types of contracts. The liquidation proceeds of futures, forward or options contracts traded on exchanges or on other Regulated Markets will be based upon the latest available trade price of these contracts on exchanges and Regulated Markets on which the particular futures, forward or options contracts are traded by the Company. If futures, forward or options contracts cannot be liquidated on the day with respect to which net assets are being determined, the basis for determining the liquidating value of such contracts will be such value as the Directors deems fair and reasonable.
- (6) Interest-rate swaps are valued at their market value by reference to the applicable interest rate curve.
- (7) Index and financial instrument-related swaps will be valued at their market value established by reference to the applicable index or financial instrument. The valuation of the index or financial instrument-related swap agreement is based upon the market value of such swap transaction established in good faith pursuant to procedures established by the Directors.
- (8) Target fund units in UCITS or UCIs are valued at the latest determined and obtainable redemption price.

A Sub-Fund may suffer reduction of the Net Asset Value per Share (the "dilution") due to investors purchasing, selling and/or switching in and out of Shares of a Sub-Fund at a price that does not reflect the dealing costs associated with this Sub-Fund's portfolio trades undertaken by the Investment Manager to accommodate cash inflows or outflows.

In order to reduce this impact and to protect Shareholders' interests, a swing pricing mechanism (the "Swing Pricing Mechanism") may be adopted by the Company as part of the general valuation policy.

If on any Valuation Day, the aggregate net investor(s) transactions in Shares of a Sub-Fund exceed a pre-determined threshold, as determined as (i) a percentage of that Sub-Fund's net assets or as (ii) an absolute amount in that Sub-Fund's base currency from time to time by the Company's Board of Directors based on objective criteria, the Net Asset Value per Share may be adjusted upwards or downwards to reflect the costs attributable to net inflows and net outflows respectively (the „Adjustment“). The net inflows and net outflows will be determined by the Company based on the latest available information at the time of calculation of the Net Asset Value.

The Swing Pricing Mechanism may be applied across all Sub-Funds. However, the Swing Pricing Mechanism is currently only applied to certain Sub-Funds which are explicitly mentioned on the webpage <https://regulatory.allianzgi.com>. The extent of the Adjustment will be reset by the Company on a periodic basis to reflect an approximation of current dealing costs. The estimation procedure for the value of the Adjustment captures the main factors causing dealing cost (e.g., bid/ask spreads, transaction related taxes or duties, brokerage fees etc.). Such Price Adjustment may vary from Sub-Fund to Sub-Fund and will not exceed 3% of the original Net Asset Value per Share. The value of the Adjustment is determined by the Management Companies valuation team and approved by an internal swing pricing committee. On a regular basis (minimally twice a year) the value of the Adjustment is reviewed by the Management Company's valuation team and the review results are approved by the swing pricing committee.

The value of the pre-determined threshold, which triggers the application of the adjustment, and the value of the Adjustment are dependent on the prevailing market conditions as measured by several commonly used metrics (e.g., implied volatility, various indices etc.).

Investors are advised that the volatility of the Sub-Fund's Net Asset Value might not reflect the true portfolio performance as a consequence of the application of the Swing Pricing Mechanism. Typically, such Adjustment will increase the Net Asset Value per Share when there are net inflows into the Sub-Fund and decrease the Net Asset Value per Share when there are net outflows. The Net Asset Value per Share of each Share Class in a Sub-Fund will be calculated separately but any Adjustment will, in percentage terms, affect the Net Asset Value per Share of each Share Class in a Sub-Fund identically.

As this Adjustment is related to the inflows and outflows of money from the Sub-Fund it is not possible to accurately predict whether dilution will occur at any future point in time. Consequently, it is also not possible to accurately predict how frequently the Company will need to make such Adjustments. The Directors will retain the discretion in relation to the circumstances under which to make such an Adjustment.

Any performance fee applicable to a Sub-Fund will be charged on the basis of the unswung Net Asset Value.

The price adjustment is available on request from the Management Company at (i) its registered office and/or (ii) on the webpage <https://regulatory.allianzgi.com>.

The value of all assets and liabilities not expressed in the Base Currency of the respective Sub-Fund will be converted into such currency at the latest available exchange rates. If such rates are not available, the rate of exchange will be determined in good faith pursuant to procedures established by the Company.

The Sub-Funds which use a fair value pricing model are set out in Appendix 3.

A fair value pricing model means that the value of certain assets will be adjusted to more accurately reflect their fair value based upon certain criteria. Such adjustments may occur during monitoring periods (as defined by the Directors from time to time) if (i) a single country or several countries equity risk exposure (excluding equity exposure held via target funds) of a Sub-Fund reaches or exceeds a certain trigger level (as defined by the Directors from time to time) on the first Valuation Day of the respective monitoring period and (ii), at the respective Sub-Fund's deadline for receipt of applications, the main stock exchange of the respective countries are already closed during normal course of business. If these

conditions are fulfilled, the value of the portion of Sub-Fund's assets which form part of the respective single country equity risk exposure based on the closing prices of the relevant country's main stock exchange is compared to their estimated value at the moment when the Sub-Fund's NAV is calculated; the estimation is based on the movement of index orientated instruments since the close of business of the respective country's main stock exchange. If such comparison leads to a deviation in Sub-Fund's estimated portion of the NAV by at least a certain trigger level (as defined by the Directors from time to time), the portion of the Sub-Fund's NAV will be adjusted accordingly to the extent that the unadjusted value would not represent their actual value. The process and conduct of fair value adjustment (including any decision to use or not use fair value price) shall be done by the Management Company with due care, skill, and diligence and in good faith, and in consultation with the Depositary.

The Company, at its absolute discretion, may permit some other method of valuation to be used if it considers such valuation to be a more fair valuation of an asset of the Company.

The NAV per Share of each Share Class as well as the Subscription, Redemption and Conversion Price per Share of each Share Class of the individual Sub-Funds are available from the registered office of the Company, the Management Company, the Paying and Information Agents, or the Distributors during normal business hours.

If required, the Share prices of each Share Class will be published for each Sub-Fund in one or more newspapers in the countries in which the Shares are distributed. They may also be obtained from <https://lu.allianzgi.com>, Reuters (ALLIANZGI01) or as otherwise determined by the Company in its absolute discretion. None of the Company, its Distributors, Paying and Information Agents or the Management Company will be liable for any errors or omissions in the published prices.

2. Temporary Suspension of the Calculation of NAV and Resulting Suspension of Dealing

The Company may after consultation with the Depositary, having regard to the best interests of the Shareholders, temporarily suspend the calculation of the NAV per Share of each Sub-Fund or Share Class as well as any dealing in any Shares upon the occurrence of any of the following:

- (1) during any period (with the exception of regular bank holidays) in which any of the principal stock exchanges or other markets on which a substantial portion of the assets of a Sub-Fund is listed or dealt in is closed, or during any period in which trade on such an exchange or market is restricted or suspended, provided that such closure, restriction or suspension affects the valuation of the assets of the Sub-Fund in question listed on such exchange or market; or
- (2) during any period in which, in the view of the Directors, there is an emergency, the result of which is that the sale or valuation of assets of a certain Sub-Fund or Share Class cannot, for all practical purposes, be carried out; or
- (3) at times when there is a breakdown in the means of communication or calculation normally used on an exchange or other market to determine the price or the value of investments of a Sub-Fund or Share Class or to determine the current price or value of investments of the respective Sub-Fund or Share Class; or
- (4) if, for any other reason, the prices for assets of the Company attributable to the Sub-Fund in question or a Share Class cannot be determined rapidly or precisely; or
- (5) during any period in which it is not possible for the Company to repatriate the necessary funds for the redemption of Shares, or in which the transfer of funds from the sale or for the acquisition of investments or for payments resulting from redemptions of Shares cannot be carried out, in the view of the Board, at normal exchange rates; or
- (6) from the time of the announcement of a call by investors for an extraordinary meeting of Shareholders for the purpose of liquidating the Company or for the purpose of carrying out a merger of the Company, a Sub-Fund or a Share Class, or for the purpose of informing investors of the decision by the Board to liquidate Sub-Funds or Share Classes or for the purpose of merging Sub-Funds or Share Classes; or
- (7) during any period in which the valuation of the currency hedges of Sub-Funds or Share Classes whose respective investment objectives and policies make hedging of currencies at the Share Class or Sub-Fund level desirable cannot be adequately carried out or cannot be carried out at all.

Appropriate notice of any such suspension as considered necessary will be published by the Company. The Company may notify Shareholders applying to deal in Shares for which the calculation of NAV has been suspended. Any such suspension in a Share Class has no effect on the calculation of the NAV per Share or the dealing of Shares of other Share Classes.

XII. Fees and Expenses

1. Fees and Charges Payable by Investors

Details of the Sales Charge and the Conversion Fee are set out in Appendix 2. Sales Charges and Conversion Fees are levied or calculated as a percentage of the NAV per Share of each Class. No Redemption Fee is currently levied.

2. Fees Payable out of the Assets of the Sub-Funds

2.1 All-in-Fee Payable to the Management Company

The Company pays all costs to be borne by a Sub-Fund from its assets. The Company pays a fee (the "All-in-Fee") to the Management Company from the assets of the respective Sub-Funds, unless this fee is charged directly to the Shareholder under the terms of a particular Share Class.

The fees of the Investment Managers appointed by the Management Company are paid by the Management Company from its All-in-Fee and, if necessary, from its performance fee.

Provided that it is not charged directly to the Shareholder under the terms of a particular Share Class, the All-in-Fee is accrued daily and charged monthly in arrears on a pro rata basis on the average daily Net Asset Value of the respective Share Class of a Sub-Fund. The amount of the All-in-Fee charged is listed in Appendix 2.

The Management Company shall pay the following expenses out of the All-in-Fee:

- Management Company and Central Administration Agent fees (except for arranging, preparing and executing of securities lending and/or repurchase/reverse repurchase transactions by the Management Company);
- distribution fees,
- the Depositary's administration and custody fees,
- Registrar and Transfer Agent fees,
- Auditor fees,
- Paying and Information Agent(s) fees,
- costs of the preparation (including translation) and dissemination of this Prospectus, key information documents, Articles and the annual, semi-annual and, if any, interim reports and other reports and notifications to Shareholders,
- costs of publishing this Prospectus, key information documents, Articles, annual, semi-annual and, if any, interim reports, other reports and notifications to Shareholders, tax information, as well as the Subscription Price and Redemption Price, and official announcements made to the Shareholders,
- costs of registering the Shares for public distribution and/or the maintenance of such registration,
- costs of preparing Share certificates and, if any, coupons and coupon renewals,
- costs of assessing the Sub-Funds by nationally and internationally recognised rating agencies,
- expenses in connection with the establishment of the Sub-Funds,
- servicing charge in connection with providing distributing-related services to B/BT Share Classes,
- costs related to the use of index names, in particular, licence fees,
- costs and fees incurred by the Company or by third parties authorised by the Company relating to the acquisition, use and maintenance of in-house or third-party computer systems used by the Investment Managers and the Investment Advisors,
- costs related to the direct investment in assets in a country,
- costs related to acting directly as a contracting partner in a market,
- costs and expenses incurred by the Company, the Depositary and third parties authorised by the Company or the Depositary in connection with monitoring of investment limits and restrictions,
- costs for calculating the risk and performance figures and the calculation of performance fees for the Management Company by third parties appointed to do so,

- costs related to obtaining information about general meetings of Shareholders or other meetings and costs related to direct participation or participation via proxies in such meetings, and
- postage, telephone, fax, and telex fees.

The Management Company may, in its absolute discretion, levy a lower All-in-Fee than that mentioned in Appendix 2.

Management expenses and all other regular or recurring expenses may be allocated by the Company to any financial period as may be determined by the Board in its absolute discretion.

2.2 Performance Fee

The Management Company may charge a performance fee to certain Sub-Funds, provided that this fee is not charged directly to the Shareholders under the terms of a Share Class. The amount of the performance fee charged, if any, as well as the benchmark index and method for the calculation of the performance fee are listed in Appendix 2.

Investors are advised that a performance fee may be paid even if the Share price performance is negative.

In addition, the calculation of performance fees is computed net of all costs.

Method A

Any performance fee is up to the performance fee rate (listed in Appendix 2) of the positive amount by which the total of the following items in respect of a Share Class exceeds the return on the benchmark index (over the relevant period):

- (1) the return on investment on the Share Class; and
- (2) the amount of distributions, if any, made during the current financial year.

The Management Company may levy a lower fee at its own discretion. The prices used in calculating the investment results of a Sub-Fund are related as closely as possible in time to the prices underlying the calculation of the index. This may cause such valuation of a Sub-Fund to deviate from the valuation for purposes of determining the Share price on the same day. Depending on the time used as a basis for calculating the index, there may be a delay in taking the performance fee into account in the Net Asset Value of the Share Class in question. Taking into account any negative carry-forward, the performance fee will be calculated on each Valuation Day from the beginning of each financial year, taking into account the current value of the respective Share Class of the Sub-Fund in question and the entire amount will be carried forward on a continuous basis. The total amount carried forward will be set aside and, if it is positive, paid from the Sub-Fund through a charge to the Share Class in question at the end of the financial year. The total amount carried forward and set aside in accordance with the method described above is reduced on Valuation Days on which, according to the above calculation, the adjusted investment results of a Share Class of the Sub-Fund are exceeded by the relevant benchmark index. Negative amounts are carried forward and, if still in existence at the end of the financial year, carried forward into the Sub-Fund's next financial year. In calculating the respective Sub-Fund's performance fee, negative amounts carried forward from the preceding five financial years will be taken into account.

If Shares are redeemed, the corresponding amount of any accrued positive performance fee is to be paid immediately to the Management Company. If the amount of the performance fee resulting from the above calculation is negative when Shares are redeemed, it will be reduced by an amount corresponding to the Shares redeemed.

Method B

Any performance fee is up to the performance fee rate (listed in Appendix 2) of the positive amount by which the total of the following items in respect of a Share Class exceeds the return on the benchmark index (provided that the sum of the last Net Asset Value per Share of the respective Share Class prior to the calculation of the performance fee plus all distributions since the last definition/adjustment of the high watermark exceeds the current high watermark):

- (1) the return on investment on the Share Class; and
- (2) the amount of any distributions made during the current financial year.

The high watermark is the Net Asset Value per Share of the relevant Share Class at the end of the last financial year for which a performance fee for the respective Share Class was actually paid. For these purposes, a performance fee which was paid in a previous financial year because of a redemption of Shares as described below is ignored. The Management Company may levy a lower fee at its own discretion.

Depending on the time used as a basis for calculating the index, there may be a delay in taking the performance fee into account in the Net Asset Value of the Share Class in question. Taking into account any negative carry-forward, the performance fee will be calculated on each Valuation Day from the beginning of each financial year, taking into account the current Net Asset Value of the respective Share Class of the Sub-Fund in question and the entire amount will be carried forward on a continuous basis. The total amount carried forward will be set aside and, if it is positive, paid from the Sub-Fund through a charge to the Share Class in question at the end of the financial year. The total amount carried forward and set aside in accordance with the method described above is reduced on Valuation Days on which, according to the above measure, the adjusted investment results of a Share Class are exceeded by the relevant benchmark index. Furthermore, in case of any Net Asset Value per Share of the respective Share Class plus all distributions since the last definition/adjustment of the high watermark falling below the current high watermark and a current positive total amount carried forward and set aside such current positive amount is reduced to avoid the sum of the Net Asset Value per Share of the relevant Share Class plus all distributions since the last definition/adjustment of the high watermark falling below the high watermark. There is no such reduction to avoid the sum of the Net Asset Value per Share of the respective Share Class plus all distributions since the last definition/adjustment of the high watermark falling below the high watermark which leads to a negative amount carried forward and set aside.

Negative amounts are carried forward, and if still in existence at the end of the financial year, are carried forward into the next financial year. In calculating the respective Sub-Fund's performance fee, negative amounts carried forward on a perpetual basis will be taken into account.

If Shares are redeemed, the corresponding proportion of any accrued positive performance fee is to be paid immediately to the Management Company. If the amount of the performance fee resulting from the above calculation is negative when Shares are redeemed, it will be reduced by an amount corresponding to the Shares redeemed.

If a selected benchmark index lapses, the Company will, at its absolute discretion, replace it with another comparable index.

Performance Fee Illustrations

The below following examples are provided for illustrative purposes only and intended to enhance an investor's understanding of the mechanics of the Performance Fee and the memorandum account for negative accruals. Expenses chargeable to a Sub-Fund, including the All-in-Fee, are ignored for the purpose of these examples. In addition, the examples feature the share class return figures quoted net of all costs.

Method A

Example 1: Positive accrual included in a Sub-Fund's Net Asset Value calculation

Assuming an investment of EUR 50m, i.e., Net Asset Value of the Share Class of EUR 50m and assuming a Participation Rate of 20%.

Day 1	Between the first Valuation Point of the Performance Period and the immediately preceding Valuation Point, the Benchmark Return is equal to +0.1%. In that same period the Share Class Return is +0.3%. The differential return is +0.2% and therefore an initial Performance Fee accrual of EUR 20,000 (i.e., $\text{EUR } 50\text{m} \times 0.2\% \times 20\%$) is included as a liability in the Net Asset Value calculation. The Net Asset Value of the Performance Fee Share Class increases to EUR 50.13m (i.e., EUR 50m investment brought forward from previous Performance Period + EUR 150,000 Share Class Return – EUR 20,000 Performance Fee initial accrual).
Day 2	At the following Valuation Point, the Share Class Return is +0.1%. The Benchmark Return is zero. The differential return is +0.1%, resulting in an increase to the Performance Fee accrual of EUR 10,026 (i.e., $\text{EUR } 50.13\text{m} \times 0.1\% \times 20\%$). The total Performance Fee accrual on Day 2 therefore increases by EUR 10,026, from EUR 20,000 to EUR 30,026. The Net Asset Value of the Performance Fee Share Class is EUR 50.17m (i.e., EUR 50.13m as at previous Valuation Point + EUR 50,130 Share Class Return – EUR 10,026 increase to Performance Fee accrual).

Day 3	<p>On Day 3, the Share Class Return is +0.4%, whilst the Benchmark Return is equal to +0.5%. The differential return is -0.1%, resulting in a decrease to the Performance Fee accrual of EUR 10,034 (i.e., EUR 50.17m x 0.1% x 20%).</p> <p>The total Performance Fee accrual on Day 3, therefore, decreases by EUR 10,034, from EUR 30,026 to EUR 19,992.</p> <p>The Net Asset Value of the Performance Fee Share Class increases to EUR 50.38m (i.e., EUR 50.17m as at previous Valuation Point + EUR 200,680 Share Class Return + EUR 10,034 decrease in Performance Fee accrual).</p> <p>The Net Asset Value of the Performance Fee Share Class at the end of Day 3 therefore comprises:</p> <table border="1" style="width: 100%; border-collapse: collapse;"> <tr> <td style="width: 60%;">Investment on Day 1</td> <td style="text-align: right;">EUR</td> <td style="text-align: right;">50,000,000</td> </tr> <tr> <td>Add: Aggregate of Share Class Returns (Day 1 to Day 3)</td> <td style="text-align: right;">EUR</td> <td style="text-align: right;">400,810</td> </tr> <tr> <td>Less: Performance Fee accrual as at Day 3</td> <td style="text-align: right;">EUR</td> <td style="text-align: right;">-19,992</td> </tr> <tr> <td></td> <td style="text-align: right;">EUR</td> <td style="text-align: right; border-top: 1px solid black;">50,380,818</td> </tr> </table>	Investment on Day 1	EUR	50,000,000	Add: Aggregate of Share Class Returns (Day 1 to Day 3)	EUR	400,810	Less: Performance Fee accrual as at Day 3	EUR	-19,992		EUR	50,380,818
Investment on Day 1	EUR	50,000,000											
Add: Aggregate of Share Class Returns (Day 1 to Day 3)	EUR	400,810											
Less: Performance Fee accrual as at Day 3	EUR	-19,992											
	EUR	50,380,818											
End of Performance Period	<p>Assuming that the movement in the Share Class Return moves in line with the Benchmark Return for the remainder of the financial year, a Performance Fee of EUR 19,992 will be payable to the Management Company for the financial year.</p>												

Example 2: Use of memorandum account for negative accrual

Assuming an investment of EUR 50m, i.e., Net Asset Value of the Share Class of EUR 50m and assuming a Participation Rate of 20%.

Day 1	<p>As in Example 1 above, between the first Valuation Point of the Performance Period and the immediately preceding Valuation Point, the Benchmark Return is equal to +0.1%. In that same period the Share Class Return is +0.3%.</p> <p>The differential return is +0.2%. Therefore, an initial Performance Fee accrual of EUR 20,000 is included as a liability in the Net Asset Value calculation. The Net Asset Value of the Performance Fee Share Class increases to EUR 50.13m.</p>																								
Day 2	<p>On the following day, the Share Class Return is +0.1%, whilst the Benchmark Return is equal to +0.5%. The differential return is -0.4%, resulting in a decrease to the Performance Fee accrual of EUR 40,104 (i.e., EUR 50.13m x 0.4% x 20%).</p> <p>The Performance Fee accrual on Day 2, therefore, reduces from EUR 20,000 to nil. At the same time, a negative accrual of EUR -20,104 is recorded in a memorandum account.</p> <p>The Net Asset Value of the Performance Fee Share Class is EUR 50.20m (i.e., EUR 50.13m + EUR 50,130 Share Class Return + EUR 20,000 decrease in Performance Fee accrual).</p>																								
Day 3	<p>On Day 3, the Share Class Return is +0.2%, whilst the Benchmark Return is +0.1%.</p> <p>The differential return is +0.1%, resulting in an increase in the value of the memorandum accrual of EUR 10,040, (i.e., EUR 50.2m x 0.1% x 20%) from EUR -20,104 to EUR -10,064. No Performance Fee accrual is included in the Net Asset Value calculation as an amount of EUR -10,064 remains recorded on the memorandum account. The Net Asset Value of the Share Class increases to EUR 50.30m (i.e., EUR 50.20m + EUR 100,400 Share Class Return).</p> <p>The Net Asset Value of the Share Class at the end of Day 3 therefore comprises:</p> <table border="1" style="width: 100%; border-collapse: collapse;"> <tr> <td style="width: 60%;">Investment on Day 1</td> <td style="text-align: right;">EUR</td> <td style="text-align: right;">50,000,000</td> </tr> <tr> <td>Add: Aggregate of Share Class Returns (Day 1 to Day 3)</td> <td style="text-align: right;">EUR</td> <td style="text-align: right;">300,530</td> </tr> <tr> <td>Less: Performance Fee accrual as at Day 3</td> <td style="text-align: right;">EUR</td> <td style="text-align: right;">nil</td> </tr> <tr> <td></td> <td style="text-align: right;">EUR</td> <td style="text-align: right; border-top: 1px solid black;">50,300,530</td> </tr> </table> <p>and the memorandum account recording the negative accrual at the end of Day 3 comprises:</p> <table border="1" style="width: 100%; border-collapse: collapse;"> <tr> <td style="width: 60%;">Day 1 movement</td> <td style="text-align: right;">EUR</td> <td style="text-align: right;">nil</td> </tr> <tr> <td>Add: Day 2 movement</td> <td style="text-align: right;">EUR</td> <td style="text-align: right;">-20,104</td> </tr> <tr> <td>Less: Day 3 movement</td> <td style="text-align: right;">EUR</td> <td style="text-align: right;">10,040</td> </tr> <tr> <td></td> <td style="text-align: right;">EUR</td> <td style="text-align: right; border-top: 1px solid black;">-10,064</td> </tr> </table>	Investment on Day 1	EUR	50,000,000	Add: Aggregate of Share Class Returns (Day 1 to Day 3)	EUR	300,530	Less: Performance Fee accrual as at Day 3	EUR	nil		EUR	50,300,530	Day 1 movement	EUR	nil	Add: Day 2 movement	EUR	-20,104	Less: Day 3 movement	EUR	10,040		EUR	-10,064
Investment on Day 1	EUR	50,000,000																							
Add: Aggregate of Share Class Returns (Day 1 to Day 3)	EUR	300,530																							
Less: Performance Fee accrual as at Day 3	EUR	nil																							
	EUR	50,300,530																							
Day 1 movement	EUR	nil																							
Add: Day 2 movement	EUR	-20,104																							
Less: Day 3 movement	EUR	10,040																							
	EUR	-10,064																							
End of Performance Period	<p>Assuming that the Share Class Return moves in line with the Benchmark Return for the remainder of the financial year, the negative memorandum accrual of EUR -10,064 will remain in place and will be carried forward to the next financial year. No Performance Fee will be payable to the Management Company for the current financial year.</p>																								

For the subsequent financial year, on Day 1, assume the Share Class Return is +0.7% while the Benchmark Return is +0.4%. The differential return is +0.3% and the Performance Fee accrual before considering the memorandum account is EUR 30,180 (i.e., EUR 50,300,530 * 0.3% * 20%). As the memorandum account shows the prior year's accrual of EUR -10,064, the effective Performance Fee accrual is EUR 20,116. Assuming that for the rest of that financial year, the share class return moves in line with the Benchmark Return, a performance fee of EUR 20,116 will be payable to the Management Company.

Method B

Example 3: Positive accrual included in Net Asset Value calculation and setting of a new high watermark

Assuming an investment of EUR 50m, i.e., Net Asset Value of the Share Class of EUR 50m and assuming a Participation Rate of 20%. The number of shares issued is assumed to be constant at 50,000 and the current high watermark is 1,000.

Day 1	Between the first Valuation Point of the Performance Period and the immediately preceding Valuation Point, the Benchmark Return is equal to +0.1%. In that same period the Share Class Return is +0.3%. The differential return is +0.2% and, therefore, an initial Performance Fee accrual of EUR 20,000 (i.e., EUR 50m x 0.2% x 20%) is included as a liability in the Net Asset Value calculation. The Net Asset Value of the Performance Fee Share Class increases to EUR 50.13m (i.e., EUR 50m investment brought forward from previous Performance Period + EUR 150,000 Share Class Return – EUR 20,000 Performance Fee initial accrual).												
Day 2	At the following Valuation Point, the Share Class Return is +0.1%. The Benchmark Return is zero. The differential return is +0.1%, resulting in an increase to the Performance Fee accrual of EUR 10,026 (i.e., EUR 50.13m x 0.1% x 20%). The total Performance Fee accrual on Day 2, therefore, increases by EUR 10,026, from EUR 20,000 to EUR 30,026. The Net Asset Value of the Performance Fee Share Class is EUR 50.17m (i.e., EUR 50.13m as at previous Valuation Point + EUR 50,130 Share Class Return – EUR 10,026 increase to the Performance Fee accrual).												
Day 3	On Day 3, the Share Class Return is +0.4%, whilst the Benchmark Return is equal to +0.1%. The differential return is +0.3%, resulting in an increase to the Performance Fee accrual of EUR 30,102 (i.e., EUR 50.17m x 0.3% x 20%). The total Performance Fee accrual on Day 3, therefore, increases from EUR 30,026 to EUR 60,128. The Net Asset Value of the Performance Fee Share Class increases to EUR 50.34m (i.e., EUR 50.17m as at previous Valuation Point + EUR 200,680 Share Class Return – EUR 30,102 increase to Performance Fee accrual). The Net Asset Value of the Performance Fee Share Class at the end of Day 3 therefore comprises:												
	<table border="0" style="width: 100%; border-collapse: collapse;"> <tr> <td style="width: 60%;">Investment on Day 1</td> <td style="width: 10%; text-align: right;">EUR</td> <td style="width: 30%; text-align: right;">50,000,000</td> </tr> <tr> <td>Add: Aggregate of Share Class Returns (Day 1 to Day 3)</td> <td style="text-align: right;">EUR</td> <td style="text-align: right;">400,810</td> </tr> <tr> <td>Less: Performance Fee accrual as at Day 3</td> <td style="text-align: right;">EUR</td> <td style="text-align: right;">-60,128</td> </tr> <tr> <td></td> <td style="text-align: right; border-top: 1px solid black;">EUR</td> <td style="text-align: right; border-top: 1px solid black;">50,340,682</td> </tr> </table>	Investment on Day 1	EUR	50,000,000	Add: Aggregate of Share Class Returns (Day 1 to Day 3)	EUR	400,810	Less: Performance Fee accrual as at Day 3	EUR	-60,128		EUR	50,340,682
Investment on Day 1	EUR	50,000,000											
Add: Aggregate of Share Class Returns (Day 1 to Day 3)	EUR	400,810											
Less: Performance Fee accrual as at Day 3	EUR	-60,128											
	EUR	50,340,682											
End of Performance Period	Assuming that the movement in the Share Class Return moves in line with the Benchmark Return for the remainder of the financial year, a Performance Fee of EUR 60,128 will be payable to the Management Company for the financial year and a new high watermark of EUR 1,006.81 (= 50,340,682 / 50,000) will be set for the next financial year.												

Example 4: Use of memorandum account for negative accrual / constant HWM

Assuming an investment of EUR 50m, i.e., Net Asset Value of the Share Class of EUR 50m and assuming a Participation Rate of 20%. The number of shares issued is assumed to be constant at 50,000 and the current high watermark is 1,000.

Day 1	As in Example 3 above, between the first Valuation Point of the Performance Period and the immediately preceding Valuation Point, the Benchmark Return is equal to +0.1%. In that same period the Share Class Return is +0.3%. The Differential Return is +0.2%. Therefore, an initial Performance Fee accrual of EUR 20,000 is included as a liability in the Net Asset Value calculation. The Net Asset Value of the Performance Fee Share Class increases to EUR 50.13m.
Day 2	On the following day, the Share Class Return is -0.2%, whilst the Benchmark Return is equal to +0.1%. The differential return is -0.3%, resulting in a decrease to the Performance Fee accrual of EUR 30,078 (i.e., EUR 50.13m x 0.3% x 20%). The Performance Fee accrual on Day 2, therefore, reduces from EUR 20,000 to nil. At the same time, a negative accrual of EUR -10,078 is recorded in the memorandum account. The Net Asset Value of the Performance Fee Share Class is EUR 50.05m (i.e., EUR 50.13m – EUR 100,260 Share Class Return + EUR 20,000 decrease in Performance Fee accrual).
Day 3	On Day 3, the Share Class Return is +0.1%, whilst the Benchmark Return is +0.05%. The differential return is +0.05%, resulting in an increase in the value of the memorandum accrual of EUR 5,005 (i.e., EUR 50.05m x 0.05% x 20%), from EUR -10,078 to EUR -5,073. No Performance Fee accrual is included in the Net Asset Value calculation as an amount of EUR -5,073 remains recorded on the memorandum account. The Net Asset Value of the Share Class increases to EUR 50.1m (i.e., EUR 50.05m + EUR 50,050 Share Class Return). The Net Asset Value of the Share Class at the end of Day 3 therefore comprises:

	Investment on Day 1	EUR	50,000,000
	Add: Aggregate of Share Class Returns (Day 1 to Day 3)	EUR	99,790
	Less: Performance Fee accrual as at Day 3	EUR	nil
		EUR	50,099,790
and the memorandum account recording the negative accrual at the end of Day 3 comprises:			
	Day 1 movement	EUR	nil
	Add: Day 2 movement	EUR	-10,078.00
	Less: Day 3 movement	EUR	5,005
		EUR	-5,073
End of Performance Period	Assuming that the Share Class Return moves in line with the Benchmark Return for the remainder of the financial year, the negative memorandum accrual of EUR -5,073 will remain in place and will be carried forward to the next financial year. No Performance Fee will be payable to the Management Company for the current financial year and no new high watermark will be set.		

For the subsequent financial year, on Day 1, assume the Share Class Return is +0.1% while the Benchmark Return is zero. The differential return is +0.1% and the Performance Fee accrual before considering the memorandum account is EUR 10,020 (i.e., EUR 50,099,790 * 0.1% * 20%). As the memorandum account shows the prior year's accrual of EUR -5,073, the effective Performance Fee accrual is EUR 4,947. Assuming that for the rest of that financial year, the share class return as well as the Benchmark Return is zero every day, a performance fee of EUR 4,947 will be payable to the Management Company and the Net Asset Value of the Share Class at the end of that financial year is 50,144,943 (= 50,099,790 + 50,080 – 4,947). A new high watermark of EUR 1,002.90 (= 50,144,943 / 50,000) will be set for the next financial year.

Following on from the examples provided above, the table below illustrates the operation of the accrual for the financial year from the perspective of an investor investing EUR 50,000 into the Sub-Fund.

Performance Period	Amount invested	Return on investment	Return on equivalent investment in the Benchmark	Differential Return	Movement in Performance Fee Accrual	Total Performance Fee Accrued	Memorandum Account
Example 1							
Day 1	50,000	150	50	100	20	20	0
Day 2	50,130	50	0	50	10	30	0
Day 3	50,170	201	251	-50	-10	20	0
End of period	50,381						
Example 2							
Day 1	50,000	150	50	100	20	20	0
Day 2	50,130	50	251	-201	-40	0	-20
Day 3	50,200	100	50	50	10	0	-10
End of period	50,301						
Example 3							
Day 1	50,000	150	50	100	20	20	0
Day 2	50,130	50	0	50	10	30	0
Day 3	50,170	201	50	151	30	60	0
End of period	50,341						
A new high watermark will be set							
Example 4							
Day 1	50,000	150	50	100	20	20	0
Day 2	50,130	-100	50	-150	-30	0	-10
Day 3	50,050	50	25	25	5	0	-5
End of period	50,100						
A new high watermark will not be set							

2.3 Additional Costs

All other additional costs are charged to the assets of the relevant Sub-Fund. These costs are separate to those named above and include, but are not limited to:

- costs for examination, asserting and enforcement of any claims for reduction, offsetting or refund of withholding taxes or other taxes or fiscal duties,
- costs for asserting and enforcing legal rights of the Company which appear to be justifiable and for defending any claims made against the Company which seem unjustified,
- all taxes, fees, public and similar charges which may be incurred in connection with administration and custody, or
- costs in connection with the purchase and sale of assets (including any research and analyst services made available in accordance with market practice, interest/fees for Deposits as well as fees resulting out of the provision and drawdown of credit facilities) and the use of securities lending programmes and securities lending brokers as well as interest cost; or
- compensation for the Management Company for arranging, preparing and executing securities lending and/or repurchase/reverse repurchase transactions without the use of securities lending programs and securities lending brokers of 30% of any income generated.

Costs for the use of securities lending programmes and securities lending brokers and compensation for the Management Company for arranging, preparing and executing securities lending and repurchase/reverse repurchase transactions can only be applied alternatively but in no case cumulatively for a respective transaction.

The Management Company may, in its absolute discretion, levy a lower compensation for arranging, preparing and executing securities lending and/or repurchase/reverse repurchase transactions than that mentioned above.

Certain Sub-Funds may incur additional costs as further described in Appendices 2 and 6.

2.4 Placement Fee

The Company may pay to the Management Company a placement fee ("Placement Fee") out of the assets of a Sub-Fund. The amount of the Placement Fee charged, if any, is listed in Appendix 2.

The Placement Fee is determined as a fixed amount per Share which shall in particular serve as a compensation for the distribution. The Placement Fees is paid in a single instalment on the first Valuation Day after the expiry of the subscription period ("Payment Date") and at the same time added to the Sub-Fund's assets as prepaid expenses. The Net Asset Value on the Payment Date is therefore not impacted by the Placement Fee. The Sub-Fund's position of pre-paid expenses is then amortized over a defined number of years ("Amortization Period") on a daily basis from the Payment Date. The remaining position of prepaid expenses per Share on each Valuation Day is calculated by linearly decreasing the fix amount per Share over the Amortization Period on a daily basis. After expiration of the Amortization Period the remaining position of prepaid expenses per Share is zero by definition.

2.5 Soft Commissions

Brokerage commissions on portfolio transactions for the Company may be paid by the Management Company and/or the Investment Managers, as consideration for research related services provided to them as well as for services rendered in the execution of orders. The receipt of investment research and information and related services allows the Management Company and/or the Investment Managers to supplement their own research and analysis and makes available to them the views and information of individuals and research staffs of other firms.

The Management Company and/or the Investment Managers may pay, or be responsible for the payment of, soft commissions only insofar as:

- (1) the Management Company and/or the Investment Managers and/or the Sub-Investment Managers (if any) and/or their connected persons act at all times in the best interest of the Company and Shareholders when entering into soft commission arrangements,

- (2) the goods and services relate directly to the activities of the Management Company and/or the Investment Managers and/or the Sub-Investment Managers (if any) and/or their connected persons and such activities are of demonstrable benefits to the Shareholders,
- (3) transaction execution is consistent with best execution standards and brokerage rates are not in excess of customary institutional full-service brokerage rates,
- (4) any such soft commissions are paid by the Management Company and/or the Investment Managers and/or the Sub-Investment Managers (if any) and/or their connected persons to broker-dealers which are corporate entities and not individuals, and
- (5) the availability of soft commission arrangements is not the sole or primary purpose to perform or arrange transaction with such broker or dealer.

Goods and services described above may include but are not limited to: research and advisory services, economic and political analysis, portfolio analysis, including valuation and performance measurement, market analysis, data and quotation services, computer hardware and software incidental to the above goods and services, clearing and custodian services and investment-related publications.

Such soft commissions do not include costs relating to travel, accommodation, entertainment, general administrative goods or services, general office equipment or premises, membership fees, employee salaries or direct money payment, which are to be paid by the Management Company and/or the Investment Managers.

Periodic disclosure in the form of a statement describing such soft commissions will be made in the Company's annual report.

2.6 Commission Sharing Arrangements

The Management Company and/or the Investment Managers may enter into commission sharing arrangements only where there is demonstrable benefit to the Company and where the Management Company and/or the Investment Managers are satisfied that the transactions generating the shared commissions are made in good faith, in strict compliance with applicable regulatory requirements and are in the best interests of the Company and the Shareholders.

Such arrangements must only be entered into by the Management Company and/or the Investment Managers on terms commensurate with best market practice and brokerage rates should not be in excess of customary institutional full-service brokerage rates. Such commissions may be used to pay for research and/or other goods and services. Other jurisdictions may have other arrangements in place to pay for such services in accordance with local regulatory obligations.

Periodic disclosure in the form of a statement describing such commission sharing arrangements will be made in the Company's annual report.

2.7 Third Party Fees and Expenses

If the investor is advised by third parties when acquiring shares or if such parties act as broker to the acquisition, they may quote costs or expense ratios that are not identical to the costs disclosed in this prospectus and in the key information document. The expense ratio may also exceed the total expense ratio as described in the prospectus. The reason for this may be specifically that the third party additionally takes into account the cost of its own operations (e.g., brokerage, advice or securities account maintenance). In addition, the third party may also take into account non-recurring costs, such as sales loads, and generally uses different calculation methods or estimates for the expenses incurred at Sub-Fund level, which include the Sub-Fund's transaction costs in particular. Divergences in the cost quotation may arise both in the case of information provided prior to conclusion of a contract and for regular cost information about the Sub-Fund investment held within a long-term client relationship.

2.8 Indemnity of Directors and Officers

The Company may indemnify any director or officer against any expenses reasonably incurred by him in connection with any legal action, suit or proceeding to which this person may be made a party by reason of his being, or having been, a director or officer of the Company, as described in further detail in the

Articles. This foregoing right of indemnity does not exclude other rights to which the person may be entitled.

2.9 Liabilities of the Sub-Funds

The Company (including the existing Sub-Funds and future Sub-Funds) shall be considered as one single legal entity. However, with regard to third parties, in particular towards the Company's creditors, each Sub-Fund is solely responsible for the liabilities attributable to it.

2.10 Ongoing Charges

The costs incurred by the Sub-Funds (or the respective Share Classes) during the preceding financial year (excluding transaction costs) are disclosed in the annual report and are also expressed as a ratio of the average volume of the Sub-Funds (or of the average volume of the respective Share Classes) ("Ongoing Charges"). In addition to the All-in-Fee as well as the *taxe d'abonnement* (see "Taxation" under Section XIII), all other costs are considered except for the incurred transaction costs, the costs the use of securities lending programmes and securities lending brokers and compensation for arranging, preparing, and executing securities lending and/or repurchase/reverse repurchase transactions by the Management Company and any performance fees.

If a Sub-Fund invests more than 20% of its assets in other UCITS or UCI that publish their ongoing charges, these ongoing charges are taken into consideration when calculating the Ongoing Charges for the Sub-Fund.

2.11 Restructuring Fee

In addition, the Management Company may charge a restructuring fee to certain Sub-Funds, provided that such fee is not charged directly to the Shareholder under the terms of a Share Class. The Management Company may reduce the restructuring fee at its absolute discretion.

2.12 Remuneration Policy

The primary components of monetary remuneration are the base salary, which typically reflects the scope, responsibilities and experience that are required in a particular role, and an annual discretionary variable compensation award. The variable compensation typically includes both, an annual bonus payment in cash after the end of each performance year and a deferred component for all employees whose variable remuneration exceeds a specified threshold.

The total amount of the variable remuneration payable throughout the Management Company depends on the performance of the business and on the Management Company's risk position. For this reason, it varies from year to year. In this respect the allocation of specific amounts to particular employees is based on the performance of the employee or his department during the period under review.

The level of pay awarded to employees is tied to both quantitative and qualitative performance indicators. Quantitative indicators are aligned around measurable goals. Qualitative indicators take into account actions reflecting the Management Company's core values of excellence, passion, integrity and respect. Such indicators also comprise the absence of significant regulatory breaches or deviations from compliance and risk standards including AllianzGI's sustainability risk management policy.

For investment professionals, whose decisions make a real difference to delivering successful outcomes for our clients, quantitative indicators are aligned around sustainable investment performance. In particular for portfolio managers, the quantitative element is aligned with the benchmarks of the client portfolios they manage or with the client's stated investment outcome objective measured over a multi-year framework.

For client facing professionals, goals include client satisfaction, measured independently.

The amounts ultimately distributed in the framework of the long-term incentive awards depend on the Management Company's business performance or the performance of certain funds over several years.

The remuneration of employees in controlling functions is not directly linked to the business performance of the departments monitored by the controlling function.

In accordance with the applicable rules, certain groups of employees are classified as "Identified Staff": members of the management, risk takers and employees in controlling positions, as well as all employees whose total remuneration puts them into the same remuneration category as members of the management and risk takers whose activities have a significant effect on the risk profiles of the Management Company and the funds managed by it.

Employees classified as Identified Staff are subject to additional standards relating to performance management, the form of variable compensation and the timing of payments.

Multi-year targets and deferred parts of the variable compensation ensure a long-term performance measuring. In particular, the performance of portfolio managers is measured to a large extent against quantitative return results over a multi-year framework.

For Identified Staff a significant portion of the annual variable remuneration is deferred for three years, starting from a defined variable compensation level. 50% of the variable compensation (deferred and non-deferred) has to consist of units or shares of funds managed by the Management Company or comparable instruments.

An ex-post risk adjustment enables explicit adjustments to previous years' performance evaluation and related compensation, to prevent the vesting of all or part of the amount of a deferred remuneration award (Malus), or the return of ownership of an amount of remuneration to the Management Company (Clawback)

AllianzGI has a comprehensive risk reporting in place, which covers both current and future risks of the Management Company's business activities. Risks which significantly exceed the organisation's risk appetite are presented to the Management Company's Global Remuneration Committee which will decide, if necessary, on adjustments to the total remuneration pool.

Further details of the Management Company's current remuneration policy are published on the Internet at <https://regulatory.allianzgi.com>. This includes a description of the calculation methods for remuneration and benefits awarded to certain groups of employees, as well as details of the persons responsible for allocation, including members of the remuneration committee. On request, the information will be made available by the Management Company in hard copy without charge.

2.13 Investments in Target Funds

To the extent that a Sub-Fund invests in units of target funds, investors will have to bear not only directly the expenses and costs described in this prospectus, but also indirectly the pro rata expenses and costs charged to the target fund. The expenses and costs charged to the target fund are determined by their constitutional documents (e.g., management regulations or articles of incorporation) and are therefore impossible to forecast in an abstract way. Typically, however, it is to be expected that the fees and expenses charged to the Company described in this prospectus are charged to target funds as well.

If a Sub-Fund acquires shares of a UCITS or UCI which is directly or indirectly managed by the same company or by another company with which the Company is linked by common management or control, or by a substantial direct or indirect participation according to the Law (including cross Sub-Fund investments between Sub-funds) then neither the Company nor the associated company may charge fees for the subscription or redemption of units.

If a Sub-Fund invests a substantial portion of its assets in other UCITS and/or other UCI as defined above, a management fee at the level of such UCITS or UCI (excluding any performance fee, if any) of no more than 2.50% per annum of their net asset value may be charged.

The Company indicates in its annual report the maximum proportion of management fees charged both to the Sub-Funds itself and to the UCITS and/or other UCI in which it invests.

XIII. Taxation

1. General

The following statements on taxation below are intended to be a general summary of certain tax consequences that may result to the Company and Shareholders in connection with their investment in the Company and are included herein solely for information purposes. They are based on the law and practice in force at the date of this Prospectus. There is no assurance that the tax status of the Company or Shareholders will not be changed as a result of amendments to, or changes in the interpretation of, relevant tax legislation and regulations. This summary is of a general nature only and is not intended to be, nor should it be construed to be, legal or tax advice to any particular investor. Prospective investors should therefore consult their own professional advisers as to the effects of state, local or foreign laws, including Luxembourg tax law, to which they may be subject.

Shareholders may be resident for tax purposes in many different countries. Dividends, interest payments and other income paid to the Company on its investments may be subject to non-refundable withholding taxes or other taxes in the country of origin. No attempt is made in this Prospectus to summarize the taxation consequences for each investor. These consequences will vary depending on the Shareholder's personal circumstances in accordance with the law and practice currently in force in a Shareholder's country of citizenship, residence, domicile, permanent residence or in which a Shareholder has his shares in custody.

2. Luxembourg

2.1 Taxation of the Company

The Company is not subject to any Luxembourg tax on profits or income, nor are any distributions from the Sub-Funds subject to any Luxembourg withholding tax.

The Company is liable in Luxembourg for an annual subscription tax ("taxe d'abonnement") which is payable quarterly on the basis of the value of the net assets of the Company at the end of the relevant calendar quarter.

The rate of the subscription tax is 0.05% per annum of the Net Asset Value of each Share Class which is available to all investors.

The rate of the subscription tax is 0.01% per annum of the Net Asset Value for:

- Sub-Funds whose sole object is the collective investment in money market instruments and the placing of Deposits with credit institutions,
- Sub-Funds whose sole object is the collective investment in Deposits with credit institutions and
- Sub-Funds or Share Classes which are reserved to one or more Institutional Investors.

A Sub-Fund that satisfies the following conditions is exempt from the annual subscription tax:

- the securities issued by the Sub-Fund are reserved to Institutional Investors, and
- the sole object of the Sub-Fund is the collective investment in money market instruments and the placing of Deposits with credit institutions, and
- the weighted residual portfolio maturity of the Sub-Fund does not exceed 90 days, and
- the Sub-Fund has obtained the highest possible rating from a recognized rating agency.

There is no Luxembourg stamp duty or other tax payable on the issuance of the Shares. Capital gains realised on Company assets are not subject to tax in Luxembourg.

2.2 Taxation of Shareholders

In accordance with the current laws of Luxembourg, Shareholders are neither subject to (1) income tax on income from investment funds, (2) capital gains tax nor (3) withholding tax, subject to the provisions of the following paragraph. However, this does not apply to Shareholders who have their domicile, residence or a permanent establishment in Luxembourg.

The OECD Common Reporting Standard

Luxembourg has implemented the “Standard for Automatic Exchange of Financial Account Information”, also known as the Common Reporting Standard (“CRS”), into Luxembourgish law on 18 December 2015.

The CRS is a new, single global standard on Automatic Exchange of Information (“AEOI”) which was approved by the Council of the Organisation for Economic Cooperation and Development (“OECD”) in July 2014. It draws on earlier work of the OECD and the EU, global anti-money laundering standards and, in particular, the Model FATCA Intergovernmental Agreement. The CRS sets out details of the financial information to be exchanged, the financial institutions required to report, together with common due diligence standards to be followed by financial institutions. Under the CRS, participating jurisdictions will be required to exchange certain information held by financial institutions regarding customers with tax residency outside the country. Over 90 jurisdictions have committed to exchanging information under the CRS. On 29 October 2014, Luxembourg (along with 50 other countries) signed such multilateral agreement (Multilateral Competent Authority Agreement on automatic exchange of financial account information “MCAA”) and committed, along with more than 40 other countries, to an early implementation of the CRS. The countries participating in the automatic exchange of financial accounts are those countries that have signed the MCAA. For the early adopters, the first exchange of information took place as of the end of September 2017 with respect to accounts that existed as of 1 January 2016 and high value accounts that existed as of 31 December 2015. Initial information on low-value individual accounts that existed as of 31 December 2015, and legal entity accounts was exchanged at the end of September 2017 or the end of September 2018, depending on when the financial institutions identify them as reportable.

Investors should note that the Company principally will be required to disclose the name, address, jurisdiction(s) of tax residence, date and place of birth, account reference number, tax identification number(s) of each person who is considered to be an account holder for CRS and information relating to each investor’s investment (including but not limited to the value of and any payments in respect of the investments) to the Luxembourg tax authorities who may in turn exchange this information with the foreign tax authorities in territories who are participating jurisdictions for the purposes of the CRS. In order to comply with its obligations, the Company may require additional information from Investors.

Investors refusing to provide the requisite information to the Company may also be reported to the Luxembourg tax authorities.

The Company will comply with the reporting and due diligence obligations for information on financial accounts and will provide annually the Luxembourg tax authorities with the required information, which will forward this information to the tax authorities of the countries in which the individual and/or legal entity concerned is resident.

Each prospective Investor should consult its own professional advisers on the requirements applicable to it under these arrangements.

Shareholders are advised to inform themselves about the tax consequences of subscription, purchase, holding, redemption or any other disposal of Shares or earning income (e.g., through distributions of a Sub-Fund or any accumulation) in the framework of the laws in a Shareholder’s country of citizenship, residence, domicile or in which a Shareholder has his Shares in custody and, if necessary, to seek professional advice.

3. US Tax Withholding and Reporting under FATCA

The Foreign Account Tax Compliance provisions of the Hiring Incentives to Restore Employment Act (“FATCA”) generally impose a U.S. federal reporting and withholding tax regime with respect to certain U.S. source income earned and gross proceeds from the sale or other disposal of property that can produce such U.S. source income. The rules are designed to require a direct and indirect ownership of certain non-US accounts and non-US entities by certain U.S. persons (e.g., U.S. citizens and U.S. residents or a partnership, corporation or trust organized in the United States or under the laws of the United States or any of its States) to be reported to the U.S. Internal Revenue Service. Pursuant to FATCA, payments of fixed or determinable annual or periodic gains, profits and income, including dividends, interest and gains, from sources within the United States, made after 30 June 2014, payments attributable to gross proceeds from the sale or other disposition of property that could produce U.S. source interest or dividends made after 31 December 2016, and certain payments (or a portion thereof) by a foreign

financial institution made after 31 December 2016, to a foreign financial institution or other foreign entity or “passthru payments” on the individual shareholder (to the extent provided in future regulations which will be subject to further changes, but in no event before 1 January 2017) will be subject to a withholding tax of 30% unless various reporting requirements are satisfied.

Luxembourg has entered into an intergovernmental agreement with the United States of America (“IGA”). Under the IGA, FATCA compliance will be enforced under new local Luxembourg tax legislation (as transposed into Luxembourg law by the law of 24 July 2015) and reporting rules and practices.

The Company, Nominee and/or Transfer Agent will likely require additional information from Shareholders in order to comply with these provisions. The Company, Nominee and/or Transfer Agent may disclose the information, certifications or other documentation that they receive from (or concerning) their investors to the U.S. Internal Revenue Service, non-US taxing authorities, or other parties as necessary to comply with FATCA, related intergovernmental agreements or other applicable law or regulation. Each prospective investor is urged to consult his tax adviser regarding the applicability of FATCA to himself and the Company (and/or the Sub-Funds) and any other reporting requirements with respect to the prospective investor’s own situation. If a change in circumstances occurs, the shareholder or intermediary must inform the Company within 30 days.

4. PRC Taxation

Corporate Income Tax

If the Company or the relevant Sub-Fund is considered a tax resident enterprise of the PRC, it will be subject to PRC corporate income tax (“CIT”) at 25% on its worldwide taxable income. If the Company or the relevant Sub-Fund is considered a non-tax resident enterprise with an establishment or place or establishment of business in the PRC, the profits attributable to that PE would be subject to CIT at 25%.

Under the PRC CIT Law effective from 1 January 2008 and its implementation rules, a non-PRC tax resident enterprise without an establishment in the PRC will generally be subject to withholding income tax (“WIT”) of 10% on its PRC sourced income, including but not limited to passive income (e.g., dividends, interest, gains arising from transfer of assets, etc.).

The Management Company, in respect of the Company or the Investment Manager, in respect of the relevant Sub-Fund(s), intend to manage and operate the Company or the relevant Sub-Fund(s) in such a manner that the Company or the relevant Sub-Fund(s) should not be treated as a tax resident enterprise of the PRC or a non-PRC tax resident enterprise with an establishment in the PRC for CIT purposes, although due to uncertainty in tax laws and practices in the PRC, this result cannot be guaranteed.

(i) Interest

Unless a specific exemption is applicable, non-PRC tax resident enterprises are subject to PRC WIT on the payment of interests on debt instruments issued by PRC tax resident enterprises, including bonds issued by enterprises established within the PRC. The general WIT rate applicable is 10%, subject to reduction under an applicable double tax treaty and agreement by the PRC tax authorities.

Interest derived from government bonds issued by the in-charge Finance Bureau of the State Council and/or local government bonds approved by the State Council is exempt from PRC CIT under the PRC CIT Law.

According to a tax circular jointly issued by the Ministry of Finance of the PRC (“MoF”) and the State Administration of Taxation of the PRC (“STA”) on 7 November 2018, i.e., Circular on the Enterprise Income Tax and Value-Added Tax Policies for Foreign Institutions investing in Onshore Bond Markets (“Circular 108”), the foreign institutional investors are temporarily exempt from PRC CIT with respect to bond interest income derived in the PRC bond market for the period from 7 November 2018 to 6 November 2021. The scope of such PRC CIT exemption has excluded bond interest gained by foreign investors’ onshore entities/establishment that are directly connected with such onshore entities/establishment. According to the tax circular published jointly by the MoF and the STA on 22 November 2021 (“Circular 34”), such temporary tax exemption is extended until 31 December 2025. However, there is no guarantee that such temporary tax exemption will continue to apply, will not be repealed and re-imposed retrospective, or that no new tax regulations and practice in China specifically relating to the PRC bond market will not be promulgated in the future.

(ii) Dividend

Under the current PRC CIT Law and its implementation rules, non-PRC tax resident enterprises are subject to PRC WIT on cash dividends and bonus distributions from PRC tax resident enterprises. The general WIT rate applicable is 10%, subject to reduction under an applicable double tax treaty and agreement by the PRC tax authorities.

(iii) Capital gain

Based on the CIT Law and its Implementation Rules, "income from the transfer of property" sourced from the PRC by non-PRC tax resident enterprises should be subject to 10% PRC WIT unless exempt or reduced under an applicable tax treaty and agreement by the PRC tax authorities.

The MoF, STA and the China Securities Regulatory Commission ("CSRC") issued joint circulars to clarify the taxation of the Stock Connect, in which capital gain realised from the transfer of China A-Shares is temporarily exempt from PRC WIT. The MoF, STA and CSRC issued Circular Caishui [2014] No. 79 ("Circular 79") dated 31 October 2014 to clarify the taxation of capital gains on transfer of PRC equity investment assets derived by QFIs and RQFIs. Pursuant to Circular 79, for QFIs and RQFIs without a PE in the PRC or with a PE in the PRC but the income so derived in the PRC is not effectively connected with such establishment, capital gain derived from the transfer of PRC equity investment assets such as China A-Shares on or after 17 November 2014 is temporarily exempt from PRC WIT. However, capital gain realised by QFIs and RQFIs prior to 17 November 2014 is subject to PRC WIT in accordance with the provisions of the laws. The MoF, the STA and the CSRC issued joint circulars Caishui [2014] No. 81 and Caishui [2016] No. 127 to clarify the taxation of the Stock Connect, in which capital gain realized from the transfer of China A-Shares via Stock Connect is temporarily exempt from PRC WIT.

Based on verbal comments from the PRC tax authorities, gains realized by foreign investors (including FIs) from investment in PRC debt securities via Bond Connect are non-PRC sourced income and thus should not be subject to PRC WIT. However, there are no written tax regulations issued by the PRC tax authorities to confirm that interpretation. As a matter of practice, the PRC tax authorities have not levied PRC WIT on capital gains realised by FIs from the transfer of debt securities, including those traded via CIBM.

In light of the above and based on professional and independent tax advice, the Management Company and/or the relevant Investment Manager (as the case may be) intends to:

- provide for WIT at 10% on dividend from China A-Shares and interest received from debt instruments issued by PRC enterprises if such WIT is not withheld at source; and
- not make provisions for any PRC WIT in respect of gross realised and unrealised capital gains derived from the trading of China A-Shares and non-equity investments such as PRC debt instruments.

Given the possibility of the tax rules being changed or differently interpreted and the possibility of taxes being applied retrospectively, any provision for taxation made by the Investment Manager in a given point in time may be excessive or inadequate to meet the PRC tax liabilities in connection with investments made by the Company or the relevant Sub-Fund in the PRC. Consequently, investors may be advantaged or disadvantaged depending on how any such gains or income will in fact be calculated or taxed, how the Investment Manager provides for the tax and when investors subscribed and/or redeemed their holdings in/from the Company or the relevant Sub-Fund. If there is a change in the tax requirement or environment which results in an under-provision by the Investment Manager of actual or potential tax liabilities, the then existing investors and new investors will be disadvantaged as the Company, or the relevant Sub-Fund will have to pay the difference between the Company or the relevant Sub-Fund's then WIT provision and the taxation liabilities under the new regime. On the contrary, if there is a change in the tax requirement or environment which results in an over-provision by the Investment Manager, the investors who have already redeemed the Shares under the old regime will be disadvantaged as they would have contributed to the over-provision. In this case the then existing investors and the new investors will benefit as the difference between the Company or the relevant Sub-Fund's then WIT provision and the taxation liabilities will be returned to the Company or the relevant Sub-Fund as assets thereof.

In light of the above-mentioned uncertainty and in order to meet the potential tax liability for gains on disposal of debt securities and interest income derived from debt instruments, the Company reserves the right to vary the provision for WIT on such gains or interest income for the account of the Company or the

relevant Sub-Fund in respect of any potential tax on the gross realized and unrealized capital gains and interest income.

Upon any future resolution of the above-mentioned uncertainty or further changes to the tax law or policies, the Company will, as soon as practicable, make relevant adjustments to the amount of tax provision (if any) as they consider necessary. The amount of any such tax provision will be disclosed in the accounts of the Company.

It should also be noted that the actual applicable tax imposed by the PRC tax authorities may be different and may change from time to time. There is a possibility of the rules being changed and taxes being applied retrospectively. As such, any provision for taxation made by the Investment Manager for the account of the relevant Sub-Fund may be excessive or inadequate to meet final PRC tax liabilities. Consequently, Shareholders of the Sub-Fund may be advantaged or disadvantaged depending upon the final tax liabilities, the level of provision and when they subscribed and/or redeemed their Shares in/from the Sub-Fund.

Value-added Tax ("VAT") and other surcharges (applicable on and after 1 May 2016)

According to the Circular Caishui [2016] 36 ("Circular 36"), VAT at 6% shall be levied on the difference between the selling and buying prices of those marketable securities starting from 1 May 2016.

The gains derived from trading of marketable securities (including A-shares and other PRC listed securities) are exempted from VAT in the PRC under Circular 36 and Caishui [2016] No.70. In addition, deposit interest income and interest received from government bonds and local government bonds are also exempt from VAT.

According to Circular 108 and Circular 34, the foreign institutional investors are temporarily exempt from VAT with respect to bond interest income derived in the PRC bond market for the period from 7 November 2018 to 31 December 2025. However, there is no guarantee that such temporary tax exemption will continue to apply, will not be repealed and re-imposed retrospective, or that no new tax regulations and practice in China specifically relating to the PRC bond market will not be promulgated in the future.

Dividend income or profit distributions on equity investment derived from PRC are not included in the taxable scope of VAT.

In addition, urban maintenance and construction tax (currently at the rate ranging from 1% to 7%), educational surcharge (currently at the rate of 3%) and local educational surcharge (currently at the rate of 2%) are imposed based on the VAT liabilities.

Stamp Duty

Stamp duty under the PRC laws generally applies to the execution and receipt of all taxable documents listed in the PRC's Provisional Rules on Stamp duty. Stamp Duty is generally imposed on the sale of PRC-listed shares at a rate of 0.1% of the sales consideration. The Company or the relevant Sub-Fund will be subject to this tax on each disposal of PRC listed shares. No stamp duty is expected to be imposed on non-PRC tax resident holders of government and corporate bonds, either upon issuance or upon a subsequent transfer of such bonds.

Non-PRC tax resident Shareholders will not be subject to PRC tax on distributions received from the Company or the relevant Sub-Fund, or on gains derived from the disposal of Shares. PRC tax resident Shareholders should seek their own tax advice on their tax position with regard to their investment in the Company or the relevant Sub-Fund.

There can be no guarantee that no new tax laws, regulations and practice in the PRC specifically relating to the FII, Stock Connect, Bond Connect or CIBM regime (as the case may be) may be promulgated in the future and may be applied retrospectively. The promulgation of such new laws, regulations and practice may operate to the advantage or disadvantage of the Shareholders due to the Company or the relevant Sub-Fund's investments in the PRC market.

Investors should inform themselves of, and where appropriate consult their professional advisors on, the possible tax consequences of subscribing for, buying, holding, converting, redeeming, or otherwise disposing of Shares under the laws of their country of citizenship, residence, or domicile or incorporation.

XIV. Conflicts of Interest and Transactions with Connected Parties

1. Conflicts of Interest

The Company, the Management Company, the Depositary, the Registrar and Transfer Agent and any of the Investment Managers, Investment Advisors, Paying and Information Agent or Distributors may each from time-to-time act in such capacity in relation to, or be otherwise involved in, other funds which have similar investment objectives to those of the Sub-Funds. It is, therefore, possible that any of them may, in the course of business, have potential conflicts of interests with one or more of the Sub-Funds.

Each party will, at all times, have regard in such event to its obligations under its respective service agreement with the Company and will endeavour to ensure that such conflicts of interest are resolved fairly. The Management Company has adopted a policy designed to ensure that in all transactions a reasonable effort is made to avoid conflicts of interest and, when they cannot be avoided, such conflicts are managed such that the Sub-Funds and their Shareholders are fairly treated.

In addition, any of the foregoing parties may deal, as principal or agent, with any of the Sub-Funds, provided that such dealings are carried out as if effected on normal commercial terms negotiated on an arm's length basis and in the best interests of Shareholders.

Dealings will be deemed to have been effected on normal commercial terms if: (i) a certified valuation of a transaction by a person approved by the Depositary as independent and competent is obtained; (ii) the transaction is executed on best terms on an organised investment exchange in accordance with the rules of such exchange; or (iii), where (i) and (ii) are not practical, the transaction is executed on terms which the Depositary is satisfied are normal commercial terms negotiated at arm's length.

Conflicts of interest may arise as a result of transactions in derivatives, OTC derivatives and efficient portfolio management techniques and instruments. For example, the counterparties to, or agents, intermediaries or other entities which provide services in respect of, such transactions may be related to the Management Company, any Investment Manager or Investment Advisor or the Depositary. As a result, those entities may generate profits, fees or other income or avoid losses through such transactions. Furthermore, conflicts of interests may also arise where the collateral provided by such entities is subject to a valuation or haircut applied by a related party.

The Management Company has adopted a policy designed to ensure that its service providers act in the Sub-Funds' best interests when executing decisions to deal and placing orders to deal on behalf of those Sub-Funds in the context of managing the Sub-Funds' portfolios. For these purposes, all reasonable steps must be taken to obtain the best possible result for the Sub-Funds, taking into account price, costs, speed, likelihood of execution, order size and nature, research services provided by the broker to the Investment Manager or Investment Advisor, or any other consideration relevant to the execution of the order. Information about the Management Company's execution policy and any material change to the policy are available to Shareholders at no charge upon request.

2. Transactions with Connected Parties

If arrangements for borrowing or making Deposits by any of the Sub-Funds are made with any of the Depositary, Management Company or Investment Managers or any of their connected persons, such person shall be entitled to retain for its own use and benefit any profits which may be derived from such an arrangement. However, the terms for such transactions must be negotiated at arm's length in accordance with ordinary normal course of business and the arrangement shall be in the best interests of the Shareholders. In addition:

- the interest charges on borrowing arrangements with such persons and the fees (if any) for arranging or terminating the arrangement shall be at a rate not higher than is in accordance with normal banking practice, the commercial rate for borrowing arrangements of that similar type, size and nature; and
- the interest received on Deposits placed with such persons shall be at a rate not lower than is in accordance with normal banking practice, the commercial rate for a deposit of that similar type, size and term.

Subject to the prior written consent of the Depositary, the Management Company, any Investment Manager, the Directors or any of their connected persons may deal as principal with any Sub-Fund and shall not be liable to account either to each other or to the relevant Sub-Fund or any of its Shareholders for any profits or benefits made or derived from such transactions provided always that such transactions are transacted and executed at arm's length and in the best interest of the Shareholders. If such transactions are entered into, they shall be disclosed in the annual report of the Company.

Connected brokers may not, in aggregate, account for more than 50% of any Sub-Fund's transactions in value in any financial year.

XV. Risk Factors

Investment in a Sub-Fund may be associated with the following risk factors in particular:

1. General Risk Factors applicable to All Sub-Funds unless otherwise stated

ABS and MBS Risk

The income, performance and/or capital repayment amounts of ABS and MBS are linked to the income, performance, liquidity and credit rating of the underlying or covering pool of reference assets (e.g., receivables, securities and/or credit derivatives), as well as the individual assets included in the pool or their issuers. If the performance of the assets in the pool is unfavourable for investors, depending on the form of the ABS or MBS, those investors may suffer losses up to and including total loss of invested capital.

ABS and MBS may be issued with or without the use of a special-purpose vehicle ("SPV"). Such SPVs normally do not engage in any other business aside from issuing ABS or MBS. The pool underlying the ABS or MBS, which also often consists of non-fungible assets, normally represents the only assets of the SPV or the only assets from which the ABS and MBS are to be serviced. If ABS or MBS are issued without the use of a SPV, there is the risk that the liability of the issuer will be limited to the assets included in the pool. The principal risks in respect of the assets included in the pool are concentration risk, liquidity risk, interest-rate risk, creditworthiness risk, company-specific risk, general market risk, risk of default and counterparty risk as well as the general risks of investing in bonds and derivatives, in particular interest-rate risk, creditworthiness risk, company-specific risk, general market risk, risk of default, counterparty risk and liquidity risk.

As a result, ABS and MBS may be highly illiquid and prone to substantial price volatility. These instruments may therefore be subject to greater credit, liquidity and interest-rate risks compared to other debt securities. They are often exposed to extension and prepayment risks and risks that the payment obligations relating to the underlying assets are not met, which may adversely impact the returns of the securities, the Net Asset Value of the relevant Sub-Fund or investors.

Active Currency Positions Risk

A Sub-Fund may implement active currency derivative positions that may not be correlated with the underlying securities positions held by the Sub-Fund. Therefore, such Sub-Fund may suffer a significant or total loss even if there is no loss of the value of the underlying securities positions (eg., equities, debt securities) held by the Sub-Fund.

Asset Allocation Risk

The performance of the Sub-Fund is partially dependent on the success of the asset allocation strategy employed by that Sub-Fund. There is no assurance that the strategy employed by the Sub-Fund will be successful and therefore the investment objective of the Sub-Fund may not be achieved. The investments of the Sub-Fund may be periodically rebalanced and therefore that Sub-Fund may incur greater transaction costs than a Sub-Fund with static allocation strategy.

Capital Risk

There is a risk that capital of a Sub-Fund or the capital that can be allocated to a Class will decrease. Excessive redemptions of a Sub-Fund's Shares or distributions exceeding realised capital gains and other income of returns on investments could have the same effect. Distribution Share applying the Fixed Percentage Policy have a relatively high risk of distributions exceeding realised capital gains and other income. A reduction in the capital of a Sub-Fund or the capital that can be allocated to a Class could make the management of the Company, a Sub-Fund or a Class unprofitable, which could lead to the liquidation of the Company, a Sub-Fund or a Class and to investor losses.

Certificate Investments Risk

A certificate vests the right, subject to the terms and conditions of the certificate, for the certificate holder to demand payment of a specific amount of money or delivery of certain assets on the settlement date. Whether the certificate holder has a corresponding claim on performance and, if so, to what extent, depends on certain criteria, such as the performance of the underlying asset during the term of the certificate or its price on certain days. As an investment vehicle, certificates are subject to the following risks in relation to the issuer of the certificate: creditworthiness risk, company-specific risk, settlement default risk and counterparty risk. Other risks that should be emphasised are general market risk, liquidity risk and, if applicable, currency risk. Certificates are not hedged through other assets or through third-party guarantees. This applies likewise to any permissible position held through another instrument based on the law of obligations.

Changes in Underlying Conditions Risk

Over time, the underlying conditions (e.g., economic, legal or tax) within which an investment is made may change. This could have a negative effect on the investment and on the treatment of the investment by the investor.

Changes to the Company and/or a Sub-Fund Risk

The Articles, investment policy and other basic aspects of a Sub-Fund may be changed whenever permitted. In particular, a change to the investment policy within the permitted range may change the risk profile associated with such Sub-Fund. Such changes may have a negative impact on the performance of the Sub-Fund.

Closed-End Fund Risk

When investing in closed-end funds, the income, performance and/or capital repayment will depend on the income, performance and credit rating of the underlying investments of the closed-end funds. If the performance of the assets of the closed-end-funds are unfavourable for its investors, depending on the form of the closed-end-funds, investors of the relevant Sub-Fund can suffer partial, or even total loss.

Redemptions of investments in closed-end funds may not be possible. Since such funds commonly have a fixed term which makes continuous liquidation/termination of such investments in closed-end funds prior to maturity impossible. In the case of a closed-end fund which maturity is not already determined, the liquidity risk may be even higher. Eventually, investments in closed-end funds might be sold on a secondary market, if any, with the risk of significant bid/offer spreads. Investments in closed-end funds may also be fully or partially repaid prior to maturity, which could lead to a less attractive total investment in the respective closed-end fund as well as to a less attractive reinvestment. In addition, the corporate governance mechanisms, the transferability as well as the possibility to rate, to receive adequate information about and to evaluate investments in closed-end-funds may deteriorate before maturity.

The principal risks for investments in closed-end funds are general market risk, concentration risk, liquidity risk, the risk of interest rate changes, creditworthiness risk, company-specific risk, settlement default risk and counterparty risk. Specific risks vary depending on the particular type of closed-end fund.

When investing in closed-end funds, costs are regularly incurred both at the level of the funds themselves particularly in respect of service provider fees, as well as at the level of the portfolio making the investment. These may result in increased charges to the investors in the portfolio making the investment in the closed-end fund.

Company-Specific Risk

The value of a Sub-Fund's assets (in particular of securities and money-market instruments directly or indirectly held by such Sub-Fund) may be affected by company-specific factors (e.g., the issuer's business situation). If a company-specific factor deteriorates, the price of the respective asset may drop significantly and for an extended period of time, possibly without regard to an otherwise generally positive market trend. This may have an adverse impact on the Sub-Fund and/or the investor.

Concentration Risk

If a Sub-Fund focuses its investments on certain markets, types of investments, particular countries, regions, or industries, this may reduce risk diversifications. Consequently, such Sub-Fund may be particularly dependent on the development of these investments, markets or related markets, individual or interdependent countries or regions, industries or industries that influence each other or companies of such markets, countries, regions or industries. As such, the Sub-Fund is likely to be more volatile than a fund that has a more diversified investment strategy. It may be more susceptible to fluctuations in value resulting from a limited number of holdings or the impact of adverse conditions on a particular investment or market. This may have an adverse impact on the performance of the Sub-Fund and consequently adversely affect an investor's investment in the Sub-Fund.

Contingent Convertible Bonds Investment Risk

Investing in contingent convertible bonds ("CoCos") is associated with the following specific risks as issued in the statement ESMA/2014/944 ("Potential Risks Associated with Investing in Contingent Convertible Instruments") issued by the ESMA which include, but are not limited to (i) Trigger level risk: trigger levels differ; they determine exposure to conversion risk depending on the distance between the price of the equity security and the trigger level; (ii) Coupon cancellation risk: coupon payments may be cancelled by the issuer at any point and for any length of time; (iii) Capital structure inversion risk: contrary to classic capital hierarchy, CoCo investors may suffer a loss of capital when equity shareholders do not; (iv) Call extension risk: CoCos are issued as perpetual instruments, callable at predetermined levels only with the approval of the competent authority; (v) Unknown risk: the structure of the instruments is innovative yet untested; (vi) Yield/valuation risk: investors are drawn to CoCos as a result of their frequently attractive yield, which may, however, also represent a premium to their price in light of the complexity of how they are structured.

Convertible Bonds Investments Risk

Investing in convertible bonds are normally associated with increased creditworthiness risk, risk of default, risk of interest rate changes, prepayment risk, general market risk, and liquidity risk (for example, the asset cannot be sold or can only be sold at a significant discount to the purchase price), all of which may adversely impact the Net Asset Value of the relevant Sub-Fund.

The value of convertible bonds may be affected by the price movement of the underlying securities (i.e., equities), among other things. Convertible bonds may also have call provisions and other features which may give rise to the risk of a call. All these factors may adversely impact the Net Asset Value of the relevant Sub-Fund.

Counterparty Risk

Transactions not handled through a stock exchange or a Regulated Market (e.g., OTC trades) are exposed to the risk that a counterparty may default or not completely fulfil its obligations in addition to the general risk of settlement default. This is particularly true of OTC financial derivative instruments and other transactions based on techniques and instruments. Default by a counterparty may result in losses for a Sub-Fund. However, such risk can be significantly reduced, especially with respect to OTC derivative transactions, by receipt of collateral from the counterparty in accordance with the Company's collateral management policy as described in Appendix 1.

Country and Region Risk

If a Sub-Fund focuses its investments on particular countries or regions, this may increase the concentration risk. Consequently, such Sub-Fund is particularly susceptible to the adverse development and risks of individual or interdependent countries and regions, or of companies based and/or operating in those countries or regions. Any adverse economic, political, policy, foreign exchange, liquidity, tax, legal or regulatory event or development in such countries, regions or companies may adversely impact the performance of the Sub-fund and/or the value of Shares held by investors. Economic or political instability in certain countries in which a Sub-Fund is invested may lead to a situation in which such Sub-Fund does not receive part, or all of the monies owed to it in spite of the solvency of the issuer of the relevant assets. Currency or transfer restrictions or other legal changes may have a significant effect. In addition, Sub-Funds which focus on certain countries or regions, have a limited investment universe which results in limited risk diversification compared to broadly investing funds. The smaller the respective country or region is the more limited the investment universe and the more limited the risk diversification of the respective Sub-Fund might be. A limited risk diversification can increase the impact of the development of individual securities acquired for the respective Sub-Fund.

Credit Rating Risk

Credit ratings of Investment Grade debt securities assigned by rating agencies (e.g., Fitch, Moody's and/or Standard & Poor's) are subject to limitations and do not guarantee the creditworthiness of the security and/or issuer at all times.

Creditworthiness and Downgrading Risk

The creditworthiness (ability to pay) of the issuer of an asset (in particular, of a security or money-market instrument directly or indirectly held by the Sub-Fund) may fall. This usually leads to a decrease in the price of the asset greater than that caused by general market fluctuations. Further, there is a risk that the credit rating of certain debt securities, or the issuers of debt securities, may be downgraded due to adverse market conditions. The Sub-Fund may or may not be able to dispose of the Debt Securities that are being downgraded. This may lead to a fall in the NAV of the Sub-Fund and the performance of the Sub-Fund will be adversely affected.

Currency Risk

If a Sub-Fund directly or indirectly (via derivatives) holds assets denominated in currencies other than its Base Currency or if a class of shares of the Sub-Fund is designated in a currency other than the Base Currency of the Sub-Fund (each a "foreign currency"), it is exposed to a currency risk that if foreign currency positions have not been hedged or if there is any change in the relevant exchange control regulations, the NAV of the Sub-Fund or that class of shares may be affected unfavorably. Any devaluation of the foreign currency against the Base Currency of the Sub-Fund would cause the value of the assets denominated in the foreign currency to fall, and as a result may have an adverse impact on the Sub-Fund and/or the investors.

Custodial Risk

Sub-custodians may be appointed in local markets for purpose of safekeeping assets in those markets. Where a Sub-Fund invests in markets where custodial and/or settlement systems are not fully developed, the assets of such Sub-Fund may be exposed to custodial risk. A Sub-Fund may be denied access, in whole or in part, to investments held in custody in the event of bankruptcy, negligence, wilful misconduct or fraudulent activity on the part of the Depositary or sub-custodian. In such circumstances, a Sub-Fund may take a longer time or may even be unable to recover some of its assets (in extreme circumstances such as the retroactive application of legislation and fraud or improper registration of title), which may lead to significant losses for the Sub-Fund and consequently adversely affect an investor's investment in the Sub-Fund. The Custodial Risk may apply to assets as well as to collateral.

Dilution and Swing Pricing Risk

The actual cost of purchasing or selling the underlying assets of a Sub-Fund may be different from the booking value of these assets in the Sub-Fund's valuation. The difference may arise due to dealing and other costs (such as taxes) and/or any spread between the buying and selling prices of the underlying assets. These dilution costs can have an adverse effect on the overall value of a Sub-Fund and thus the NAV per Share may be adjusted in order to avoid disadvantaging the value of investments for existing Shareholders. The size of the adjustment impact is determined by factors such as the volume of transactions, the purchase or sale prices of the underlying assets and the valuation method adopted to calculate the value of such underlying assets of the Sub-Fund.

Distribution out of Capital Risk

The Company may launch Classes whose distribution policy deviates from the regular distribution policy, and which may provide for distributions out of capital in accordance with Article 31 of the Law. The payment of distributions out of capital represents a return or withdrawal of part of the amount which the investors originally invested and/or capital gains attributable to the original investment. Investors should be aware that any distributions involving payment of distributions out of a Sub-Fund's capital may result in an immediate decrease in the Net Asset Value per Share and may reduce the capital available for such Sub-Fund for future investment and capital growth. As a result, such investors' investment in the Sub-Fund will be adversely affected. The distribution amount and NAV of any hedged share classes of the Sub-Fund may be adversely affected by differences in the

interest rates of the reference currency of the hedged share classes and the base currency of the Sub-Fund, resulting in an increase in the amount of distribution that is paid out of capital and hence a greater erosion of capital than other non-hedged share classes. Distribution Share applying the Fixed Percentage Policy have a relatively high risk of distributions exceeding realised capital gains and other income. This may result in an immediate decrease in the Net Asset Value per Share and may reduce relatively larger portion of capital available for such Sub-Fund for future investment and capital growth, potentially eroding the capital more quickly.

Early Liquidation Risk

As may be determined by the Board, a Sub-Fund may be liquidated under certain circumstances as set out under "Liquidation and Merger" of the HK Prospectus. In the event of a Sub-Fund's liquidation, the Sub-Fund would have to distribute to Shareholders their pro rata interest in the assets of the Sub-Fund. It is possible that at the time of a sale or distribution, certain assets held by the relevant Sub-Fund may be worth less than their initial cost, resulting in a loss to shareholders.

European Country Risk

In light of the fiscal conditions and concerns regarding the sovereign debt of certain European countries, investments of a Sub-Fund in Europe may be subject to a number of risks arising from a potential crisis in Europe. The economic and financial difficulties in Europe may continue to get worse or spread within and outside Europe and may lead to one or several countries exiting the Eurozone and/or exiting the EU or default of a sovereign within the Eurozone and/or within the EU, potentially resulting in the breakup of the EU, the Eurozone and the Euro.

While the governments of many European countries (including the EU Member States), the European Commission, the European Central Bank, the International Monetary Fund and other authorities are taking measures (such as undertaking economic reforms and imposing austerity measures on citizens) to address the current fiscal conditions and concerns, these measures may not have their desired effect, and the future stability and growth of Europe is therefore uncertain. The impact of such events on the Sub-Funds which are denominated in Euro, or which invest in instruments predominantly tied to Europe may be significant and the NAV of such Sub-Funds may be adversely affected by the increased risks (such as increased volatility, liquidity and currency risks associated with investments in Europe).

Emerging Markets Risk

A Sub-Fund's investments in Emerging Markets are subject to greater liquidity risk, currency risk and general market risk. Increased risks may arise in connection with the settlement of securities transactions in Emerging Markets, especially as it may not be possible to deliver securities directly when payment is made. In addition, the legal, taxation and regulatory environment, as well as the accounting, auditing, and reporting standards in Emerging Markets may deviate substantially to the detriment of the investors from the levels and standards that are considered standard international practice. Increased custodial risk in Emerging Markets may also arise, which may result from differing disposal methods for acquired assets. Such increased risks may have an adverse impact on the relevant Sub-Fund and/or the investors.

General Market Risk

To the extent that a Sub-Fund invests directly or indirectly in securities or other assets, it is exposed to various general trends and tendencies in the economic and political situation as well as securities markets and investment sentiment, which are partially attributable to irrational factors. Such factors could lead to substantial and longer-lasting drops in securities prices affecting the entire market and the value of a Sub-Fund's investments may be negatively affected.

Index-based Investment Risk

With respect to index-based investments, the composition of an index and the weighting of individual components may change during the time a position is held. Further, index levels are neither current nor based on current data. These factors can have negative effects on such investments.

Inflation Risk

Inflation risk is the risk that assets will lose value because of a decrease in the value of money. Inflation can reduce the purchasing power of income made on an investment in a Sub-Fund as well as the intrinsic value of the investment. This could have a negative effect on an investor's investment. Different currencies are subject to different levels of inflation risk.

Instruments with Loss-absorption Features Risk

A Sub-Fund may invest in instruments with loss-absorption features which are subject to greater risks when compared to traditional debt instruments as such instruments typically include terms and conditions specifying that the instrument is subject to being partly or wholly written off, written down, or converted to ordinary shares of the issuer upon the occurrence of a pre-defined trigger event. Trigger events are likely to be outside of the issuer's control and commonly include a reduction in the issuer's capital ratio below a specified level or upon specific government or regulatory action being taken as a result of the issuer's ongoing financial viability. Trigger events are complex and difficult to predict and can result in a significant or total reduction in the value of such instruments, giving rise to consequential loss of a Sub-Fund.

Contingent convertible bonds are typical instruments with loss-absorption features, please also refer to the risk factor "Contingent Convertible Bonds Investment Risk".

Interest Rate Risks

To the extent that a Sub-Fund invests directly or indirectly in Debt Securities, it is exposed to interest-rate risk. If market interest rates rise, the value of the interest-bearing assets held by the Sub-Fund may decline substantially and negatively affect the performance of such Sub-Fund. This applies to an even greater degree if such Sub-Fund also holds Debt Securities with a longer time to maturity and a lower nominal interest rate.

Issuer Default Risk

The issuer of a security directly or indirectly held by a Sub-Fund or the debtor of a claim belonging to a Sub-Fund may become insolvent causing its inability to fulfil his payment obligations in a full and timely manner. Risks of losses arising from the issuer's default and causing such issued assets (see Defaulted Securities Risk) to become economically worthless.

Key Personnel Risk

Sub-Funds that achieve very positive results in a certain period of time may owe this success to the aptitude of the traders and the correct decisions of their management. If staffing at a fund changes, new decision makers may have less success in managing the Sub-Fund's assets, which may have a negative impact on the performance of such Sub-Fund.

Legal Risk

Legal risks can bear the risk of loss because of the unexpected application of a law or regulation or because a contract cannot be enforced. In case of collateralized transactions, there is the risk that the relevant insolvency law may impose a stay that prevents the collateral taker from liquidating the collateral, even if the collateral arrangement has been set up correctly.

Liquidity Risk

Investments in securities in certain developing markets may be subject to higher volatility and lower liquidity compared to more developed markets. Even relatively small orders of illiquid securities can lead to significant price changes. If an asset is illiquid, there is the risk that the asset cannot be sold or can only be sold at a significant discount to the purchase price, or, conversely, its purchase price may increase significantly. Such price changes may adversely impact the NAV of a Sub-Fund.

Local Tax Risk

As a result of local regulations, a Sub-Fund's assets may, from time to time, be subject to taxes, fees, charges and other retentions. This applies in particular to revenues or gains from the sale, redemption or restructuring of the Sub-Fund's assets, cash flow-free restructuring of such assets, and/or changes related to settlement and dividends, interest and other income received by the Sub-Fund. Certain taxes or charges (e.g., all charges collected under FATCA), may be collected in the form of withholding tax or a retention when paying out or forwarding payments. Certain taxes or withholdable payments collected under FATCA may be collected in the form of a withholding tax on the Sub-Fund or in form of a withholding tax on "passthrough payments" on the individual shareholder (to the extent provided in future regulations which will be subject to further changes, but in no event before 1 January 2017). Although the Company will attempt to satisfy any obligations imposed on it to avoid the imposition of the FATCA withholding tax, no assurance can be given that the Company will be able to satisfy these obligations. Withholding on passthrough payments by the Company will be permitted under applicable laws and regulations and in which case the Company will act in good faith and on reasonable grounds. If the Company becomes subject to a withholding tax as a result of the FATCA regime, the value of the Shares held by Shareholders may suffer material losses.

Negative Interest on Cash Accounts Risk

The Company invests the liquid asset of the Sub-Funds at the Depositary or other banks for account of the Sub-Funds. Depending on the market development, in particular the development of the interest policy of the European Central Bank, short-, medium- and long-term bank deposits may have negative interest rates which will be charged to the Sub-Funds. Such interest charges may adversely impact the net asset value of the Sub-Funds.

New Sub-Fund Launch, Merger or Liquidation Risk

Certain investment restrictions applicable to a Sub-Fund need not be adhered to during the period following the launch of a Sub-Fund or before a Sub-Fund undergoes a merger or liquidation (for further details, please refer to Appendix 1 Part A). The performance of a Sub-Fund in the above period(s) may be different from what it would otherwise be had the relevant investment restrictions been strictly adhered to by that Sub-Fund during such periods.

Non-investment Grade Sovereign Debt Securities Risk

The Sub-Fund may invest in Debt Securities issued or guaranteed by a non-investment grade sovereign issuer and is therefore subject to higher credit/default risk and concentration risk as well as greater volatility and higher risk profile. In addition, there are no bankruptcy proceedings for such securities on which money to pay the obligations of the securities may be collected in whole or in part. Shareholders may be requested to participate in the rescheduling of such securities and to extend further loans to the issuers. In the event of default of the sovereign issuer, the Sub-Fund may suffer significant losses.

Operational Risk

The Company may be exposed to a risk of loss which can arise, for example, from inadequate internal processes and from human error or system failure at the Company, at the Management Company, at the Investment Manager, at the Custodian or at external third parties. These risks can affect the performance of a Sub-Fund, can thus also adversely affect the net asset value per share and the capital invested by the shareholder.

Performance Risk

It cannot be guaranteed that the investment objective of a Sub-Fund or the investment performance desired by the investors will be achieved. The Net Asset Value per Share may fluctuate and may fall, causing investors to incur losses. Investors assume the risk of potentially receiving back a lesser amount of principal than they originally invested. No guarantees are issued by the Company or any third party of any outcome for an investment in any of the Sub-Funds.

Restricted Flexibility Risk

The redemption of Shares may be subject to restrictions. If the redemption of Shares is suspended or delayed, investors will not be able to redeem their Shares and will be compelled to remain invested in the Sub-Fund for a longer period of time than originally intended or desired and their investments continue to be subject to the risks inherent to such Sub-Fund. If a Sub-Fund or Class is dissolved, or if the Company exercises the right to compulsorily redeem Shares, investors will no longer be so invested. The same applies if a Sub-Fund or Class held by the investors merges with another fund, Sub-Fund or Class, in which case the investors shall automatically become holders of shares in such other fund, or Shares in another Sub-Fund or Class. The sales charge levied when Shares are acquired could reduce or even eliminate any gains on an investment, particularly if the investment is held for only a short period of time. If Shares are redeemed in order to invest the proceeds in another type of investment, investors may, in addition to the costs already incurred (e.g., sales charge), incur other costs such as a redemption fee and/or a disinvestment fee for the Sub-Fund held or extra sales charges for the purchase of other shares. These events and circumstances could result in losses to the investor.

Risk Associated with the Receipt of Collateral

The Company may receive collateral e.g., for OTC derivatives. Derivatives may increase in value. Therefore, collateral received may no longer be sufficient to fully cover the Company's claim for delivery or redemption of collateral against a counterparty. The Company may deposit cash collateral in blocked accounts or invest it in high quality government bonds or in money market funds with a short-term maturity structure. Though, the credit institution that safe keeps the deposits may default; the performance of government bonds and money market funds may be negative. Upon completion of the transaction, the collateral deposited or invested may no longer be available to the full extent, although the Company is obligated to redeem the collateral at the amount initially granted. Therefore, the Company may be obliged to increase the collateral to the amount granted and thus compensate the losses incurred by the deposit or investment of collateral.

Risk Associated with Collateral Management

Collateral management requires the use of systems and certain process definitions. Failure of processes as well as human or system errors at the level of the Company, the Management Company or third parties in relation to collateral management could entail the risk that assets, serving as collateral, lose value and are no longer sufficient to fully cover the Company's claim for delivery or transfer back of collateral against a counterparty.

Settlement Risk

There is a risk for investments in unlisted securities that the settlement will not be executed as expected by a transfer system owing to a delayed payment or delivery or payment not being made in accordance with the agreement. This may lead to a fall in the NAV of a Sub-Fund.

Share Class Liability Risk

Classes of a Sub-Fund are not separate legal entities. In relation to third parties, the assets allocated to a certain Class are not liable for just the debts and liabilities that can be allocated to that Class. If the assets of a Class are insufficient to cover the liabilities that can be allocated to such Class, those liabilities may have the effect of reducing the NAV of other Classes of the same Sub-Fund. Any reduction in NAV will have a negative impact on the relevant investor's investment.

Share Movements Risk

The issue of Shares may lead to the investment of the cash inflow. Redemptions of Shares may lead to the disposal of investments to achieve liquidity. Such transactions can give rise to costs that could have a substantial negative effect on the performance of a Sub-Fund if Shares issued and redeemed on a single day do not approximately offset one another.

Small capitalisation / Mid capitalisation Companies Risk

The Equities of small capitalisation/mid capitalisation companies may have lower liquidity and their prices are more volatile to adverse economic developments than those of larger capitalization companies in general.

Sovereign Debt Risk

Debt Securities issued or guaranteed by governments, or their agencies ("Sovereign Debt Securities") may be exposed to political, social and economic risks. There is a risk that even governments or their agencies may default or not be able or willing to repay the principal and/or interest. In addition, there are no bankruptcy proceedings for Sovereign Debt Securities on which money to pay the obligations of Sovereign Debt Securities may be collected in whole or in part. Holders of Sovereign Debt Securities may therefore be requested to participate in the rescheduling of Sovereign Debt Securities and to extend further loans to the issuers of Sovereign Debt Securities. The Sub-Fund may suffer significant losses when there is a default of the Issuers of Sovereign Debt Securities. A Sub-Fund may invest all, or a significant part, of its assets, in Sovereign Debt Securities issued guaranteed by a single government or from agencies of the same government.

Sustainability Risk

means an environmental, social or governance event or condition that, if it occurs, could cause an actual or a potential material negative impact on the value of the investment. There is systematic research evidence that sustainability risks may materialize as issuer specific extreme loss-risks. Such issuer specific sustainability risk events typically happen with low frequency and probability but may have high financial impact and may lead to significant financial loss. Sustainability Risks may have the potential to influence the investment performance of portfolios negatively. Allianz Global Investors considers Sustainability Risks to be potential drivers of financial risk factors in investments such as market price risk, credit risk, liquidity risk and operational risk.

Target Funds Risk

If a Sub-Fund uses other funds (“target funds”) as an investment vehicle for its assets by acquiring shares in such target funds, it assumes, in addition to the risks generally associated with investment policies of the target funds, the risks that result from the structure of the “fund” vehicle. As a result, it is itself subject to the capital risk, the settlement risk, the risk of restricted flexibility, the risk of changes to underlying conditions, the risk of changes to terms and conditions, the investment policy and other basic aspects of a fund, the key personnel risk, the risk of transaction costs at the fund level arising from share movements and, in general, performance risk. If the investment policy of a target fund makes use of investment strategies that are oriented toward rising markets, the corresponding positions should generally have a positive effect on target fund assets when markets are rising and a negative effect when markets are falling. If the investment policy of a target fund makes use of investment strategies that are oriented toward falling markets, the corresponding positions should generally have a positive effect on target fund assets when markets are falling and a negative effect when markets are rising.

The target fund managers of different funds operate independently of one another. This may lead to several target funds assuming opportunities and risks in the same or related markets or assets, which concentrates the opportunities and risks of the Sub-Fund holding these target funds on the same or related markets or assets. It could also have the effect of cancelling out the economic opportunities and risks assumed by the different target funds.

If a Sub-Fund invests in target funds, costs are regularly incurred both at the level of the Sub-Fund making the investment and at the level of the target funds, in particular, all-in-fees, management fees (fixed and/or performance related), depositary fees and other costs. These may result in increased charges to the investors in the Sub-Fund making the investment.

Use of Derivatives Risk

A Sub-Fund may use derivatives – such as futures, options and swaps – for efficient portfolio management (including hedging) purposes. This may lead to correspondingly lower opportunities and risks in the general Sub-Fund profile. Hedging can be used in particular to reflect the different currency-hedged Share Classes and thus to mark the profile of the respective Share Class.

A Sub-Fund may also employ derivatives in a speculative sense in order to increase returns in pursuing the investment objective, in particular, to represent the general Sub-Fund’s profile and to increase the level of investment above the level of investment of a fund that is fully invested in securities. In reflecting the general Sub-Fund’s profile through derivatives, the general Sub-Fund’s profile will be implemented through the replacement of direct investments in securities, for example, by investments in derivatives or also, in shaping the general Sub-Fund’s profile, specific components of the individual investment objectives and restrictions may be derivative based, for example reflecting currency positions through investments in derivatives, which normally will not have a substantial effect on the general Sub-Fund’s profile. In particular, if the individual investment objectives and restrictions states that, with the objective of achieving additional returns, the Investment Managers may also assume separate foreign currency risks with regard to certain currencies and/or separate risks with regard to Equities, Debt Securities and/or commodity futures indices and/or precious metals indices and/or commodity indices these components of the individual investment objectives and restrictions are predominately derivative based.

If a Sub-Fund employs derivatives to increase the level of investment (investment purposes), it does so in order to achieve a medium to long-term risk profile that offers potentially much greater market risk than that of a fund with a similar profile that does not invest in derivatives. However, to this end the Investment Manager may employ derivatives as it sees fit, including very high levels of derivatives, which – relative to a fund that does not invest in derivatives with a similar profile – could result in very high additional opportunities and very high risks during certain phases. A Sub-Funds Investment Manager follows a risk-controlled approach in the use of derivatives.

Valuation Risk

Valuation of a Sub-Fund’s investments may involve uncertainties and judgmental determinations. If such valuation turns out to be incorrect, this may affect the NAV calculation of the Sub-Fund.

2. Sub-Fund-Specific Risk Factors

China Investment Risk

Various Sub-Funds invest in the Equity Markets and/or Debt Securities Markets of the PRC. There are numerous and varied risks associated with such an investment which are referred to as the "China Investment Risk". Independent if a Sub-Funds invests in the Equity Markets and/or in the Debt Securities Markets of the PRC, the following risks are generally associated with such an investment, in the PRC:

FII Risk

A Sub-Fund may invest in securities and investments permitted to be held or made by FII under the relevant FII Regulations through institutions that have obtained FII status in China. In addition to the general investment and equity related risks of investments including in particular the Emerging Markets risks, the following risks should be emphasised:

Regulatory Risks

The FII regime is governed by FII Regulations. Certain parts of the Allianz Global Investors Group meet the relevant prescribed eligibility requirements under the FII Regulations and have been granted or might be granted a FII license. FII Regulations may be amended from time to time. It is not possible to predict how such changes would affect the relevant Sub-Fund.

Rules on investment restrictions and rules on repatriation of principal and profits, imposed by the Chinese government on the FII may be applicable to the latter as a whole and not only to the investments made by the relevant Sub-Fund and may have an adverse effect on the Sub-Fund's liquidity and performance.

FII Investments Risks

Investors should be aware that there can be no assurance that a FII will continue to maintain its FII status and/or that redemption requests can be processed in a timely manner due to changes in FII Regulations. Therefore, a Sub-Fund may no longer be able to invest directly in the PRC or may be required to dispose of its investments in the PRC domestic securities market held by the FII, which could have an adverse effect on its performance or result in a significant loss.

Regulatory sanctions may be imposed on the FII if the FII itself or the local custodian breach any provision of the relevant rules and regulations.

Such restriction may result in a rejection of applications or a suspension of dealings of the Sub-Fund. Should the FII lose its FII status or retire or be removed, the relevant Sub-Fund may not be able to invest in FII Eligible Securities, and the relevant Sub-Fund may be required to dispose of its holdings, which would likely have a material adverse effect on the Sub-Fund.

Limits on Redemption

A Sub-Fund may be impacted by the rules and restrictions under the FII regime (including investment restrictions, limitations on foreign ownership or holdings), which may have an adverse impact on its performance and/or its liquidity. Currently, no regulatory prior approval is required for repatriation of funds from the FII. However, the FII Regulations are subject to uncertainty in their application and there is no certainty that no other regulatory restrictions will apply or that repatriation restrictions will be imposed in the future. Although the relevant FII Regulations have recently been revised to relax regulatory restrictions on the onshore capital management by FIIs (including removing investment quota limit and simplifying process for repatriation of investment proceeds), it is a very new development therefore subject to uncertainties as to how well it will be implemented in practice, especially at the early stage.

Any restrictions on repatriation of the invested capital and net profits may impact on the relevant Sub-Fund's ability to meet redemption requests from the Shareholders. In extreme circumstances, the relevant Sub-Fund may incur significant loss due to limited investment capabilities or may not be able fully to implement or pursue its investment objectives or strategies, due to FII investment restrictions, illiquidity of the PRC's securities market, and delay or disruption in execution of trades or in settlement of trades.

PRC Depository Risks under the FII regime

Where a Sub-Fund invests in fixed income securities and/or eligible securities through the FII, such securities will be maintained by a local custodian pursuant to PRC regulations through appropriate securities accounts and such other relevant depositories in such name as may be permitted or required in accordance with PRC law.

The Sub-Fund may incur losses due to the acts or omissions of the PRC Depository in the execution or settlement of any transaction.

The Depository will make arrangements to ensure that the relevant PRC Depository has appropriate procedures to properly safe keep the assets of the relevant Sub-Fund. The securities accounts are to be maintained and recorded in the joint name of the FII and the relevant Sub-Fund and segregated from the other assets of the same local custodian. However, the FII Regulations are subject to the interpretation of the relevant authorities in the PRC.

Any securities acquired by the relevant Sub-Fund held by the FII will be maintained by the PRC Depository and should be registered in the joint names of the FII and the Sub-Fund and for the sole benefit and use of such Sub-Fund. Providing that the FII will be the party entitled to the securities, the related security may be vulnerable to a claim by a liquidator of the FII and may not be as well protected as if they were registered solely in the name of the respective Sub-Fund.

In addition, investors should note that cash deposited in the cash account of the relevant Sub-Fund with the relevant local custodian will not be segregated but will be a debt owing from the local custodian to the relevant Sub-Fund as a depositor. Such cash will be co-mingled with cash belonging to other clients of that local custodian. In the event of bankruptcy or liquidation of the local custodian, the relevant Sub-Fund will not have any proprietary rights to the cash deposited in such cash account, and the relevant Sub-Fund will become an unsecured creditor, ranking equal with all other unsecured creditors, of the local custodian. The relevant Sub-Fund may face difficulty and/or encounter delays in recovering such debt or may not be able to recover it in full or at all, in which case the Sub-Fund will suffer losses.

PRC Broker Risks under the FII regime

The execution and settlement of transactions may be conducted by PRC Brokers appointed by the FII, as the case may be. There is a risk that a Sub-Fund may suffer losses from the default, bankruptcy, or disqualification of the PRC Brokers. In such event, the Sub-Fund may be adversely affected in the execution or settlement of any transaction.

In selection of PRC Brokers, the FII will have regard to factors such as the competitiveness of commission rates, size of the relevant orders and execution standards. If the FII, as the case may be, consider appropriate and if under market or operational constraints, it is possible that a single PRC Broker will be appointed, and the Sub-Fund may not necessarily pay the lowest commission or spread available in the market at the relevant time.

PRC Tax Provision Risk

If no or inadequate provision for potential withholding tax is made and, in the event, that the PRC tax authorities enforce the imposition of such withholding tax, the Net Asset Value of the relevant Sub-Funds may be adversely affected. For any withholding tax made in respect of trading of PRC securities, it may reduce the income from, and/or adversely affect the performance of, the relevant Sub-Fund. With respect to CIBM, the amount withheld (if any) will be retained by the Investment Manager for the account of the relevant Sub-Fund until the position with regard to PRC taxation in respect of gains and profits from trading via the CIBM has been clarified. In the event that such position is clarified to the advantage of the relevant Sub-Fund, the Company may rebate all or part of the withheld amount to the Sub-Fund. The withheld amount (if any) so rebated shall be retained by the Sub-Fund and reflected in the value of its Shares. Notwithstanding the foregoing, no Shareholder who redeemed his/her Shares before the rebate of any withheld amounts shall be entitled to claim any part of such rebate.

It should also be noted that the actual applicable tax imposed by the PRC tax authorities may be different and may change from time to time. There is a possibility of the rules being changed and taxes being applied retrospectively. Any increased tax liabilities on a Sub-Fund may adversely affect the Sub-Fund's value. As such, any provision for taxation made by the Investment Manager for the account of the relevant Sub-Fund may be excessive or inadequate to meet final PRC tax liabilities. Consequently, Shareholders of the relevant Sub-Fund may be advantaged or disadvantaged depending upon the final tax liabilities, the level of provision and when they subscribed and/or redeemed their Shares in/from the relevant Sub-Fund.

If the actual applicable tax levied by the PRC tax authorities is higher than that provided for by the Investment Manager so that there is a shortfall in the tax provision amount, investors should note that the Net Asset Value of the Sub-Fund may suffer more than the tax provision amount as that Sub-Fund will ultimately have to bear the additional tax liabilities. In this case, the then existing and new Shareholders will be disadvantaged. On the other hand, if the actual applicable tax rate levied by the PRC tax authorities is lower than that provided for by the Manager so that there is an excess in the tax provision amount, Shareholders who have redeemed Shares in the relevant Sub-Fund before the PRC tax authorities' ruling, decision or guidance in this respect will be disadvantaged as they would have borne the loss from the Investment Manager's over-provision. In this case, the then existing and new Shareholders may benefit if the difference between the tax provision and the actual taxation liability under that lower tax amount can be returned to the account of the Sub-Fund as assets thereof.

Investors should seek their own tax advice on their own tax position with regard to their investment in the relevant Sub-Fund.

It is possible that the current tax laws, regulations and practice in the PRC will change, including the possibility of taxes being applied retrospectively, and that such changes may result in higher taxation on PRC investments than is currently contemplated.

RMB Risk

Investors should be aware that the RMB is subject to a managed floating exchange rate based on market supply and demand with reference to a basket of currencies. Currently, RMB is traded in PRC ("CNY") and outside PRC ("CNH"). RMB traded in PRC, CNY, is not freely convertible and is subject to exchange control policies and restrictions imposed by the PRC authorities. On the other hand, the RMB traded outside the PRC, CNH, is freely tradeable but still subject to controls, limits and availability. In general, the respective daily exchange rate of the RMB against other currencies is allowed to float within a range above or below the central parity rates published by the People's Bank of China ("PBOC") each day. Its exchange rate against other currencies, including e.g., USD or HKD, is therefore susceptible to movements based on external factors. There can be no assurance that such exchange rates will not fluctuate widely.

While CNY and CNH represent the same currency, they are traded on different and separate markets which operate independently. As such, the value of CNH could differ, perhaps significantly, from that of CNY and the exchange rate of CNH and CNY may not move in the same direction due to a number of factors including, without limitation, the foreign exchange control policies and repatriation restrictions pursued by the PRC government from time-to-time, as well as other external market forces.

Under exceptional circumstances, payment of redemptions and/or dividend payment in RMB may be delayed due to the exchange controls and restrictions applicable to RMB.

There is no assurance that RMB will not be subject to devaluation, in which case the value of investors' investments in RMB assets will be adversely affected.

Currently, the PRC government imposes certain restrictions on repatriation of RMB out of the PRC. Investors should note that such restrictions may limit the depth of the RMB market available outside of the PRC and thereby, may reduce the liquidity of the Sub-Fund.

The PRC government's policies on exchange controls and repatriation restrictions are subject to change, and the Sub-Fund's and its investors' position may be adversely affected by such change.

With regard to Share Classes denominated in RMB investors, who invest in such Share Classes, should pay particular attention to this risk warning.

For Sub-Funds which may invest into the Equity Markets of the PRC the following risks apply additionally:

Investing in China A-Shares Risk

The securities market in the PRC, including China A-Shares, may be more volatile, and unstable (for example, due to the risk of suspension /limitation in trading of a particular stock or government intervention) than markets in more developed countries and has potential settlement difficulties. This may result in significant fluctuations in the prices of securities traded in such market and thereby affecting the prices of shares of the Sub-Fund.

Investment in the PRC remains sensitive to any major change in economic, social and political policy in the PRC. The capital growth and thus the performance of these investments may be adversely affected due to such sensitivity.

Utilising Stock Connect Programmes Risk

The Shanghai-Hong Kong Stock Connect comprises a Northbound Shanghai Trading Link and a Southbound Hong Kong Trading Link. Under the Northbound Shanghai Trading Link, Hong Kong and overseas investors (including the relevant Sub-Funds), through their Hong Kong brokers and a securities trading service company established by SEHK, may be able to trade eligible China A-Shares listed on the SSE by routing orders to the SSE. Under the Southbound Hong Kong Trading Link under the Shanghai-Hong Kong Stock Connect, investors in the PRC will be able to trade certain stocks listed on the SEHK.

Under the Shanghai-Hong Kong Stock Connect, the relevant Sub-Funds, through their Hong Kong brokers may trade certain eligible shares listed on the SSE ("SSE Securities"). These include all the constituent stocks from time to time of the SSE 180 Index and SSE 380 Index, and all the SSE-listed China A-Shares that are not included as constituent stocks of the relevant indices, but which have corresponding H-Shares listed on SEHK, except the following:

- SSE-listed shares which are not traded in RMB,
- SSE-listed shares which are included in the "risk alert board", and
- SSE-listed shares which are subject to delisting process or the listing of which has been suspended by SSE.

It is expected that the list of eligible securities will be subject to review.

The trading is subject to rules and regulations issued from time to time. Trading under the Shanghai-Hong Kong Stock Connect is subject to a daily quota ("Daily Quota"). Northbound Shanghai Trading Link and Southbound Hong Kong Trading Link under the Shanghai-Hong Kong Stock Connect will be subject to a separate set of Daily Quota. The Daily Quota limits the maximum net buy value of cross-boundary trades under the Shanghai-Hong Kong Stock Connect each day.

The Shenzhen-Hong Kong Stock Connect comprises a Northbound Shenzhen Trading Link and a Southbound Hong Kong Trading Link. Under the Northbound Shenzhen Trading Link, Hong Kong and overseas investors (including the relevant Sub-Funds), through their Hong Kong brokers and a securities trading service company established by SEHK, may be able to trade eligible China A-Shares listed on the SZSE by routing orders to SZSE. Under the Southbound Hong Kong Trading Link under the Shenzhen-Hong Kong Stock Connect investors in the PRC will be able to trade certain stocks listed on the SEHK.

Under the Shenzhen-Hong Kong Stock Connect, the relevant Sub-Funds, through their Hong Kong brokers may trade certain eligible shares listed on the SZSE ("SZSE Securities"). These include any constituent stock of the SZSE Component Index and SZSE Small/Mid Cap Innovation Index which has a market capitalisation of not less than RMB6 billion and all SZSE-listed China A-Shares which have corresponding H Shares listed on the SEHK except for the following:

- SZSE-listed shares which are not traded in RMB,
- SZSE-listed shares which are included in the "risk alert board", and
- SZSE-listed shares which are subject to delisting process or the listing of which has been suspended by SZSE.

At the initial stage of the Northbound Shenzhen Trading Link, investors eligible to trade shares that are listed on the ChiNext Board of SZSE under the Northbound Shenzhen Trading Link will be limited to institutional professional investors as defined in the relevant Hong Kong rules and regulations.

It is expected that the list of eligible securities will be subject to review.

The trading is subject to rules and regulations issued from time to time. Trading under the Shenzhen-Hong Kong Stock Connect will be subject to a Daily Quota. Northbound Shenzhen Trading Link and Southbound Hong Kong Trading Link under the Shenzhen-Hong Kong Stock Connect will be subject to a separate set of Daily Quota. The Daily Quota limits the maximum net buy value of cross-boundary trades under the Shenzhen-Hong Kong Stock Connect each day.

HKSCC, a wholly owned subsidiary of the Hong Kong Exchanges and Clearing Limited, and ChinaClear will be responsible for the clearing, settlement and the provision of depository, nominee and other related services of the trades executed by their respective market participants and/or investors. The China A-Shares traded through Stock Connect are issued in scripless form, and investors will not hold any physical China A-Shares.

Although HKSCC does not claim proprietary interests in the SSE Securities and SZSE Securities held in its omnibus stock accounts in ChinaClear, ChinaClear as the share registrar for SSE and SZSE listed companies will still treat HKSCC as one of the shareholders when it handles corporate actions in respect of such SSE Securities and SZSE Securities.

SSE/SZSE listed companies usually announce information regarding their annual general meetings/extraordinary general meetings about two to three weeks before the meeting date. A poll is called on all resolutions for all votes. HKSCC will inform the Hong Kong Central Clearing and Settlement System ("CCASS") participants of all general meeting details such as meeting date, time, venue and the number of proposed resolutions.

Under the Stock Connect, Hong Kong and overseas investors will be subject to the fees and levies imposed by SSE, SZSE, ChinaClear, HKSCC or the relevant Mainland Chinese authority when they trade and settle SSE Securities and SZSE Securities.

Further information about the trading fees and levies is available online at the website:

http://www.hkex.com.hk/eng/market/sec_tradinfra/chinaconnect/chinaconnect.htm

In accordance with the UCITS requirements, the Depositary shall provide for the safekeeping of the relevant Sub-Fund's assets in the PRC through its global custody network. Such safekeeping is in accordance with the conditions set down by the CSSF which provides that there must be legal separation of non-cash assets held under custody and that the Depositary through its delegates must maintain appropriate internal control systems to ensure that records clearly identify the nature and amount of assets under custody, the ownership of each asset and where documents of title to each asset are located.

A Sub-Fund may invest in China A-Shares via the Stock Connect. In addition to the general investment and equity related risks including Emerging Markets risks and risks regarding RMB, the following risks should be emphasised:

Quota Limitations

The Stock Connect is subject to quota limitations. In particular, the Stock Connect is subject to a daily quota which does not belong to the relevant Sub-Fund and can only be utilised on a first-come-first-serve basis. Once the daily quota is exceeded, buy orders will be rejected (although investors will be permitted to sell their cross-boundary securities regardless of the quota balance). Therefore, quota limitations may restrict the relevant Sub-Fund's ability to invest in China A Shares through the Stock Connect on a timely basis, and the relevant Sub-Fund may not be able to effectively pursue its investment strategy.

Legal / Beneficial Ownership

The SSE and SZSE shares in respect of the Funds are held by the Depositary/ sub-custodian in accounts in the CCASS maintained by the HKSCC as central securities depositary in Hong Kong. HKSCC in turn holds the SSE and SZSE shares, as the nominee holder, through an omnibus securities account in its name registered with ChinaClear for each of the Stock Connects. The precise nature and rights of the Funds as the beneficial owners of the SSE and SZSE shares through HKSCC as nominee is not well defined under PRC law. There is lack of a clear definition of, and distinction between, "legal ownership" and "beneficial ownership" under PRC law and there have been few cases involving a nominee account structure in the PRC courts. Therefore, the exact nature and methods of enforcement of the rights and interests of the Funds under PRC law is uncertain. Because of this uncertainty, in the unlikely event that HKSCC becomes subject to winding up proceedings in Hong Kong it is not clear if the SSE and SZSE shares will be regarded as held for the beneficial ownership of the Funds or as part of the general assets of HKSCC available for general distribution to its creditors.

Clearing and Settlement Risk

HKSCC and ChinaClear have established the clearing links and each has become a participant of the other to facilitate clearing and settlement of cross-boundary trades. For cross-boundary trades initiated in a market, the clearing house of that market will on one hand clear and settle with its own clearing participants, and on the other hand undertake to fulfil the clearing and settlement obligations of its clearing participants with the counterparty clearing house.

As the national central counterparty of the PRC's securities market, ChinaClear operates a comprehensive network of clearing, settlement and stock holding infrastructure. ChinaClear has established a risk management framework and measures that are approved and supervised by the CSRC. The chances of ChinaClear default are considered to be remote. In the remote event of a ChinaClear default, HKSCC's liabilities in SSE and SZSE Securities under its market contracts with clearing participants will be limited to assisting clearing participants in pursuing their claims against ChinaClear. HKSCC will in good faith, seek recovery of the outstanding stocks and monies from ChinaClear through available legal channels or through ChinaClear's liquidation. In that event, the relevant Sub-Fund may suffer delay in the recovery process or may not fully recover its losses from ChinaClear.

Suspension Risk

Each of the SEHK, SSE and SZSE reserves the right to suspend trading, if necessary, for ensuring an orderly and fair market and that risks are managed prudently. Consent from the relevant regulator would be sought before a suspension is triggered. Where a suspension is affected, the relevant Sub-Fund's ability to access the PRC market will be adversely affected.

Differences in Trading Day

The Stock Connect only operates on days when both the PRC and Hong Kong markets are open for trading and when banks in both markets are open on the corresponding settlement days. So, it is possible that there are occasions when it is a normal trading day for the PRC market but the relevant Sub-Funds cannot carry out any China A-Shares trading via the Stock Connect. The relevant Sub-Funds may be subject to a risk of price fluctuations in China A-Shares during the time when any of the Stock Connect is not trading as a result.

Restrictions on Selling Imposed by Front-end Monitoring

PRC regulations require that before an investor sells any share, there should be sufficient shares in the account; otherwise, the SSE or SZSE will reject the sell order concerned. SEHK will carry out pre-trade checking on China A-Shares sell orders of its participants (i.e., the stockbrokers) to ensure there is no over-selling.

If a relevant Sub-Fund intends to sell certain China A-Shares it holds, it must transfer those China A-Shares to the respective accounts of its broker(s) before the market opens on the day of selling ("trading day"). If it fails to meet this deadline, it will not be able to sell those shares on the trading day. Because of this requirement, the relevant Sub-Fund may not be able to dispose of its holdings of China A-Shares in a timely manner.

Operational Risk

The Stock Connect is premised on the functioning of the operational systems of the relevant market participants. Market participants are permitted to participate in this program subject to meeting certain information technology capability, risk management and other requirements as may be specified by the relevant exchange and/or clearing house.

The securities regimes and legal systems of the two markets differ significantly and market participants may need to address issues arising from the differences on an on-going basis. There is no assurance that the systems of the SEHK and market participants will function properly or will continue to be adapted to changes and developments in both markets. In the event that the relevant systems fail to function properly, trading in both markets through the program could be disrupted. The relevant Sub-Fund's ability to access the China A-Shares market (and hence to pursue its investment strategy) may be adversely affected.

Regulatory Risk

The current regulations relating to Stock Connect are relatively new and subject to continuous evolution. In addition, the current regulations are subject to change which may have potential retrospective effects and there can be no assurance that the Stock Connect will not be abolished. New regulations may be issued from time to time by the regulators / stock exchanges in the PRC and Hong Kong in connection with operations, legal enforcement and cross-border trades under the Stock Connect. The relevant Sub-Funds may be adversely affected as a result of such changes.

Recalling of Eligible Stocks

When a stock is recalled from the scope of eligible stocks for trading via the Stock Connect, the stock can only be sold but restricted from being bought. This may affect the investment portfolio or strategies of the relevant Sub-Funds, for example, if the Investment Manager wishes to purchase a stock which is recalled from the scope of eligible stocks.

Risks associated with the ChiNext Market

The relevant Sub-Fund may invest in the ChiNext Board of the SZSE ("ChiNext Board"). Investments in the ChiNext Board may result in significant losses for the relevant Sub-Fund and its investors. The following additional risks apply:

Higher Fluctuation on Stock Prices

Listed companies on the ChiNext Board are usually of emerging nature with smaller operating scale. Hence, they are subject to higher fluctuation in stock prices and liquidity and have higher risks and turnover ratios than companies listed on the Main Board of the SZSE ("Main Board").

Over-Valuation Risk

Stocks listed on the ChiNext Board may be overvalued and such exceptionally high valuation may not be sustainable. Stock price may be more susceptible to manipulation due to fewer circulating shares.

Differences in Regulations

The rules and regulations regarding companies listed on ChiNext Board are less stringent in terms of profitability and share capital than those in the Main Board.

Delisting Risk

It may be more common and faster for companies listed on the ChiNext Board to delist. This may have an adverse impact on the relevant Sub-Fund if the companies that it invests in are delisted.

Risk associated with Small-Capitalisation / Mid-Capitalisation Companies

The stocks of small-capitalisation / mid-capitalisation companies may have lower liquidity and their prices are more volatile to adverse economic developments than those of larger capitalisation companies in general.

Taxation Risk

Investments via the Stock Connect are subject to PRC's tax regime. The PRC State Administration of Taxation has reaffirmed the application of normal Chinese stamp duty and a 10% dividend withholding tax, while the value-added tax and income tax on capital gains are temporarily exempted for an unspecified period. The tax regime may change from time to time and the Sub-Funds are, thus, subject to such uncertainties in their PRC tax liabilities. For further details on PRC taxation, please refer to sub-section "PRC Taxation" under the section titled "Taxation".

RMB Currency Risk in relation to Stock Connect

China A-Shares are priced in RMB, and the relevant Sub-Funds will need to use RMB to trade and settle SSE/SZSE Securities. There may be associated trading costs involved in dealing with SSE/SZSE Securities. Mainland Chinese government controls future movements in exchange rates and currency conversion. The exchange rate floats against a basket of foreign currencies; therefore, such exchange rate could fluctuate widely against the USD, HKD or other foreign currencies in the future. In particular, any depreciation of RMB will decrease the value of any dividends and other proceeds an investor may receive from its investments. Further, investors should note that CNY may trade at a different rate compared to CNH. A Sub-Fund's investments may be exposed to both the CNY and the CNH, and the relevant Sub-Fund may consequently be exposed to greater exchange risks and/or higher costs of investment. The PRC government's policies on exchange control are subject to change, and the relevant Sub-Fund may be adversely affected.

For Sub-Funds which may invest into the Bond Markets of the PRC the following risks apply additionally:

Bond Connect

Bond Connect is an initiative launched in July 2017 for mutual bond market access between Hong Kong and Mainland China established by China Foreign Exchange Trade System & National Interbank Funding Centre ("CFETS"), China Central Depository & Clearing Co., Ltd, Shanghai Clearing House, and Hong Kong Exchanges and Clearing Limited and Central Moneymarkets Unit.

Bond Connect is governed by rules and regulations as promulgated by the Mainland Chinese authorities. Such rules and regulations may be amended from time to time and include (but are not limited to):

- (i) the "Interim Measures for the Administration of Mutual Bond Market Access between Mainland China and Hong Kong (Decree No.1 [2017])" issued by the People's Bank of China ("PBOC") on 21 June 2017,
- (ii) the "Guide on Registration of Overseas Investors for Northbound Trading in Bond Connect" issued by the Shanghai Head Office of PBOC on 22 June 2017; and
- (iii) any other applicable regulations promulgated by the relevant authorities.

Under the prevailing regulations in Mainland China, eligible foreign investors will be allowed to invest in the bonds circulated in the China Interbank Bond Market through the northbound trading of Bond Connect ("Northbound Trading Link"). There will be no investment quota for Northbound Trading Link. Under the Northbound Trading Link, eligible foreign investors are required to appoint the CFETS, or other institutions recognised by the PBOC as registration agents to apply for registration with the PBOC.

Pursuant to the prevailing regulations in Mainland China, an offshore custody agent recognised by the Hong Kong Monetary Authority (currently, the Central Moneymarkets Unit) shall open omnibus nominee accounts with the onshore custody agent recognised by the PBOC (currently, the China Central Depository & Clearing Co., Ltd and/or the Shanghai Clearing House). All debt securities traded by eligible foreign investors will be registered in the name of Central Moneymarkets Unit, which will hold such debt securities as a nominee owner.

Market volatility and potential lack of liquidity due to low trading volume of certain debt securities in the China Interbank Bond Market may result in prices of certain debt securities traded on such market fluctuating significantly. The Sub-Fund investing in such market is therefore subject to liquidity and volatility risks. The bid and offer spreads of the prices of such securities may be large, and the Sub-Fund may therefore incur significant trading and realisation costs and may even suffer losses when selling such investments.

To the extent that the Sub-Fund transacts in the China Interbank Bond Market, the Sub-Fund may also be exposed to risks associated with settlement procedures and default of counterparties. The counterparty which has entered into a transaction with the Sub-Fund may default in its obligation to settle the transaction by delivery of the relevant security or by payment for value.

For investments via Bond Connect, the relevant filings, registration with PBOC and account opening have to be carried out via an onshore settlement agent, offshore custody agent, registration agent or other third parties (as the case may be). As such, the respective Sub-Fund is subject to the risks of default or errors on the part of such third parties.

Investing in the China Interbank Bond Market via Bond Connect is also subject to regulatory risks. The relevant rules and regulations on these regimes are subject to change which may have potential retrospective effect. In the event that the relevant Mainland Chinese authorities suspend account opening or trading on the China Interbank Bond Market, the Sub-Fund's ability to invest in the China Interbank Bond Market will be adversely affected. In such event, the Sub-Fund's ability to achieve its investment objective will be negatively affected.

Trading through Bond Connect is performed through newly developed trading platforms and operational systems. There is no assurance that such systems will function properly or will continue to be adapted to changes and developments in the market. If the relevant systems fail to function properly, trading through Bond Connect may be disrupted. A Sub-Fund's ability to trade through Bond Connect (and hence to pursue its investment strategy) may therefore be adversely affected. In addition, where a Sub-Fund invests in the China Interbank Bond Market through Bond Connect, such Sub-Fund may be subject to risks of delays inherent in the order placing and/or settlement systems.

China Interbank Bond Market

Overview

Participation in CIBM by foreign institutional investors (where such is mentioned in the investment restrictions of the relevant Sub-Fund) via a foreign access regime (e.g., FII program, CIBM Initiative and/or Bond Connect) is governed by rules and regulations as promulgated by the Mainland Chinese authorities, i.e., the PBOC and the State Administration of Foreign Exchange ("SAFE"). Such rules and regulations may be amended from time to time and include (but are not limited to):

- (i) the "Announcement (2016) No 3" issued by the PBOC on 17 February 2016,
- (ii) the "Implementation Rules for Filing by Foreign Institutional Investors for Investment in Interbank Bond Markets" issued by the Shanghai Head Office of PBOC on 27 May 2016,
- (iii) the "Circular concerning the Foreign Institutional Investors' Investment in Interbank bond market in relation to foreign currency control" issued by SAFE on 27 May 2016, and
- (iv) any other applicable regulations promulgated by the relevant authorities.

Under the prevailing regulations in the PRC, foreign institutional investors who wish to invest directly in CIBM via CIBM Initiative may do so via an onshore settlement agent, who will be responsible for making the relevant filings and account opening with the relevant authorities. There is no quota limitation.

In terms of fund remittance and repatriation, foreign investors (such as the Company) may remit investment principal in RMB or foreign currency into the PRC for investing in the CIBM. An investor needs to file relevant information about its investments with the Shanghai Head Office of PBOC through the onshore settlement agent and an updated filing may be required if there is any significant change to the filed information. Where the Company repatriates funds out of the PRC, the ratio of RMB to foreign currency ("Currency Ratio") should generally match the original Currency Ratio when the investment principal was remitted into the PRC, with a maximum permissible deviation of 10%.

Taxation Risk

According to Circular 108, the foreign institutional investors are temporarily exempt from PRC CIT and VAT with respect to bond interest income derived in the PRC bond market for the period from 7 November 2018 to 6 November 2021. However, there is no guarantee that such temporary tax exemption will continue to apply, will not be repealed and re-imposed retrospective, or that no new tax regulations and practice in China specifically relating to the PRC bond market will not be promulgated in the future. For further details on PRC taxation, please refer to sub-section "PRC Taxation" under the section titled "Taxation".

Risks Associated with China Interbank Bond Market

Market volatility and potential lack of liquidity due to low trading volume of certain debt securities in the CIBM may result in prices of certain debt securities traded on such market fluctuating significantly. The Sub-Fund investing in such market is therefore subject to liquidity and volatility risks. The bid and offer spreads of the prices of such securities may be large, and a Sub-Fund may therefore incur significant trading and realisation costs and may even suffer losses when selling such investments.

To the extent that a Sub-Fund transacts in the CIBM, the Sub-Fund may also be exposed to risks associated with settlement procedures and default of counterparties. The counterparty which has entered into a transaction with the Sub-Fund may default in its obligation to settle the transaction by delivery of the relevant security or by payment for value.

Since the relevant filings and account opening for investment in the CIBM via CIBM Initiative have to be carried out via the onshore settlement agent, the relevant Sub-Fund is subject to the risks of default or errors on the part of the onshore settlement agent.

Investing in the CIBM via a foreign access regime (e.g., FII program, CIBM Initiative and/or Bond Connect) is also subject to regulatory risks. The relevant rules and regulations on investment in the CIBM is subject to change which may have potential retrospective effect. If the relevant Mainland Chinese authorities suspend account opening or trading on the CIBM, a Sub-Fund's ability to invest in the CIBM will be limited and, after exhausting other trading alternatives, the Sub-Fund may suffer substantial losses as a result.

Credit Rating Agency Risk

The credit appraisal system in the PRC and the rating methodologies employed in the PRC may be different from those employed in other markets. Credit ratings given by PRC rating agencies may therefore not be directly comparable with those given by other international rating agencies.

RMB Debt Securities Risk

Investors should be aware that the availability of RMB-denominated Debt Securities issued or distributed outside PRC is currently limited and therefore is more susceptible to volatility and illiquidity. The operation of the RMB-denominated Debt Securities markets as well as new issuances could be disrupted, causing a fall in the NAV of the Sub-Fund should there be any promulgation of new rules which limit or restrict the ability of issuers to raise RMB by way of bond issuances and/or reversal or suspension of the liberalization of the CNH market by the relevant regulators.

If there are insufficient RMB-denominated Debt Securities for a Sub-Fund to invest in, the Sub-Fund may hold a significant portion of assets in RMB deposit accounts and/or RMB-denominated certificates of deposit issued by financial institutions. These circumstances may have an adverse impact on the performance of such Sub-Fund.

For RMB-denominated Debt Securities issued, listed, or traded outside PRC (e.g., on the Central Moneymarkets Unit in Hong Kong), market depth may be limited, potentially resulting in reduced liquidity or even partial illiquidity of such securities. The Sub-Fund may suffer loss in trading such securities, in particular in circumstances where the Sub-Fund may have to liquidate such investments at a discount in order to meet redemption requests. The Sub-Fund may not be able to sell the securities at the time desired.

In addition, the bid and offer spread of the price of RMB-denominated Debt Securities may be large. Therefore, the Sub-Fund may incur significant trading and realisation costs and may suffer significant losses when selling such investments.

Investments in RMB-denominated Debt Securities are also subject to the general risks of investing in bonds, including, but not limited to interest-rate risks, creditworthiness risk, company specific risk, general market risk, risk of default and counterparty risk.

RMB-denominated Debt Securities are typically unsecured debt obligations and are not supported by any collateral. Investments in such securities will expose the relevant Sub-Fund to the credit/insolvency risk of its counterparties as an unsecured creditor. RMB-denominated Debt Securities may be unrated. In general, debt instruments that have a lower credit rating or that are unrated may be more susceptible to the credit risk of the issuer.

Investments in Debt Securities issued by companies or bodies established within PRC may be affected by PRC tax policies. Current tax laws and regulations may also be amended or revised at any point in time and without prior notice to investors. Such amendments and revisions may also take effect on a retrospective basis, with a potentially adverse impact on such investments.

Certain Sub-funds invest in the onshore Debt Securities which may be traded on the Shanghai or Shenzhen Stock Exchange or on the interbank bond markets. Investors should note that the securities markets in PRC generally and the onshore bond markets in particular are both at a developing stage and the market capitalisation and trading volume may be lower than those in more developed financial markets. Market volatility and potential lack of liquidity due to low trading volumes in PRC's debt markets may result in prices of securities traded on such markets fluctuating significantly and may result in substantial volatility in the Net Asset Value of the Sub-Fund. The bid and offer spreads of the prices of the Mainland Chinese Debt Securities may be large, so significant trading and realization costs may be incurred. The national regulatory and legal framework for capital markets and debt instruments in PRC are still developing when compared with those of developed countries. Currently, PRC entities are undergoing reform with the intention of increasing liquidity of debt instruments. However, the effects of any development or reform on the PRC debt markets remain to be seen. The PRC bond markets are also subject to regulatory risks.

Debt Securities may only be bought from, or sold to, the Sub-Fund from time to time where the relevant Debt Securities may be sold or purchased on the Shanghai Stock Exchange, the Shenzhen Stock Exchange or the CIBM, as appropriate. Given that the bond markets are considered volatile and unstable (with the risk of suspension of a particular stock or government intervention), the subscription and redemption of Sub-Fund's units may also be disrupted.

Commodities Markets Risk

Positions in commodity futures, precious metals or commodity markets ("Commodities") are subject to general market risk. The performance of Commodities depends on the general supply and demand of the respective goods, as well as the expected demand, output, extraction, and production. Therefore, the performance of Commodities can be especially volatile.

Certificate Investments will be exposed to Certificate Investments risks. Derivative-based investments are subject to the general risks associated with investment in derivatives. Investment in funds oriented towards Commodities is also subject to the specific risks of investing in target funds. With respect to index-based investments, the Index-based Investments Risk will apply.

In addition to the costs incurred in the acquisition and sale of a certificate, a derivative, or shares in funds oriented towards Commodities, additional costs may be incurred at the level of an index, a certificate, a derivative, or the above-mentioned funds, which could affect the value of the investment, possibly to a substantial extent.

Credit Long/Short Strategy Risk

Credit Long / Short strategies focuses on fixed income securities where most of the return is derived from corporate credit exposure and selection as opposed to the general term structure of interest rates. Strategies utilized by long/short credit include the purchase or short sale of stressed and distressed bonds, high-yield debt, and securities from recently reorganized firms. The objective of Credit Long / Short strategies is generally to seek exposure to credit sensitive securities by identifying improving and undervalued issuers for the long side and deteriorating or overvalued fixed income securities for the short side.

The strategy attempts to capitalize on inefficiencies in the marketplace while maintaining a lower degree of correlation to traditional asset classes as well as higher liquidity than a typical distressed debt investment.

A strategy that takes both long and short positions offers the potential for investors to take advantage of falling as well as rising markets and, subsequently, to manage market volatility more effectively compared with traditional long-only strategies. In addition, a long-short credit strategy typically performs when market volatility increases and when credit spreads widen by establishing downside protection. The success of a credit long/short strategy depends primarily on the selection of fixed income securities as well as on the degree of accuracy in forecasting the future performance of the credit markets. Depending on how the market does, the prices of the long and short positions could perform differently and losses in both positions could result. In addition, by investing in a long/short credit fund, an investor is principally exposed to interest rate, credit and default risks and, potentially, to currency exchange rate risk. The risks connected with the use of derivatives should also be noted.

Defaulted Securities / Distressed Debt Risk

In certain cases, a Sub-Fund may acquire securities issued from an issuer that has defaulted on their interest/coupon payments ("Defaulted/Distressed Debt Securities"). The purchase of these securities exposes the Sub-Fund to the specific risk of Issuer Default (see Issuer Default Risk). In addition, an insolvency administrator is usually appointed to manage the defaulted issuer on behalf of the issuer's directors. There is a high risk that the insolvency administrator realises the failed company's assets, pays the liquidation expenses and compensates the creditors as far as the issuer's remaining assets allow. This causes a long-lasting risk to the Sub-Fund that had acquired defaulted securities that these securities could potentially become completely worthless from an economic view. There is therefore a significant risk that the initial invest in the Defaulted/Distressed Debt could be lost entirely. If a security held becomes defaulted, the Sub-Fund may continue to hold the defaulted security until such time as the Investment Manager determines.

Event-Driven Strategies Risk

Event-driven investing is an investment strategy that seeks to exploit pricing inefficiencies that may occur before or after a corporate event, such as a bankruptcy, merger, acquisition, or spinoff. Event-driven strategies involve investment, long or short, in the equity and debt securities of corporations undergoing such significant change. Corporate events often provide managers with a tangible catalyst by which the manager may be able to realize the expected change in value in the underlying security. Profits may be generated by managers who correctly analyze the impact of the anticipated corporate event, predict the course of restructuring and take positions accordingly.

The primary risk of event-driven investing is individual transaction risk, should a planned corporate event not occur. If a deal is terminated, the target and acquiring companies' securities tend to revert to price levels prior to the transaction announcement, possibly erasing gains or causing losses.

The risks connected with the use of derivatives should also be noted.

Global Macro Strategies Risk

A global macro strategy employs a top-down investment approach and generally analyzes macroeconomic variables, such as a country's gross domestic products growth trends, inflation expectations, employment levels, and money supply, in order to assess the potential pricing impact a change in one or more of these variables would have on a region's equity, sovereign debt, commodity, and/or currency markets.

As such strategies tend to be uncorrelated to traditional asset classes, global macro funds tend to perform best in situations that would be unfavorable to those asset classes. These situations include the following. 1) Periods of sustained increased volatility in currencies, interest rates, commodities and equity markets. 2) Periods where markets are driven by overall macroeconomic themes rather than by individual bottom-up fundamental analysis. The reason global macro strategies work best in these environments is that they tend to trade in highly liquid markets, allowing them to quickly exploit opportunities as they arise or adjust portfolio risk exposures as the market environment changes. While global macro funds also invest in equities, the focus is on the impact of macroeconomic variables on the price of the equity rather than on the fundamental characteristics of a company. Generally global macro funds use derivatives on global equity indices to manage equity exposures but might construct a custom basket of single equities to manage a more specific risk. When markets are less volatile and showing overall strength, there are fewer chances for global macro managers to capitalize on short-term opportunities, so they tend not to perform as well in these periods.

The risks connected with the use of derivatives should also be noted.

Hedge Fund Risk

A Sub-Fund's investment in "hedge fund" indices and other hedge fund-related investments is regarded as "Alternative Investments".

It must be noted that a "hedge fund" index does not refer to funds that seek to hedge and neutralise investment risk, but rather to funds that normally pursue purely speculative investment objectives. Investors who invest directly or indirectly in hedge fund indices or in hedge funds themselves must be able to accept the financial risks of investing in such funds and the associated risk

of losing some or all of the invested capital. For investments related to a hedge fund index, losses at the level of a hedge fund belonging to such an index may have a negative impact.

In addition, to the investment risks generally associated with the investment policy and the assets of a hedge fund (e.g., Equities, bonds, high-yield investments, derivatives), performance risk may also be sharply increased. Hedge funds and their business activities are, generally, not subject to any governmental supervision or control for the protection of their investors and are not bound by investment restrictions or limits nor the principle of risk diversification. Assets of hedge funds are not held in separate custody by any institutions that specifically undertake to protect the investor; for this reason, there is an increased custodial and settlement default risk. In addition, currency risk, the risk of changes in underlying conditions and country and transfer risks may be of relevance.

Such hedge funds underlying an index, operate independently from one another which, on the one hand, may (but not necessarily) result in risk diversification and, on the other hand, may result in a balancing of positions while still incurring additional costs. Hedge funds may regularly take out loans for the joint account of investors or use corresponding derivatives to increase their level of investment – possibly even without restriction. While such practices increase the opportunities to increase overall returns, they are also subject to the risk of increased or total loss.

Hedge funds may also regularly make short sales, meaning the sale of assets received through securities lending, with an obligation to return them to a third party. If the prices of assets sold in this way subsequently fall, a hedge fund may possibly realise profits, after deduction of expenses; however, subsequent price increases in such assets will result in losses for the hedge fund.

The individual components of an index are generally valued using recognised methods for the assets contained in it. These valuations may initially only have been prepared based on unaudited interim reports. After an audit has been conducted, an adjustment may be made up or down. This could also change the value of an index in which the relevant hedge fund is included. As a result, the published value of the index may deviate from the actual value if there is a subsequent correction of the net asset values of the individual index components. This applies likewise to the valuation of hedge funds, however, if the position is not index-related. With respect to index-based investments, the Index-based Investments risks will apply.

In addition to the costs incurred in the acquisition and sale of a certificate, a derivative, or shares in a hedge fund, additional costs may be incurred at the level of a hedge fund index, a certificate, a derivative, or a hedge fund, which could affect the value of the investment, possibly to a substantial extent.

High-Yield Investments Risk

High-yield investments are Debt Securities that are either rated non-investment grade by a recognised rating agency or are not rated at all, but that would presumably receive a rating of non-investment grade if they were to be rated. In particular, such investments are normally associated with an increased degree of creditworthiness risk, risk of interest rate changes, general market risk, company-specific risk and liquidity risk than higher rated, lower yielding securities. Such increased risk may have an adverse impact on the Sub-Fund and/or the investors.

Leverage Risk

Certain Sub-Funds seek to provide leveraged returns by making use of derivatives such as swaps, options, and future-contracts to accomplish the Sub-Fund's investment objective. Depending on the purpose of derivatives used, the use of leverage (based on Derivatives) can cause leveraged Sub-Funds to be more volatile and subject to higher price movements than the same portfolio would have without any derivatives. The use of leverage may result in losses which are caused by leveraged positions. At the same time, the combined investments (including all derivative and non-derivative positions) will result in an overall (economic) exposure that is in line with the Sub-Fund's investment objective. The applied risk management approach for each Sub-Fund and a Sub-Fund's expected level of leverage of derivatives is disclosed in Appendix 4.

Market Neutral Long/Short Equity Strategy Risk

A market neutral long/short equity strategy involves entering into long positions on equity-oriented securities while simultaneously reducing, or entirely eliminating, market risk using opposing short positions. This is normally done by opening long and short positions to an approximately equal extent.

The success of a market neutral long/short equity strategy depends primarily on the selection of equity-oriented securities as well as on the degree of accuracy in forecasting the future performance of equity markets. If the prices of securities held as long positions in the portfolio rise, the Sub-Fund participates in this performance, while it takes a loss if these prices fall. Conversely, if the prices of securities held as short positions in the portfolio fall, the Sub-Fund participates in this performance, while it takes a loss if these prices rise. The risk of loss is essentially unlimited.

The use of a pure market neutral long/short equity strategy is intended to limit the overall potential for losses on investments made using a market neutral long/short equity strategy. However, depending on how the market performs, the prices of the long and short positions could perform differently and losses in both positions could result. If one of the two positions is larger than the other, the larger position is subject to the risk described in the previous paragraph without the potential of the risk being mitigated by an offsetting position.

Private Equity Risk

While assets that are issued by companies active in the area of private equity may be listed on an exchange, the investments made by such companies in private equity companies ("PE Investments") are not regularly traded on any exchange. Such companies may acquire several different assets by investing in PE Investments, include shareholders' equity, hybrid equity or debt. The capital made available may be subordinate to other creditors of the relevant PE Investment. PE Investments may be made for venture capital, buy-out investments or special situation investment purposes.

PE Investments are normally long-term, not traded on an exchange, illiquid and only fungible to a limited extent. In addition, the process of investing in PE Investments may itself be subject to technical difficulties and risks. PE Investments typically have risks that are greater in scope than those of conventional investments in listed companies, which may correspondingly impact assets, income, liquidity situation and value of the companies operating in the area of private equity. For example, private equity companies may often only exist for a short period of time or find themselves in a restructuring phase or a crisis, have rather limited market experience and penetration, offer new products not yet established on the market and have a rather tight financial position, uncertain planning, and substandard levels of organisation. The accounting, auditing and financial reporting standards and the advertising used by a private equity company may be substantially below those of conventional, exchange-traded investments. Private equity companies are often subject to little or no governmental supervision.

In addition to the costs incurred in the acquisition and sale of a certificate, a derivative, or shares in funds oriented towards companies that essentially operate in the private equity sector, additional costs may be incurred at the level of an index, a certificate, a derivative or the above-mentioned funds, which could affect the value of the investment, possibly to a substantial extent.

Property-Related Assets Risk

The Sub-Fund's investments in the real estate industry may be subject to risks of fluctuations in the value and the rental income received in respect of the underlying property. This also applies when investments are made through funds, property companies or other property equity market-related products (in particular, REITs). The following risks should be emphasized:

The underlying REITs which the Sub-Fund may invest in may not necessarily be authorized by the SFC and the dividend or pay out policy of the Sub-Fund is not representative of the dividend or pay out policy of the underlying REITs.

In addition to the risks of any changes in the underlying general economic conditions, there are special risks associated with property ownership, such as vacancies, delinquent/defaulted rental payments or charges for use that may depend, among other things, on the quality of the location or the creditworthiness of the tenant/debtor. Leasehold rights may revert ahead of schedule with the result that another use must be found for the property than was originally intended, and such other use may not have the same prospects. This applies analogously for reversion after the expiration of the contract or, if applicable, in similar situations with rights granted to a third party. The attachment of leasehold rights or other rights to a property may restrict its saleability. Actual returns on an investment may deviate from previous calculations. There is also the risk of restricted ability to use a property for other purposes.

The condition of the building or its structure may also require necessary maintenance and restoration expenses that are not always predictable. Buildings may have construction deficiencies and risks from contaminated sites cannot be excluded. There may also be cases of uninsured damages. Properties, especially in metropolitan areas, may be subject to war or terror risks. A property may decrease in economic value if the property market in the affected area is affected over the long term, and it becomes difficult or impossible to find tenants.

In the development of the project, there may also be risks such as changes in construction planning and delays in issuing building permits or other necessary official permissions or increases in construction costs. The success of the initial letting is particularly dependent on the demand situation at the time the construction is completed, which will be later.

In the case of investing abroad, additional risks to be considered are those that result from the features of the specific property (e.g., different legal and tax systems, differing interpretations of double taxation agreements and, if applicable, changes in exchange rates). Other risks associated with foreign investments to be considered are the increased management risk, any technical difficulties, including transfer risks regarding current income or proceeds of sales, as well as currency risks.

For investments in property companies, the risks to be considered are those that result from the form of the company, risks in connection with the possible default of partners and risks of changes to the tax and corporate law framework. This is especially true if the property companies are headquartered in a foreign country. Moreover, if interests in property companies are acquired, they may have obligations that are difficult to recognise and there may not be a liquid secondary market for an intended disposal of the interest. Changes in the value of properties have an increased effect on equity when outside financing is used. This affects the profit for the investor when prices rise or fall, then when the project is completely self-financed. When properties are sold, the purchaser or other third parties may have guarantee claims.

In addition to the costs incurred in the acquisition and sale of a certificate, a derivative, or shares in property funds or in funds oriented towards REITs, additional costs may be incurred at the level of an index, a certificate, a derivative, or the above-mentioned funds, which could affect the value of the investment, possibly to a substantial extent.

Risks relating to Water Sector

A Sub-Fund may be more susceptible to different water-related factors. Companies invested in markets with regulated water tariffs may suffer from decreasing water tariffs, which would lower the revenues and the returns of listed water operators. Moreover, during budget process, water-related projects may be given a lower priority and be delayed. Political forces may put priorities on projects in different sectors such as healthcare, infrastructure, and education. The growth outlook of water-related companies may be reduced. A Sub-Fund's value may be adversely affected.

Sector and Theme Fund Risk

Sector and theme funds have a limited investment universe which results in limited risk diversification compared to broadly investing funds. The more specific the respective sector and/or theme is the more limited the investment universe and the more limited the risk diversification might be. A limited risk diversification can increase the impact of the development of individual securities acquired for the respective fund. In addition, sector and theme funds may acquire Equities of companies which are also related to other sectors and/or themes in case of companies being active in various sectors and/or themes. This may include Equities of companies which are – at the time of acquisition – only related to a minor part to the respective sector and/or theme if such companies - pursuant to the portfolio manager’s discretionary assessment – will likely materially increase the importance of such segment of their business activities. This may result in deviations of the performance of the respective fund compared to the performance of financial indices reflecting the respective sector and/or theme.

Sustainable Strategy Investment Risk

Sub-Funds which follow a specific Sustainable Investment Strategy as mentioned in Annex 1, Part B (the “Sustainable Investment Strategy”) apply either minimum exclusion criteria and/or certain (internal/external) rating assessments which may adversely affect a Sub-Fund’s investment performance. A Sub-Fund’s investment performance might be impacted and/or influenced by a Sustainability Risk since the execution of a Sustainable Investment Strategy may result in foregoing opportunities to buy certain securities when it might otherwise be advantageous to do so, and/or selling securities due to their characteristics when it might be disadvantageous to do so. Sub-Funds which apply a Sustainable Investment Strategy may use one or more different third-party research data providers and/or internal analyses, and the way in which different Sub-Funds will apply certain criteria may vary. In assessing the eligibility of an issuer based on research, there is a dependence upon information and data from third party research data providers and internal analyses, which may be subjective, incomplete, inaccurate, or unavailable. As a result, there is a risk to incorrectly or subjectively assess a security or issuer. There is also a risk that a Sub-Fund’s Investment Manager may not apply the relevant criteria resulting out of the research correctly or that a Sub-Fund which follows a Sustainable Investment Strategy could have indirect exposure to issuers who do not meet the relevant criteria of the respective Sustainable Investment Strategy. There is a lack of standardized taxonomy of Sustainable Investments.

In addition, Sub-Funds which follow a specific Sustainable Investment Strategy focus on Sustainable Investments and have a limited / reduced investment universe which results in limited risk diversification compared to broadly investing funds. The more specific the respective sector and/or theme a Sub-Fund intends to invest in is (e.g., SDGs or other comparable societal goals) the more limited the Sub-Fund’s investment universe and the more limited the risk diversification might be. A limited risk diversification can increase the impact of the development of individual securities acquired for the respective Sub-Fund. The Sub-Fund is likely to be more volatile than a fund that has a more diversified investment strategy. It may be more susceptible to fluctuations in value resulting from the impact of adverse conditions on these investments. In addition, Sub-Funds which apply a specific Sustainable Investment Strategy may – subject to the respective Strategy - acquire Equities of companies which are also related to other sectors and/or themes in case of companies being active in various sectors and/or themes. This may include Equities of companies which are – at the time of acquisition – only related to a minor part to the respective SDGs or to the respective comparable societal goal if such companies - pursuant to the portfolio manager’s discretionary assessment – will likely materially increase the importance of such segment of their business activities. This may result in deviations of the performance of the respective fund compared to the performance of financial indices reflecting the respective SDG or the respective comparable societal goal. This may have an adverse impact on the performance of the Sub-Fund and consequently adversely affect an investor’s investment in the Sub-Fund.

The securities held by the Sub-Fund may be subject to style drift which no longer meet the Sub-Fund’s investment criteria after the Sub-Fund’s investments. The Management Company or Investment Manager might need to dispose of such securities when it might be disadvantageous to do so. This may lead to a fall in the Sub-Fund’s Net Asset Value.

Volatility Strategies Risk

Volatility strategies in an investment strategy that seeks to exploit pricing inefficiencies that may occur as a consequence of realized volatility compared to presumed volatility as reflected in current market prices of respective derivatives such as variance swaps. Volatility describes the variation of a trading price series over time. The higher the differences of low and high market prices of an asset are, the more volatile such asset is.

A variance swap results in a financial settlement between the parties at the end of the swap period. The amount of this settlement is the swap’s nominal value multiplied by the difference between the annualised realised variance and a reference value fixed for the variance at the start of the swap period (the strike variance, which generally corresponds to the expected variance for the respective swap period). The value of a variance swap does not depend 1:1 on the absolute performance of the underlying to which it refers; instead, it depends on the change in the annualised realised variance of the respective underlying in the respective swap period. For this reason, the value of a variance swap may even rise when the value of its underlying is dropping, or it may fall when the value of its underlying security is rising. The success of the investment strategy therefore depends particularly on the extent to which, within the quantitative approach, the change in the annualised realised variance of the respective underlying can be accurately forecast for a corresponding swap period.

An option-based investment strategy is a particular form of a volatility strategy. It utilizes equity option spreads, typically buying and selling put options and call options including, without any limitation, on global equity indices, global equity index futures, global equity market related volatility indices, global equity market related volatility futures, and exchange traded funds. The objective of the option spreads is to create option based “profit zones” that upon expiration of the options will lead to a positive return for the strategy if the level of the underlying index (or other instrument) ends up within such profit zone. However, if the level of the underlying index (or other instrument) ends up outside such profit zone it will result in a loss for the fund.

The risks connected with the use of derivatives should also be noted.

3. Sub-Fund-Specific Risk Factors on an Individual Basis

Sub-Fund Name	China Investment Risk	Commodities Markets Risk	Credit Long/Short Strategy Risk	Defaulted Securities/Distressed Debt Risk	Event-Driven Strategies Risk	Global Macro Strategies Risk	Hedge Fund Risk	High-Yield Investments Risk	Leverage Risk	Market Neutral Long/Short Equity Strategy Risk	Private Equity Risk	Property-Related Assets Risk	Risks relating to Water Sector	Sector and Theme Fund Risk	Sustainable Strategy Investment Risk	Volatility Strategies Risk
Allianz ActiveInvest Balanced	-	✓	-	-	✓	✓	✓	✓	-	✓	-	-	-	-	✓	✓
Allianz ActiveInvest Defensive	-	✓	-	-	✓	✓	✓	✓	-	✓	-	-	-	-	✓	✓
Allianz ActiveInvest Dynamic	-	✓	-	-	✓	✓	✓	✓	-	✓	-	-	-	-	✓	✓
Allianz Advanced Fixed Income Euro	-	-	-	-	-	-	-	✓	-	-	-	-	-	-	✓	-
Allianz Advanced Fixed Income Global	✓	-	-	-	-	-	-	✓	-	-	-	-	-	-	✓	-
Allianz Advanced Fixed Income Global Aggregate	✓	-	-	-	-	-	-	✓	-	-	-	-	-	-	✓	-
Allianz Advanced Fixed Income Short Duration	-	-	-	-	-	-	-	✓	-	-	-	-	-	-	✓	-
Allianz All China Equity	✓	-	-	-	-	-	-	-	-	-	-	-	-	-	✓	-
Allianz Alternative Investment Strategies	-	-	✓	-	✓	✓	-	✓	-	✓	-	-	-	-	-	✓
Allianz American Income	✓	-	-	-	-	-	-	✓	-	-	-	-	-	-	-	-
Allianz Asian Multi Income Plus	✓	-	-	-	-	-	-	✓	-	-	-	-	-	-	-	-
Allianz Asian Small Cap Equity	✓	-	-	-	-	-	-	✓	-	-	-	-	-	-	-	-
Allianz Best Ideas 2025	✓	✓	✓	-	✓	✓	✓	✓	✓	✓	✓	✓	-	-	-	✓
Allianz Best of Managers	-	✓	-	-	✓	✓	✓	✓	-	✓	-	-	-	-	-	✓
Allianz Best Styles Euroland Equity	-	-	-	-	-	-	-	-	-	-	-	✓	-	-	-	-
Allianz Best Styles Europe Equity	-	-	-	-	-	-	-	-	-	-	-	✓	-	-	-	-
Allianz Best Styles Europe Equity SRI	-	-	-	-	-	-	-	-	-	-	-	✓	-	-	✓	-
Allianz Best Styles Global AC Equity	✓	-	-	-	-	-	-	-	-	-	-	✓	-	-	-	-
Allianz Best Styles Global Equity	-	-	-	-	-	-	-	-	-	-	-	✓	-	-	-	-
Allianz Best Styles Global Equity SRI	-	-	-	-	-	-	-	-	-	-	-	✓	-	-	✓	-
Allianz Best Styles Pacific Equity	-	-	-	-	-	-	-	-	-	-	-	✓	-	-	-	-
Allianz Best Styles US Equity	-	-	-	-	-	-	-	-	-	-	-	✓	-	-	✓	-
Allianz Better World Defensive	✓	-	-	-	-	-	-	✓	-	-	-	-	✓	✓	✓	-
Allianz Better World Dynamic	✓	-	-	-	-	-	-	✓	-	-	-	-	✓	✓	✓	-
Allianz Better World Moderate	✓	-	-	-	-	-	-	✓	-	-	-	-	✓	✓	✓	-
Allianz Blockchain Opportunities	✓	-	-	-	-	-	-	-	-	-	-	-	-	✓	-	-
Allianz Capital Plus	-	-	-	-	-	-	-	✓	-	-	-	-	-	-	✓	-
Allianz Capital Plus Global	✓	-	-	-	-	-	-	✓	-	-	-	-	-	-	✓	-
Allianz China A Opportunities	✓	-	-	-	-	-	-	-	-	-	-	-	-	-	✓	-
Allianz China A-Shares	✓	-	-	-	-	-	-	-	-	-	-	-	-	-	✓	-
Allianz China Equity	✓	-	-	-	-	-	-	-	-	-	-	-	-	-	✓	-
Allianz China Future Technologies	✓	-	-	-	-	-	-	-	-	-	-	-	-	✓	-	-

Sub-Fund Name	China Investment Risk	Commodities Markets Risk	Credit Long/Short Strategy Risk	Defaulted Securities/Distressed Debt Risk	Event-Driven Strategies Risk	Global Macro Strategies Risk	Hedge Fund Risk	High-Yield Investments Risk	Leverage Risk	Market Neutral Long/Short Equity Strategy Risk	Private Equity Risk	Property-Related Assets Risk	Risks relating to Water Sector	Sector and Theme Fund Risk	Sustainable Strategy Investment Risk	Volatility Strategies Risk
Allianz China Healthy Living	✓	-	-	-	-	-	-	-	-	-	-	-	-	✓	-	-
Allianz China Multi Income Plus	✓	-	-	✓	-	-	-	✓	-	-	-	-	-	-	-	-
Allianz China Strategic Bond	✓	-	-	-	-	-	-	✓	-	-	-	-	-	-	-	-
Allianz China Thematica	✓	-	-	-	-	-	-	-	-	-	-	-	-	✓	✓	-
Allianz Clean Planet	✓	-	-	-	-	-	-	-	-	-	-	-	✓	✓	✓	-
Allianz Climate Transition	-	-	-	-	-	-	-	-	-	-	-	-	-	✓	✓	-
Allianz Convertible Bond	-	-	-	✓	-	-	-	✓	-	-	-	-	-	-	✓	-
Allianz Coupon Select Plus V	-	✓	-	-	✓	✓	✓	✓	-	✓	-	-	-	-	-	✓
Allianz Coupon Select Plus VI	-	✓	-	-	✓	✓	✓	✓	-	✓	-	-	-	-	-	✓
Allianz Credit Opportunities	✓	-	✓	-	-	-	-	✓	-	-	-	-	-	-	-	-
Allianz Credit Opportunities Plus	✓	-	✓	-	-	-	-	✓	✓	-	-	-	-	-	-	-
Allianz Cyber Security	✓	-	-	-	-	-	-	-	-	-	-	-	-	✓	✓	-
Allianz Dynamic Allocation Plus Equity	✓	-	✓	-	-	✓	✓	✓	✓	-	✓	-	-	-	-	✓
Allianz Dynamic Asian High Yield Bond	✓	-	-	✓	-	-	-	✓	-	-	-	-	-	-	-	-
Allianz Dynamic Commodities	-	✓	-	-	-	-	-	✓	✓	-	-	-	-	-	-	-
Allianz Dynamic Multi Asset Strategy SRI 15	-	✓	-	-	✓	✓	✓	✓	-	✓	✓	✓	-	-	✓	✓
Allianz Dynamic Multi Asset Strategy SRI 50	-	✓	-	-	✓	✓	✓	✓	-	✓	✓	✓	-	-	✓	✓
Allianz Dynamic Multi Asset Strategy SRI 75	-	✓	-	-	✓	✓	✓	✓	-	✓	✓	✓	-	-	✓	✓
Allianz Emerging Asia Equity	✓	-	-	-	-	-	-	-	-	-	-	-	-	-	-	-
Allianz Emerging Europe Equity	-	-	-	-	-	-	-	-	-	-	-	-	-	-	-	-
Allianz Emerging Markets Equity	✓	-	-	-	-	-	-	-	-	-	-	✓	-	-	-	-
Allianz Emerging Markets Equity Opportunities	✓	-	-	-	-	-	-	-	-	-	-	-	-	-	-	-
Allianz Emerging Markets Equity SRI	✓	-	-	-	-	-	-	-	-	-	-	✓	-	-	✓	-
Allianz Emerging Markets Multi Asset Income	✓	-	-	-	-	-	-	✓	-	-	-	✓	-	-	-	-
Allianz Emerging Markets Select Bond	✓	-	-	✓	-	-	-	✓	✓	-	-	-	-	-	-	-
Allianz Emerging Markets Short Duration Bond	✓	-	-	-	-	-	-	✓	✓	-	-	-	-	-	-	-
Allianz Emerging Markets Sovereign Bond	✓	-	-	✓	-	-	-	✓	-	-	-	-	-	-	-	-
Allianz Emerging Markets SRI Bond	✓	-	-	-	-	-	-	✓	-	-	-	-	-	-	✓	-
Allianz Emerging Markets SRI Corporate Bond	✓	-	-	-	-	-	-	✓	-	-	-	-	-	-	✓	-
Allianz Enhanced All China Equity	✓	-	-	-	-	-	-	-	-	-	-	-	-	-	-	-
Allianz Enhanced Short Term Euro	-	-	-	-	-	-	-	-	-	-	-	-	-	-	✓	-
Allianz Euro Balanced	-	-	-	-	-	-	-	-	-	-	-	✓	-	-	✓	-

Sub-Fund Name	China Investment Risk	Commodities Markets Risk	Credit Long/Short Strategy Risk	Defaulted Securities/Distressed Debt Risk	Event-Driven Strategies Risk	Global Macro Strategies Risk	Hedge Fund Risk	High-Yield Investments Risk	Leverage Risk	Market Neutral Long/Short Equity Strategy Risk	Private Equity Risk	Property-Related Assets Risk	Risks relating to Water Sector	Sector and Theme Fund Risk	Sustainable Strategy Investment Risk	Volatility Strategies Risk
Allianz Euro Bond	-	-	-	-	-	-	-	✓	✓	-	-	-	-	-	✓	-
Allianz Euro Bond Short Term 1-3 Plus	-	-	-	-	-	-	-	✓	-	-	-	-	-	-	✓	-
Allianz Euro Credit SRI	-	-	-	-	-	-	-	✓	-	-	-	-	-	-	✓	-
Allianz Euro Government Bond	-	-	-	-	-	-	-	-	-	-	-	-	-	-	✓	-
Allianz Euro High Yield Bond	-	-	-	-	-	-	-	✓	-	-	-	-	-	-	✓	-
Allianz Euro High Yield Defensive	-	-	-	-	-	-	-	✓	-	-	-	-	-	-	✓	-
Allianz Euro Inflation-linked Bond	-	-	-	-	-	-	-	-	-	-	-	-	-	-	✓	-
Allianz Euroland Equity Growth	-	-	-	-	-	-	-	-	-	-	-	-	-	-	✓	-
Allianz Europe Equity Growth	-	-	-	-	-	-	-	-	-	-	-	-	-	-	✓	-
Allianz Europe Equity Growth Select	-	-	-	-	-	-	-	-	-	-	-	-	-	-	✓	-
Allianz Europe Equity powered by Artificial Intelligence	-	-	-	-	-	-	-	-	-	-	-	✓	-	-	-	-
Allianz Europe Equity SRI	-	-	-	-	-	-	-	-	-	-	-	-	-	-	✓	-
Allianz Europe Equity Value	-	-	-	-	-	-	-	-	-	-	-	✓	-	-	✓	-
Allianz Europe Income and Growth	✓	-	✓	-	-	-	-	✓	-	-	-	✓	-	-	-	-
Allianz Europe Mid Cap Equity	-	-	-	-	-	-	-	-	-	-	-	✓	-	-	✓	-
Allianz Europe Small and Micro Cap Equity	-	-	-	-	-	-	-	-	-	-	-	-	-	-	✓	-
Allianz Europe Small Cap Equity	-	-	-	-	-	-	-	-	-	-	-	✓	-	-	✓	-
Allianz European Bond RC	-	-	-	-	-	-	-	✓	✓	-	-	-	-	-	-	-
Allianz European Equity Dividend	-	-	-	-	-	-	-	-	-	-	-	✓	-	-	✓	-
Allianz Fixed Income Macro	✓	-	✓	-	-	✓	-	✓	✓	-	-	-	-	-	-	-
Allianz Flexi Asia Bond	✓	-	-	✓	-	-	-	✓	-	-	-	-	-	-	✓	-
Allianz Floating Rate Notes Plus	-	-	-	-	-	-	-	-	-	-	-	-	-	-	✓	-
Allianz Food Security	✓	-	-	-	-	-	-	-	-	-	-	-	✓	✓	✓	-
Allianz GEM Equity High Dividend	✓	-	-	-	-	-	-	✓	-	-	-	-	-	-	-	-
Allianz German Equity	-	-	-	-	-	-	-	-	-	-	-	-	-	-	✓	-
Allianz German Small and Micro Cap	-	-	-	-	-	-	-	-	-	-	-	✓	-	-	-	-
Allianz Global Aggregate Bond	✓	-	-	-	-	-	-	✓	-	-	-	-	-	-	-	-
Allianz Global Artificial Intelligence	-	-	-	-	-	-	-	-	-	-	-	-	-	✓	✓	-
Allianz Global Capital Plus	✓	-	-	-	-	-	-	✓	-	-	-	-	-	-	✓	-
Allianz Global Credit SRI	✓	-	-	-	-	-	-	✓	-	-	-	-	-	-	✓	-
Allianz Global Diversified Dividend	-	-	-	-	-	-	-	-	-	-	-	✓	-	-	✓	-
Allianz Global Dividend	✓	-	-	-	-	-	-	-	-	-	-	-	-	-	-	-
Allianz Global Dynamic Multi Asset Income	-	-	-	-	-	-	-	✓	-	-	-	✓	-	-	-	-

Sub-Fund Name	China Investment Risk	Commodities Markets Risk	Credit Long/Short Strategy Risk	Defaulted Securities/Distressed Debt Risk	Event-Driven Strategies Risk	Global Macro Strategies Risk	Hedge Fund Risk	High-Yield Investments Risk	Leverage Risk	Market Neutral Long/Short Equity Strategy Risk	Private Equity Risk	Property-Related Assets Risk	Risks relating to Water Sector	Sector and Theme Fund Risk	Sustainable Strategy Investment Risk	Volatility Strategies Risk
Allianz Global Emerging Markets Equity Dividend	✓	-	-	-	-	-	-	-	-	-	-	-	-	-	-	-
Allianz Global Equity Growth	✓	-	-	-	-	-	-	-	-	-	-	-	-	-	✓	-
Allianz Global Equity Insights	✓	-	-	-	-	-	-	-	-	-	-	-	-	-	✓	-
Allianz Global Equity powered by Artificial Intelligence	-	-	-	-	-	-	-	-	-	-	-	✓	-	-	-	-
Allianz Global Equity Unconstrained	✓	-	-	-	-	-	-	-	-	-	-	-	-	-	✓	-
Allianz Global Floating Rate Notes Plus	-	-	-	-	-	-	-	✓	-	-	-	-	-	-	✓	-
Allianz Global Government Bond	✓	-	-	-	-	-	-	✓	-	-	-	-	-	-	-	-
Allianz Global High Yield	-	-	-	✓	-	-	-	✓	-	-	-	-	-	-	✓	-
Allianz Global Hi-Tech Growth	-	-	-	-	-	-	-	-	-	-	-	-	-	✓	✓	-
Allianz Global Income	✓	-	-	✓	-	-	-	✓	-	-	-	-	-	-	-	-
Allianz Global Inflation-Linked Bond	-	-	-	-	-	-	-	✓	✓	-	-	-	-	-	✓	-
Allianz Global Intelligent Cities Income	✓	-	-	✓	-	-	-	✓	-	-	-	-	-	✓	✓	-
Allianz Global Metals and Mining	✓	-	-	-	-	-	-	-	-	-	-	-	-	✓	-	-
Allianz Global Multi-Asset Credit	-	-	-	✓	-	-	-	✓	-	-	-	-	-	-	✓	-
Allianz Global Multi-Asset Credit SRI	-	-	-	✓	-	-	-	✓	-	-	-	-	-	-	✓	-
Allianz Global Multi Asset Sustainability Balanced	✓	-	-	-	-	-	-	✓	-	-	-	-	-	-	✓	-
Allianz Global Multi Asset Sustainability Conservative	✓	-	-	-	-	-	-	✓	-	-	-	-	-	-	✓	-
Allianz Global Multi Asset Sustainability Growth	✓	-	-	-	-	-	-	✓	-	-	-	-	-	-	✓	-
Allianz Global Opportunistic Bond	✓	✓	-	-	-	-	-	✓	✓	-	-	-	-	-	-	-
Allianz Global Small Cap Equity	✓	-	-	-	-	-	-	✓	-	-	-	✓	-	-	-	-
Allianz Global Sustainability	✓	-	-	-	-	-	-	-	-	-	-	-	-	✓	✓	-
Allianz Global Water	✓	-	-	-	-	-	-	-	-	-	-	-	✓	✓	✓	-
Allianz Green Bond	-	-	-	-	-	-	-	✓	-	-	-	-	-	-	✓	-
Allianz Green Future	-	-	-	-	-	-	-	✓	-	-	-	-	✓	✓	✓	-
Allianz Green Transition Bond	✓	-	-	-	-	-	-	✓	-	-	-	-	-	-	✓	-
Allianz High Dividend Asia Pacific Equity	✓	-	-	-	-	-	-	-	-	-	-	-	-	-	✓	-
Allianz HKD Income	✓	-	-	-	-	-	-	✓	-	-	-	-	-	-	-	-
Allianz Hong Kong Equity	✓	-	-	-	-	-	-	-	-	-	-	-	-	-	-	-
Allianz Income and Growth	✓	-	-	✓	-	-	-	✓	-	-	-	-	-	-	-	-
Allianz India Equity	-	-	-	-	-	-	-	-	-	-	-	-	-	-	-	-
Allianz Indonesia Equity	-	-	-	-	-	-	-	-	-	-	-	-	-	-	-	-
Allianz Japan Equity	-	-	-	-	-	-	-	-	-	-	-	-	-	-	✓	-

Sub-Fund Name	China Investment Risk	Commodities Markets Risk	Credit Long/Short Strategy Risk	Defaulted Securities/Distressed Debt Risk	Event-Driven Strategies Risk	Global Macro Strategies Risk	Hedge Fund Risk	High-Yield Investments Risk	Leverage Risk	Market Neutral Long/Short Equity Strategy Risk	Private Equity Risk	Property-Related Assets Risk	Risks relating to Water Sector	Sector and Theme Fund Risk	Sustainable Strategy Investment Risk	Volatility Strategies Risk
Allianz Japan Smaller Companies Equity	-	-	-	-	-	-	-	-	-	-	-	-	-	-	-	-
Allianz Laufzeitfonds	-	-	-	-	-	-	-	✓	-	-	-	-	-	-	✓	-
Allianz Little Dragons	✓	-	-	-	-	-	-	-	-	-	-	-	-	-	-	-
Allianz Metaverse	✓	-	-	-	-	-	-	-	-	-	-	-	-	✓	-	-
Allianz Multi Asset Long / Short	-	✓	✓	-	-	✓	✓	✓	✓	-	✓	✓	-	-	-	✓
Allianz Multi Asset Opportunities	-	✓	✓	-	-	✓	✓	✓	✓	-	✓	✓	-	-	-	✓
Allianz Multi Asset Risk Premia	-	✓	✓	-	-	✓	✓	✓	✓	-	✓	✓	-	-	-	✓
Allianz Oriental Income	✓	-	-	-	-	-	-	-	-	-	-	-	-	-	-	-
Allianz Pet and Animal Wellbeing	✓	-	-	-	-	-	-	-	-	-	-	-	-	✓	✓	-
Allianz Positive Change	✓	-	-	-	-	-	-	-	-	-	-	-	✓	✓	✓	-
Allianz Premium Champions	-	-	-	-	-	-	-	-	-	-	-	-	-	✓	-	-
Allianz Renminbi Fixed Income	✓	-	-	-	-	-	-	✓	-	-	-	-	-	-	-	-
Allianz SDG Euro Credit	-	-	-	-	-	-	-	-	-	-	-	-	-	-	✓	-
Allianz SDG Global Equity	-	-	-	-	-	-	-	-	-	-	-	✓	-	-	✓	-
Allianz Select Income and Growth	✓	-	-	-	-	-	-	✓	-	-	-	-	-	-	-	-
Allianz Selection Alternative	✓	-	✓	-	✓	✓	✓	✓	-	✓	✓	✓	-	-	-	✓
Allianz Selection Fixed Income	✓	-	-	-	-	-	-	✓	-	-	✓	✓	-	-	-	-
Allianz Selection Small and Mid Cap Equity	-	-	-	-	-	-	-	✓	-	-	-	-	-	-	-	-
Allianz Selective Global High Income	-	-	-	-	-	-	-	✓	-	-	-	-	-	-	✓	-
Allianz SGD Income	✓	-	-	-	-	-	-	✓	-	-	-	-	-	-	-	-
Allianz Short Duration Global Bond SRI	-	-	-	-	-	-	-	-	-	-	-	-	-	-	✓	-
Allianz Smart Energy	✓	-	-	-	-	-	-	-	-	-	-	-	-	-	✓	-
Allianz Social Conviction Equity	-	-	-	-	-	-	-	-	-	-	-	-	-	-	✓	-
Allianz Strategic Bond	✓	-	✓	-	-	✓	-	✓	✓	-	-	-	-	-	-	✓
Allianz Strategy Select 30	-	-	-	-	-	-	-	-	-	-	-	-	-	-	-	-
Allianz Strategy Select 50	-	-	-	-	-	-	-	-	-	-	-	-	-	-	-	-
Allianz Strategy Select 75	-	-	-	-	-	-	-	-	-	-	-	-	-	-	-	-
Allianz Strategy4Life 30	-	-	-	-	-	-	-	-	-	-	-	-	-	-	✓	-
Allianz Strategy4Life 50	-	-	-	-	-	-	-	-	-	-	-	-	-	-	✓	-
Allianz Strategy4Life 75	-	-	-	-	-	-	-	-	-	-	-	-	-	-	✓	-
Allianz Strategy4Life Europe 40	-	-	-	-	-	-	-	-	-	-	-	-	-	-	✓	-
Allianz Sustainable Health Evolution	✓	-	-	-	-	-	-	-	-	-	-	-	✓	✓	✓	-
Allianz Sustainable Multi Asset 75	-	✓	-	-	✓	✓	✓	✓	-	✓	✓	✓	✓	✓	✓	✓

Sub-Fund Name	China Investment Risk	Commodities Markets Risk	Credit Long/Short Strategy Risk	Defaulted Securities/Distressed Debt Risk	Event-Driven Strategies Risk	Global Macro Strategies Risk	Hedge Fund Risk	High-Yield Investments Risk	Leverage Risk	Market Neutral Long/Short Equity Strategy Risk	Private Equity Risk	Property-Related Assets Risk	Risks relating to Water Sector	Sector and Theme Fund Risk	Sustainable Strategy Investment Risk	Volatility Strategies Risk
Allianz Systematic Enhanced US Equity SRI	-	-	-	-	-	-	-	-	-	-	-	✓	-	-	✓	-
Allianz Target Maturity Euro Bond I	-	-	-	-	-	-	-	✓	-	-	-	-	-	-	✓	-
Allianz Target Maturity Euro Bond II	-	-	-	-	-	-	-	✓	-	-	-	-	-	-	✓	-
Allianz Thematica	✓	-	-	-	-	-	-	-	-	-	-	-	-	✓	✓	-
Allianz Total Return Asian Equity	✓	-	-	-	-	-	-	-	-	-	-	-	-	-	✓	-
Allianz Treasury Short Term Plus Euro	-	-	-	-	-	-	-	✓	✓	-	-	-	-	-	✓	-
Allianz Trend and Brands	-	✓	-	-	✓	✓	✓	✓	-	✓	-	-	✓	✓	-	✓
Allianz UK Government Bond	-	-	-	-	-	-	-	-	✓	-	-	-	-	-	-	-
Allianz Unconstrained Multi Asset Strategy	✓	✓	✓	-	-	✓	✓	✓	✓	✓	✓	-	-	-	-	-
Allianz US Equity Fund	-	-	-	-	-	-	-	-	-	-	-	-	-	-	-	-
Allianz US Equity Plus	✓	-	-	-	-	-	-	✓	-	-	-	-	-	-	-	-
Allianz US Equity powered by Artificial Intelligence	-	-	-	-	-	-	-	-	-	-	-	✓	-	-	-	-
Allianz US High Yield	✓	-	-	✓	-	-	-	✓	-	-	-	-	-	-	-	-
Allianz US Investment Grade Credit	-	-	-	-	-	-	-	-	-	-	-	-	-	-	-	-
Allianz US Large Cap Value	-	-	-	-	-	-	-	-	-	-	-	✓	-	-	-	-
Allianz US Short Duration High Income Bond	✓	-	-	-	-	-	-	✓	-	-	-	-	-	-	✓	-
Allianz Volatility Strategy Fund	-	-	-	-	-	-	-	-	-	-	-	-	-	-	-	✓
IndexManagement Balance	✓	✓	-	-	-	-	-	✓	-	-	✓	✓	-	-	-	-
IndexManagement Chance	✓	✓	-	-	-	-	-	✓	-	-	✓	✓	-	-	-	-
IndexManagement Substanz	✓	✓	-	-	-	-	-	✓	-	-	✓	✓	-	-	-	-
IndexManagement Wachstum	✓	✓	-	-	-	-	-	✓	-	-	✓	✓	-	-	-	-

Appendix 1

General Investment Principles, Asset Class Principles and Sub-Funds' Specific Investment Objectives and Investment Restrictions

Part A: General Investment Principles applicable to all Sub-Funds ("General Investment Principles")

Investors can choose from a range of Sub-Funds and Share Classes.

When applying any investment strategy as mentioned in Appendix 1, a Sub-Fund's Investment Manager considers as part of its due diligence process all relevant financial risks, including all relevant sustainability risks that could have a significant negative impact on the return on an investment, in its investment decision and evaluates them on an ongoing basis. The Sustainability Risks assessment does not cover cash and Deposits, derivatives, and non-rated investments. Sustainability Risks are clustered as

- Sustainability macro risks with global relevance for all sub-funds (for example global warming and climate change).
- Sustainability sector risks with relevance for all funds exposed to specific sectors (for example stranded asset risks for Oil & Gas sector).
- Sustainability idiosyncratic risks on the level of individual corporate and sovereign issuers with relevance for all portfolios exposed to these issuers (for example climate transition risk).
- Sustainability investment risks on portfolio level that derive from portfolio exposure on Sustainability macro risk, Sustainability sector risks and in particular invested Sustainability issuers.

Sustainability risks are assessed using external sustainability research data and/or internal research and analysis. Both external and internal research aims at identifying potential financial risks of an investment in securities of an issuer related to sustainability. Issuers can be corporate issuers, sovereign issuers, or sub-sovereign agency issuers. Details can be found in the Risk Management Policy Statement available at <https://www.allianzgi.com/en/our-firm/esg>.

All products comply with the process described above. In addition, specific investment strategies in line with Article 8 and 9 of the Sustainability-related Disclosure Regulation have features that to some extent could limit certain risks, in particular reputational, e.g., exclusions of certain industries or of the worst rated issuers.

If a Sub-Fund's investment strategy is carried out in accordance with Art. 9 of the Sustainability-related Disclosure Regulation, all relevant information to be disclosed pursuant to Art. 5 of the Taxonomy Regulation in this regard may be found in **Appendix 10**. Sub-Funds are managed in accordance with Art. 9 (1), (2) or (3) of the Sustainability-related Disclosure Regulation if they have sustainable investment as its objective.

If a Sub-Fund's investment strategy is carried out in accordance with Art. 8 of the Sustainability-related Disclosure Regulation, all relevant information to be disclosed pursuant to Art. 6 of the Taxonomy Regulation in this regard may be found in **Appendix 10**. Sub-Funds are managed in accordance with Art. 8 (1) of the Sustainability-related Disclosure Regulation if they promote, amongst other characteristics, environmental or social characteristics, or a combination of those characteristics, provided that the companies in which the investments are made follow good governance practices.

Where a Sub-Fund's investment strategy is neither carried out in accordance with Art. 9 of the Sustainability-related Disclosure Regulation nor in accordance with Art. 8 of the Sustainability-related Disclosure Regulation, such Sub-Fund may be found in in **Appendix 10** by explicitly stating that Sub-

Fund's investments do not take into account the EU criteria for environmentally sustainable economic activities.

Furthermore, the Management Company consider PAI indicators on sustainability factors in a similar manner as described before in the course of all investment decisions to be taken for a Sub-Fund. Further details are included in the Management Company's Principal Adverse Impact Statement available on the website www.allianzglobalinvestors.com.

The assets of the Sub-Funds may, subject to a Sub-Fund's specific Asset Class Principles in combination with a Sub-Fund's individual Investment Restrictions and depending on market conditions, be either focused on:

- individual asset classes,
- individual currencies,
- individual themes,
- individual sectors,
- individual countries,
- individual regions,
- assets with shorter or longer (residual) maturities, and/or
- assets of issuers/debtors of a specific nature (e.g., government or corporate),

or may be more broadly invested.

The Investment Manager may select securities based on fundamental and/or quantitative analysis. In this process, individual securities are analysed, assessed, and selected in accordance with different investment processes. In order to generate sustained alpha, a Sub-Fund's Investment Manager may incorporate the analysis of the ever-growing data universe into the concrete investment process / investment strategy thereby embracing new statistical techniques which may include, but are not limited to, (i) machine learning and/or (ii) natural language processing and/or (iii) artificial intelligence (AI) to analyse the data efficiently for better and deeper exploitation of unrevealed information. The Investment Manager intend to use the latest available technology and techniques to derive investment signals according to the aforesaid possibilities. The allocation of these investment signals is always fully owned by a Sub-Fund's Investment Manager, who is responsible for both, the final implementation as well as the accounting for the performance. In all cases – independent if the Investment Manager makes use of the aforementioned new statistical techniques or not - a Sub-Fund's Investment Manager is always and solely responsible for the final decisions made in the context to analyse, to assess and to select individual securities.

A Sub-Fund's Investment Manager may invest in the corresponding securities of companies of all sizes, either directly or indirectly. Depending on the market situation, the Investment Manager may focus either on companies of a certain size or individually determined sizes or have a broad investment focus. The Sub-Fund may also invest in very small cap stocks, some of which operate in niche markets.

The Investment Manager may, also invest either directly or indirectly in Value Stocks and Growth Stocks. Depending on the market situation, the Investment Manager may either concentrate on Value Stocks or Growth Stocks or have a broad investment focus.

Where a theme and/or a sector is referred to in a Sub-Fund's investment objective (or in a Sub-Fund's investment restriction), the Investment Manager will (or if specifically restricted in a Sub-Fund's investment objective or investment restrictions, will not) make investments which have exposure or connection to such theme and/or sector. Such investments may include any securities and Money Market Instruments of companies that either

- (i) are included in publicly available financial indices (if any) or in segments (if any) as defined by the Global Industry Classification Standard – (GICS[®]) which refer to such theme and/or sector,
- (ii) currently generate (either directly or indirectly) a material part of their business activities (sales, profits or expenses) in such theme and/or sector,
- (iii) currently (either directly or indirectly) engage in the respective theme and/or sector and will likely - pursuant to the Investment Manager's discretionary assessment – materially increase the importance of such engagement on short-term or mid-term, or
- (iv) have substantial direct or indirect participation by way of ownership in the companies as described under (i) to (iii) above.

In the aforesaid scenarios the Investment Manager will focus primarily in securities and/or Money Market Securities of companies whose products or behaviour, in the Investment Manager's opinion, are part and/or are enablers and/or make a positive impact on such theme and/or sector.

The scenarios as described under the aforesaid items (iii) and (iv) may also include securities of companies with exposure or connection to the respective theme and/or sector on an ancillary basis (i.e., Equities, Debt Securities of companies which have exposure or connection to themes and/or sectors as not referred to in a Sub-Fund's investment objective (or in a Sub-Fund's investment restriction) ("such other themes and/or sectors") even if the exposure or connection to such other themes and/or sectors are more material than the exposure or connection to the theme and/or sector which is referred to in a Sub-Fund's investment objective (or in a Sub-Fund's investment restriction).

The Investment Manager orients the composition of each Sub-Fund under management depending on its assessment of the market situation and taking into consideration the specific Asset Class Principles and individual Investment Restrictions, which may result in the complete or partial reorientation of the composition of a Sub-Fund. For this reason, it is possible that such adjustments may be made even frequently.

Sub-Funds assets are invested according to the principle of risk diversification. The portfolio of each Sub-Fund will comprise eligible assets which have been selected following a thorough analysis of the information available to the Investment Manager and subject to a careful evaluation of the risks and opportunities. The performance of the Shares, however, remains dependent on price changes in the markets. Therefore, no guarantee can be given that the investment objectives of the Sub-Funds will be achieved, unless an explicit guarantee to this effect is mentioned for the respective Sub-Fund.

The Management Company may permit co-management of assets of one or more Sub-Funds with one or more other Sub-Funds and/or with other undertakings for collective investment managed by the Management Company. In such event, assets of the various Sub-Funds with the same Depositary will be managed jointly. The assets under co-management are referred to as a "pool", whereby such pools are, however, exclusively used for internal management purposes. The pools are not separate entities and are not directly accessible to investors. To each of the co-managed Sub-Funds shall be allocated its relevant specific assets.

When combining assets from more than one Sub-Fund in a pool, the assets attributable to each participating Sub-Fund are initially determined by applying the original allocation of assets of that Sub-Fund to the said pool. The assets change if the Sub-Fund adds or removes assets from the pool.

The entitlement of each participating Sub-Fund to the co-managed assets applies with regard to each individual asset of such a pool.

Additional investments made on behalf of the co-managed Sub-Funds are allocated to such Sub-Fund according to its respective entitlement. Sold assets are charged similarly against the assets attributable to each participating Sub-Fund.

The Investment Manager may, in particular, invest either directly or indirectly in eligible assets by using techniques and instruments relating to transferable securities and money market instruments for efficient portfolio management (including hedging) and/or investment purposes, if it is ensured by the Investment Manager, that the Sub-Fund adheres to its investment limits as set out in (i) the General Investment Principles, (ii) the Sub-Fund's specific Asset Class Principles and (iii) the Sub-Fund's individual investment restrictions. The use of such techniques and instruments should not result in a change of the declared investment objective of a Sub-Fund or substantially increase the risk profile of a Sub-Fund.

Where the provisions of this Appendix provide that an asset must have a rating by one or more Rating Agencies, such an asset may also have (i) an equivalent rating from another Rating Agency that is not mentioned in the Sub-Fund's Asset Class Principles and Investment Restrictions or (ii), if unrated, a rating of a comparable quality as determined by the Investment Manager's internal credit quality assessment. If an asset loses the minimum rating set out in the Sub-Fund's Asset Class Principles and Investment Restrictions, it must be sold within six months. Where a recognized Rating Agency has provided a rating of an ABS/MBS in question and/or a Debt Security (excluding ABS/BMS) in question, the Investment Manager of the Sub-Fund may use such rating and supplementary information and analysis within its internal credit quality assessment, while not solely or mechanically relying on the Rating Agency's provided rating.

In the case of a non-rated Debt Security, the Investment Manager may take a credit rating of the respective Debt Security's issuer into account. For the case that neither the concrete Debt Security nor the Debt Security's issuer is rated, the Investment Manager will assess the Debt Security's credit risk based on its internal credit quality assessment. The Investment Manager ensures that its internal credit quality assessment procedure includes, but is not limited to, the following general principles: (i) an effective process to obtain and update relevant information on the issuer and the respective instrument's characteristics (including, but not limited to quantitative and qualitative fundamentals which may include issuer's leverage, operating margin, return on capital, interest coverage, operating cash flows, industry outlook, firm's competitive position, and corporate governance issue); (ii) adequate measures to ensure that the internal credit quality assessment is based on a thorough analysis of the information that is available and pertinent, and includes all relevant driving factors that influence the creditworthiness of the issuer and the credit quality of the instrument in question.

The Investment Manager may invest in securities from developed countries. **Nevertheless, securities from Emerging Markets may also be acquired to a substantial extent or even fully. The weighting between investments in developed countries and emerging markets may fluctuate depending on the evaluation of the market situation and will be mentioned in the Sub-Fund's specific Asset Class Principles in combination with a Sub-Fund's individual Investment Objective. In addition, a Sub-Fund's concrete exposure in Emerging Markets is explicitly mentioned in a Sub-Fund's individual investment restrictions.**

The Investment Manager may invest in securities which are rated Investment Grade. Nevertheless, the Investment Manager may also acquire either High-Yield Investments Type 1 and/or High-Yield Investments Type 2 to a substantial extent or even fully. The weighting between investments in Investment Grade rated and/or High-Yield Investments Type 1 and/or High-Yield Investments Type 2 may fluctuate depending on the evaluation of the market situation and will be mentioned in the Sub-Fund individual investment restrictions or in the Sub-Fund specific asset class principles.

Where it is stated in a Sub-Fund's specific investment restrictions that the Investment Manager may invest in the China A-Shares market, the Investment Manager may invest in China A-Shares either directly through Stock Connect or via other foreign access regimes (e.g., FII Program), and/or via other means as may be permitted by the relevant regulations from time to time, or indirectly through eligible instruments as described in Appendix 1 Part B and/or in China B-Shares either directly or indirectly through eligible instruments as described in Appendix 1 Part B.

Where it is stated in a Sub-Fund's specific investment restrictions that the Investment Manager may invest in the PRC bond markets, the Investment Manager may invest in Debt Securities which are traded and/or admitted on the CIBM either directly or indirectly through the CIBM Initiative or via Bond Connect or via other foreign access regimes (e.g., FII Program), and/or via other means as may be permitted by the relevant regulations from time to time.

Investors assume the risk of receiving a lesser amount than they originally invested. In so far as there are no other relevant provisions contained in both, the Sub-Fund's specific Asset Class Principles and a Sub-Fund's individual investment restrictions, the following shall apply to all Sub-Funds:

1. Each Sub-Fund may invest in the following assets:

- a) Securities and Money Market Instruments that,
- are traded on a stock exchange or another Regulated Market of an EU Member State or of a third country, which operates regularly and is recognised and open to the public, or
 - are offered within the scope of initial public offerings, the issuing terms of which include the obligation to apply for admission to official listing on a stock exchange or in another Regulated Market (as detailed above), and the admission of which is obtained no later than one year after the issue.

Money market instruments are investments that are normally traded on the money market that are liquid and whose value can be determined precisely at any time.

Securities referring to indices may only be acquired if the respective index is compliant with Article 44 of the Law and Article 9 of the Grand-Ducal Regulation of 2008.

- b) Units of UCITS or other UCIs established in an EU Member State or in a third country, if:

- such other UCIs are authorised under laws which provide that they are subject to supervision considered by the CSSF to be equivalent to that laid down in EU law, and that cooperation between authorities is sufficiently ensured,
- the level of protection for the unitholders of the UCIs is equivalent to the level of protection for the unitholders of a UCITS, and in particular the provisions for separate safekeeping of fund assets, borrowing, lending, and short sales of securities and money market instruments are equivalent to the requirements of the UCITS Directive,
- the business operations of the UCIs are the subject of annual and semi-annual reports that make it possible to form a judgement concerning the assets and liabilities, the income and transactions in the reporting period,
- no more than 10% of the assets of the UCITS or of the other UCIs whose acquisition is contemplated, can, according to their management regulations or instruments of incorporation, be invested in aggregate in units of other UCITS or other UCI.

A Sub-Fund may also invest in Shares issued by another Sub-Fund (the "Target Sub-Fund") provided that:

- the Target Sub-Fund does not invest in the Sub-Fund invested in the Target Sub-Fund, and
 - no more than 10% of the assets of the Target Sub-Fund may, pursuant to its investment policy, be invested in aggregate in Shares of other Sub-Funds, and
 - voting rights, if any, attaching to the relevant Shares are suspended for as long as they are held by the Sub-Fund invested in the Target Sub-Fund and without prejudice to the appropriate processing in the accounts and the periodic reports,
 - in any event, for as long as these shares are held by the Sub-Fund, their value will not be taken into consideration for the calculation of the net assets of the Company for the purposes of verifying the minimum threshold of the net assets imposed by the Law, and
 - there is no duplication of Sales Charges or redemption fees between those at the level of the Sub-Fund invested in the Target Sub-Fund and those at the level of the Target Sub-Fund.
- c) Time deposits and/or deposits at sight ("Deposits") with a credit institution which are repayable on demand or have the right to be withdrawn, and maturing in no more than 12 months, provided that the credit institution has its registered office in an EU Member State or, if the registered office of the credit institution is situated in a third country, provided that it is subject to prudential rules considered by the CSSF as equivalent to those laid down in EU law. Time deposits are generally held in interest-bearing bank accounts that have a pre-set date of maturity. Deposits at sight are limited to cash held in current accounts with a bank accessible at any time to cover current or exceptional payments. The Deposits may in principle be denominated in all currencies permitted by the investment policy of the Sub-Fund.
- d) Financial derivative instruments ("Derivatives"), e.g., in particular futures-contracts, forward contracts, options and swaps including equivalent instruments settled in cash, which are traded on Regulated Markets described in letter a) above, and/or derivative financial instruments that are not traded on Regulated Markets ("OTC derivatives"), if the underlying securities are instruments as defined under letter a) and b) and in which a Sub-Fund may invest in accordance with its investment objective, or financial indices, interest rates, exchange rates or currencies. Financial indices for this purpose include, specifically, currency, exchange-rate, interest-rate, price and overall interest-rate return indices, as well as, in particular, bond, equity, commodity futures, precious metal and commodity indices and indices on additional permissible instruments listed under this number. For the avoidance of doubt, no derivative transaction will be entered into which provides for a physical delivery of any component of an underlying commodity futures, precious metal, and commodity indices.

In addition, the following conditions must also be fulfilled for OTC derivatives:

- The counterparties must be top-rated financial institutions, specialised in such transactions, which has been rated by a recognized rating agency (e.g., Moody's, S&P or Fitch) with at least Baa3 (Moody's), BBB- (S&P or Fitch) and be institutions subject to prudential supervision, and belonging to the categories approved by the CSSF. There are no further restrictions with regard to legal status or country of origin of the counterparty.
- The OTC derivatives must be subject to a reliable and verifiable valuation on a daily basis and may be sold, liquidated or closed out by an offsetting transaction at any time at a reasonable price.

- The transactions must be effected on the basis of standardised contracts.
 - The transactions shall be subject to the Company's collateral management policy as described in 13. below.
 - The Company must deem the purchase or sale of such instruments, instead of instruments traded on a stock exchange or in a Regulated Market, to be advantageous to Shareholders. The use of OTC derivatives is particularly advantageous if it facilitates a hedging of assets at matching maturities, thus being less expensive.
- e) Money Market Instruments that are not traded on a Regulated Market and do not fall under the definition under No. 1. a) above, provided that the issuer of these instruments is itself subject to regulations concerning deposit and investor protection. The requirements for deposit and investor protection are fulfilled for money market instruments if these instruments are rated investment grade by at least one recognised rating agency or the Company considers that the credit rating of the issuer corresponds to a rating of investment grade. These money market instruments must also be
- issued or guaranteed by a central governmental, regional, or local body or the central bank of an EU Member State, the European Central Bank, the EU or the European Investment Bank, a third country or if a federal state, a state of this federal state, or by an international organisation under public law, to which at least one member state belongs, or
 - issued by a company whose securities are traded on the Regulated Markets described under No. 1. a) above, or
 - issued or guaranteed by an institution that is subject to official supervision in accordance with criteria set down in European Community law, or an institution that is subject to regulatory provisions, which in the opinion of the CSSF, are equivalent to European Community law, or
 - issued by other issuers who belong to a category that was admitted by the CSSF, provided that regulations for investor protection apply to investors in these instruments, which are equivalent to those of the first, second or third bullet points and provided the issuer is either a company having a share capital of at least EUR 10 million, which prepares and publishes its annual financial statements according to the requirements of the Fourth Directive 78/660/EEC, or is a legal entity, which within a group of one or several listed companies, is responsible for the financing of this group, or is a legal entity, which is intended to finance the securitisation of debt by utilising a credit line granted by a financial institution.

2. Each Sub-Fund may also conduct the following transactions:

- invest of up to 10% of the assets of a Sub-Fund in securities and Money Market Instruments other than those listed under No. 1. – subject to the provisions of the relevant Sub-Fund individual Investment Restrictions,
- raise short-term loans of up to 10% of the Sub-Fund's net assets, provided the Depositary agrees to the borrowing and the terms of the relevant loan; the Sub-Fund individual Investment Restrictions or in the Sub-Fund's specific Asset Class Principles will give an only declarative indication. Not included in this 10% limit, but permissible without the approval of the Depositary, are foreign currency loans in the form of back-to-back loans.

3. In investing the assets of the Company, each Sub-Fund must observe the following restrictions:

- a) On behalf of a Sub-Fund, the Company may purchase securities or money market instruments of an issuer, provided that the aggregate value of such securities and the value of securities issued by the same issuer which are already contained in a Sub-Fund does not exceed 10% of the Sub-Fund's net assets at the time of purchase. A Sub-Fund may invest a maximum of 20% of its net assets in Deposits at one institution. The default risk of the counterparties in OTC derivatives may not exceed 10% of a Sub-Fund's net assets if the counterparty is a credit institution within the meaning of No. 1 c); for other cases, the maximum limit is 5% of a Sub-Fund's net assets. The aggregate value in a Sub-Fund's net assets of securities and money market instruments of issuers where a Sub-Fund has invested more than 5% of its net assets in securities and money market instruments of the same issuer may not exceed 40% of a Sub-Fund's net assets. This restriction does not apply to Deposits and to transactions with OTC derivatives that are effected with financial institutions that are subject to official supervision.
- A Sub-Fund may invest in ancillary liquid assets which are limited to deposits at sight, such as cash held in current accounts with a bank accessible at any time to cover current or exceptional payments,

or for the time necessary to reinvest in eligible assets according to Appendix 1, Part A, Nr. 1 or for a period strictly necessary in case of unfavorable market conditions. The holding of such ancillary liquid assets is limited to 20% of a Sub-Fund's net assets. Such 20% limit shall only be temporarily breached for a period strictly necessary when, because of exceptionally unfavorable market conditions, circumstances so require and where such breach is justified by the interests of a Sub-Fund's shareholders.

Irrespective of the individual investment limits cited above, a Sub-Fund may not invest more than 20% of its net assets in aggregate in:

- the securities or money market instruments issued by a single body,
 - Deposits with that body and/or
 - exposures arising under OTC derivatives entered into with that body.
- b) If the purchased securities or money market instruments are issued or guaranteed by an EU Member State or its central, regional, or local authorities, a third country, or by international organisations under public law to which one or more member states of the EU belong, the restriction under the first sentence of 3 a) above is increased from 10% to 35% of the Sub-Fund's net assets.
- c) In the case of bonds issued by credit institutions domiciled in an EU Member State, where the respective issuers are subject to a special official supervision due to statutory provisions protecting bondholders, the restrictions under No. 3. a) sentences 1 and 4 are increased from 10% to 25% and 40% to 80%, respectively, provided that these credit institutions invest the issuing proceeds, pursuant to the respective statutory provisions, in assets which sufficiently cover the liabilities from bonds for their whole term to maturity, and which, as a matter of priority, are intended for capital and interest repayments becoming due on the issuer's default.
- d) The securities and money market instruments cited under No. 3. b) and c) above will not be considered when applying the 40% investment limit provided under No.3 a) sentence 4. The restrictions under No.3 a) to c) do not apply on a cumulative basis. Therefore, investments in securities or money market instruments of the same issuer or in Deposits with this issuer or in derivatives of the same may not exceed 35% of the Sub-Fund's net assets. Companies that, with respect to the preparation of their consolidated financial statements in accordance with Directive 83/349/EEC or according to accepted international accounting standards, belong to the same group of companies, are regarded as one issuer when calculating the investment limits listed under No.3 a) to d). A Sub-Fund may invest up to 20% of its net assets in securities and money market instruments of one group of companies.
- e) Investments in derivatives are included in the limits of the numbers listed above.
- f) **In derogation of the limits listed under No.3 a) to d), each Sub-Fund may invest in accordance with the principle of risk diversification up to 100% of a Sub-Fund's assets in securities and money market instruments of different issues being offered or guaranteed by the EU, the European Central Bank, an EU Member State or its local authorities, by a member state of the OECD, by international organisations under public law to which one or more member states of the EU belong, or by any other non-EU Member State which is officially accepted by the CSSF from time to time (as at the date of this prospectus, the following non-EU Member States are accepted by the CSSF: The special administrative region of Hong Kong, the People's Republic of China, the Federal Republic of Brazil, the Republic of India, the Republic of Indonesia, the Russian Federation, the Republic of South Africa, the Republic of Singapore), provided that such securities and money market instruments have been offered within the framework of at least six different issues, with the securities and money market instruments of one and the same issue not to exceed 30% of the Sub-Fund's net assets.**
- g) A Sub-Fund may purchase units of other UCITS, or UCIs as defined under No. 1 b) up to a total of 10% of its net Sub-Fund assets. In derogation of this, the Board may decide that a higher percentage or all of a Sub-Fund's net assets may be invested in units of other UCITS or UCIs as defined under No.1 b), which will be explicitly mentioned in the Sub-Fund's individual Investment Restrictions or in the Sub-Fund's specific Asset Class Principles. In this case a Sub-Fund may not invest more than 20% of its net Sub-Fund assets in a single UCITS or UCI. When this investment limit is applied, each sub-fund of an umbrella fund as defined under Article 181 of the Law must be considered to be an independent

investment fund if the principle of separate liability with regards to third parties is applied to each sub-fund. Similarly, in this case investments in units of other UCIs than UCITS may not exceed a total of 30% of a Sub-Fund's net assets.

Moreover, the Board may decide to allow the investment in units of a master fund qualifying as a UCITS provided that the relevant Sub-Fund (the "Feeder Sub-Fund") invests at least 85% of its Net Asset Value in units of such master fund and that such master fund shall neither itself be a feeder fund nor hold units of a feeder fund, which will be explicitly mentioned in the Sub-Fund's individual Investment Restrictions or in the Sub-Fund's specific Asset Class Principles.

A Feeder Sub-Fund may hold up to 15% of its assets in one or more of the following:

- ancillary liquid assets in accordance with Article 41 paragraph 2 second sub-paragraph of the Law,
- Derivatives, which may be used only for hedging purposes, in accordance with Article 41 paragraph 1, letter g) and Article 42 paragraphs 2 and 3 of the Law,
- movable and immovable property which is essential for the direct pursuit of the Company's business.

If a Sub-Fund has acquired units of a UCITS or a UCI, the investment values of the relevant UCITS or UCIs are not considered with regard to the investment limits stated under No.3 a) to d).

If a Sub-Fund acquires shares of a UCITS or UCI which is directly or indirectly managed by the same company or by another company with which the Company is linked by common management or control, or by a substantial direct or indirect participation (at least 10% of the capital or the votes) then neither the Company nor the associated company may charge fees for the subscription or redemption of units.

If a Sub-Fund invests a substantial portion of its assets in other UCITS and/or other UCI as defined above, a management fee at the level of such UCITS or UCI (excluding any performance fee, if any) of no more than 2,50% per annum of their net asset value may be charged.

- h) Irrespective of the investment limits set down in letter i) below, the Board may determine that the upper limits stated in letters a) to d) above for investments in equities and/or debt instruments of a single issuer amount to 20% if the objective of the Sub-Fund's investment strategy is to replicate a specific equity or bond index recognised by the CSSF, provided that
- the composition of the index is adequately diversified,
 - the index represents an adequate benchmark for the market to which it refers,
 - the index is published in an appropriate manner.

The limit of 20% is raised to 35% provided this is justified based on exceptional market conditions, and in particular in Regulated Markets where certain securities or money market instruments are in a strongly dominant position. An investment up to this limit is only possible with a single issuer. The limit in accordance with a) above does not apply.

- i) Each Sub-Fund may acquire securities as defined under No.1 a) referring to
- (i) Equities (including assets of companies operating in the private equity sector),
 - (ii) Debt Securities,
 - (iii) UCITS and UCI as defined under No.1 b),
 - (iv) indices, including bond, equity (including assets of companies operating in the private equity sector), hedge funds indices and indices on commodity futures, precious metals, or commodities as well as indices that refer to companies active in the area of private equity; securities referring to indices other than financial indices are only to be acquired if they are geared towards a 1:1 replication of the underlying index/indices,
 - (v) single hedge funds and funds of hedge funds,
 - (vi) commodities,
 - (vii) precious metals (but only if this security is a certificate referring to precious metals),
 - (viii) commodity forward contracts,
 - (ix) real estate property funds, and/or
 - (x) baskets of the aforementioned underlying assets.

The aforementioned securities may be acquired regardless of whether the underlying asset can be replaced or modified under the respective terms and conditions of the security, as long as the replaced or modified underlying asset is one that is admissible for securities as defined in this letter.

Securities referring to an underlying asset as defined under letter i) No. (v) to No. (ix) may only be acquired if they are geared towards a 1:1 replication of the respective underlying asset. This applies accordingly to securities as defined under letter i) No. (x), insofar as they have underlying assets as defined under letter i) No. (v) to No. (viii).

Securities with an underlying asset as defined under letter i) No. (vi) to No. (viii) may **not provide for any mandatory physical delivery** or grant the issuer the right to make physical delivery of the relevant underlying asset. This applies accordingly to securities as defined under letter i) No. (x), insofar as they have underlying assets as defined under letter i) No. (vi) to No. (viii).

- j) The Company may not acquire voting shares carrying a voting right for any of its investment funds to an extent to which it would be permitted to exercise a significant influence over the management of the issuer. A Sub-Fund may acquire a maximum of 10% of the non-voting shares, bonds, and money market instruments of any one and a maximum of 25% of the shares or units of a UCITS or a UCI. This limit does not apply to the acquisition of bonds, money market instruments and target fund units if the total amount issued or the net amount of the shares issued cannot be calculated. It also does not apply inasmuch as these securities and money market instruments are issued or guaranteed by an EU Member State or its central, regional or local authorities or by a third country, or are issued by international organisations under public law to which one or more member states of the EU belong.

The restrictions stated under the first bullet point of 2 and 3 above refer to the time the assets are acquired. If the limits set are subsequently exceeded because of price movements or due to reasons beyond the control of the Company, the Company will adopt as its primary objective the remedying of such situation, taking due account of the interests of its Shareholders.

4. Derogation from investment restrictions

- a) The Company does not need to comply with the limits set forth under 1, 2 and 3 above when exercising subscription rights attaching to transferable securities or money market instruments which form part of its assets.

While ensuring observance of the principle of risk spreading, recently created Sub-Funds may derogate from 1, 2 and 3 above for a period of no more than six months following the date of their launch.

- b) If the limits referred to in the preceding paragraph are exceeded for reasons beyond the control of the Company or as a result of the exercise of subscription rights, it must adopt as a priority objective for its sales transactions the remedying of that situation, taking due account of the interests of the Shareholders.
- c) While ensuring observance of the principle of risk spreading, Sub-Funds may derogate from the applicable investment restrictions and limits set out in the Sub-Fund's specific Asset Class Principles and in the Sub-Fund's individual Investment Restrictions during the first six months after the Sub-Fund's launch and during the last two months prior to the Sub-Fund's liquidation or merger.

5. The Company is not permitted to enter into the following transactions:

- a) No Sub-Fund may assume liabilities in connection with the purchase of partly paid securities, the aggregate of which including loans as stipulated in 2 second indent exceeds 10% of the Sub-Fund's net assets.
- b) No Sub-Fund may grant loans, or act as guarantor on behalf of third parties.
- c) No Sub-Fund may acquire securities the disposal of which is subject to any kinds of restrictions due to contractual provisions.
- d) No Sub-Fund may invest in real estate, although real estate-backed securities or money market instruments or interests in such investments, or investments in securities or money market instruments

issued by companies which invest in real estate (such as REITs), and interests in such investments are permitted.

- e) No Sub-Fund may acquire precious metals or certificates on precious metals.
- f) No Sub-Fund may pledge or charge assets, transfer them as collateral, or assign them as collateral, unless this is required within the framework of a transaction permitted under the Prospectus. Such collateral agreements are applicable in particular to OTC trades in accordance with 1 d) ("Collateral Management").
- g) No Sub-Fund may conduct short sales of securities, money market instruments or target fund shares.
- h) Pursuant to the investment restrictions applicable under Hong Kong requirements, the total aggregate investments by the Company in any ordinary shares issued by any single issuer may not exceed 10%.

6. Use of Techniques and Instruments

Subject to the specific investment restrictions of a Sub-Fund, the investment objective, the General Investment Principles and the specific Asset Class Principles of Sub-Funds may be achieved through the use of techniques and instruments as described below.

Techniques and Instruments refer to the purchase of listed and non-listed (OTC) derivatives, including, without limitation, futures, options, forward transactions, financial instruments with embedded derivatives (structured products), credit default swaps, other swaps and instruments which provides returns based on other investments, securities, money market instruments, funds, other derivatives, financial indices, basket of securities, currencies, exchanges rates, interest rates, commodities, and other eligible so called "underlyings" etc.

In the case of credit default swaps, the respective counterparties of such credit default swaps must be top-rated financial institutions specialising in such transactions. Both the underlying and the counterparties to the credit default swap must be taken into account with regard to the investment limits set out in No. 3 above. Credit default swaps are valued on a regular basis using clear and transparent methods, which will be monitored by the Company and the Independent Auditor. If the monitoring should reveal irregularities, the Company will arrange for these to be resolved and eliminated.

Subject to specific investment restrictions of a Sub-Fund, techniques and instruments may be either (i) used for efficient portfolio management (including hedging) and/or (ii) investment purposes. The use of techniques and instruments may involve entering into market-contrary transactions, which, for example, could lead to gains if prices of underlyings fall, or to losses if the prices rise. They may also be restricted by market conditions or regulatory restrictions and there are no assurances that their implementation will achieve the desired result.

Use of such investment strategies may be restricted by market conditions or as a result of regulatory restrictions and there is no assurance that the pursuit of such strategies will in fact achieve the desired aim.

Derivatives

The Company may use a wide variety of derivatives, which may also be combined with other assets. The Company may also acquire securities and money-market instruments which embed one or more derivatives. Derivatives are based on "underlyings". These "underlyings" may be the admissible instruments listed in Appendix 1 Part B or they may be financial indices, interest rates, exchange rates or currencies. Financial indices here include, specifically, currency, exchange-rate, interest-rate, price and overall interest-rate return indices, as well as the continued use of bond and equity indices, indices on the additional permissible instruments listed in Appendix 1 Part B, and commodity futures, precious metal and commodity indices.

Set out hereafter are examples of the function of selected derivatives that a Sub-Fund may use depending on its specific investment restrictions:

Options

The purchase of a call or put option is the right to buy or sell a specific “underlying” at a fixed price at a future time or within a specific period of time or to enter into or terminate a specific contract. An option premium is paid for this right, which is payable whether or not the option is exercised.

The sale of a call or put option, for which the seller receives an option premium, is the obligation to sell or buy a specific “underlying” at a fixed price at a future time or within a specific period of time or to enter into or terminate a specific contract.

Futures-Contracts

Futures-contracts are exchange-traded instruments, and their dealing is subject to the rules of the exchanges on which they are dealt. The amounts of the underlying asset cannot be changed nor can the settlement date for the contract. Trades in futures are conducted via brokers who execute for the respective Sub-Fund’s portfolio and/or clear the contracts for the sub-fund’s portfolio on the exchange. Futures-contracts are subject to margin provisions. At the time of purchase or sale, initial margin is posted to the exchange via the clearing broker. As the price of the contract rises or falls with the price of the underlying, variation margin is posted or received by the sub-fund’s portfolio via a clearing broker.

Futures-Contracts on equity indices (equity index futures) will be used for both, efficient portfolio management and hedging purposes. An equity index future is a futures-contract whose underlying instrument is an equity index. The market value of an index future tends to rise and fall in relation to the underlying index. The price of an index future will generally increase as the level of its underlying increases.

Interest rate and currency futures-contracts are used to increase or reduce interest rate or currency exposure to a particular market. Buying interest rate or currency futures provides the respective Sub-Fund with interest rate exposure to the government bond interest rates in a given country or currency area (e.g., Eurozone). Selling futures-contract reduces interest rate or currency exposure in the same way. Futures-contracts will sometimes be used by the respective Sub-Fund in combination with other securities. For example, by buying corporate bonds and selling a duration-weighted amount of other bond futures-contracts against those purchases, the respective Sub-Fund can take advantage of movements in credit spreads without having exposure to interest rate risk in that market.

Exchange traded bond, currency and interest rate futures may be used as a cost-efficient alternative to taking outright positions in underlying securities or for hedging specific risk in relation to a Sub-Fund’s portfolio holding.

Forward Transactions

A forward transaction is a mutual agreement that authorises or obliges the counterparties to accept or to deliver a specific “underlying” at a fixed price and at a specific time, or to make a corresponding cash settlement available. As a rule, only a fraction of the size of any contract must be paid upfront (“margin”).

Contract for Difference

A contract for difference is a contract between the Company and a counterparty. Typically, one party is described as “buyer” and “seller”, stipulating that the seller will pay to the buyer the difference between the current value of an asset and its value at contract time (If the difference is negative, then the buyer pays instead to the seller). Contract for differences may be used to take advantage of prices moving up (long positions) or prices moving down (short positions) on underlying financial instruments and are often used to speculate on those markets. For example, when applied to equities, such a contract is an equity derivative that allows the portfolio manager to speculate on share price movements, without the need for ownership of the underlying shares.

Swaps

A swap is a transaction in which the reference values underlying the transaction are swapped between the counterparties. The Company may, in particular, enter into interest-rate, currency, equity, bond and money-market related swap transactions, as well as credit default swap transactions within the framework of the Sub-Fund’s investment strategy. The payments due from the Company to the counterparty and vice versa are calculated by reference to the specific instrument and an agreed upon notional amount.

Credit default swaps are credit derivatives that transfer the economic risk of a credit default to another party. Credit default swaps may be used, among other things, to hedge creditworthiness risks arising from

bonds acquired by a Sub-Fund (e.g., government or corporate bonds). As a rule, the counterparty may be obliged to buy the bond at an agreed price or pay a cash settlement upon the occurrence a previously defined event, such as the insolvency of the issuer, occurs. The buyer of the credit default swap pays a premium to the counterparty as consideration for assuming the credit default risk.

OTC Derivative Transactions

The Company may enter into transactions both in derivatives that are admitted for trading on an exchange or on another Regulated Market, as well as so-called over-the-counter transactions (OTC transactions). In OTC transactions, the counterparties enter into direct, non-standardised agreements that are individually negotiated and that contain the rights and obligations of the counterparties. OTC derivatives often have only limited liquidity and may be subject to relatively high price fluctuations.

The use of derivatives to hedge an asset of a Sub-Fund is intended to reduce the economic risk inherent in that asset. This also has the effect, however, of eliminating the Sub-Fund's participation in any positive performance of the hedged asset.

A Sub-Fund incurs additional risks when using derivative instruments to increase returns in pursuit of its investment objective. These additional risks depend on the characteristics both of the respective derivative and of the "underlying". Derivative investments may be subject to leverage, with the result that even a small investment in derivatives could have a substantial, even negative, effect on the performance of a Sub-Fund.

Any investment in derivatives is associated with investment risks and transaction costs which a Sub-Fund would not be exposed to were it not to pursue such strategies.

Specific risks are associated with investing in derivatives and there is no guarantee that a specific assumption by the Investment Manager will turn out to be accurate or that an investment strategy using derivatives will be successful. The use of derivatives may be associated with substantial losses which depending from the particular derivative used may even be theoretically unlimited. The risks are primarily those of general market risk, performance risk, liquidity risk, creditworthiness risk, settlement risk, risk of changes in underlying conditions and counterparty risk. The following can be emphasized in connection with this:

- The derivatives used may be misvalued or – due to different valuation methods – may have varying valuations.
- The correlation between the values of the derivatives used and the price fluctuations of the positions hedged on the one hand, and the correlation between different markets/positions hedged by derivatives using underlyings that do not precisely correspond to the positions being hedged may be imperfect, with the result that a complete hedging of risk is sometimes impossible.
- The possible absence of a liquid secondary market for any particular instrument at a certain point in time may result in it not being possible to close out a derivative position even though it would have been sound and desirable to do so from an investment perspective.
- OTC markets may be particularly illiquid and subject to high price fluctuations. When OTC derivatives are used, it may be that it is impossible to sell or close out these derivatives at an appropriate time and/or at an appropriate price.
- There is also the possible risk of not being able to buy or sell the "underlyings" that serve as reference values for the derivative instruments at a time that would be favourable to do so or being compelled to buy or sell the underlying securities at a disadvantageous time.

For derivative investments through certificates, there are also the additional general risks associated with investment in certificates. A certificate vests the right, under conditions set forth in detail in the terms and conditions of the issuer of the certificate, for the issuer of the certificate to demand the payment of an amount of money or to deliver certain assets on the settlement date. Whether, and if so, the extent to which the holder of a certificate has a corresponding claim on performance, depends on certain criteria, such as the performance of the underlying security during the term of the certificate or its price on certain days. As an investment instrument, certificates essentially contain the following risks (related to the issuer of the certificate): the creditworthiness risk, the company-specific risk, the settlement default risk and the counterparty risk. Other risks that should be emphasised are the general market risk, the liquidity risk and, if applicable, the currency risk. Certificates are as a rule not hedged through other assets or through third-party guarantees.

Where applicable, (1) certain techniques and instruments are accounted for based on their delta-weighted values, (2) market-contrary transactions are considered to reduce risk even where underlyings and the Sub-Fund assets are not matched.

The Investment Manager may, in particular, invest either directly or indirectly in eligible assets by using techniques and instruments relating to transferable securities and money markets instruments for efficient portfolio management (including hedging) and/or investment purposes, if it is ensured by the Investment Manager, that the Sub-Fund adheres to its investment limits as set out in (i) the General Investment Principles, (ii) the specific Asset Class Principles and (iii) the Sub-Fund's specific Investment Restrictions. The use of such techniques and instruments should not result in a change of the declared investment objective of a Sub-Fund or substantially increase the risk profile of a Sub-Fund.

For this purpose, the techniques and instruments are taken into account with the delta-weighted value of the respective underlyings in the manner prescribed. Market-contrary techniques and instruments are considered to reduce risk even when their underlyings and the assets of the Sub-Funds are not precisely matched.

In the case of efficient portfolio management, techniques and instruments are used where:

- a) they are cost-effective,
- b) they are entered into to reduce risk or cost or to generate additional capital or income with risk levels which is consistent with the risk profile of the Sub-Fund and applicable risk diversification rules,
- c) their risks are adequately captured by the risk management process of the Company.

The use of techniques and instruments may not

- a) result in a change of the Sub-Fund's investment objective,
- b) add substantial risks to the risk profile of the Sub-Fund.

The Investment Managers follows a risk-controlled approach in the use of techniques and instruments.

7. Securities (Reverse) Repurchase Agreements, Securities Lending Transactions

The Company may not enter into (reverse) repurchase agreements and into securities lending transactions.

8. Buy-Sell Back Transactions / Sell-Buy Back Transactions, Margin Lending Transactions

A Sub-Fund may **not** enter into buy-sell back transactions or sell-buy back transactions.

A Sub-Fund may **not** enter into margin lending transactions.

9. Total Return Swaps (TRS) and financial instruments with similar characteristics

A Sub-Fund may enter into Total Return Swaps ("TRS") in accordance with the requirements as set out in the Securities Financing Transactions Regulation. Total return swaps are derivatives that transfer the total economic performance, including income from interest and fees, gains and losses from price movements, and credit losses, of a reference obligation to another party. Total return swaps may be used, among other things, to exchange the performance of two different portfolios, e.g., the performance of certain assets of a sub-fund towards the performance of an index or an external portfolio which may be managed pursuant to a particular strategy as more detailed described in the Sub-Fund's investment restrictions. If Total Return Swaps are used, the counterparties have no influence on the composition or administration of the respective underlying. The selected counterparties comply with the requirements of Article 3 of the Securities Financing Transactions Regulation.

In addition, a Sub-Fund may enter into financial instruments with similar characteristics to a total return swap (so called "contract for differences" or "CFD"). CFDs are derivatives that allow traders to take advantage of prices moving up (long positions) or prices moving down (short positions) on all underlying financial instruments. A CFD is a tool of leverage with its own potential profits and losses. By using CFDs a Sub-Fund may enter the global markets without directly dealing with shares, indices, commodities or currency pairs.

10. Securities Financing Transactions Regulation

A Sub-Fund may enter into TRS/CFDs as set out in this section and section No. 9 above.

A Sub-Fund may enter into TRS/CFDs for investment purposes and for efficient portfolio management purposes.

In this context, efficient portfolio management purposes include: the reduction of risk, the reduction of cost and the generation of additional capital or income for the Sub-Fund with a level of risk that is consistent with the risk profile of the Sub-Fund.

If a Sub-Fund invests in TRS and/or CFDs, the relevant asset or index may be comprised of Equity or Debt Securities, Money Market Instruments or other eligible investments which are consistent with a Sub-Fund's specific Asset Class Principles, individual Investment Objective and Investment Restrictions.

Proportions of a Sub-Fund's Net asset value subject to TRS/CFD

Both, the maximum and the expected proportion of the Net Asset Value of a Sub-Fund that can be subject to TRS/CFDs are disclosed in Appendix 7.

According to the requirements of the Securities Financing Transaction Regulation the expected proportion as pointed out in Appendix 7 is not a limit and the actual percentage may vary over time depending on factors including, but not limited to, market conditions.

The maximum figure as pointed out in Appendix 7 is a limit.

A Sub-Funds shall only enter into TRS/CFDs with counterparties that satisfy the criteria (including those relating to legal status, country of origin and minimum credit rating) as set out in in this Appendix particularly in No. 7 above.

The underlyings of TRS/CFDs are securities which may be acquired for the Sub- Fund or financial indices within the meaning of Article 9 (1) of Directive 2007/16/EC, interest rates, foreign exchange rates or currencies into which the Sub-Fund may invest in accordance with its investment policy.

The categories of collateral which may be received by a Sub-Funds are set out in section No. 13 below and includes cash and non-cash assets such as equities, interest-bearing securities and money market instruments. Collateral received by the Funds will be valued in accordance with the valuation methodology set out under Section XI.1., headed "Calculation of NAV per Share".

Where a Sub-Fund receives collateral as a result of entering into TRS/CFDs, there is a risk that the collateral held by a Sub-Fund may decline in value or become illiquid. In addition, there can also be no assurance that the liquidation of any collateral provided to a Sub-Fund to secure a counterparty's obligations under a TRS/CFD would satisfy the counterparty's obligations in the event of a default by the counterparty. Where a Sub-Fund provides collateral as a result of entering into TRS/CFDs, it is exposed to the risk that the counterparty will be unable or unwilling to honour its obligations to return the collateral provided.

For a summary of certain other risks applicable to TRS/CFDs, see section No. 9.

A Sub-Fund may provide certain of its assets as collateral to counterparties in connection with TRS/CFDs. If a Sub-Fund has over-collateralised (i.e., provided excess collateral to the counterparty) in respect of such transactions, it may be an unsecured creditor in respect of such excess collateral in the event of the counterparty's insolvency. If the Depositary or its sub-custodian or a third party holds collateral on behalf of a Sub-Fund, the Sub-Fund may be an unsecured creditor in the event of the insolvency of such entity.

There are legal risks involved in entering into TRS/CFDs which may result in loss due to the unexpected application of a law or regulation or because contracts are not legally enforceable or documented correctly.

Subject to the restrictions laid down in section No. 13 below, a Sub-Fund may re-invest cash collateral that it receives. If cash collateral received by a Sub-Fund is re-invested, the Sub-Fund is exposed to the risk of loss on that investment. Should such a loss occur, the value of the collateral will be reduced, and the Sub-Fund will have less protection if the counterparty defaults. The risks associated with the re-investment of cash collateral are substantially the same as the risks which apply to the other investments of the Sub-Fund.

11. Potential impact of the use of techniques and instruments on the performance of each Sub-Fund

The use of techniques and instruments might have a positive and a negative impact on the performance of each Sub-Fund.

The Sub-Funds may use derivatives for hedging purposes. This may lead to correspondingly lower opportunities and risks in the general Sub-Fund profile. Hedging can be used in particular to reflect the different currency-hedged Share Classes and thus to mark the profile of the respective Share Class.

The Sub-Funds may also employ derivatives in a speculative sense in order to increase returns in pursuing the investment objective, in particular, to represent the general Sub-Funds' profiles and to increase the level of investment above the level of investment of a fund that is fully invested in securities. In reflecting the general Sub-Funds' profiles through derivatives, the general Sub-Funds' profiles will be implemented through the replacement of direct investments in securities, for example, by investments in derivatives or also, in shaping the general Sub-Funds' profiles, specific components of the Sub-Funds' investment objectives and principles may be derivative based, for example reflecting currency positions through investments in derivatives, which normally will not have a substantial effect on the general Sub-Funds' profiles. In particular, if a Sub-Fund's investment objective states that, with the objective of achieving additional returns, the Investment Managers may also assume separate foreign currency risks with regard to certain currencies and/or separate risks with regard to equities, bonds and/or commodity futures indices and/or precious metals indices and/or commodity indices these components of the investment objectives and principles are predominantly derivative based.

If the Sub-Funds employ derivatives to increase the level of investment, they do so in order to achieve a medium to long-term risk profile that offers potentially much greater market risk than that of a fund with a similar profile that does not invest in derivatives.

The Investment Managers follow a risk-controlled approach in the use of derivatives.

12. Policy regarding direct and indirect operational costs/fees on the Use of Techniques and Instruments

Direct and indirect operational costs and fees arising from the efficient portfolio management techniques including TRS/CFD may be deducted from the revenue delivered to the Sub-Funds. These costs and fees should not include hidden revenue. All the revenues arising from such efficient portfolio management techniques, net of direct and indirect operational costs, will be returned to the relevant Sub-Fund. The entities to which direct and indirect costs and fees may be paid include banks, investment firms, broker-dealers or other financial institutions or intermediaries and may be related parties to the Management Company or the Investment Manager. The revenues arising from such efficient portfolio management techniques for the relevant reporting period, together with the direct and indirect operational costs and fees incurred and the identity of the counterparty(ies) to these efficient portfolio management techniques, will be disclosed in the annual and semi-annual reports of the Sub-Funds.

13. Collateral Management Policy

When entering into OTC derivatives transactions or efficient portfolio management techniques the Company will observe the criteria laid down below in accordance with Circular 14/592 dated 30 September 2014 when using collateral to mitigate counterparty risk. As long as collateralization of OTC derivatives transactions is not legally binding the level of collateral required is in the discretion of the portfolio manager of each Sub Fund.

The risk exposure to a counterparty arising from OTC derivatives and efficient portfolio management techniques should be combined when calculating the counterparty risk limits of 3 a) to d).

All assets received by the Sub-Funds in the context of efficient portfolio management techniques should be considered as collateral and should comply with the criteria laid down below:

- a) Liquidity: any collateral other than cash should be highly liquid and traded on a regulated market or multilateral trading facility with transparent pricing in order that it can be sold quickly at a price that is close to its pre-sale valuation. Collateral received should also comply with the provisions set out in

3. l). If the market value of the collateral exceeds or fall short of the contractually agreed threshold, the collateral will be adjusted on a daily basis as to maintain the agreed threshold. This monitoring process is on a daily basis.

- b) Valuation: collateral received should be valued on at least a daily basis and assets that exhibit high price volatility should not be accepted as collateral unless suitably conservative haircuts are in place.
- c) Issuer credit quality: collateral should be of high quality.
- d) Duration: Debt Securities received as collateral should have a maturity equivalent to the maturity of the Debt Securities which may be acquired for the respective Sub-Fund according to its investment restrictions.
- e) Correlation: collateral received must be issued by an entity that is independent from the counterparty and is expected not to display a high correlation with the performance of the counterparty.
- f) Collateral diversification (asset concentration): collateral must be sufficiently diversified in terms of country, markets and issuers. The criterion of sufficient diversification with respect to issuer concentration is considered to be respected if the Sub-Fund receives from a counterparty of efficient portfolio management and OTC derivatives a basket of collateral with a maximum exposure to a given issuer of 20% of the Fund's Net Asset Value. When a Fund is exposed to different counterparties, the different baskets of collateral should be aggregated to calculate the 20% limit of exposure to a single issuer. By way of derogation from this sub-paragraph, a Sub-Fund may be fully collateralised in different transferable securities and money market instruments issued or guaranteed by an EU Member State, one or more of its local authorities, a third country, or a public international body to which one or more EU Member States belong. Such a Sub-Fund should receive securities from at least six different issues, but securities from any single issue should not account for more than 30% of the Sub-Fund's Net Asset Value. A Sub-Fund's individual Investment Restrictions will mention whether such Sub-Fund intends to be fully collateralised in securities issued or guaranteed by an EU Member State.
- g) Enforceable: collateral received should be capable of being fully enforced by the Sub-Fund at any time without reference to or approval from the counterparty.
- h) Non-cash collateral cannot be sold, pledged or re-invested.
- i) Cash collateral received should only be
 - held in accordance with 1. C); or
 - invested in high-quality government bonds; or
 - short term money market funds as defined in the Guidelines on a Common Definition of European Money Market Funds.

Re-invested cash collateral should be diversified in accordance with the diversification requirements applicable to non-cash collateral. Re-investment of cash collateral does not release the Sub-Fund from repayment of full cash collateral received, i.e., potential losses incurring from the re-investment have to be borne by the Sub-Fund.

Risks linked to the management of collateral, such as loss in value or illiquidity of received collateral operational and legal risks, should be identified, managed and mitigated by the risk management process. The re-investment of cash collateral exposes to the Sub-Fund to a potential loss of the re-invested assets whereas the full nominal amount (plus interest if applicable) has to be repaid to the counterparty.

Where there is a title transfer, the collateral received should be held by the Depositary. For other types of collateral arrangement, the collateral can be held by a third-party depositary which is subject to prudential supervision, and which is unrelated to the provider of the collateral.

If a Sub-Fund receives collateral for at least 30% of its Net Asset Value an appropriate stress testing policy will be applied to ensure regular stress tests are carried out under normal and exceptional liquidity conditions to enable the Sub-Fund to assess the liquidity risk attached to the collateral. The liquidity stress testing policy should at least prescribe the following:

- a) design of stress test scenario analysis including calibration, certification and sensitivity analysis,

- b) empirical approach to impact assessment, including back-testing of liquidity risk estimates,
- c) reporting frequency and limit/loss tolerance threshold(s), and
- d) mitigation actions to reduce loss including haircut policy and gap risk protection.

The Company has a clear haircut policy adapted for each class of assets received as collateral. The haircut is a percentage by which the market value of the collateral will be reduced. The Company typically deducts the haircuts from the market value in order to protect against credit, interest rate, foreign exchange and liquidity risk during the period between collateral calls. The haircut generally is contingent on factors such as price volatility of the relevant asset class, the prospective time to liquidate the asset, the maturity of the asset, and the creditworthiness of the issuer. The following minimum haircut levels are applied for the respective each asset class:

Cash (no haircut); Debt Securities issued by governments, central bank and/or supranationals with Investment Grade rating (minimum haircut of 0.5% of the market value); other Debt Securities issued by corporates with Investment Grade rating (minimum haircut of 2% of the market value); Debt Securities as High Yield Investment Type 2 (minimum haircut of 10% of the market value); Equities (minimum haircut of 6% of the market value).

A more volatile (whether because of longer duration or other factors), less liquid asset typically carries a higher haircut. Haircuts are defined with the approval of the risk management function and may be subject to changes depending on changing market conditions. Haircuts may differ depending on the underlying transaction type. Generally, Equities will only be accepted as collateral if they are included in major stock indices. Additional (additive) haircuts apply for Debt Securities with a remaining maturity of more than ten years. Additional (additive) haircuts apply for cash or securities received as collateral in which their currency differ from the base currency of the Sub-Fund.

14. Risk Management Process

The Management Company will calculate the global exposure of each Sub-Fund. The Management Company will use for each Sub-Fund either the commitment approach, the relative Value-at-Risk approach or the absolute Value-at-Risk approach. The applied risk management approach for each Sub-Fund is set out in Appendix 4.

The Management Company may adopt the commitment approach to limit market risk in respect of certain Sub-Funds. The commitment approach measures the global exposure related solely to positions on financial derivative instruments which are converted into equivalent positions on the underlying assets with the Management Company's total commitment to financial derivative instruments being limited to 100% of the portfolio's total net value after taking into account the possible effects of netting and coverage.

For those Sub-Funds for which the relative Value-at-Risk approach is used, the respective reference portfolio is additionally outlined in Appendix 4. Furthermore, for Sub-Funds which either use the relative Value-at-Risk approach or the absolute Value-at-Risk approach, the expected level of leverage of derivatives is disclosed in Appendix 4.

The expected level of leverage of derivatives of the Sub-Fund is expressed as a ratio between the aggregate of the notional values of all derivatives (excluding non-derivative investments) entered into by the Sub-Fund and the NAV calculated based on the fair market value of all investments (including derivatives). The actual level of leverage of the Sub-Fund might change over time and might temporarily exceed the expected level of leverage of derivatives of the Sub-Fund. Derivatives might be used for different purposes including hedging and/or investment purposes. The calculation of the expected level of leverage does not distinguish between the different purposes of a derivative. Therefore, this figure delivers no indication regarding the true riskiness of the Sub-Fund.

15. Transactions with Affiliated Companies

The Company, on behalf of a Sub-Fund, may also enter into transactions and invest in currencies and other instruments for which affiliated companies act as broker or acts on its own account or for account of the customers. This also applies for cases in which affiliated companies, or their customers execute transactions in line with those of the Company. The Company may also enter into mutual transactions, on behalf of a Sub-Fund, in which affiliated companies act both in the name of the Company and

simultaneously in the name of the participating counterparty. In such cases, the affiliated companies have a special responsibility towards both parties. The affiliated companies may also develop or issue derivative instruments for which the underlying securities, currencies or instruments can be the investments in which the Company invests or that are based on the performance of a Sub-Fund. The Company may acquire investments that were either issued by affiliated companies or that are the object of an offer for subscription or other sale of these shares. The commissions and sales charges charged by the affiliated companies should be appropriate.

The Board may impose additional investment restrictions if these are necessary to comply with the legal and administrative provisions in countries in which the Shares of the Company are offered for sale or sold.

16. Securities pursuant to Rule 144A of the United States Securities Act of 1933

To the extent permitted under the laws and regulations of Luxembourg, (and subject to the investment objectives and investment policy of the Sub-Funds), a Sub-Fund may invest in securities which are not registered pursuant to the United States Securities Act of 1933 and amendments thereto (hereinafter called "the 1933 Act"), but which may be sold according to Rule 144A of the 1933 Act to qualified institutional buyers ("securities pursuant to Rule 144A") that qualify as securities as defined under section 1. A) above. A Sub-Fund may invest up to 10% of its net assets in securities pursuant to Rule 144A that do not qualify as securities as defined under section 1. A) above, provided that the total value of such assets together with other such securities and money market instruments that do not fall under section 1. A) above, does not exceed 10%.

17. Direct Investments in Russian Securities

If the investment objective and investment policy of a Sub-Fund allow investment in Russian securities, direct investments in traded Russian securities may be made on the "MICEX-RTS" (Moscow Interbank Currency Exchange – Russian Trade System") which is a Regulated Market for the purposes of Article 41 Paragraph 1 of the Law.

18. General Exclusion of certain issuers

All Sub-Funds refrain from direct investing in securities of issuers which, in the opinion of the Board, engage in undesirable business activities. Undesirable business activities comprise particularly of the following:

- Certain controversial weapons: The type of controversial weapons which are in the scope of the exclusion policy may be updated from time to time and can be consulted on the website https://regulatory.allianzgi.com/ESG/Exclusion_Policy.
- Coal: Issuers engaged in business activities related to coal will only be in scope of the exclusion policy if they meet certain quantitative criteria. Such criteria may be updated from time to time and can be consulted on the website https://regulatory.allianzgi.com/ESG/Exclusion_Policy.

The exclusion policy applies to corporate issuers only. The Sub-Funds might invest in securities baskets such as indices which can contain securities falling under aforementioned exclusion criteria. To undertake this exclusion, various external data and research providers are used. Debt Securities of issuers which are in scope of the exclusion policy may be kept until the earlier of either maturity of the respective instrument or 30 June 2022 provided such instrument has been acquired on behalf of the respective Sub-Fund prior the enforcement of the exclusion policy.

19. Management Approach and reference to a Benchmark

Sub-Funds may or may not be managed by the Investment Manager in reference to a benchmark or an index (the "Benchmark") pursuant to Article 7 Section 1 letter d) of Commission Regulation (EU) No. 583/2010. A Sub-Fund which is managed in reference to a Benchmark makes reference to the relevant Benchmark in its individual investment restrictions in Appendix 1, Part B.

Active Management approach

A Sub-Fund managed in reference to a Benchmark is a Sub-Fund where a Benchmark plays either a role for (i) the explicit or implicit definition of a Sub-Fund's portfolio composition and/or is used for (ii) a Sub-Fund's performance objectives and measures.

A Sub-Fund's Benchmark which is used for the explicit or implicit definition of a Sub-Fund's portfolio composition (the "Portfolio Composition") may include the following cases:

- A Sub-Fund uses a Benchmark as a universe from which to select securities. This applies even if only a minority of securities which are constituents of the Benchmark are held in a Sub-Fund's portfolio and the weightings of a Sub-Fund's portfolio holdings diverge from their equivalent weighting in the Benchmark.
- A Sub-Fund's holdings are based upon the holdings of the Benchmark index. For example:
 - o The individual holdings of the Sub-Fund's portfolio do not deviate materially from those of the Benchmark.
 - o Monitoring systems are in place to limit the extent to which portfolio holdings and/or weightings diverge from the composition of the Benchmark.
- A Sub-Fund invests in units of other UCITS or UCI in order to achieve similar performance to a Benchmark.

A Sub-Fund's Benchmark which is used for a Sub-Fund's performance objectives and measures (the "Performance Measures") may include the following cases:

- A Sub-Fund has an internal or external target to outperform a Benchmark.
- Performance fees are calculated based on performance against a reference benchmark index.
- Contracts between the Management Company and third parties, such as the Investment Managers or Investment Advisors, or between the management company and its directors and employees, state that the portfolio manager must seek to outperform a benchmark index.
- The individual portfolio manager(s) receive(s) an element of performance-related remuneration based on the Sub-Fund's performance relative to a Benchmark.
- A Sub-Fund is constrained by internal or external risk indicators that refer to a Benchmark (e.g., tracking error limit, relative VaR for global exposure calculation).
- Marketing issued by the Management Company to one or more investors or potential investors shows the performance of a Sub-Fund compared with a Benchmark.

In both cases - a Benchmark is used for Portfolio Composition, or a Benchmark is used for Performance Measures - the Sub-Fund's Investment Managers always follow, unless otherwise stated in a Sub-Fund's Investment Restrictions (Appendix 1, Part B), an active management approach, i.e., the composition of a Benchmark is neither replicated nor reproduced.

In both cases, the Investment Manager's aim is to outperform the Benchmark.

A Sub-Fund's Benchmark is used for Performance Measures unless it is explicitly referred to in a Sub-Fund's individual investment restrictions in Appendix 1, Part B, that the relevant Sub-Fund's Benchmark is not used for Performance Measures. If a Sub-Fund's Benchmark should additionally be used for a Sub-Fund's Portfolio Composition, such case is explicitly referred to in a Sub-Fund's individual investment restrictions in Appendix 1, Part B.

Due to the active management approach, a Sub-Fund's Investment Manager may on its sole discretion decide not to acquire certain securities as included in the Benchmark or to acquire securities other than those included in the Benchmark. The composition and weighting of Sub-Fund's assets is neither based on the Benchmark nor on any other benchmark.

Due to the active management approach, the individual performance of a Sub-Fund and the performance of the Sub-Fund's respective Benchmark are expected to differ.

Degree of Freedom

The extent to which an Investment Manager may deviate from the composition of the Benchmark by considering both qualitative and quantitative aspects is referred to as "Degree of Freedom". A Sub-Fund's Degree of Freedom is referred to in a Sub-Fund's individual investment restrictions in Appendix 1, Part B.

The Degree of Freedom describes the grade of activity of the active management approach as used by a Sub-Fund's investment manager. The Degree of Freedom therefore defines the portfolio management's scope of action to deviate from the Benchmark and is classified in the following three categories which reflect the grade of deviation:

- (i) limited,
- (ii) material and
- (iii) significant.

The Degree of Freedom is based on a methodology which is based on a qualitative assessment of the investment strategy as well as various indicators for the grade of activity of the portfolio manager such as active share, tracking error or condensation factor for the equity portion of portfolios or the active factor exposure or deviation in risk contribution from active selection for the fixed income portion of portfolios. Where possible, the indicators are determined on an ex-post basis. As an example, a high tracking error is reflected in the methodology as an indicator for a higher grade of active management.

Sub-Funds with a limited Degree of Freedom have – compared to other actively managed Sub-Funds – a relatively low freedom to deviate from the Benchmark. The deviation of the Sub-Fund's portfolio and the Benchmark composition is usually lower than for Sub-Funds with a material or significant Degree of Freedom. Limited Degree of Freedom can be caused by a Benchmark which is well reflecting the investment strategy of the respective Sub-Fund, e.g., by significant similarity of investment universe of the Sub-Fund and its respective Benchmark. Limited Degree of Freedom can also be caused by a Sub-Fund's Investment Manager being subject to certain requirements and/or restrictions regarding the possible deviation of the composition of the portfolio from the Sub-Fund's Benchmark. As a consequence, the performance of such Sub-Fund and the performance of such Sub-Fund's Benchmark usually differ less significant compared to Sub-Funds with a material or significant Degree of Freedom.

Sub-Funds with a material Degree of Freedom have – compared to other actively managed Sub-Funds with limited Degree of Freedom – a relatively high discretion of the portfolio manager to deviate from the benchmark e.g., through active security selection, active asset allocation and/or active risk management. The deviation of the Sub-Fund's portfolio and the Benchmark composition is usually higher than for Sub-Funds with a limited Degree of Freedom but lower than for Sub-Funds with a significant Degree of Freedom. As a consequence, the performance of such Sub-Fund and the performance of the Benchmark may usually differ more compared to Sub-Funds with a limited Degree of Freedom but may usually differ less compared to Sub-Funds with a significant Degree of Freedom.

Sub-Funds with a significant Degree of Freedom have – compared to other actively managed Sub-Funds with limited or material Degree of Freedom – the relatively highest discretion of the portfolio manager to deviate from the benchmark e.g., unconstrained portfolios with widely defined investment guidelines, including but not limited to higher degrees of leverage, highly concentrated portfolios or thematic funds. The deviation of the Sub-Fund's portfolio and the Benchmark composition is usually higher than for Sub-Funds with a limited or material Degree of Freedom. As a consequence, the performance of such Sub-Fund and the performance of the Benchmark may usually differ more compared to Sub-Funds with a limited or material Degree of Freedom.

The classification of the Degree of Freedom as well as investment restrictions restricting the Degree of Freedom (if any) are referred to in a Sub-Fund's individual investment restrictions in Appendix 1, Part B.

The broadness of the Benchmark's universe can have an influence on the deviation between the Sub-Fund's portfolio and the Benchmark composition. For the various Sub-Funds, a variety of Benchmarks is used which range from benchmarks with a narrow investment universe such as country or sector specific benchmarks (e.g., the DAX which consists of only 30 constituents) with a very broad investment universe without a specification on certain countries or sectors (e.g., the MSCI World All Countries which usually consists of more than 3,000 constituents). Usually, Sub-Funds with a narrower benchmark may deviate less from its benchmark compared to Sub-Funds with a wider benchmark.

The majority of securities held by a Sub-Fund may or may not consist of constituents of the respective Benchmark. It is referred to in a Sub-Fund's individual investment restrictions in Appendix 1, Part B if a Sub-Fund's securities usually have a majority of constituents of the respective Benchmark (mentioned as "Expected Overlap: major") or not (mentioned as "Expected Overlap: minor").

Certain benchmarks, e.g., interest rates or fixed percentages, do not consist of assets which could be acquired by a Sub-Fund, i.e., are not replicable by nature. If a Benchmark – due to its nature – is not replicable in the portfolio of a Sub-Fund (e.g., the respective Benchmark is an interest rate or a fixed percentage), the Expected Overlap is referred to as "not applicable" in the Sub-Fund's individual investment restrictions in Appendix 1, Part B.

The Degree of Freedom to deviate from the Benchmark Index is likely to limit the extent to which a Sub-Fund can outperform or underperform the Benchmark.

The Degree of Freedom as well as the Expected Overlap will be reviewed by the Management Company on a regular basis. Amendments of the Degree of Freedom or the Expected Overlap will be only updated in the next available version of the prospectus. There is no further obligation to inform the shareholders about amendments of the Degree of Freedom or the Expected Overlap except the amendments of the Degree of Freedom or the Expected Overlap are caused by a repositioning of a Sub-Fund.

In case a Sub-Fund's Share Class is hedged against a certain currency, the respective Benchmark is also hedged in the respective currency. In case a Sub-Fund's Benchmark is an interest rate (e.g., EURO SHORT-TERM RATE (€STR)) a hedged Share Class of such Sub-Fund may use an adequate other interest rate of the hedging currency with an adequate tenure.

Part B: Introduction, Sub-Fund's specific Asset Class Principles and Sub-Funds' individual Investment Objectives and Investment Restrictions

Introduction

When studying this prospectus investors should take into account that the individual investment policy of a single Sub-Fund is only revealed in the interplay of various surveys and/or presentations contained in this prospectus. The general fundamentals of the investment policy of all Sub-Funds are described in Appendix 1, Part A, Chapter "General Investment Principles applicable to all Sub-Funds" (the "General Investment Principles"), which define the legal framework for UCITS, with regard to all instruments which are generally eligible for all Sub-Funds (including certain legal limits and restrictions to be observed).

The investments of a Sub-Fund therefor may basically consist of such assets and/or instruments as mentioned in the "General Investment Principles", whereby there may also be additional restrictions to be found in the specific Sub-Fund's Asset Class Principles and a Sub-Fund's individual investment restrictions (Appendix 1, Part B).

Any investment restrictions applicable for all Sub-Funds may also be found in the "General Investment Principles". There may also be additional individual investment restrictions described in the specific Sub-Fund's Asset Class Principles and Investment Restrictions of the respective Sub-Funds, or – if permitted by law – there may be exceptions to the investment restrictions set forth in the "General Investment Principles". In addition, the ability of a Sub-Fund to borrow is limited in accordance with the "General Investment Principles".

A Sub-Fund's specific Asset Class Principles and a Sub-Fund's individual investment objectives and investment restrictions are described in Appendix 1, Part B, where – unless otherwise stated – Appendix 1 Part A and Appendix 4 (Risk Management Process) continues to apply.

Depending on which type of a particular Sub-Fund is concerned, the fundamentals of a Sub-Fund's specific Asset Class Principles are generally applicable for a Sub-Fund's investment policy of such Asset Class. All Sub-Funds associated with a specific Asset Class are listed in alphabetical order under the respective Asset Class.

Appendix 1 Part B differentiates between six Asset Classes and its Principles for

- (i) Equity Funds,
- (ii) Bond Funds,
- (iii) Multi Asset Funds,
- (iv) Funds of Funds,
- (v) Target Maturity Funds, and
- (vi) Alternative Funds.

If a Sub-Fund's individual investment policy differs from the investment principles as set out in the General Investment Principles in combination with a Sub-Fund's specific Asset Class Principles, such deviation is explicitly mentioned in Sub-Fund's individual Investment Restrictions.

The combination of the investment principles resulting from both, the General Investment Principles and the Sub-Fund's specific Asset Class Principles and any potential deviation set out in a Sub-Fund's individual Investment Restrictions determines the individual investment policy of the specific Sub-Fund.

Generally, all Sub-Funds may use techniques and instruments in accordance with the "General Investment Principles" if not otherwise stated in a Sub-Fund's individual Investment Restrictions.

Details on Fees and Expenses are set out in Appendix 2, Sub-Fund specific characteristics (such as the Base Currency, the Dealing Day / Valuation Day convention, and the Trading Deadline applicable) are set out in Appendix 3. The applied risk management approach for each Sub-Fund is set out in Appendix 4. The Investment Managers, if any, as well as the Sub-Funds for which the Management Company does not delegate investment management but performs this duty internally is disclosed in Appendix 5. The

respective Investor Profile as well as investor restrictions (such as specific minimum subscription amounts per Sub-Fund and/or Share Class) are set out in Appendix 6.

Sub-Fund Investments in other Funds

Should a Sub-Fund's specific Asset Class Principles in combination with a Sub-Fund's individual Investment Restrictions provide for investments in other funds, the following shall apply:

- Equity funds in which investments are made may either be broadly diversified equity funds or funds specialising in particular countries, regions or sectors. Any UCITS or UCI is an equity fund if its risk profile typically correlates with that of one or more equity markets.
- Bond funds in which investments are made may either be broadly diversified bond funds or funds specialising in particular countries, regions or sectors, or oriented towards specific maturities or currencies. Any UCITS or UCI is a bond fund if its risk profile typically correlates with that of one or more bond markets.
- Alternative funds in which investments are made typically correlate with alternative investment markets and/or alternative investment strategies whereas the alternative fund's risk profile typically does not or only low correlate with those of standard asset classes as a result of the use of derivatives and the use of appropriate strategies. Alternative funds include investment funds, but are not limited to, which can in particular pursue so-called "equity long / short strategies", "event-driven strategies" and "alternative volatility strategies".
- Money-market funds in which investments are made may either be broadly diversified money-market funds or money-market funds focused on specific groups of issuers or oriented towards specific maturities or currencies. Any UCITS or UCI is a money-market fund as defined above if its risk profile correlates with that of one or more money markets.

In so far as a Sub-Fund's specific Asset Class Principles in combination with a Sub-Fund's Investment Restrictions contain no provisions to the contrary, in principle shares shall preferably be acquired in funds that are managed, directly or indirectly, by the Management Company itself or by any other company with which the Management Company is linked by a substantial direct or indirect participation. Nevertheless, each Sub-Fund is generally allowed to invest a substantial proportion of its assets in UCITS and/or UCI from other companies besides the Management Company.

Passive Violation of Limits

Exceeding or falling below limitations contained in the Sub-Fund's specific Asset Class Principles in combination with a Sub-Fund's individual Investment Restrictions, is permitted if this occurs through changes in the value of assets held in the Sub-Fund, through the exercise of subscription or option rights and/or through change in the value of the Sub-Fund as a whole, in connection with the issue or redemption of share certificates and/or due to changes to the list of excluded issuers analysed by data providers based on the exclusion criteria applicable for a specific investment strategy (so-called "passive violation of limits"). In such cases, the Investment Manager will seek to re-adhere to those limits within an appropriate time frame.

Use of Techniques and Instruments

The Management Company may use techniques and instruments in relation to the Sub-Funds for the purpose of efficient portfolio management (including for hedging purposes) (in accordance with the "General Investment Principles").

Under no circumstances may the Sub-Funds deviate from their stated investment objectives when using such techniques and instruments.

Possible Effects of the Use of Derivatives on the Risk Profile of the Sub-Fund

All Sub-Funds may use derivatives – such as futures, options, and swaps – for hedging purposes. This may lead to correspondingly lower opportunities and risks in the general Sub-Fund profile. Hedging can be used in particular to reflect the different currency-hedged Share Classes and thus to mark the profile of the respective Share Class.

The Sub-Funds may also employ derivatives in a speculative sense in order to increase returns in pursuing the investment objective, in particular, to represent the general Sub-Funds' profiles and to increase the level of investment above the level of investment of a fund that is fully invested in securities. In reflecting the general Sub-Funds' profiles through derivatives, the general Sub-Funds' profiles will be implemented through the replacement of direct investments in securities, for example, by investments in derivatives or also, in shaping the general Sub-Funds' profiles, specific components of the Sub-Funds' investment objectives and principles may be derivative based, for example reflecting currency positions through investments in derivatives, which normally will not have a substantial effect on the general Sub-Funds' profiles. In particular, if a Sub-Fund's investment objective states that, with the objective of achieving additional returns, the Investment Managers may also assume separate foreign currency risks with regard to certain currencies and/or separate risks with regard to equities, bonds and/or commodity futures indices and/or precious metals indices and/or commodity indices these components of the investment objectives and principles are predominantly derivative based.

If the Sub-Funds employ derivatives to increase the level of investment (use of derivatives for investment purposes), they do so in order to achieve a medium to long-term risk profile that offers potentially much greater market risk than that of a fund with a similar profile that does not invest in derivatives.

Sub-Funds' Investment Managers always follow a risk-controlled approach in the use of derivatives.

Sub-Funds' Ability to Exceed or Fall below Specified Investment Limits

All Sub-Funds have the ability to exceed or fall below specified limits by acquiring or selling corresponding assets if it is simultaneously ensured, through the use of techniques and instruments, that the respective market risk potential as a whole adheres to these limits, unless otherwise stated in the respective Sub-Fund's individual Investment Restrictions.

For this purpose, the techniques and instruments are taken into account with the delta-weighted value of the respective underlyings in the manner prescribed. Market-contrary techniques and instruments are considered to reduce risk even when their underlyings and the assets of the Sub-Funds are not precisely matched.

For the case that techniques and instruments are exclusively used for the purpose of the management and/or hedging of a Sub-Fund's Duration, certain government bond forwards and government bond futures (using e.g., US Treasuries, gilts, Bundesanleihen as underlying) are excluded from the respective exposure calculation as following:

- For the calculation of minimum exposure limits, long government bond forwards and long government bond futures shall be included into, and short government bond forwards and short government bond futures shall be excluded from the respective exposure calculation.
- For the calculation of maximum exposure limits, long government bond forwards and long government bond futures shall be excluded from, and short government bond forwards and short government bond futures shall be included into the respective exposure calculation.

Liquidity

Should the specific Asset Class Principles of a Sub-Fund in combination with the individual Investment Restrictions of a Sub-Fund provide that the purpose of Deposits, money-market instruments and/or money-market funds is to ensure the necessary liquidity of the Sub-Fund (liquidity management), these instruments are not used for purposes of implementing the strategic orientation of the Sub-Fund. In this case, their purpose is in particular to fulfil the obligations of the Sub-Fund (e.g., for payment of the Subscription Price or to service redemptions of Shares) and to provide collateral or margin in the framework of the use of techniques and instruments. Any collateral or margin provided are not included in any specific liquidity limit in regard to investments in Deposits, money-market instruments and/or money-market funds provided by the Sub-Fund's specific Asset Class Principles in combination with a Sub-Fund's individual Investment Restrictions.

Potential use of a specific Investment Strategy

As explained under Appendix 1, Part A (General Investment Principles) a Sub-Fund's Investment Manager may select securities based on fundamental and/or quantitative analysis (including, but not limited to, new statistical techniques such as machine learning, natural language processing, and/or artificial intelligence ("AI") as described under Appendix 1, Part A). In this process, individual securities are analysed, assessed, and selected in accordance with different investment processes and/or different investment strategies. For all processes it applies that a Sub-Fund's Investment Manager is always and solely responsible for the final decisions made in the context to analyse, to assess and to select individual securities.

A Sub-Fund's Investment Manager may use one or more of the following individual investment strategies (the "Sustainable Investment Strategy") in making investment decisions for a Sub-Fund:

- Climate Engagement with Outcome Strategy - CEWO
- ESG Score Strategy
- Green Bond Strategy
- Green Transition Strategy
- Multi Asset Sustainability Strategy - MAS Strategy
- SDG-Aligned Strategy
- SDG-Aligned Strategy Type A
- Sustainability Key Performance Indicator Strategy (Absolute Threshold) - KPI Strategy (Absolute Threshold)
- Sustainability Key Performance Indicator Strategy (Absolute) - KPI Strategy (Absolute)
- Sustainability Key Performance Indicator Strategy (Relative) - KPI Strategy (Relative)
- Sustainable and Responsible Investment Strategy - SRI Strategy
- Sustainable and Responsible Investment Strategy Type A - SRI Strategy Type A

The scope, the details, and the relevant requirements (including, but not limited to the applicable exclusion criteria) of each individual Sustainable Investment Strategy as applied by a Sub-Fund's Investment Manager which is either carried out in accordance with Article 8 or with Article 9 SFDR are described in a Sub-Fund's pre-contractual templates which might be found in the attachment to this Prospectus.

In addition, a Sub-Fund's pre-contractual template details the content of the disclosures required under the SFDR, including any taxonomy-related information needed for sub-funds pursuant to Article 8 and Article 9 SFDR.

Insofar as the use of derivatives is involved in the application of an individual Sustainable Investment Strategy, Appendix 1 Part A ("General Investment Principles") No. 6 ("Use of Techniques and Instruments") fully applies. This includes transactions with derivatives for efficient portfolio management (including hedging) and/or investment purposes.

For the case that a Sustainable Investment Strategy is explicitly applied by a Sub-Fund's Investment Manager, the name of the respective Sustainable Investment Strategy is referred to in a Sub-Fund's individual Investment Restrictions by stating that the respective Sustainable Investment Strategy (including its individual exclusion criteria) does apply.

If a Sub-Fund's Investment Manager applies a Sustainable Investment Strategy and also does manage the Sub-Fund in reference to a Benchmark, such Benchmark is not consistent with the environmental or social characteristics promoted by the Sub-Fund or aligned with the Sub-Fund's sustainable Investment Objective, unless specified in a Sub-Fund's individual Investment Restrictions. For such case a Sub-Fund's individual Investment Restrictions explain to what extent the Benchmark is consistent with the environmental or social characteristics promoted by the Sub-Fund or is aligned with the Sub-Fund's sustainable Investment Objective.

1. Equity Funds

The principles set out in the “General Part” are supplemented by the following principles and limits which exclusively apply to all Equity Sub-Funds unless otherwise stated in an Equity Sub-Fund’s individual Investment Restrictions:

- A Sub-Fund’s Investment Manager follows, unless otherwise stated in a Sub-Fund’s investment objective (or in the investment restriction), always an active management approach (as mentioned in Appendix 1, Part A, No. 19).
- Min. 70% of Sub-Fund assets are invested in Equities as described in the investment objective.
- Less than 30% of Sub-Fund assets may be invested in Equities other than described in the investment objective.
- Max. 15% of Sub-Fund assets may be invested in convertible debt securities, thereof max. 10% of Sub-Fund assets may be invested in contingent convertible bonds.
- Max. 25% of Sub-Fund assets may be held directly in time deposits and/or (up to 20% of Sub-Fund assets) in deposits at sight and/or invested in Money Market Instruments and/or (up to 10% of Sub-Fund assets) in money market funds for liquidity management.
- Max. 10% of Sub-Fund assets may be invested in UCITS and/or UCI.
- Where a country and/or region is referred to in the investment objective (or in the investment restriction), a Sub-Fund will (or will not) make investments which have exposure or connection to such country and/or region. Such investments include Equities of companies listed on a Regulated Market or incorporated, with a registered office or principal place of business, or that generate a material share of sales or profits in such country and/or region, as well as companies under common management or control of, or have substantial direct or indirect participation in, the foregoing companies.
- A Benchmark is always used for a Sub-Fund’s Performance Measures if not otherwise referred to in the Sub-Fund’s individual investment restrictions. A Benchmark may be used also for a Sub-Fund’s Portfolio Composition, where such case is explicitly referred to in the Sub-Fund’s individual investment restrictions. In both cases the Investment Manager’s aim is to outperform the Benchmark. A Sub-Fund’s Benchmark (and in the case that such Benchmark is explicitly used for a Sub-Fund’s Portfolio Composition), and the Investment Manager’s Degree of Freedom to deviate from the Benchmark and the expected overlap between the Sub-Fund’s invested securities and the constituents of its Benchmark are referred to, unless not applicable, in a Sub-Fund’s individual Investment Restrictions. (Please refer to Appendix 1, Part A, No. 19)

Allianz All China Equity

Investment Objective

Long-term capital growth by investing in onshore and offshore PRC, Hong Kong, and Macau equity markets in accordance with the ESG Score Strategy.

In this context, the aim is to outperform the Sub-Fund’s weighted average ESG score compared to weighted average ESG score of Sub-Fund’s Benchmark to achieve the investment objective.

Investment Restrictions

- ESG Score Strategy (including exclusion criteria) applies. Sub-Fund’s pre-contractual template describes all relevant information about the strategy’s scope, details, and requirements and applied exclusion criteria.
- Min. 80% of Sub-Fund’s portfolio shall be evaluated by ESG Scores. Portfolio in this respect does not comprise derivatives and instruments that are non-evaluated by nature (e.g., cash and deposits).
- Sub-Fund’s investment objective shall be achieved by an outperformance of Sub-Fund’s weighted average ESG score compared to weighted average ESG Score of Sub-Fund’s Benchmark.
- Sub-Fund assets may be invested in Emerging Markets
- Max. 100% of Sub-Fund assets may be invested into the China A-Shares market
- Max. 69% of Sub-Fund assets may be invested via FII Program
- Hong Kong Restriction applies
- Malaysian Investment Restriction applies
- GITA Restriction (Alternative 1) applies, however at least 70% of Sub-Fund assets are invested in Equity Participation according to Art. 2 Sec. 8 GITA
- VAG Investment Restriction applies
- Benchmark: MSCI China All Shares Total Return Net. Degree of Freedom: material. Expected Overlap: major

Allianz Asian Small Cap Equity

Investment Objective

Long-term capital growth by investing in Asian equity markets excluding Japan, with a focus on small-sized companies.

Investment Restrictions

- Small-sized companies means companies whose market capitalization is a maximum of 1.3 times the market capitalization of the largest security in the MSCI AC Asia Excl. Japan Small Cap.
- Sub-Fund assets may be invested in Emerging Markets
- Max. 30% of Sub-Fund assets may be invested into the China A-Shares market
- Max. 15% of Sub-Fund assets may be invested in convertible debt securities and/or (up to 10% of Sub-Fund assets) in contingent convertible bonds, thereof max. 10% of Sub-Fund assets may be High Yield Investments Type 1

- GITA Restriction (Alternative 1) applies, however at least 70% of Sub-Fund assets are invested in Equity Participation according to Art. 2 Sec. 8 GITA
- VAG Investment Restriction applies
- Benchmark: MSCI AC Asia Excl. Japan Small Cap Total Return Net. Degree of Freedom: significant. Expected Overlap: minor

Allianz Best Styles Euroland Equity

Investment Objective

Long-term capital growth by investing in developed Eurozone equity markets. The Investment Manager may engage in foreign currency overlay and thus assume separate foreign currency risks with regard to currencies of OECD member states, even if the Sub-Fund does not include any assets denominated in these respective currencies.

Investment Restrictions

- Max. 30% of Sub-Fund assets may be invested in Emerging Markets
- Hong Kong Restriction applies
- GITA Restriction (Alternative 1) applies, however at least 70% of Sub-Fund assets are invested in Equity Participation according to Art. 2 Sec. 8 GITA
- VAG Investment Restriction applies
- Benchmark: MSCI EMU Total Return Net. Degree of Freedom: material. Expected Overlap: major

Allianz Best Styles Europe Equity

Investment Objective

Long-term capital growth by investing in European equity markets. The Investment Manager may engage in foreign currency overlay and thus assume separate foreign currency risks with regard to currencies of OECD member states, even if the Sub-Fund does not include any assets denominated in these respective currencies.

Investment Restrictions

- Max. 30% of Sub-Fund assets may be invested in Emerging Markets
- Hong Kong Restriction applies
- GITA Restriction (Alternative 1) applies, however at least 70% of Sub-Fund assets are invested in Equity Participation according to Art. 2 Sec. 8 GITA
- VAG Investment Restriction applies
- Benchmark: MSCI Europe Total Return Net. Degree of Freedom: material. Expected Overlap: major

Allianz Best Styles Europe Equity SRI

Investment Objective

Long-term capital growth by investing in European Equity Markets in accordance with the Sustainable and Responsible Investment Strategy (SRI Strategy). The Investment Manager may engage in foreign currency overlay and thus assume separate foreign currency risks with regard to currencies of OECD member states, even if the Sub-Fund does not include any assets denominated in these respective currencies.

Investment Restrictions

- Max. 30% of Sub-Fund assets may be invested in Equities other than described in the investment objective in accordance with the SRI Strategy
- Max. 30% of Sub-Fund assets may be invested in Emerging Markets
- SRI Strategy (including exclusion criteria) applies. Sub-Fund's pre-contractual template describes all relevant information about the strategy's scope, details, and requirements and applied exclusion criteria.
- Min. 90% of Sub-Fund portfolio shall be evaluated by an SRI Rating. Portfolio in this respect does not comprise non-rated derivatives and instruments that are non-rated by nature (e.g., cash and Deposits).
- Min. 20% of Sub-Fund's investment universe is considered to be non-investable (i.e., will be excluded) based on SRI Rating
- GITA Restriction (Alternative 1) applies, however at least 70% of Sub-Fund assets are invested in Equity Participation according to Art. 2 Sec. 8 GITA
- VAG Investment Restriction applies
- Benchmark: MSCI Europe Ext. SRI 5% Issuer Capped Total Return Net. Degree of Freedom: material. Expected Overlap: major
- Benchmark is not completely consistent with the environmental or social characteristics promoted by the Sub-Fund. Both, Sub-Fund and Benchmark use a combination of SRI screening and exclusion of controversial sectors and violations of UN Global Compact. Benchmark's specific screening and exclusion criteria deviate from the Sub-Fund's investment strategy. Details of the Benchmark's methodology may be found at www.msci.com.

Allianz Best Styles Global AC Equity

Investment Objective

Long-term capital growth by investing in global equity markets.

Investment Restrictions

- Max. 40% of Sub-Fund assets may be invested in Emerging Markets
- Max. 10% of Sub-Fund assets may be invested into the China A-Shares market
- Sub-Fund assets may not be invested in Equities of companies of the tobacco sector
- Hong Kong Restriction applies
- GITA Restriction (Alternative 1) applies, however at least 70% of Sub-Fund assets are invested in Equity Participation according to Art. 2 Sec. 8 GITA
- VAG Investment Restriction applies
- Benchmark: MSCI AC World (ACWI) Total Return Net. Degree of Freedom: material. Expected Overlap: major

Allianz Best Styles Global Equity

Investment Objective

Long-term capital growth by investing in global equity markets.

Investment Restrictions

- Max. 5% of Sub-Fund assets may be invested in Emerging Markets
- Hong Kong Restriction applies
- Taiwan Restriction applies
- GITA Restriction (Alternative 1) applies, however at least 70% of Sub-Fund assets are invested in Equity Participation according to Art. 2 Sec. 8 GITA
- VAG Investment Restriction applies
- Benchmark: MSCI World Total Return Net. Degree of Freedom: material. Expected Overlap: major

Allianz Best Styles Global Equity SRI

Investment Objective

Long-term capital growth by investing in global Equity Markets in accordance with the Sustainable and Responsible Investment Strategy (SRI Strategy).

Investment Restrictions

- Max. 30% of Sub-Fund assets may be invested in Emerging Markets
- SRI Strategy (including exclusion criteria) applies. Sub-Fund's pre-contractual template describes all relevant information about the strategy's scope, details, and requirements and applied exclusion criteria.
- Min. 90% of Sub-Fund portfolio shall be evaluated by an SRI Rating. Portfolio in this respect does not comprise non-rated derivatives and instruments that are non-rated by nature (e.g., cash and Deposits).
- Min. 20% of Sub-Fund's investment universe is considered to be non-investable (i.e., will be excluded) based on SRI Rating
- GITA Restriction (Alternative 1) applies, however at least 70% of Sub-Fund assets are invested in Equity Participation according to Art. 2 Sec. 8 GITA
- VAG Investment Restriction applies
- Benchmark: MSCI World Ext. SRI 5% Issuer Capped Total Return Net. Degree of Freedom: material. Expected Overlap: major
- Benchmark is not completely consistent with the environmental or social characteristics promoted by the Sub-Fund. Both, Sub-Fund and Benchmark use a combination of SRI screening and exclusion of controversial sectors and violations of UN Global Compact. Benchmark's specific screening and exclusion criteria deviate from the Sub-Fund's investment strategy. Details of the Benchmark's methodology may be found at www.msci.com.

Allianz Best Styles Pacific Equity

Investment Objective

Long-term capital growth by investing in Pacific Equity Markets which are Australia, PRC, Japan, New Zealand, Singapore and Hong Kong. The Investment Manager may engage in foreign currency overlay and thus assume separate foreign currency risks with regard to currencies of OECD member states, even if the Sub-Fund does not include any assets denominated in these respective currencies.

Investment Restrictions

- Sub-Fund assets may be invested in Emerging Markets
- Hong Kong Restriction applies
- VAG Investment Restriction applies
- GITA Restriction (Alternative 1) applies, however at least 70% of Sub-Fund assets are invested in Equity Participation according to Art. 2 Sec. 8 GITA
- Benchmark: MSCI Pacific Total Return Net. Degree of Freedom: material. Expected Overlap: major

Allianz Best Styles US Equity

Investment Objective

Long-term capital growth by investing in US equity markets in accordance with the Sustainable and Responsible Investment Strategy (SRI Strategy). The Investment Manager may engage in foreign currency overlay and thus assume separate foreign currency risks with regard to currencies of OECD member states, even if the Sub-Fund does not include any assets denominated in these respective currencies.

Investment Restrictions

- Max. 30% of Sub-Fund assets may be invested in Emerging Markets
- SRI Strategy (including exclusion criteria) applies. Sub-Fund's pre-contractual template describes all relevant information about the strategy's scope, details, and requirements and applied exclusion criteria.
- Min. 90% of Sub-Fund portfolio shall be evaluated by an SRI Rating. Portfolio in this respect does not comprise non-rated derivatives and instruments that are non-rated by nature (e.g., cash and Deposits).
- Min. 20% of Sub-Fund's investment universe is considered to be non-investable (i.e., will be excluded) based on SRI Rating
- Hong Kong Restriction applies
- Taiwan Restriction applies
- VAG Investment Restriction applies
- GITA Restriction (Alternative 1) applies, however at least 70% of Sub-Fund assets are invested in Equity Participation according to Art. 2 Sec. 8 GITA
- Benchmark: S&P 500 Total Return Net. Degree of Freedom: material. Expected Overlap: major

Allianz Blockchain Opportunities

Investment Objective

Long-term capital growth by investing in global Equity Markets with a focus on companies whose business will benefit from or is currently related to the adoption and application of blockchain technology.

Investment Restrictions

- A blockchain is a distributed database or ledger that is shared among the nodes of a computer network. As a database, a blockchain stores information electronically decentralized in digital format. Companies whose business will benefit or is currently related to the adoption and application of blockchain technology will or currently have exposure and/or connections, among others, to digital assets, physical supply chains, specialized semiconductors, consumer goods, web technologies, payment infrastructure, financial services, blockchain enabled systems, social networks, gaming, and virtual environments.
- Sub-Fund assets may be invested in Emerging Markets
- Max. 20% of Sub-Fund assets may be invested into the China A-Shares and/or China B-Shares markets
- Hong Kong Restriction applies
- Taiwan Restriction applies
- VAG Investment Restriction applies
- GITA Restriction (Alternative 1) applies, however at least 70% of Sub-Fund assets are invested in Equity Participation according to Art. 2 Sec. 8 GITA
- Benchmark: 50% MSCI ACWI SMID Cap Net Total Return USD Index + 50% Nasdaq Blockchain Economy Net Total Return Index. Degree of Freedom: significant. Expected Overlap: major

Allianz China A Opportunities

Investment Objective

Long-term capital growth by investing in China A-Shares Equity Markets of the PRC with a focus on large capitalization companies in accordance with the ESG Score Strategy.

In this context, the aim is to outperform the Sub-Fund's weighted average ESG score compared to weighted average ESG score of Sub-Fund's Benchmark to achieve the investment objective.

Investment Restrictions

- ESG Score Strategy (including exclusion criteria) applies. Sub-Fund's pre-contractual template describes all relevant information about the strategy's scope, details, and requirements and applied exclusion criteria.
- Min. 80% of Sub-Fund's portfolio shall be evaluated by ESG Scores. Portfolio in this respect does not comprise derivatives and instruments that are non-evaluated by nature (e.g., cash and deposits).
- Sub-Fund's investment objective shall be achieved by an outperformance of Sub-Fund's weighted average ESG score compared to weighted average ESG Score of Sub-Fund's Benchmark.
- Sub-Fund assets may be invested in Emerging Markets
- Large market capitalization companies mean companies whose market capitalization is at least RMB 30 billion at the time of acquisition
- Max. 69% of Sub-Fund assets may be invested via FII Program
- Max. 20% of Sub-Fund assets may be invested in Equities of PRC Equity Markets other than China A-Shares market (e.g., China B-Shares)
- Max. 10% of Sub-Fund assets may be invested in Equities outside PRC Equity Markets (e.g., China H-Shares)
- Sub-Fund assets may not be invested in convertible debt securities including contingent convertible bonds
- Max. 10% of Sub-Fund assets may be invested in closed-end funds listed on the Shanghai Stock Exchange or Shenzhen Stock Exchange
- Hong Kong Restriction applies
- GITA Restriction (Alternative 1) applies, however at least 70% of Sub-Fund assets are invested in Equity Participation according to Art. 2 Sec. 8 GITA
- VAG Investment Restriction applies
- Benchmark: MSCI China A Total Return Net. Degree of Freedom: material. Expected Overlap: major

Allianz China A-Shares

Investment Objective

Long-term capital growth by investing in China A-Shares equity markets of the PRC in accordance with the ESG Score Strategy.

In this context, the aim is to outperform the Sub-Fund's weighted average ESG score compared to weighted average ESG score of Sub-Fund's Benchmark to achieve the investment objective.

Investment Restrictions

- ESG Score Strategy (including exclusion criteria) applies. Sub-Fund's pre-contractual template describes all relevant information about the strategy's scope, details, and requirements and applied exclusion criteria.
- Min. 80% of Sub-Fund's portfolio shall be evaluated by ESG Scores. Portfolio in this respect does not comprise derivatives and instruments that are non-evaluated by nature (e.g., cash and deposits).
- Sub-Fund's investment objective shall be achieved by an outperformance of Sub-Fund's weighted average ESG score compared to weighted average ESG Score of Sub-Fund's Benchmark.
- Sub-Fund assets may be invested in Emerging Markets
- Max. 69% of Sub-Fund assets may be invested via FII Program
- Max. 20% of Sub-Fund asset may be invested in Equities of PRC markets other than China A-Shares market (e.g., China B-Shares and China H-Shares)
- Max. 10% of Sub-Fund assets may be invested in Equities outside PRC
- Sub-Fund assets may not be invested in convertible debt securities including contingent convertible bonds
- Max. 10% of Sub-Fund assets may be invested in closed end funds listed on the Shanghai Stock Exchange or Shenzhen Stock Exchange.
- Hong Kong Restriction applies
- VAG Investment Restriction applies
- GITA Restriction (Alternative 1) applies, however at least 70% of Sub-Fund assets are invested in Equity Participation according to Art. 2 Sec. 8 GITA
- Benchmark: MSCI China A Onshore Total Return Net. Degree of Freedom: material. Expected Overlap: major

Allianz China Future Technologies

Investment Objective

Long-term capital growth by investing in Equity Markets of the PRC (onshore and offshore), Hong Kong and Macau with a focus on companies with an engagement in the development of future technologies.

Investment Restrictions

- Sub-Fund assets may be invested in Emerging Markets
- Max. 100% of Sub-Fund assets may be invested into the China A-Shares market
- Max. 69% of Sub-Fund assets may be invested via FII Program
- Companies with an engagement in the development of future technologies are companies which offer products, processes or services that provide, or benefit from, advances and improvements in future technologies which may include, but are not limited to, artificial intelligence, communications technology, smart transportation, e-commerce, automation, biotech, green technology, semiconductors, software and financial technology.
- Hong Kong Restriction applies
- VAG Investment Restriction applies
- GITA Restriction (Alternative 1) applies, however at least 70% of Sub-Fund assets are invested in Equity Participation according to Art 2 Sec. 8 GITA
- Benchmark: MSCI China All Shares Total Return Net. Degree of Freedom: significant. Expected Overlap: major

Allianz China Healthy Living

Investment Objective

Long-term capital growth by investing in Equity Markets of the PRC (onshore and offshore), Hong Kong and Macau with a focus on companies with an engagement in the area of healthcare and a healthy lifestyle.

Investment Restrictions

- Sub-Fund assets may be invested in Emerging Markets
- Max. 100% of Sub-Fund assets may be invested in the China A-Shares market
- Max. 69% of Sub-Fund assets may be invested via FII Program
- Companies with an engagement in the areas of healthcare and a healthy lifestyle are companies offering products or solutions that (i) develop medical treatments (including, but not limited to, clinical research, medical devices, hospital services, medicine, to help lessen the symptoms and effects of a disease), (ii) prevent illness (e.g., positive diet, improved environment and lifestyle changes to help reduce the risk of disease), (iii) prolong life / lengthen life span and/or (iv) ensure healthy lives and promote well-being for all ages.
- Hong Kong Restriction applies
- VAG Investment Restriction applies
- GITA Restriction (Alternative 1) applies, however at least 70% of Sub-Fund assets are invested in Equity Participation according to Art 2 Sec. 8 GITA
- Benchmark: MSCI China All Shares Total Return Net. Degree of Freedom: significant. Expected Overlap: major

Allianz China Equity

Investment Objective

Long-term capital growth by investing in the Equity Markets of the PRC, Hong Kong and Macau in accordance with the ESG Score Strategy.

In this context, the aim is to outperform the Sub-Fund's weighted average ESG score compared to weighted average ESG score of Sub-Fund's Benchmark to achieve the investment objective.

Investment Restrictions

- ESG Score Strategy (including exclusion criteria) applies. Sub-Fund's pre-contractual template describes all relevant information about the strategy's scope, details, and requirements and applied exclusion criteria.
- Min. 80% of Sub-Fund's portfolio shall be evaluated by ESG Scores. Portfolio in this respect does not comprise derivatives and instruments that are non-evaluated by nature (e.g., cash and deposits).
- Sub-Fund's investment objective shall be achieved by an outperformance of Sub-Fund's weighted average ESG score compared to weighted average ESG Score of Sub-Fund's Benchmark.
- Sub-Fund assets may be invested in Emerging Markets
- Max. 50% of Sub-Fund assets may be invested into the China A-Shares market
- Hong Kong Restriction applies
- Taiwan Restriction applies
- VAG Investment Restriction applies
- GITA Restriction (Alternative 1) applies, however at least 70% of Sub-Fund assets are invested in Equity Participation according to Art. 2 Sec. 8 GITA
- Benchmark: MSCI China 10/40 Total Return Net. Degree of Freedom: material. Expected Overlap: major

Allianz China Thematica

Investment Objective

Long-term capital growth by investing in Equity Markets of the PRC (onshore and offshore), Hong Kong and Macau with a focus on companies whose business benefits or will benefit from growth opportunities of the PRC in accordance with the ESG Score Strategy.

Investment Restrictions

- ESG Score Strategy (including exclusion criteria) applies. Sub-Fund's pre-contractual template describes all relevant information about the strategy's scope, details, and requirements and applied exclusion criteria.
- Min. 80% of Sub-Fund's portfolio shall be evaluated by ESG Scores. Portfolio in this respect does not comprise derivatives and instruments that are non-evaluated by nature (e.g., cash and deposits).
- Sub-Fund's investment objective shall be achieved by an outperformance of Sub-Fund's weighted average ESG score compared to weighted average ESG Score of Sub-Fund's Benchmark.
- Sub-Fund assets may be invested in Emerging Markets
- Max. 100% of Sub-Fund assets may be invested into the China A-Shares market
- Max. 69% of Sub-Fund assets may be invested via FII Program
- Hong Kong Restriction applies
- VAG Investment Restriction applies
- GITA Restriction (Alternative 1) applies, however at least 70% of Sub-Fund assets are invested in Equity Participation according to Art. 2 Sec. 8 GITA
- Benchmark: MSCI China All Shares Total Return Net. Degree of Freedom: significant. Expected Overlap: major

Allianz Clean Planet

Investment Objective

Long-term capital growth by investing in global Equity Markets with a focus on companies with an engagement in the area of a cleaner environment in accordance with the SDG-Aligned Strategy.

Investment Restrictions

- Min. 70% of Sub-Fund assets are invested in companies with an engagement in the area of a cleaner environment. Companies engaging in the area of a cleaner environment are companies which offer products and/or services with active positive contribution to the improvement of challenges related to three key dimensions of a clean environment which include the core themes (i) clean land, (ii) energy transition, and (iii) clean water as targeted by the SDGs No. 2, 3, 6, 7, 9, 12, 13, 14 and 15.
- Max. 10% of Sub-Fund assets may be invested in convertible debt securities, thereof max. 10% of Sub-Fund assets may be invested in contingent convertible bonds.
- Max. 50% of Sub-Fund assets may be invested in Emerging Markets
- Max. 10% of Sub-Fund assets may be invested into the China A-Shares market
- SDG-Aligned Strategy (including exclusion criteria) applies. Sub-Fund's pre-contractual template describes all relevant information about the strategy's scope, details, and requirements and applied exclusion criteria.
- Hong Kong Restriction applies
- Taiwan Restriction applies
- GITA Restriction (Alternative 1) applies, however at least 70% of Sub-Fund assets are invested in Equity Participation according to Art. 2 Sec. 8 GITA
- Benchmark: MSCI AC World (ACWI) Total Return Net. Degree of Freedom: significant. Expected Overlap: major

Allianz Climate Transition

Investment Objective

Long-term capital growth by investing in European Equity markets with a focus on companies with an engagement in a transition into a low-carbon economy in accordance with the Sustainable and Responsible Investment Strategy (SRI Strategy).

Investment Restrictions

- Companies which engage in the transition into a low-carbon economy are companies which offer products or solutions with active positive contribution to improvement of the supply, efficiency, or quality of a low-carbon economy
- Max. 10% of Sub-Fund assets may be invested in Emerging Markets
- SRI Strategy (including exclusion criteria) applies. Sub-Fund's pre-contractual template describes all relevant information about the strategy's scope, details, and requirements and applied exclusion criteria.
- Min. 90% of Sub-Fund portfolio shall be evaluated by an SRI Rating. Portfolio in this respect does not comprise non-rated derivatives and instruments that are non-rated by nature (e.g., cash and Deposits).
- Min. 20% of Sub-Fund's investment universe is considered to be non-investable (i.e., will be excluded) based on SRI Rating
- GITA Restriction (Alternative 1) applies, however at least 70% of Sub-Fund assets are invested in Equity Participation according to Art. 2 Sec. 8 GITA
- Benchmark: MSCI Europe Total Return Net. Degree of Freedom: material. Expected Overlap: major

Allianz Cyber Security

Investment Objective

Long-term capital growth by investing in the global Equity Markets with a focus on companies whose business will benefit from or is currently related to cyber security in accordance with the Sustainability Key Performance Indicator Strategy (Relative) ("KPI Strategy (Relative)"). In this context, the aim is to outperform the Sub-Fund's Sustainability KPI compared to Sub-Fund's Benchmark to achieve the investment objective.

Investment Restrictions

- Cyber security means companies which have exposure and/or connection to practices defending computers, servers, mobile devices, electronic systems, networks and data against malicious attacks. It also includes the security of information technologies and electronic information. Cyber security includes everything from computer security and disaster recovery to end user training.
- Sub-Fund assets may be invested in Emerging Markets
- Max. 20% of Sub-Fund assets may be invested in the China A-Shares market
- KPI Strategy (Relative) (including exclusion criteria) applies. Sub-Fund's pre-contractual template describes all relevant information about the strategy's scope, details, and requirements and applied exclusion criteria.
- Min. 80% of Sub-Fund's portfolio shall be evaluated by the "Weighted Average GHG Intensity (Sales)" (the "Sustainability KPI"). Portfolio in this respect does not comprise derivatives and instruments that are non-evaluated by nature (e.g., cash and Deposits).
- Sub-Fund's investment objective shall be achieved by a minimum outperformance of 20% of Sub-Fund's Sustainability KPI compared to the Weighted Average GHG Intensity (Sales) of Sub-Fund's Benchmark.
- Hong Kong Restriction applies
- Taiwan Restriction applies
- GITA Restriction (Alternative 1) applies, however at least 70% of Sub-Fund assets are invested in Equity Participation according to Art.2 Sec. 8 GITA
- Benchmark: MSCI AC World (ACWI) Information Technology Total Return Net. Degree of Freedom: significant. Expected Overlap: major

Allianz Emerging Asia Equity

Investment Objective

Long-term capital growth by investing in Equities of Asian Emerging Markets (excluding Japan, Hong Kong and Singapore) and/or of countries which are constituents of the MSCI Emerging Frontier Markets Asia.

Investment Restrictions

- Sub-Fund assets may be invested in Asian Emerging Markets or in countries which are constituents of the MSCI Emerging Frontier Markets Asia
- Max. 30% of Sub-Fund assets may be invested into the China A-Shares market
- Hong Kong Restriction applies
- Taiwan Restriction applies
- VAG Investment Restriction applies
- GITA Restriction (Alternative 1) applies, however at least 70% of Sub-Fund assets are invested in Equity Participation according to Art. 2 Sec. 8 GITA
- Benchmark: MSCI Emerging Frontier Markets Asia Total Return Net. Degree of Freedom: material. Expected Overlap: major

Allianz Emerging Europe Equity

Investment Objective

Long-term capital growth by investing in the European emerging equity markets.

Investment Restrictions

- Min. 70% of Sub-Fund assets are invested in Emerging Markets of Europe or in countries which are constituents of the MSCI EFM Europe + CIS (E+C)
- GITA Restriction (Alternative 1) applies, however at least 51% of Sub-Fund assets are invested in Equity Participation according to Art. 2 Sec. 8 GITA
- Benchmark: MSCI Emerging Markets Europe 10-40 Total Return Net. Degree of Freedom: material. Expected Overlap: major

Allianz Emerging Markets Equity

Investment Objective

Long-term capital growth by investing in emerging equity markets. The Investment Manager may engage in foreign currency overlay and thus assume separate foreign currency risks with regard to currencies of OECD member states, even if the Sub-Fund does not include any assets denominated in these respective currencies.

Investment Restrictions

- Min. 70% of Sub-Fund assets are invested in Emerging Markets or in countries which are constituents of the MSCI Emerging Markets
- Max. 20% of Sub-Fund assets may be held in Deposits and/or invested in Money Market Instruments and/or (up to 10% of Sub-Fund assets) in money market funds
- Max. 20% of Sub-Fund assets may be invested into the China A-Shares market
- Hong Kong Restriction applies
- Taiwan Restriction applies
- GITA Restriction (Alternative 1) applies, however at least 70% of Sub-Fund assets are invested in Equity Participation according to Art. 2 Sec. 8 GITA
- VAG Investment Restriction applies
- Benchmark: MSCI Emerging Markets Total Return Net. Degree of Freedom: material. Expected Overlap: major

Allianz Emerging Markets Equity Opportunities

Investment Objective

Long-term capital growth by investing in emerging equity markets.

Investment Restrictions

- Min. 70% of Sub-Fund assets are invested in at least five Emerging Markets and/ or in at least five countries which are constituents of the MSCI Emerging Markets Daily Total Return Net
- Max. 30% of Sub-Fund assets may be invested into the China A-Shares market
- VAG Investment Restriction applies
- GITA Restriction (Alternative 1) applies, however at least 70% of Sub-Fund assets are invested in Equity Participation according to Art. 2 Sec. 8 GITA
- Benchmark: MSCI Emerging Markets Total Return Net. Degree of Freedom: material. Expected Overlap: major

Allianz Emerging Markets Equity SRI

Investment Objective

Long-term capital growth by investing in Equities of global Emerging Markets in accordance with the Sustainable and Responsible Investment Strategy (SRI Strategy). The Investment Manager may engage in foreign currency overlay and thus assume separate foreign currency risks with regard to currencies of OECD member states, even if the Sub-Fund does not include any assets denominated in these respective currencies.

Investment Restrictions

- Min. 70% of Sub-Fund assets are invested in Emerging Markets or in countries which are constituents of the MSCI Emerging Markets Ext. SRI 5% Issuer Capped.
- Max. 20% of Sub-Fund assets may be held in Deposits and/or invested in Money Market Instruments and/or (up to 10% of Sub-Fund assets) in money market funds
- Max. 30% of Sub-Fund assets may be invested into the China A-Shares market
- SRI Strategy (including exclusion criteria) applies. Sub-Fund's pre-contractual template describes all relevant information about the strategy's scope, details, and requirements and applied exclusion criteria.
- Min. 90% of Sub-Fund portfolio shall be evaluated by an SRI Rating. Portfolio in this respect does not comprise non-rated derivatives and instruments that are non-rated by nature (e.g., cash and Deposits).
- Min. 20% of Sub-Fund's investment universe is considered to be non-investable (i.e., will be excluded) based on SRI Rating
- GITA Restriction (Alternative 1) applies, however at least 70% of Sub-Fund assets are invested in Equity Participation according to Art. 2 Sec. 8 GITA
- VAG Investment Restriction applies
- Benchmark: MSCI Emerging Markets Ext. SRI 5% Issuer Capped Total Return Net. Degree of Freedom: material. Expected Overlap: minor
- Benchmark is not completely consistent with the environmental or social characteristics promoted by the Sub-Fund. Both, Sub-Fund and Benchmark use a combination of SRI screening and exclusion of controversial sectors and violations of UN Global Compact. Benchmark's specific screening and exclusion criteria deviate from the Sub-Fund's investment strategy. Details of the Benchmark's methodology may be found at www.msci.com.

Allianz Enhanced All China Equity

Investment Objective

Long-term capital growth by investing in PRC, Hong Kong and Macau Equity Markets to achieve a diversified portfolio through a combination of fundamental and systematic approaches to stock selection.

Investment Restrictions

- Sub-Fund assets may be invested in Emerging Markets
- Max. 100% of Sub-Fund assets may be invested in the China A-Shares market
- Max. 69% of Sub-Fund assets may be invested via FII Program
- Hong Kong Restriction applies
- GITA Restriction (Alternative 1) applies, however at least 70% of Sub-Fund assets are invested in Equity Participation according to Art. 2 Sec. 8 GITA
- VAG Investment Restriction applies
- Benchmark: MSCI China All Shares Total Return Net. Degree of Freedom: material. Expected Overlap: major

Allianz Euroland Equity Growth

Investment Objective

Long-term capital growth by investing in the Equity Markets of the Eurozone with a focus on growth stocks in accordance with the Sustainability Key Performance Indicator Strategy (Relative) ("KPI Strategy (Relative)"). In this context, the aim is to outperform the Sub-Fund's Sustainability KPI compared to Sub-Fund's Benchmark to achieve the investment objective.

Investment Restrictions

- The Sub-Fund is PEA (Plan d'Épargne en Actions) eligible in France
- Min. 75% of Sub-Fund assets are permanently physically invested in Equities as described in the investment objective
- Max. 25% of Sub-Fund assets may be invested in Equities other than described in the investment objective
- Max. 20% of Sub-Fund assets may be invested in Equities of companies whose registered offices are in countries participating in the Exchange Rate Mechanism II
- Max. 10% of Sub-Fund assets may be invested in Emerging Markets
- Hong Kong Restriction applies
- KPI Strategy (Relative) (including exclusion criteria) applies. Sub-Fund's pre-contractual template describes all relevant information about the strategy's scope, details, and requirements and applied exclusion criteria.
- Min. 80% of Sub-Fund's portfolio shall be evaluated by the "Weighted Average GHG Intensity (Sales)" (the "Sustainability KPI"). Portfolio in this respect does not comprise derivatives and instruments that are non-evaluated by nature (e.g., cash and Deposits).
- Sub-Fund's investment objective shall be achieved by a minimum outperformance of 20% of Sub-Fund's Sustainability KPI compared to the Weighted Average GHG Intensity (Sales) of Sub-Fund's Benchmark.
- Taiwan Restriction applies
- VAG Investment Restriction applies
- GITA Restriction (Alternative 1) applies, however at least 70% of Sub-Fund assets are invested in Equity Participation according to Art. 2 Sec. 8 GITA
- Benchmark: S&P Eurozone Large Mid Cap Growth Total Return Net. Degree of Freedom: material. Expected Overlap: minor

Allianz Europe Equity Growth

Investment Objective

Long-term capital growth by investing in European Equity Markets with a focus on growth stocks in accordance with the Sustainability Key Performance Indicator Strategy (Relative) ("KPI Strategy (Relative)"). In this context, the aim is to outperform the Sub-Fund's Sustainability KPI compared to Sub-Fund's Benchmark to achieve the investment objective.

Investment Restrictions

- Max. 20% of Sub-Fund assets may be invested in Emerging Markets
- KPI Strategy (Relative) (including exclusion criteria) applies. Sub-Fund's pre-contractual template describes all relevant information about the strategy's scope, details, and requirements and applied exclusion criteria.
- Min. 80% of Sub-Fund's portfolio shall be evaluated by the "Weighted Average GHG Intensity (Sales)" (the "Sustainability KPI"). Portfolio in this respect does not comprise derivatives and instruments that are non-evaluated by nature (e.g., cash and Deposits).
- Sub-Fund's investment objective shall be achieved by a minimum outperformance of 20% of Sub-Fund's Sustainability KPI compared to the Weighted Average GHG Intensity (Sales) of Sub-Fund's Benchmark.
- Hong Kong Restriction applies
- VAG Investment Restriction applies
- GITA Restriction (Alternative 1) applies, however at least 70% of Sub-Fund assets are invested in Equity Participation according to Art. 2 Sec. 8 GITA
- Benchmark: S&P Europe Large Mid Cap Growth Total Return Net. Degree of Freedom: material. Expected Overlap: major

Allianz Europe Equity Growth Select

Investment Objective

Long-term capital growth by investing in European Equity Markets with a focus on growth stocks of large market capitalization companies in accordance with the Sustainability Key Performance Indicator Strategy (Relative) ("KPI Strategy (Relative)"). In this context, the aim is to outperform the Sub-Fund's Sustainability KPI compared to Sub-Fund's Benchmark to achieve the investment objective.

Investment Restrictions

- Large market capitalization companies mean companies whose market capitalization is at least EUR 5 billion as determined at the time of acquisition
- Max. 20% of Sub-Fund assets may be invested in Emerging Markets
- KPI Strategy (Relative) (including exclusion criteria) applies. Sub-Fund's pre-contractual template describes all relevant information about the strategy's scope, details, and requirements and applied exclusion criteria.
- Min. 80% of Sub-Fund's portfolio shall be evaluated by the "Weighted Average GHG Intensity (Sales)" (the "Sustainability KPI"). Portfolio in this respect does not comprise derivatives and instruments that are non-evaluated by nature (e.g., cash and Deposits).
- Sub-Fund's investment objective shall be achieved by a minimum outperformance of 20% of Sub-Fund's Sustainability KPI compared to the Weighted Average GHG Intensity (Sales) of Sub-Fund's Benchmark.
- Hong Kong Restriction applies
- Taiwan Restriction applies
- GITA Restriction (Alternative 1) applies, however at least 70% of Sub-Fund assets are invested in Equity Participation according to Art. 2 Sec. 8 GITA
- Benchmark: S&P Europe Large Cap Growth Total Return Net. Degree of Freedom: material. Expected Overlap: major

Allianz Europe Equity powered by Artificial Intelligence

Investment Objective

Long-term capital growth by investing in European Equity Markets. The Investment Manager may engage in foreign currency overlay and thus assume separate foreign currency risks regarding currencies of OECD member states, even if the Sub-Fund does not include any assets denominated in these respective currencies.

Investment Restrictions

- Investment Manager's discretionary decisions are supported using AI according to Appendix 1, Part A ("General Investment Principles")
- Max. 30% of Sub-Fund assets may be invested in Emerging Markets
- VAG Investment Restriction applies
- GITA Restriction (Alternative 1) applies, however at least 70% of Sub-Fund assets are invested in Equity Participation according to Art. 2 Sec. 8 GITA
- Benchmark: MSCI Europe Total Return Net. Degree of Freedom: material. Expected Overlap: minor

Allianz Europe Equity SRI

Investment Objective

Long-term capital growth by investing in European Equity Markets in accordance with the Sustainable and Responsible Investment Strategy (SRI Strategy Type A).

Investment Restrictions

- Investments in the meaning of Appendix 1 Part A No. 2 first indent are not permitted
- SRI Strategy Type A (including exclusion criteria) applies. Sub-Fund's pre-contractual template describes all relevant information about the strategy's scope, details, and requirements and applied exclusion criteria.
- Min. 90% of Sub-Fund portfolio shall be evaluated by an SRI Rating. Portfolio in this respect does not comprise non-rated derivatives and instruments that are non-rated by nature (e.g., cash and Deposits).
- Min. 20% of Sub-Fund's investment universe is considered to be non-investable (i.e., will be excluded) based on SRI Rating
- VAG Investment Restriction applies
- GITA Restriction (Alternative 1) applies, however at least 70% of Sub-Fund assets are invested in Equity Participation according to Art. 2 Sec. 8 GITA
- Benchmark: MSCI Europe Total Return Net. Degree of Freedom: material. Expected Overlap: major

Allianz Europe Equity Value

Investment Objective

Long-term capital growth by investing in European Equity Markets with a focus on value stocks in accordance with the Sustainability Key Performance Indicator Strategy (Relative) ("KPI Strategy (Relative)"). In this context, the aim is to outperform the Sub-Fund's Sustainability KPI compared to Sub-Fund's Benchmark to achieve the investment objective.

Investment Restrictions

- Max. 20% of Sub-Fund assets may be invested in Emerging Markets
- KPI Strategy (Relative) (including exclusion criteria) applies. Sub-Fund's pre-contractual template describes all relevant information about the strategy's scope, details, and requirements and applied exclusion criteria.
- Min. 80% of Sub-Fund's portfolio shall be evaluated by the "Weighted Average GHG Intensity (Sales)" (the "Sustainability KPI"). Portfolio in this respect does not comprise derivatives and instruments that are non-evaluated by nature (e.g., cash and Deposits).
- Sub-Fund's investment objective shall be achieved by a minimum outperformance of 20% of Sub-Fund's Sustainability KPI compared to the Weighted Average GHG Intensity (Sales) of Sub-Fund's Benchmark.
- VAG Investment Restriction applies
- GITA Restriction (Alternative 1) applies, however at least 70% of Sub-Fund assets are invested in Equity Participation according to Art. 2 Sec. 8 GITA
- Benchmark: S&P Europe Large Mid Cap Value Total Return Net. Degree of Freedom: material. Expected Overlap: major

Allianz Europe Mid Cap Equity

Investment Objective

Long-term capital growth by investing in developed European equity markets, excluding Turkey and Russia, with a focus on midsized companies in accordance with the Sustainability Key Performance Indicator Strategy (Absolute Threshold) ("KPI Strategy (Absolute Threshold)"). In this context, the aim is to target a specific minimum allocation into Sustainable Investments to achieve the investment objective.

Investment Restrictions

- Midsized companies mean companies whose market capitalization is a maximum of 1.3 times the market capitalization of the largest security in the MSCI Europe Mid Cap
- Max. 30% of Sub-Fund assets may be invested in Emerging Markets
- Max. 20% of Sub Fund assets may be held in Deposits and/or invested in Money Market Instruments and/or (up to 10% of Sub-Fund assets) in money market funds
- KPI Strategy (Absolute Threshold) (including exclusion criteria) applies. Sub-Fund's pre-contractual template describes all relevant information about the strategy's scope, details, and requirements and applied exclusion criteria.
- VAG Investment Restriction applies
- GITA Restriction (Alternative 1) applies, however at least 70% of Sub-Fund assets are invested in Equity Participation according to Art. 2 Sec. 8 GITA
- Benchmark: MSCI Europe Mid Cap Total Return Net. Degree of Freedom: material. Expected Overlap: major

Allianz Europe Small and Micro Cap Equity

Investment Objective

Long-term capital growth by investing in European equity markets with a focus on micro to small cap companies in accordance with the Sustainability Key Performance Indicator Strategy (Absolute Threshold) ("KPI Strategy (Absolute Threshold)"). In this context, the aim is to target a specific minimum allocation into Sustainable Investments to achieve the investment objective.

Investment Restrictions

- The Sub-Fund is PEA-PME (Plan d'Épargne en Actions destiné au financement des PME et ETI)
- Min. 90% of Sub-Fund assets are invested in Equities in accordance with the investment objective and which fulfill the requirements of PEA-PME
- Micro to small cap companies means companies whose market capitalization is a maximum of 1.3 times the market capitalization of the largest security in the MSCI Europe Small Cap Index
- Max. 10% of Sub-Fund assets may be invested in Equities other than described in the investment objective
- Max. 30% of Sub-Fund assets may be invested in Emerging Markets
- Max. 10% of Sub-Fund assets may be invested in convertible debt securities, and/or in contingent convertible bonds
- Max. 10% of Sub Fund assets may be held directly in Deposits and/or invested in Money Market Instruments and/or in money market funds for liquidity management
- KPI Strategy (Absolute Threshold) (including exclusion criteria) applies. Sub-Fund's pre-contractual template describes all relevant information about the strategy's scope, details, and requirements and applied exclusion criteria.
- GITA Restriction (Alternative 1) applies, however at least 70% of Sub-Fund assets are invested in Equity Participation according to Art. 2 Sec. 8 GITA
- Benchmark: 70% MSCI Europe Small Cap ex-UK Total Return Net + 30% MSCI Europe Micro Cap ex-UK Total Return Net. Degree of Freedom: significant. Expected Overlap: major

Allianz Europe Small Cap Equity

Investment Objective

Long-term capital growth by investing in European Equity Markets with a focus on small-sized companies in accordance with the Sustainability Key Performance Indicator Strategy (Absolute Threshold) ("KPI Strategy (Absolute Threshold)"). In this context, the aim is to target a specific minimum allocation into Sustainable Investments to achieve the investment objective.

Investment Restrictions

- Small-sized companies means companies whose market capitalization is a maximum of 1.3 times the market capitalization of the largest security in the MSCI Europe Small Cap
- Max. 25% of Sub-Fund assets may be invested in Emerging Markets
- Equities, convertible debt securities and/or money market instruments of one and the same issuer may be acquired up to 5% of the Sub-Fund assets
- KPI Strategy (Absolute Threshold) (including exclusion criteria) applies. Sub-Fund's pre-contractual template describes all relevant information about the strategy's scope, details, and requirements and applied exclusion criteria.
- Taiwan Restriction applies
- VAG Investment Restriction applies
- GITA Restriction (Alternative 1) applies, however at least 70% of Sub-Fund assets are invested in Equity Participation according to Art. 2 Sec. 8 GITA
- Benchmark: MSCI Europe Small Cap Total Return Net. Degree of Freedom: material. Expected Overlap: major

Allianz European Equity Dividend

Investment Objective

Long-term capital growth by investing in companies of European Equity Markets that are expected to achieve sustainable dividend returns in accordance with the Sustainability Key Performance Indicator Strategy (Absolute) ("KPI Strategy (Absolute)"). In this context, the aim is, at least, a year-on-year improvement pathway on the Sub-Fund's Sustainability KPI to achieve the investment objective.

Investment Restrictions

- Max. 20% of Sub-Fund assets may be invested in Emerging Markets
- Max. 20% of Sub Fund assets may be held directly in Deposits and/or invested in Money Market Instruments and/or (up to 10% of Sub-Fund assets) in money market funds for liquidity management
- KPI Strategy (Absolute) (including exclusion criteria) applies. Sub-Fund's pre-contractual template describes all relevant information about the strategy's scope, details, and requirements and applied exclusion criteria.
- Min. 80% of Sub-Fund's portfolio shall be evaluated by the "Weighted Average GHG Intensity (Sales)" (the "Sustainability KPI"). Portfolio in this respect does not comprise derivatives and instruments that are non-evaluated by nature (e.g., cash and Deposits).
- Sub-Fund's investment objective shall be achieved by at least a 5% year-on-year improvement pathway at the fiscal year end of the Sub-Fund's Weighted Average GHG Intensity (Sales) starting at the reference date: 29 December 2022. For the period between reference date and the first fiscal year end a pro rata temporis rate of the annual rate will be applied.
- Hong Kong Restriction applies
- Taiwan Restriction applies
- VAG Investment Restriction applies
- GITA Restriction (Alternative 1) applies, however at least 70% of Sub-Fund assets are invested in Equity Participation according to Art. 2 Sec. 8 GITA
- Benchmark: MSCI Europe Total Return Net. Degree of Freedom: material. Expected Overlap: major

Allianz Food Security

Investment Objective

Long-term capital growth by investing in global Equity Markets with a focus on companies with an engagement in the area of food security in accordance with the SDG-Aligned Strategy.

Investment Restrictions

- Min. 70% of Sub-Fund assets are invested in companies with an engagement in the area of food security. Companies which engage in food security are companies which offer products and/or services that improve food management practices across the entire supply chain with the purpose of improving sustainability of the agricultural practices, natural resource efficiency, and affordability and quality of food as targeted by SDGs No. 2, 3, 6, 13, 14 and 15.
- Max. 50% of Sub-Fund assets may be invested in Emerging Markets
- Max. 10% of Sub-Fund assets may be invested in convertible debt securities, and/or in contingent convertible bonds
- Max. 10% of Sub-Fund assets may be invested into the China A-Shares market
- SDG-Aligned Strategy (including exclusion criteria) applies. Sub-Fund's pre-contractual template describes all relevant information about the strategy's scope, details, and requirements and applied exclusion criteria.
- Hong Kong Restriction applies
- Taiwan Restriction applies

- GITA Restriction (Alternative 1) applies, however at least 70% of Sub-Fund assets are invested in Equity Participation according to Art. 2 Sec. 8 GITA
- Benchmark: MSCI AC World (ACWI) Total Return Net. Degree of Freedom: significant. Expected Overlap: major

Allianz GEM Equity High Dividend

Investment Objective

Long-term capital growth by investing in global emerging equity markets with a focus on equities which will result in a portfolio of investments with a potential dividend yield above the market average when the portfolio is considered as a whole

Investment Restrictions

- Min. 70% of Sub-Fund assets are invested in Emerging Markets or in countries which are constituents of the MSCI Emerging Markets
- Max. 30% of Sub-Fund assets may be invested into the China A-Shares market
- Hong Kong Restriction applies
- Taiwan Restriction applies
- VAG Investment Restriction applies
- GITA Restriction (Alternative 1) applies, however at least 70% of Sub-Fund assets are invested in Equity Participation according to Art. 2 Sec. 8 GITA
- Benchmark: MSCI Emerging Markets Total Return Net. Degree of Freedom: material. Expected Overlap: major

Allianz German Equity

Investment Objective

Long-term capital growth by investing in German Equity Markets in accordance with the Sustainability Key Performance Indicator Strategy (Relative) ("KPI Strategy (Relative)"). In this context, the aim is to outperform the Sub-Fund's Sustainability KPI compared to Sub-Fund's Benchmark to achieve the investment objective.

Investment Restrictions

- The Sub-Fund is PEA (Plan d'Épargne en Actions) eligible in France
- Min. 75% of Sub-Fund assets are permanently physically invested in Equities as described in the investment objective
- Max. 25% of Sub-Fund assets may be invested in Equities other than described in the investment objective
- Max. 25% of Sub-Fund assets may be invested in Emerging Markets
- KPI Strategy (Relative) (including exclusion criteria) applies. Sub-Fund's pre-contractual template describes all relevant information about the strategy's scope, details, and requirements and applied exclusion criteria.
- Min. 80% of Sub-Fund's portfolio shall be evaluated by the "Weighted Average GHG Intensity (Sales)" (the "Sustainability KPI"). Portfolio in this respect does not comprise derivatives and instruments that are non-evaluated by nature (e.g., cash and Deposits).
- Sub-Fund's investment objective shall be achieved by a minimum outperformance of 20% of Sub-Fund's Sustainability KPI compared to the Weighted Average GHG Intensity (Sales) of Sub-Fund's Benchmark.
- VAG Investment Restriction applies
- GITA Restriction (Alternative 1) applies, however at least 70% of Sub-Fund assets are invested in Equity Participation according to Art. 2 Sec. 8 GITA
- Benchmark: DAX. Degree of Freedom: material. Expected Overlap: minor

Allianz German Small and Micro Cap

Investment Objective

Long-term capital growth by investing in German equity markets with a focus on micro to small cap companies.

Investment Restrictions

- The Sub-Fund is PEA (Plan d'Épargne en Actions) eligible in France
- Min. 75% of Sub-Fund assets are permanently physically invested in Equities as described in the investment objective.
- Micro to small cap companies means companies whose market capitalisation is a maximum of one time the market capitalisation of the largest security (in terms of market capitalisation) in the SDAX.
- Max. 25% of Sub-Fund assets may be invested in Equities other than described in the investment objective
- Max. 25% of Sub-Fund assets may be invested in Emerging Markets
- VAG Investment Restriction applies
- GITA Restriction (Alternative 1) applies, however at least 70% of Sub-Fund assets are invested in Equity Participation according to Art. 2 Sec. 8 GITA
- Benchmark: SDAX Total Return Gross. Degree of Freedom: material. Expected Overlap: minor

Allianz Global Artificial Intelligence

Investment Objective

Long-term capital growth by investing in the global equity markets with a focus on the evolution of artificial intelligence in accordance with the Sustainability Key Performance Indicator Strategy (Relative) ("KPI Strategy (Relative)"). In this context, the aim is to outperform the Sub-Fund's Sustainability KPI compared to Sub-Fund's Benchmark to achieve the investment objective.

Investment Restrictions

- Sub-Fund assets may be invested in Emerging Markets
- KPI Strategy (Relative) (including exclusion criteria) applies. Sub-Fund's pre-contractual template describes all relevant information about the strategy's scope, details, and requirements and applied exclusion criteria.
- Min. 80% of Sub-Fund's portfolio shall be evaluated by the "Weighted Average GHG Intensity (Sales)" (the "Sustainability KPI"). Portfolio in this respect does not comprise derivatives and instruments that are non-evaluated by nature (e.g., cash and Deposits).
- Sub-Fund's investment objective shall be achieved by a minimum outperformance of 20% of Sub-Fund's Sustainability KPI compared to the Weighted Average GHG Intensity (Sales) of Sub-Fund's Benchmark.
- Hong Kong Restriction applies
- VAG Investment Restriction applies
- GITA Restriction (Alternative 1) applies, however at least 70% of Sub-Fund assets are invested in Equity Participation according to Art. 2 Sec. 8 GITA
- Taiwan Restriction applies
- Benchmark: 50% MSCI AC World (ACWI) Total Return Net + 50% MSCI World Information Technology Total Return Net. Degree of Freedom: significant. Expected Overlap: major

Allianz Global Diversified Dividend

Investment Objective

Long-term capital growth by investing in global Equity Markets in accordance with the Sustainable and Responsible Investment Strategy (SRI Strategy), with a focus on Equities which will result in a portfolio of investments with a potential dividend yield above the market average when the portfolio is considered as a whole.

Investment Restrictions

- Max. 30% of Sub-Fund assets may be invested in Emerging Markets.
- SRI Strategy (including exclusion criteria) applies.
- Min. 90% of Sub-Fund portfolio shall be evaluated by an SRI Rating. Portfolio in this respect does not comprise non-rated derivatives and instruments that are non-rated by nature (e.g., cash and Deposits).
- Hong Kong Restriction applies
- Taiwan Restriction applies
- VAG Investment Restriction applies
- GITA Restriction (Alternative 1) applies, however at least 70% of Sub-Fund assets are invested in Equity Participation according to Art. 2 Sec. 8 GITA
- Benchmark: MSCI World High Dividend Yield Net Return EUR Index. Degree of Freedom: material. Expected Overlap: major

Allianz Global Dividend

Investment Objective

Long-term capital growth by investing in companies of global equity markets that are expected to achieve sustainable dividend payments.

Investment Restrictions

- Max. 30% of Sub-Fund assets may be invested in Emerging Markets
- Max. 10% of Sub-Fund assets may be invested into the China A-Shares market
- Hong Kong Restriction applies
- Taiwan Restriction applies
- VAG Investment Restriction applies
- GITA Restriction (Alternative 1) applies, however at least 70% of Sub-Fund assets are invested in Equity Participation according to Art. 2 Sec. 8 GITA
- Benchmark: MSCI AC World (ACWI) Total Return Net. Degree of Freedom: material. Expected Overlap: major

Allianz Global Emerging Markets Equity Dividend

Investment Objective

Long-term capital growth by investing in companies of emerging equity markets that are expected to achieve sustainable dividend payments.

Investment Restrictions

- Min. 70% of Sub-Fund assets are invested in Emerging Markets or in countries which are constituents of the MSCI Emerging Markets
- Max. 30% of Sub-Fund assets may be invested into the China A-Shares market
- VAG Investment Restriction applies
- GITA Restriction (Alternative 1) applies, however at least 70% of Sub-Fund assets are invested in Equity Participation according to Art. 2 Sec. 8 GITA
- Benchmark: MSCI Emerging Markets Total Return Net. Degree of Freedom: material. Expected Overlap: major

Allianz Global Equity Growth

Investment Objective

Long-term capital growth by investing in global equity markets with a focus on growth stocks in accordance with the Sustainability Key Performance Indicator Strategy (Relative) ("KPI Strategy (Relative)"). In this context, the aim is to outperform the Sub-Fund's Sustainability KPI compared to Sub-Fund's Benchmark to achieve the investment objective.

Investment Restrictions

- Max. 20% of Sub-Fund assets may be invested in Emerging Markets
- Max. 10% of Sub-Fund assets may be invested into the China A-Shares market
- KPI Strategy (Relative) (including exclusion criteria) applies. Sub-Fund's pre-contractual template describes all relevant information about the strategy's scope, details, and requirements and applied exclusion criteria.
- Min. 80% of Sub-Fund's portfolio shall be evaluated by the "Weighted Average GHG Intensity (Sales)" (the "Sustainability KPI"). Portfolio in this respect does not comprise derivatives and instruments that are non-evaluated by nature (e.g., cash and Deposits).
- Sub-Fund's investment objective shall be achieved by a minimum outperformance of 20% of Sub-Fund's Sustainability KPI compared to the Weighted Average GHG Intensity (Sales) of Sub-Fund's Benchmark.
- Hong Kong Restriction applies
- Taiwan Restriction applies
- VAG Investment Restriction applies
- GITA Restriction (Alternative 1) applies, however at least 70% of Sub-Fund assets are invested in Equity Participation according to Art. 2 Sec. 8 GITA
- Benchmark: MSCI AC World (ACWI) Total Return Net. Degree of Freedom: material. Expected Overlap: major

Allianz Global Equity Insights

Investment Objective

Long-term capital growth by investing in global equity markets to achieve a concentrated equity portfolio with a focus on stock selection in accordance with the Sustainability Key Performance Indicator Strategy (Absolute) ("KPI Strategy (Absolute)"). In this context, the aim is, at least, a year-on-year improvement pathway on the Sub-Fund's Sustainability KPI to achieve the investment objective.

Investment Restrictions

- Max. 49% of Sub-Fund assets may be invested in Emerging Markets
- Max. 30% of Sub-Fund assets may be held in Deposits and/or invested in Money Market Instruments and/or (up to 10% of Sub-Fund assets) in money market funds
- Max. 20% of Sub-Fund assets may be invested into the China A-Shares market
- KPI Strategy (Absolute) (including exclusion criteria) applies. Sub-Fund's pre-contractual template describes all relevant information about the strategy's scope, details, and requirements and applied exclusion criteria.
- Min. 80% of Sub-Fund's portfolio shall be evaluated by the "Weighted Average GHG Intensity (Sales)" (the "Sustainability KPI"). Portfolio in this respect does not comprise derivatives and instruments that are non-evaluated by nature (e.g., cash and Deposits).
- Sub-Fund's investment objective shall be achieved by at least a 5% year-on-year improvement pathway at the fiscal year end of the Sub-Fund's Weighted Average GHG Intensity (Sales) starting at the reference date: 29 September 2023. For the period between reference date and the first fiscal year end a pro rata temporis rate of the annual rate will be applied.
- Hong Kong Restriction applies
- VAG Investment Restriction applies
- GITA Restriction (Alternative 1) applies, however at least 70% of Sub-Fund assets are invested in Equity Participation according to Art. 2 Sec. 8 GITA
- Benchmark: MSCI AC World (ACWI) Total Return Net. Degree of Freedom: significant. Expected Overlap: major

Allianz Global Equity powered by Artificial Intelligence

Investment Objective

Long-term capital growth by investing in global Equity Markets. The Investment Manager may engage in foreign currency overlay and thus assume separate foreign currency risks regarding currencies of OECD member states, even if the Sub-Fund does not include any assets denominated in these respective currencies.

Investment Restrictions

- Investment Manager's discretionary decisions are supported using AI according to Appendix 1, Part A ("General Investment Principles")
- Max. 30% of Sub-Fund assets may be invested in Emerging Markets
- VAG Investment Restriction applies
- GITA Restriction (Alternative 1) applies, however at least 70% of Sub-Fund assets are invested in Equity Participation according to Art. 2 Sec. 8 GITA
- Benchmark: MSCI World Total Return Net. Degree of Freedom: material. Expected Overlap: minor

Allianz Global Equity Unconstrained

Investment Objective

Long-term capital growth by investing in global equity markets to achieve a concentrated equity portfolio with a focus on stock selection in accordance with the Sustainability Key Performance Indicator Strategy (Relative) ("KPI Strategy (Relative)"). In this context, the aim is to outperform the Sub-Fund's Sustainability KPI compared to Sub-Fund's Benchmark to achieve the investment objective.

Investment Restrictions

- Min. 70% of Sub-Fund assets are invested in Equities as described in the investment objective, thereof min. 51% of Sub-Fund assets are invested directly in Equities as described in the investment objective
- Max. 50% of Sub-Fund assets may be invested in Emerging Markets
- Max. 15% of Sub-Fund assets may be invested into the China A-Shares market
- KPI Strategy (Relative) (including exclusion criteria) applies. Sub-Fund's pre-contractual template describes all relevant information about the strategy's scope, details, and requirements and applied exclusion criteria.
- Min. 80% of Sub-Fund's portfolio shall be evaluated by the "Weighted Average GHG Intensity (Sales)" (the "Sustainability KPI"). Portfolio in this respect does not comprise derivatives and instruments that are non-evaluated by nature (e.g., cash and Deposits).
- Sub-Fund's investment objective shall be achieved by a minimum outperformance of 20% of Sub-Fund's Sustainability KPI compared to the Weighted Average GHG Intensity (Sales) of Sub-Fund's Benchmark.
- Hong Kong Restriction applies
- VAG Investment Restriction applies
- GITA Restriction (Alternative 1) applies, however at least 70% of Sub-Fund assets are invested in Equity Participation according to Art. 2 Sec. 8 GITA
- Benchmark: MSCI AC World (ACWI) Total Return Net. Degree of Freedom: material. Expected Overlap: major

Allianz Global Hi-Tech Growth

Investment Objective

Long-term capital growth by investing in global equity markets with a focus on the information technology sector or on an industry which forms part of this sector in accordance with the Sustainability Key Performance Indicator Strategy (Absolute) ("KPI Strategy (Absolute)"). In this context, the aim is, at least, a year-on-year improvement pathway on the Sub-Fund's Sustainability KPI to achieve the investment objective.

Investment Restrictions

- Information technology sector means companies that have, or will, develop products, processes or services that will provide, or will benefit significantly from advances and improvements in the information technology sector which includes, but is not limited to, software & related services, including primarily development of software in various fields such as the internet, applications, systems, databases management and/or home entertainment; consulting and services, as well as data processing and outsourced services; technology hardware & equipment, including manufacturers and distributors of communications equipment, computers & peripherals, electronic equipment and related instruments; interactive media & services, internet, internet infrastructure and services; and semiconductors & semiconductor equipment manufacturers.
- Sub-Fund assets may be invested in Emerging Markets
- KPI Strategy (Absolute) (including exclusion criteria) applies. Sub-Fund's pre-contractual template describes all relevant information about the strategy's scope, details, and requirements and applied exclusion criteria.
- Min. 80% of Sub-Fund's portfolio shall be evaluated by the "Weighted Average GHG Intensity (Sales)" (the "Sustainability KPI"). Portfolio in this respect does not comprise derivatives and instruments that are non-evaluated by nature (e.g., cash and Deposits).
- Sub-Fund's investment objective shall be achieved by at least a 5% year-on-year improvement pathway at the fiscal year end of the Sub-Fund's Weighted Average GHG Intensity (Sales) starting at the reference date: 29 September 2023. For the period between reference date and the first fiscal year end a pro rata temporis rate of the annual rate will be applied.
- Hong Kong Restriction applies

- Taiwan Restriction applies
- VAG Investment Restriction applies
- GITA Restriction (Alternative 1) applies, however at least 70% of Sub-Fund assets are invested in Equity Participation according to Art. 2 Sec. 8 GITA
- Benchmark: MSCI World Information Technology Total Return Net. Degree of Freedom: material. Expected Overlap: major

Allianz Global Metals and Mining

Investment Objective

Long-term capital growth by investing in global equity markets with a focus on natural resources. Natural resources may comprise of nonferrous metals, iron and other ores, steel, coal, precious metals, diamonds or industrial salts and minerals.

Investment Restrictions

- Sub-Fund assets may be invested in Emerging Markets
- Max 10% of Sub-Fund Assets may be invested into the China A-Shares market
- Hong Kong Restriction applies
- Taiwan Restriction applies
- VAG Investment Restriction applies
- GITA Restriction (Alternative 1) applies, however at least 70% of Sub-Fund assets are invested in Equity Participation according to Art. 2 Sec. 8 GITA
- Benchmark: MSCI ACWI Metals & Mining 30% Buffer 10/40. Degree of Freedom: material. Expected Overlap: major

Allianz Global Small Cap Equity

Investment Objective

Long-term capital growth by investing in global equity markets with a focus on small-sized companies.

Investment Restrictions

- Small-sized companies means companies whose market capitalisation is a maximum of 1.3 times the market capitalization of the largest security in terms of market capitalization in the MSCI World Small Cap. Under normal market situations the Investment Manager expects to maintain a weighted-average market capitalization of the portfolio of the Sub-Fund between 50% and 200% of the weighted-average market capitalization of the securities in the MSCI World Small Cap.
- Max. 30% of Sub-Fund assets may be invested in Emerging Markets, limited to max. 10% of Sub-Fund assets for each single Emerging Markets country
- Max. 10% of Sub-Fund assets may be invested into the China A-Shares market
- Max. 15% of Sub-Fund assets may be invested in convertible debt securities and/or (up to 10% of Sub-Fund assets) in contingent convertible bonds thereof max. 10% may be invested in High Yield Investments Type I
- Hong Kong Restriction applies
- Taiwan Restriction applies
- VAG Investment Restriction applies
- GITA Restriction (Alternative 1) applies, however at least 70% of Sub-Fund assets are invested in Equity Participation according to Art. 2 Sec. 8 GITA
- Benchmark: MSCI World Small Cap Total Return Net. Degree of Freedom: material. Expected Overlap: major

Allianz Global Sustainability

Investment Objective

Long-term capital growth by investing in global equity markets of developed countries in accordance with the Sustainable and Responsible Investment Strategy (SRI Strategy). The Investment Manager may engage in foreign currency overlay and thus assume separate foreign currency risks with regard to currencies of OECD member states, even if the Sub-Fund does not include any assets denominated in these respective currencies.

Investment Restrictions

- Max. 30% of Sub-Fund assets may be invested in Emerging Markets
- Max. 10% of Sub-Fund assets may be invested into the China A-Shares market
- SRI Strategy (including exclusion criteria) applies. Sub-Fund's pre-contractual template describes all relevant information about the strategy's scope, details, and requirements and applied exclusion criteria.
- Min. 90% of Sub-Fund portfolio shall be evaluated by an SRI Rating. Portfolio in this respect does not comprise non-rated derivatives and instruments that are non-rated by nature (e.g., cash and Deposits).
- Min. 20% of Sub-Fund's investment universe is considered to be non-investable (i.e., will be excluded) based on SRI Rating
- Hong Kong Restriction applies
- Taiwan Restriction applies
- VAG Investment Restriction applies
- GITA Restriction (Alternative 1) applies, however at least 70% of Sub-Fund assets are invested in Equity Participation according to Art. 2 Sec. 8 GITA
- Benchmark: DOW JONES Sustainability World Total Return Net. Degree of Freedom: material. Expected Overlap: minor

- Benchmark is not completely consistent with the environmental or social characteristics promoted by the Sub-Fund. Both, Sub-Fund and Benchmark use a combination of SRI screening and exclusion of controversial sectors and violations of UN Global Compact. Benchmark's specific screening and exclusion criteria deviate from the Sub-Fund's investment strategy. Details of the Benchmark's methodology may be found at www.spglobal.com.

Allianz Global Water

Investment Objective

Long-term capital growth by investing in global Equity Markets with a focus on companies with an engagement in the area of water resource management in accordance with the SDG-Aligned Strategy.

Investment Restrictions

- Min. 70% of Sub-Fund assets are invested in companies with an engagement in the area of water resource management. Companies which engage in the area of water resource management are companies which offer products and/or services that create positive environmental and social outcomes along water scarcity and quality issues and helps to improve the sustainability of global water resources, as targeted by the SDGs No. 2, 3, 6, 11 and 13.
- Max. 10% of Sub-Fund assets may be invested into the China A-Shares market
- Max. 10% of Sub-Fund assets may be invested in convertible debt securities and/or in contingent convertible bonds
- Sub-Fund assets may be invested in Emerging Markets
- SDG-Aligned Strategy (including exclusion criteria) applies. Sub-Fund's pre-contractual template describes all relevant information about the strategy's scope, details, and requirements and applied exclusion criteria.
- Hong Kong Restriction applies
- Taiwan Restriction applies
- VAG Investment Restriction applies
- GITA Restriction (Alternative 1) applies, however at least 70% of Sub-Fund assets are invested in Equity Participation according to Art. 2 Sec. 8 GITA
- Benchmark: MSCI AC World (ACWI) Total Return Net. Degree of Freedom: significant. Expected Overlap: major

Allianz High Dividend Asia Pacific Equity

Investment Objective

Long-term capital growth by investing in a portfolio of Asia Pacific (excluding Japan) equity market securities, with a potential dividend yield above the market average in accordance with the Sustainability Key Performance Indicator Strategy (Relative) ("KPI Strategy (Relative)"). In this context, the aim is to outperform the Sub-Fund's Sustainability KPI compared to Sub-Fund's Benchmark to achieve the investment objective.

Investment Restrictions

- Max. 80% of Sub-Fund assets may be invested in Emerging Markets
- Max. 30% of Sub-Fund assets may be invested into the China A-Shares and/or China B-Shares markets
- KPI Strategy (Relative) (including exclusion criteria) applies. Sub-Fund's pre-contractual template describes all relevant information about the strategy's scope, details, and requirements and applied exclusion criteria.
- Min. 80% of Sub-Fund's portfolio shall be evaluated by the "Weighted Average GHG Intensity (Sales)" (the "Sustainability KPI"). Portfolio in this respect does not comprise derivatives and instruments that are non-evaluated by nature (e.g., cash and Deposits).
- Sub-Fund's investment objective shall be achieved by a minimum outperformance of 20% of Sub-Fund's Sustainability KPI compared to the Weighted Average GHG Intensity (Sales) of Sub-Fund's Benchmark.
- Hong Kong Restriction applies
- Taiwan Restriction applies
- VAG Investment Restriction applies
- GITA Restriction (Alternative 1) applies, however at least 70% of Sub-Fund assets are invested in Equity Participation according to Art. 2 Sec. 8 GITA
- Benchmark: MSCI AC Asia Pacific Excl. Japan Total Return Net. Degree of Freedom: material. Expected Overlap: major

Allianz Hong Kong Equity

Investment Objective

Long-term capital growth by investing in Hong Kong equity markets.

Investment Restrictions

- Max. 30% of Sub-Fund assets may be invested in Emerging Markets
- Max. 30% of Sub-Fund assets may be invested into the China A-Shares market
- Hong Kong Restriction applies
- Taiwan Restriction applies
- VAG Investment Restriction applies
- GITA Restriction (Alternative 1) applies, however at least 70% of Sub-Fund assets are invested in Equity Participation according to Art. 2 Sec. 8 GITA
- Benchmark: FTSE MPF Hong Kong Index Total Return Net. Degree of Freedom: material. Expected Overlap: minor

Allianz India Equity

Investment Objective

Long-term capital growth by investing in equity markets of the Indian Subcontinent, including India, Pakistan, Sri Lanka and Bangladesh.

Investment Restrictions

- Min. 70% of Sub-Fund assets are invested in Equities as described in the investment objective, thereof max. 30% of Sub-Fund assets may be invested in equity markets of Pakistan, Sri Lanka and Bangladesh
- Sub-Fund assets may be invested in Emerging Markets
- Hong Kong Restriction applies
- VAG Investment Restriction applies
- GITA Restriction (Alternative 1) applies, however at least 70% of Sub-Fund assets are invested in Equity Participation according to Art. 2 Sec. 8 GITA
- Benchmark: MSCI India Total Return Net. Degree of Freedom: material. Expected Overlap: major

Allianz Indonesia Equity

Investment Objective

Long-term capital growth by investing in Indonesian equity markets.

Investment Restrictions

- Sub-Fund assets may be invested in Emerging Markets
- Hong Kong Restriction applies
- Taiwan Restriction applies
- VAG Investment Restriction applies
- GITA Restriction (Alternative 1) applies, however at least 70% of Sub-Fund assets are invested in Equity Participation according to Art. 2 Sec. 8 GITA
- Benchmark: JAKARTA Composite. Degree of Freedom: material. Expected Overlap: major

Allianz Japan Equity

Investment Objective

Long-term capital growth by investing in Japanese Equity Markets in accordance with the Sustainability Key Performance Indicator Strategy (Relative) ("KPI Strategy (Relative)"). In this context, the aim is to outperform the Sub-Fund's Sustainability KPI compared to Sub-Fund's Benchmark to achieve the investment objective.

Investment Restrictions

- Max. 30% of Sub-Fund assets may be invested in Emerging Markets
- KPI Strategy (Relative) (including exclusion criteria) applies. Sub-Fund's pre-contractual template describes all relevant information about the strategy's scope, details, and requirements and applied exclusion criteria.
- Min. 80% of Sub-Fund's portfolio shall be evaluated by the "Weighted Average GHG Intensity (Sales)" (the "Sustainability KPI"). Portfolio in this respect does not comprise derivatives and instruments that are non-evaluated by nature (e.g., cash and Deposits).
- Sub-Fund's investment objective shall be achieved by a minimum outperformance of 20% of Sub-Fund's Sustainability KPI compared to the Weighted Average GHG Intensity (Sales) of Sub-Fund's Benchmark.
- Hong Kong Restriction applies
- Taiwan Restriction applies
- VAG Investment Restriction applies
- GITA Restriction (Alternative 1) applies, however at least 70% of Sub-Fund assets are invested in Equity Participation according to Art. 2 Sec. 8 GITA
- Benchmark: TOPIX Total Return Net. Degree of Freedom: material. Expected Overlap: major

Allianz Japan Smaller Companies Equity

Investment Objective

Long-term capital growth by investing in Japanese equity markets with a focus on mid and small-sized companies.

Investment Restrictions

- Mid and small-sized companies mean companies whose market capitalization is a maximum of 2.0 times the market capitalization of the largest security in the MSCI Japan Small Cap Index.
- Max 10% of Sub-Fund assets may be invested in Emerging Markets.
- GITA Restriction (Alternative 1) applies, however at least 70% of Sub-Fund assets are invested in Equity Participation according to Art.2 Sec. 8 GITA
- Benchmark: MSCI Japan Small Cap Total Return Net. Degree of Freedom: material. Expected Overlap: major

Allianz Little Dragons

Investment Objective

Long-term capital growth by investing in Asian equity markets, excluding Japan, with a focus on small-sized and mid-sized companies.

Investment Restrictions

- Small-sized and mid-sized companies means companies whose market capitalization is a maximum of 1.3 times of the market capitalization of the largest security in terms of market capitalisation in the MSCI AC Asia Excl. Japan Mid Cap.
- Sub-Fund assets may be invested in Emerging Markets
- Max. 30% of Sub-Fund assets may be invested into the China A-Shares market
- Hong Kong Restriction applies
- VAG Investment Restriction applies
- GITA Restriction (Alternative 1) applies, however at least 70% of Sub-Fund assets are invested in Equity Participation according to Art. 2 Sec. 8 GITA
- Benchmark: MSCI AC Asia Excl. Japan Mid Cap Total Return Net. Degree of Freedom: material. Expected Overlap: minor

Allianz Metaverse

Investment Objective

Long-term capital growth by investing in global Equity Markets with a focus on companies whose business will benefit from or is currently related to the Metaverse.

Investment Restrictions

- Metaverse is a digital space created by the convergence of the physical world and digital worlds including the sum of all virtual worlds, augmented reality, and the internet. Companies whose business will benefit or is currently related to the Metaverse will or currently have exposure and/or connections, among others, to web technologies, web infrastructure, spatial computing, blockchain enabled systems, decentralised finance, digital world providers, social networks, gaming, and virtual environments.
- Sub-Fund assets may be invested in Emerging Markets
- Max. 20% of Sub-Fund assets may be invested into the China A-Shares and/or China B-Shares markets
- Hong Kong Restriction applies
- VAG Investment Restriction applies
- GITA Restriction (Alternative 1) applies, however at least 70% of Sub-Fund assets are invested in Equity Participation according to Art. 2 Sec. 8 GITA
- Benchmark: 50% MSCI AC World (ACWI) Total Return Net + 50% MSCI AC World (ACWI) Information Technology Total Return Net. Degree of Freedom: significant. Expected Overlap: major

Allianz Pet and Animal Wellbeing

Investment Objective

Long-term capital growth by investing in global equity markets with a focus on the evolution and development of pet and animal wellbeing in accordance with the Sustainability Key Performance Indicator Strategy (Absolute Threshold) ("KPI Strategy (Absolute Threshold)"). In this context, the aim is to target a specific minimum allocation into Sustainable Investments to achieve the investment objective.

Investment Restrictions

- Sub-Fund assets may be invested in Emerging Markets
- Max. 10% of Sub-Fund assets may be invested into the China A-Shares market
- KPI Strategy (Absolute Threshold) (including exclusion criteria) applies. Sub-Fund's pre-contractual template describes all relevant information about the strategy's scope, details, and requirements and applied exclusion criteria.
- Hong Kong Restriction applies
- Taiwan Restriction applies
- GITA Restriction (Alternative 1) applies, however at least 70% of Sub-Fund assets are invested in Equity Participation according to Art. 2 Sec. 8 GITA
- Benchmark: MSCI AC World (ACWI) Total Return Net. Degree of Freedom: significant. Expected Overlap: minor

Allianz Positive Change

Investment Objective

Long-term capital growth by investing in global Equity Markets in accordance with the SDG-Aligned Strategy with a focus on companies with an engagement in one or more United Nations' SDGs, and hence create positive outcomes for environment and society.

Investment Restrictions

- Min. 70% of Sub-Fund assets are invested in companies with an engagement in one or more United Nations' SDGs. Companies with an engagement in one or more SDGs and hence create positive outcomes for environment and society, are companies which offer products and/or services across the themes of affordable healthcare, education, energy transition, food security, financial inclusion, water, and waste management as targeted by the SDGs No. 1, 2, 3, 4, 5, 6, 7, 8, 9, 10, 11, 12, 13, 14, 15, 16 and 17.
- Max. 10% of Sub-Fund assets may be invested in convertible debt securities and/or in contingent convertible bonds
- Max. 50% of Sub-Fund assets may be invested in Emerging Markets
- Max. 10% of Sub-Fund assets may be invested into the China A-Shares market
- SDG-Aligned Strategy (including exclusion criteria) applies. Sub-Fund's pre-contractual template describes all relevant information about the strategy's scope, details, and requirements and applied exclusion criteria.
- Hong Kong Restriction applies
- Taiwan Restriction applies
- GITA Restriction (Alternative 1) applies, however at least 70% of Sub-Fund assets are invested in Equity Participation according to Art. 2 Sec. 8 GITA
- Benchmark: MSCI AC World (ACWI) Total Return Net. Degree of Freedom: significant. Expected Overlap: major

Allianz Premium Champions

Investment Objective

Long-term capital growth by investing in global Equity Markets with a focus on companies that provide premium products and/or services, including those that have a strong competitive position, and/or a strong brand portfolio.

Investment Restrictions

- Max. 20% of Sub-Fund assets may be invested in Emerging Markets
- Max. 10% of Sub-Fund assets may be invested into the China A-Shares market
- Hong Kong Restriction applies
- Malaysian Investment Restriction applies
- Taiwan Restriction applies
- VAG Investment Restriction applies
- GITA Restriction (Alternative 1) applies, however at least 70% of Sub-Fund assets are invested in Equity Participation according to Art. 2 Sec. 8 GITA
- Benchmark: MSCI AC World (ACWI) Total Return Net. Degree of Freedom: significant. Expected Overlap: major

Allianz SDG Global Equity

Investment Objective

Long-term capital growth by investing in global Equity Markets in accordance with the SDG-Aligned Strategy with a focus on companies that contribute to one or more United Nations' SDGs, and hence create positive outcomes for environment and society.

Investment Restrictions

- Min. 70% of Sub-Fund assets shall be invested in companies which offer products and/or services that contribute to one or more of the SDGs No. 1 to No. 17.
- Max. 30% of Sub-Fund assets may be invested in Emerging Markets.
- Max. 10% of Sub-Fund assets may be invested in REITs.
- Max. 10% of Sub-Fund assets may be invested in convertible debt securities and/or in contingent convertible bonds.
- SDG-Aligned Strategy (including exclusion criteria) applies. Sub-Fund's pre-contractual template describes all relevant information about the strategy's scope, details, and requirements and applied exclusion criteria.
- GITA Restriction (Alternative 1) applies, however at least 70% of Sub-Fund assets are invested in Equity Participation according to Art. 2 Sec. 8 GITA
- VAG Investment Restriction: applies
- Benchmark: MSCI World Net Total Return. Degree of Freedom: material. Expected Overlap: minor

Allianz Smart Energy

Investment Objective

Long-term capital growth by investing in global Equity Markets with a focus on companies with an engagement in the area of transition of energy usage in accordance with the SDG-Aligned Strategy.

Investment Restrictions

- Min. 70% of Sub-Fund assets are invested in companies with an engagement in transition of energy usage. Companies which engage in the transition of energy usage are companies which offer products and/or services with active positive contribution to the shift away from fossil fuels, enhancing resilience of the sustainable energy infrastructure, creating renewable sources of energy generation, energy storage systems and improving efficacy and access to energy consumption, as targeted by the SDGs No. 7, 9, 11, 12, and 13.
- Max. 10% of Sub-Fund assets may be invested in convertible debt securities and/or in contingent convertible bonds
- Max. 10% of Sub-Fund assets may be invested into the China A-Shares market
- Sub-Fund assets may be invested in Emerging Markets
- SDG-Aligned Strategy (including exclusion criteria) applies. Sub-Fund's pre-contractual template describes all relevant information about the strategy's scope, details, and requirements and applied exclusion criteria.
- Hong Kong Restriction applies
- Taiwan Restriction applies
- GITA Restriction (Alternative 1) applies, however at least 70% of Sub-Fund assets are invested in Equity Participation according to Art. 2 Sec. 8 GITA
- Benchmark: MSCI AC World (ACWI) Total Return Net. Degree of Freedom: significant. Expected Overlap: major

Allianz Social Conviction Equity

Investment Objective

Long-term capital growth by investing in the Equity Markets of the Eurozone with a focus on companies that have a superior social profile in accordance with the Sustainable and Responsible Investment Strategy (SRI Strategy).

Investment Restrictions

- Companies with a superior social profile are either companies (i) that provide products and/or services that have a positive social contribution (which includes, among other things, health and the welfare of society) and/or (ii) companies that are deemed to exhibit a superior social profile by the investment manager's discretionary assessment by taking into consideration both qualitative and quantitative social indicators.
- SRI Strategy (including exclusion criteria) applies. Sub-Fund's pre-contractual template describes all relevant information about the strategy's scope, details, and requirements and applied exclusion criteria.
- The Sub-Fund is PEA (Plan d'Épargne en Actions) eligible in France
- Min. 75% of Sub-Fund assets are permanently physically invested in Equities as described in the investment objective
- Max. 25% of Sub-Fund assets may be invested in Equities other than described in the investment objective
- Min. 90% of Sub-Fund portfolio shall be evaluated by an SRI Rating. Portfolio in this respect does not comprise non-rated derivatives and instruments that are non-rated by nature (e.g., cash and Deposits).
- Min. 20% of Sub-Fund's investment universe is considered to be non-investable (i.e., will be excluded) based on SRI Rating
- VAG Investment restriction applies.
- GITA Restriction (Alternative 1) applies, however at least 70% of Sub-Fund assets are invested in Equity Participation according to Art. 2 Sec. 8 GITA
- Benchmark: MSCI EMU Total Return Net. Degree of Freedom: material. Expected Overlap: major

Allianz Sustainable Health Evolution

Investment Objective

Long-term capital growth by investing in global Equity Markets with a focus on companies with an engagement in the area of health innovation and promotion in accordance with the SDG-Aligned Strategy.

Investment Restrictions

- Min. 70% of Sub-Fund assets are invested in companies with an engagement in the area of health innovation. Companies which engage in the area of health innovation and promotion are companies offering products and/or services that enable a healthy and sustainable lifestyle through (i) preventing illness (fitness, nutrition and lifestyle changes to help reduce the risk of disease), (ii) prescribing treatment (medicine, therapy, surgery etc. to help lessen the symptoms and effects of a disease) and (iii) prolonging life (technology, tools, research, science etc. to lengthen life span) as targeted by the SDG's No. 2, 3, 6, 11 and 12.
- Max. 50% of Sub-Fund assets may be invested in Emerging Markets
- Max. 10% of Sub-Fund assets may be invested in convertible debt securities and/or in contingent convertible bonds.
- Max. 10% of Sub-Fund assets may be invested into the China A-Shares market
- SDG-Aligned Strategy (including exclusion criteria) applies. Sub-Fund's pre-contractual template describes all relevant information about the strategy's scope, details, and requirements and applied exclusion criteria.
- Hong Kong Restriction applies
- Taiwan Restriction applies
- GITA Restriction (Alternative 1) applies, however at least 70% of Sub-Fund assets are invested in Equity Participation according to Art. 2 Sec. 8 GITA
- Benchmark: MSCI AC World (ACWI) Total Return Net. Degree of Freedom: significant. Expected Overlap: major

Allianz Systematic Enhanced US Equity SRI

Investment Objective

Long-term capital growth by investing in US Equity Markets in accordance with the Sustainable and Responsible Investment Strategy (SRI Strategy). The Investment Manager may engage in foreign currency overlay and thus assume separate foreign currency risks with regard to currencies of OECD member states, even if the Sub-Fund does not include any assets denominated in these respective currencies.

Investment Restrictions

- Max. 10% of Sub-Fund assets may be invested in Emerging Markets
- SRI Strategy (including exclusion criteria) applies. Sub-Fund's pre-contractual template describes all relevant information about the strategy's scope, details, and requirements and applied exclusion criteria.
- Min. 90% of Sub-Fund portfolio shall be evaluated by an SRI Rating. Portfolio in this respect does not comprise non-rated derivatives and instruments that are non-rated by nature (e.g., cash and Deposits).
- Min. 20% of Sub-Fund's investment universe is considered to be non-investable (i.e., will be excluded) based on SRI Rating
- Hong Kong Restriction applies
- Taiwan Restriction applies
- VAG Investment Restriction applies
- GITA Restriction (Alternative 1) applies, however at least 70% of Sub-Fund assets are invested in Equity Participation according to Art. 2 Sec. 8 GITA
- Benchmark: MSCI USA ESG Screened Index. Degree of Freedom: limited (the Investment Manager defines constraints against the Benchmark to achieve a low tracking error and similar return pattern (e.g., constraints on active weight of single stock/sectors). Our deviation from the investment universe, weightings and risk characteristics of the Benchmark is likely to be limited in our own discretion.). Expected Overlap: major
- Benchmark is not completely consistent with the environmental or social characteristics promoted by the Sub-Fund. Both, Sub-Fund and Benchmark use a combination of SRI screening and exclusion of controversial sectors and violations of UN Global Compact. Benchmark's specific screening and exclusion criteria deviate from the Sub-Fund's investment strategy. Details of the Benchmark's methodology may be found at www.msci.com.

Allianz Thematica

Investment Objective

Long-term capital growth by investing in global Equity Markets with a focus on theme and stock selection in accordance with the Sustainability Key Performance Indicator Strategy (Absolute Threshold) ("KPI Strategy (Absolute Threshold)"). In this context, the aim is to target a specific minimum allocation into Sustainable Investments to achieve the investment objective.

Investment Restrictions

- Max. 50% of Sub-Fund assets may be invested in Emerging Markets
- Max. 10% of Sub-Fund assets may be invested in China A-Shares market
- KPI Strategy (Absolute Threshold) (including exclusion criteria) applies. Sub-Fund's pre-contractual template describes all relevant information about the strategy's scope, details, and requirements and applied exclusion criteria.
- Hong Kong Restriction applies
- Malaysian Investment Restriction applies
- Taiwan Restriction applies
- VAG Investment Restriction applies
- GITA Restriction (Alternative 1) applies, however at least 70% of Sub-Fund assets are invested in Equity Participation according to Art. 2 Sec. 8 GITA
- Benchmark: MSCI AC World (ACWI) Total Return Net. Degree of Freedom: significant. Expected Overlap: major

Allianz Total Return Asian Equity

Investment Objective

Long-term capital growth and income by investing in the equity markets of the Republic of Korea, Taiwan, Thailand, Hong Kong, Malaysia, Indonesia, the Philippines, Singapore and/or the PRC in accordance with the Sustainability Key Performance Indicator Strategy (Relative) ("KPI Strategy (Relative)"). In this context, the aim is to outperform the Sub-Fund's Sustainability KPI compared to Sub-Fund's Benchmark to achieve the investment objective.

Investment Restrictions

- Sub-Fund assets may be invested in Emerging Markets
- Max. 30% of Sub-Fund assets may be invested into the China A-Shares market
- Max. 30% of Sub-Fund assets may be held in Deposits and/or invested in Money Market Instruments and/or (up to 10% of Sub-Fund assets) in money market funds
- KPI Strategy (Relative) (including exclusion criteria) applies. Sub-Fund's pre-contractual template describes all relevant information about the strategy's scope, details, and requirements and applied exclusion criteria.
- Min. 80% of Sub-Fund's portfolio shall be evaluated by the "Weighted Average GHG Intensity (Sales)" (the "Sustainability KPI"). Portfolio in this respect does not comprise derivatives and instruments that are non-evaluated by nature (e.g., cash and Deposits).
- Sub-Fund's investment objective shall be achieved by a minimum outperformance of 20% of Sub-Fund's Sustainability KPI compared to the Weighted Average GHG Intensity (Sales) of Sub-Fund's Benchmark.
- Hong Kong Restriction applies
- Taiwan Restriction applies
- VAG Investment Restriction applies
- GITA Restriction (Alternative 1) applies, however at least 70% of Sub-Fund assets are invested in Equity Participation according to Art. 2 Sec. 8 GITA
- Benchmark: MSCI AC Asia Excl. Japan Total Return Net. Degree of Freedom: material. Expected Overlap: major

Allianz US Equity Fund

Investment Objective

Long-term capital growth by investing in companies of US equity markets with a minimum market capitalisation of USD 500 million.

Investment Restrictions

- Max. 30% Sub-Fund assets may be invested in Emerging Markets
- Hong Kong Restriction applies
- VAG Investment Restriction applies
- GITA Restriction (Alternative 1) applies, however at least 70% of Sub-Fund assets are invested in Equity Participation according to Art. 2 Sec. 8 GITA
- Benchmark: S&P 500 Total Return. Degree of Freedom: material. Expected Overlap: major

Allianz US Equity Plus

Investment Objective

Long-term capital growth and income by investing in US equity markets.

Investment Restrictions

- Max. 30% of Sub-Fund assets may be invested in Emerging Markets
- Max. 20% of Sub Fund assets may be held in Deposits and/or invested in Money Market Instruments and/or (up to 10% of Sub-Fund assets) in money market funds
- Max. 20% non-USD Currency Exposure
- Hong Kong Restriction applies
- Taiwan Restriction applies
- VAG Investment Restriction applies
- GITA Restriction (Alternative 1) applies, however at least 70% of Sub-Fund assets are invested in Equity Participation according to Art. 2 Sec. 8 GITA
- Benchmark: none

Allianz US Equity powered by Artificial Intelligence

Investment Objective

Long-term capital growth by investing in US Equity Markets. The Investment Manager may engage in foreign currency overlay and thus assume separate foreign currency risks regarding currencies of OECD member states, even if the Sub-Fund does not include any assets denominated in these respective currencies.

Investment Restrictions

- Investment Manager's discretionary decisions are supported using AI according to Appendix 1, Part A ("General Investment Principles")
- Max. 20% of Sub-Fund assets may be invested in Emerging Markets
- VAG Investment Restriction applies
- GITA Restriction (Alternative 1) applies, however at least 70% of Sub-Fund assets are invested in Equity Participation according to Art. 2 Sec. 8 GITA
- Benchmark: S&P 500 Total Return Net. Degree of Freedom: material. Expected Overlap: minor

Allianz US Large Cap Value

Investment Objective

Long-term capital growth by investing in the US Equity Markets with a focus on value stocks.

Investment Restrictions

- Value stock means Equity whose current share price is trading - for whatever reason - below its intrinsic value.
- Max. 10% of Sub-Fund assets may be invested in Emerging Markets
- Max. 20% non-USD Currency Exposure
- Max. 20% of Sub-Fund assets may be invested in REITs
- Hong Kong Restriction applies
- Taiwan Restriction applies
- VAG Investment Restriction applies
- GITA Restriction (Alternative 1) applies, however at least 70% of Sub-Fund assets are invested in Equity Participation according to Art. 2 Sec. 8 GITA
- Benchmark: Russell 1000 Value Total Return Net. Degree of Freedom: material. Expected Overlap: major

2. Bond Funds

The principles set out in the “General Part” are supplemented by the following principles and limits which exclusively apply to all Bond Sub-Funds unless otherwise stated in a Bond Sub-Fund’s individual Investment Restrictions:

- A Sub-Fund’s Investment Manager follows, unless otherwise stated in a Sub-Fund’s investment objective (or in the investment restriction), always an active management approach (as mentioned in Appendix 1, Part A, No. 19).
- Sub-Fund assets are primarily invested in Debt Securities as described in the investment objective.
- Less than 30% of Sub-Fund assets may be invested in Debt Securities other than described in the investment objective.
- Max. 20% of Sub-Fund assets may be invested in ABS and/or MBS.
- Max. 10% of Sub-Fund assets may be invested in contingent convertible bonds.
- Max. 10% of Sub-Fund assets may be invested in preference shares.
- Max. 10% of Sub-Fund assets may be invested in UCITS and/or UCI.
- Max. 100% of Sub-Fund assets may be held in time deposits and/or (up to 20% of Sub-Fund assets) in deposits at sight and/or invested directly in Money Market Instruments and/or (up to 10% of Sub-Fund assets) in money market funds on a temporary basis for liquidity management and/or defensive purpose and/or any other exceptional circumstances, and if the investment manager considers it in the best interest of the Sub-Fund.
- Where a country, region and/or market is referred to in the investment objective (or in the investment restriction), a Sub-Fund will (or will not) make investments which have exposure or connection to such country, region and/or markets. Such investments include Debt Securities that are issued or guaranteed by governments, municipalities, agencies, supra-nationals, central, regional, or local authority and companies of (including those that generate a predominant share of their sales or their profits in) such country, region and/or market as well as companies that are under common management or control of, or have substantial direct or indirect participation in the foregoing companies.
- Sub-Fund assets may be invested in Equities and comparable securities or rights in the exercise of subscription, conversion and option rights on investments such as convertible bonds, contingent convertible bonds and bonds with warrants, but they must be sold within twelve months from the date of acquisition. Up to 5% of Sub-Fund assets as described in the aforementioned meaning may be invested longer than twelve months if the investment manager considers it in the best interest of the Sub-Fund.
- A Benchmark is always used for a Sub-Fund’s Performance Measures if not otherwise referred to in the Sub-Fund’s individual investment restrictions. A Benchmark may be used also for a Sub-Fund’s Portfolio Composition, where such case is explicitly referred to in the Sub-Fund’s individual investment restrictions. In both cases the Investment Manager’s aim is to outperform the Benchmark. A Sub-Fund’s Benchmark (and in the case that such Benchmark is explicitly used for a Sub-Fund’s Portfolio Composition), and the Investment Manager’s Degree of Freedom to deviate from the Benchmark and the expected overlap between the Sub-Fund’s invested securities and the constituents of its Benchmark are referred to, unless not applicable, in a Sub-Fund’s individual Investment Restrictions. (Please refer to Appendix 1, Part A, No. 19)

Allianz Advanced Fixed Income Euro

Investment Objective

Long-term capital growth above the long-term return of the government bond markets issued within the Eurozone in Euro (EUR) terms by investing in global Bond Markets with Euro exposure in accordance with the Sustainable and Responsible Investment Strategy (SRI Strategy).

Investment Restrictions

- Max. 30% of Sub-Fund assets may be invested in Emerging Markets
- Max. 20% of Sub-Fund assets may be invested in High-Yield Investments Type 1
- Sub-Fund assets may be invested in options and/or future-contracts on equity indices for both, efficient portfolio management and hedging purposes. Sub-Fund assets must not at any time own a net synthetic long position on equity indices
- Max. 20% non-EUR Currency Exposure
- SRI Strategy (including exclusion criteria) applies. Sub-Fund’s pre-contractual template describes all relevant information about the strategy’s scope, details, and requirements and applied exclusion criteria.
- Min. 90% of Sub-Fund portfolio shall be evaluated by an SRI Rating. Portfolio in this respect does not comprise non-rated derivatives and instruments that are non-rated by nature (e.g., cash and Deposits).
- Duration: between 1 and 10 years
- Benchmark: BLOOMBERG Euro Aggregate 1-10 Year Total Return. Degree of Freedom: material. Expected Overlap: major

Allianz Advanced Fixed Income Global

Investment Objective

Long-term capital growth above the return of the global sovereign bond markets by investing in global Bond Markets in accordance with the Sustainable and Responsible Investment Strategy (SRI Strategy).

Investment Restrictions

- Max. 30% of Sub-Fund assets may be invested in Emerging Markets
- Min. 40% of Sub-Fund assets are invested in Debt Securities which are issued or guaranteed by governments, municipalities, agencies, supra-nationals, central, regional or local authority
- Max. 20% of Sub-Fund assets may be invested in High-Yield Investments Type 1
- Sub-Fund assets may be invested in options and/or future-contracts on equity indices for both, efficient portfolio management and hedging purposes. Sub-Fund assets must not at any time own a net synthetic long position on equity indices
- Max. 15% of Sub-Fund assets may be invested in the PRC bond markets
- SRI Strategy (including exclusion criteria) applies. Sub-Fund's pre-contractual template describes all relevant information about the strategy's scope, details, and requirements and applied exclusion criteria.
- Min. 90% of Sub-Fund portfolio shall be evaluated by an SRI Rating. Portfolio in this respect does not comprise non-rated derivatives and instruments that are non-rated by nature (e.g., cash and Deposits).
- Duration: between 3 and 9 years
- Benchmark: J.P. MORGAN Government Bond (GBI) 1-10 Year. Degree of Freedom: material. Expected Overlap: minor

Allianz Advanced Fixed Income Global Aggregate

Investment Objective

Long-term capital growth by investing in global corporate and government Bond Markets in accordance with the Sustainable and Responsible Investment Strategy (SRI Strategy).

Investment Restrictions

- Max. 30% of Sub-Fund assets may be invested in Emerging Markets
- Max. 20% of Sub-Fund assets may be invested in High-Yield Investments Type 2
- Sub-Fund assets may be invested in options and/or future-contracts on equity indices for both, efficient portfolio management and hedging purposes. Sub-Fund assets must not at any time own a net synthetic long position on equity indices
- Max. 20% of Sub-Fund assets may be invested in ABS and/or MBS with Investment Grade
- Max. 15% of Sub-Fund assets may be invested in the PRC bond markets
- SRI Strategy (including exclusion criteria) applies. Sub-Fund's pre-contractual template describes all relevant information about the strategy's scope, details, and requirements and applied exclusion criteria.
- Min. 90% of Sub-Fund portfolio shall be evaluated by an SRI Rating. Portfolio in this respect does not comprise non-rated derivatives and instruments that are non-rated by nature (e.g., cash and Deposits).
- Duration: between 3 and 9 years.
- VAG Investment Restriction applies
- Benchmark: BLOOMBERG Global Aggregate 500 Excl. CNY Total Return. Degree of Freedom: material. Expected Overlap: major

Allianz Advanced Fixed Income Short Duration

Investment Objective

Long-term capital growth above the average long-term return of the short duration European Bond Markets by investing in global Bond Markets with Euro exposure in accordance with the Sustainable and Responsible Investment Strategy (SRI Strategy).

Investment Restrictions

- Max. 25% of Sub-Fund assets may be invested in High-Yield Investments Type 2
- Sub-Fund assets may be invested in options and/or future-contracts on equity indices for both, efficient portfolio management and hedging purposes. Sub-Fund assets must not at any time own a net synthetic long position on equity indices
- Max. 20% of Sub-Fund assets may be invested in Emerging Markets
- Max. 10% of Sub-Fund assets may be invested in ABS and/or MBS with Investment Grade
- Max. 10% non-EUR Currency Exposure
- SRI Strategy (including exclusion criteria) applies. Sub-Fund's pre-contractual template describes all relevant information about the strategy's scope, details, and requirements and applied exclusion criteria.
- Min. 90% of Sub-Fund portfolio shall be evaluated by an SRI Rating. Portfolio in this respect does not comprise non-rated derivatives and instruments that are non-rated by nature (e.g., cash and Deposits)
- Duration: between zero and 4 years
- VAG Investment Restriction applies
- Benchmark: BLOOMBERG Euro Aggregate 1-3 Year Total Return. Degree of Freedom: material. Expected Overlap: minor

Allianz American Income

Investment Objective

Long term capital growth and income by investing in debt securities of American bond markets with a focus on the US bond markets.

Investment Restrictions

- Min. 70% of Sub-Fund assets are invested in Debt Securities from the US.
- Max. 60% of Sub-Fund assets may be invested in High-Yield Investment Type 2
- Max. 30% of Sub-Fund assets may be invested in Emerging Markets
- Max. 30% of Sub-Fund assets may be invested in convertible debt securities
- Max. 20% of Sub-Fund assets may be invested in ABS/MBS with Investment Grade
- Max. 20% non-USD Currency Exposure
- Duration: between 3 and 9 years
- Hong Kong Restriction applies
- Taiwan restriction applies, except for the respective high-yield limit
- Benchmark: none

Allianz China Strategic Bond

Investment Objective

Long term capital growth and income by investing in the PRC, Hong Kong, Taiwan and Macau bond markets.

Investment Restrictions

- Sub-Fund assets may be invested in Emerging Markets
- Max. 100% of Sub-Fund assets may be invested in High-Yield Investments Type 1
- Max. 100% of Sub-Fund assets may be invested in the PRC bond markets, including so called urban investment bonds
- Max. 69% of Sub-Fund assets may be invested via FII Program
- Hong Kong Restriction applies
- Duration: between zero and 10 years
- Benchmark: J.P. MORGAN Asia Credit China Index. Degree of Freedom: significant. Expected Overlap: minor

Allianz Convertible Bond

Investment Objective

Long term capital growth by investing in convertible debt securities of European Bond Markets in accordance with the Sustainability Key Performance Indicator Strategy (Relative) ("KPI Strategy (Relative)"). In this context, the aim is to outperform the Sub-Fund's Sustainability KPI compared to Sub-Fund's Benchmark to achieve the investment objective.

Investment Restrictions

- Min. 60% of Sub-Fund assets are invested in convertible Debt Securities in accordance with the investment objective
- Max. 40% of Sub-Fund assets may be invested in Debt Securities other than described in the investment objective
- Sub-Fund assets may be invested in High-Yield Investments Type 1, however, Sub-Fund assets may be invested in Debt Securities that are only rated CC (Standard & Poor's) or lower (including max. 10% of defaulted securities)
- Max. 40% of Sub-Fund assets may be held in Deposits and be invested in Money Market Instruments and/or (up to 10% of Sub-Fund assets) in money market funds
- Max. 20% of Sub-Fund assets may be invested in Emerging Markets
- Sub-Fund assets may be invested in Equities and comparable securities or rights in the exercise of subscription, conversion and option rights on investments such as convertible debt securities and/or contingent convertible bonds.
- KPI Strategy (Relative) (including exclusion criteria) applies. Sub-Fund's pre-contractual template describes all relevant information about the strategy's scope, details, and requirements and applied exclusion criteria.
- Min. 70% of Sub-Fund's portfolio shall be evaluated by the "Weighted Average GHG Intensity (Sales)" (the "Sustainability KPI"). Portfolio in this respect does not comprise derivatives and instruments that are non-evaluated by nature (e.g., cash and Deposits).
- Sub-Fund's investment objective shall be achieved by an outperformance of Sub-Fund's Sustainability KPI compared to the Weighted Average GHG Intensity (Sales) of Sub-Fund's Benchmark.
- Benchmark: Refinitiv Europe Focus CB (EUR). Degree of Freedom: material. Expected Overlap: major

Allianz Credit Opportunities

Investment Objective

Long term capital growth by investing in global bond markets.

Investment Restrictions

- Sub-Fund assets may be invested in Emerging Markets
- Sub-Fund assets (excluding ABS/MBS) may be invested in High-Yield Investments Type 2
- Max. 10% of Sub-Fund assets may be invested in Equities. Included in this limit are Equities and comparable securities or rights in the exercise of subscription, conversion and option rights on investments such as convertible bonds, contingent convertible bonds and bonds with warrants.
- Max. 10% non-EUR Currency Exposure
- Duration: between minus 1 and 2 years
- VAG Investment Restriction applies
- The Investment Manager focuses on the following types of strategies:
Credit Long / Short strategies
The long / short credit segment encompasses a broad diversity of credit strategies mainly implemented in the corporate bond market, via bonds, derivatives and cash. One common investment strategy is to benefit from price discrepancies between the securities of one or more issuers within the same sector or market segment. Strategies may vary in respect of credit-rating requirements, regional exposure and some may also effort to take advantage of event driven opportunities within the corporate bond market.
- Benchmark: EURO SHORT-TERM RATE (€STR). Degree of Freedom: significant. Expected Overlap: not applicable

Allianz Credit Opportunities Plus

Investment Objective

Superior risk adjusted returns by investing in global bond markets

Investment Restrictions

- Sub-Fund assets may be invested in Emerging Markets
- Sub-Fund assets (excluding ABS/MBS) may be invested in High-Yield Investments Type 1
- Max. 10% of Sub-Fund assets may be invested in Equities. Included in this limit are Equities and comparable securities or rights in the exercise of subscription, conversion and option rights on investments such as convertible bonds, contingent convertible bonds and bonds with warrants.
- Max. 10% non-EUR Currency Exposure
- Duration: between minus 3 and 6 years
- The Investment Manager focuses on the following types of strategies:
Credit Long / Short strategies
The long / short credit segment encompasses a broad diversity of credit strategies mainly implemented in the corporate bond market, via bonds, derivatives and cash. One common investment strategy is to benefit from price discrepancies between the securities of one or more issuers within the same sector or market segment. Strategies may vary in respect of credit-rating requirements, regional exposure and some may also effort to take advantage of event driven opportunities within the corporate bond market.
- Benchmark: EURO SHORT-TERM RATE (€STR). Degree of Freedom: significant. Expected Overlap: not applicable

Allianz Dynamic Asian High Yield Bond

Investment Objective

Long-term capital growth and income by investing in high yield rated Debt Securities of Asian bond markets.

Investment Restrictions

- Sub-Fund assets may be invested in Emerging Markets
- Min. 70% of Sub-Fund assets are invested in High-Yield Investments Type 1 in accordance with the investment objective, however, within this limit max. 10% of Sub-Fund assets may be invested in Debt Securities with a rating of CC (Standard & Poor's) or lower (including defaulted securities)
- Max. 10% of Sub-Fund assets may be invested in convertible Debt Securities
- Max. 20% RMB Currency Exposure
- Max. 30% non-USD Currency Exposure
- Max. 20% of Sub-Fund assets may be invested in the PRC bond markets
- Duration: between zero and 10 years
- Hong Kong Restriction applies
- Taiwan Restriction applies, except for the respective high-yield limit
- Benchmark: J.P. MORGAN JACI Non-Investment Grade Custom Index. Degree of Freedom: material. Expected Overlap: major

Allianz Emerging Markets Select Bond

Investment Objective

Superior risks adjusted returns through a complete market cycle by investing in emerging bond markets.

Investment Restrictions

- Min. 70% of Sub-Fund assets are invested in Debt Securities of Emerging Markets or of countries which are constituents of the J.P. MORGAN Emerging Market Bond (EMBI) Global Diversified or the J.P. MORGAN Corporate Emerging Market Bond or the J.P. MORGAN Government Bond – Emerging Markets (GBI-EM) Global
- Sub-Fund assets may be invested in High-Yield Investments Type 1, however, Sub-Fund assets may be invested in Debt Securities that are only rated CC (Standard & Poor's) or lower (including max. 10% of defaulted securities)
- Max. 15% of Sub-Fund assets may be invested in the PRC bond markets
- Duration: between minus 4 and 8 years
- Hong Kong Restriction applies
- Benchmark: J.P. MORGAN Emerging Markets Blended (JEMB) Equal Weighted Total Return. Degree of Freedom: material. Expected Overlap: major

Allianz Emerging Markets Short Duration Bond

Investment Objective

Long-term capital growth and income by investing in short duration Debt Securities of emerging bond markets denominated in USD.

Investment Restrictions

- Min. 70% of Sub-Fund assets are invested in Debt Securities with a rating of B- (Standard & Poor's) or better of Emerging Markets or of countries which are constituents of the J.P. MORGAN Emerging Market Bond (EMBI) Global Diversified or the J.P. MORGAN Corporate Emerging Market Bond and which are denominated in USD
- Sub-Fund assets may be invested in High-Yield Investments Type 2
- Sub-Fund assets may not be invested in ABS and/or MBS
- Max. 15% of Sub-Fund assets may be invested in the PRC bond markets
- Max. 10% of Sub-Fund assets may be invested in preference shares issued by corporates of an Emerging Market country or of countries which are constituents of the J.P. MORGAN Emerging Market Bond (EMBI) Global Diversified or the J.P. MORGAN Corporate Emerging Market Bond or the J.P. MORGAN Government Bond – Emerging Markets (GBI-EM) Global
- Duration: between 1 and 3 years
- Hong Kong Restriction applies
- VAG Investment Restriction applies
- Benchmark: SECURED OVERNIGHT FINANCING RATE (SOFR). Degree of Freedom: significant. Expected Overlap: not applicable

Allianz Emerging Markets Sovereign Bond

Investment Objective

Long term capital growth by investing in global emerging bond markets

Investment Restrictions

- Min. 70% of the Sub-Fund assets are invested in Debt Securities in accordance with the investment objective or in Debt Securities issued by countries that are constituents of the J.P. MORGAN Emerging Market Bond (EMBI) Global Diversified.
- Max. 30% of the Sub-Fund assets may be invested in corporate Debt Securities. Excluded from this limit are quasi-sovereigns that are owned more than 50% or guaranteed by the national government of an Emerging Market Country or of a country which is a constituent of the J.P. MORGAN Emerging Market Bond (EMBI) Global Diversified.
- Max. 15% of Sub-Fund assets may be invested in the PRC bond markets
- Sub-Fund assets may be invested in High-Yield Investments Type 1, however, Sub-Fund assets may be invested in Debt Securities that are only rated CC (Standard & Poor's) or lower (including max. 10% of defaulted securities)
- Max. 10% of Sub-Fund assets may be invested in convertible debt securities
- Max. 20% non-USD Currency Exposure
- Duration: between 1 and 10 Years
- Benchmark: J.P. MORGAN Emerging Market Bond (EMBI) Global Diversified. Degree of Freedom: material. Expected Overlap: major

Allianz Emerging Markets SRI Bond

Investment Objective

Long term capital growth by investing in sovereign and quasi-sovereign Debt Securities of global Emerging Markets in accordance with the Sustainable and Responsible Investment Strategy (SRI Strategy).

Investment Restrictions

- Min. 70% of Sub-Fund assets are invested in Debt Securities in accordance with the investment objective or which are issued by countries that are constituents of the J.P. MORGAN ESG Emerging Market Bond (EMBI) Global Diversified. Quasi-sovereign Debt Securities are Debt Securities that are owned more than 50% or guaranteed by the national government of an Emerging Market Country or of a country which is a constituent of the J.P. MORGAN ESG Emerging Market Bond (EMBI) Global Diversified.
- Max. 30% of Sub-Fund assets may be invested in Debt Securities other than described in the investment objective.
- Max. 15% of Sub-Fund assets may be invested in the PRC bond markets
- Sub-Fund assets may be invested in High-Yield Investments Type 2
- Max. 20% non-USD Currency Exposure
- SRI Strategy (including exclusion criteria) applies. Sub-Fund's pre-contractual template describes all relevant information about the strategy's scope, details, and requirements and applied exclusion criteria. In addition, the following exclusion criteria apply:
 - For sovereign issuers an internal scoring model weighting various environmental, social and governance factors is applied for which Freedom House Index is considered as one criterion amongst further criteria
- Min. 90% of Sub-Fund portfolio shall be evaluated by an SRI Rating. Portfolio in this respect does not comprise non-rated derivatives and instruments that are non-rated by nature (e.g., cash and Deposits)
- Min. 20% of Sub-Fund's investment universe is considered to be non-investable (i.e., will be excluded) based on SRI Rating
- Duration: between 1 and 10 Years
- Hong Kong Restriction applies
- VAG Investment Restriction applies
- Benchmark: J.P. MORGAN ESG Emerging Market Bond (EMBI) Global Diversified Total Return. Degree of Freedom: material. Expected Overlap: major
- Benchmark is not completely consistent with the environmental or social characteristics promoted by the Sub-Fund. Both, Sub-Fund and Benchmark use a combination of SRI screening and exclusion of controversial sectors and violations of UN Global Compact. Benchmark's specific screening and exclusion criteria deviate from the Sub-Fund's investment strategy. Details of the Benchmark's methodology may be found at jpmorganindices.com.

Allianz Emerging Markets SRI Corporate Bond

Investment Objective

Long term capital growth by investing in corporate Debt Securities of global Emerging Markets in accordance with the Sustainable and Responsible Investment Strategy (SRI Strategy).

Investment Restrictions

- Min. 70% of Sub-Fund assets are invested in Debt Securities in accordance with the investment objective and/or of corporate issuers with a registered office in a country which is a constituent of the J.P. MORGAN ESG Corporate Emerging Market Bond (CEMBI) Broad Diversified
- Max. 30% of Sub-Fund assets may be invested in Debt Securities of global Bonds Markets
- Max. 15% of Sub-Fund assets may be invested in Debt Securities of the PRC Bond Markets
- Sub-Fund assets may be invested in High-Yield Investments Type 2
- Max. 20% non-USD Currency Exposure
- SRI Strategy (including exclusion criteria) applies (Sub-Fund's pre-contractual template describes all relevant information about the strategy's scope, details, and requirements and applied exclusion criteria) and is modified as following:
 - For sovereign issuers an internal scoring model weighting various environmental, social and governance factors is applied for which Freedom House Index is considered as one criterion amongst further criteria. Debt Securities of issuers other than sovereign issuers may not be acquired if the respective issuer's country does not meet the requirements of the aforesaid internal scoring model.
- Min. 90% of Sub-Fund portfolio shall be evaluated by an SRI Rating. Portfolio in this respect does not comprise non-rated derivatives and instruments that are non-rated by nature (e.g., cash and Deposits)
- Min. 20% of Sub-Fund's investment universe is considered to be non-investable (i.e., will be excluded) based on SRI Rating
- Duration: between 1 and 10 years
- Hong Kong Restriction applies
- VAG Investment Restriction applies
- Benchmark: J.P. MORGAN ESG Corporate Emerging Markets Bond (CEMBI) Broad Diversified Total Return. Degree of Freedom: material. Expected Overlap: major
- Benchmark is not completely consistent with the environmental or social characteristics promoted by the Sub-Fund. Both, Sub-Fund and Benchmark use a combination of SRI screening and exclusion of controversial sectors and violations of UN Global Compact. Benchmark's specific screening and exclusion criteria deviate from the Sub-Fund's investment strategy. Details of the Benchmark's methodology may be found at jpmorganindices.com.

Allianz Enhanced Short Term Euro

Investment Objective

Long-term capital growth above the average return of the Euro money markets by investing in global Bond Markets with Euro exposure in accordance with the Sustainable and Responsible Investment Strategy (SRI Strategy). With the objective of achieving additional returns, the Investment Manager may also assume separate risks related to bonds and money market instruments and may engage in foreign currency overlay and thus may also assume separate currency risks, even if the Sub-Fund does not include any assets denominated in these respective currencies.

Investment Restrictions

- Max. 30% of Sub-Fund assets may be invested in Emerging Markets
- Sub-Fund assets may be held in Deposits and may be invested in Debt Securities and/or money market instruments. The residual term of each Debt Security must not exceed 2.5 years
- Max. 65% of Sub-Fund assets may be invested in Debt Securities (excluding money market instruments) with a rating of BBB+ (Standard & Poor's and Fitch) or Baa1 (Moody's) or better
- Sub-Fund assets may not be invested in High-Yield Investments Type 1
- Sub-Fund assets may not be invested in ABS and/or MBS
- Max. 10% non-EUR Currency Exposure
- SRI Strategy (including exclusion criteria) applies. Sub-Fund's pre-contractual template describes all relevant information about the strategy's scope, details, and requirements and applied exclusion criteria.
- Min. 70% of Sub-Fund portfolio shall be evaluated by an SRI Rating. Portfolio in this respect does not comprise non-rated derivatives and instruments that are non-rated by nature (e.g., cash and Deposits)
- Duration: up to 1 year
- VAG Investment Restriction applies
- The Investment Manager focuses on the following types of strategies:
Derivative overlay strategies
Parts of Sub-Funds assets are typically allocated to a derivative overlay strategy which aims to generate additional returns above traditional long only fixed income portfolios. The derivatives overlay strategy consists predominantly of medium to long-term positions in exchange traded liquid interest rate and bond futures and, infrequently, on well risk-controlled positions in currency forwards.
- Benchmark: EURO SHORT-TERM RATE (€STR). Degree of Freedom: significant. Expected Overlap: not applicable

Allianz Euro Bond

Investment Objective

Long-term capital growth above the long-term average return in Euro terms by investing in Debt Securities with Euro exposure of global Bond Markets in accordance with the Sustainable and Responsible Investment Strategy (SRI Strategy).

Investment Restrictions

- Max. 30% of Sub-Fund assets may be invested in Emerging Markets
- Max. 20% of Sub-Fund assets may be invested in High-Yield Investments Type 1
- Max. 20% non-EUR Currency Exposure
- SRI Strategy (including exclusion criteria) applies. Sub-Fund's pre-contractual template describes all relevant information about the strategy's scope, details, and requirements and applied exclusion criteria.
- Min. 90% of Sub-Fund portfolio shall be evaluated by an SRI Rating. Portfolio in this respect does not comprise non-rated derivatives and instruments that are non-rated by nature (e.g., cash and Deposits)
- Duration: between 3 and 9 years
- Benchmark: BLOOMBERG Euro Aggregate Total Return. Degree of Freedom: material. Expected Overlap: major

Allianz Euro Bond Short Term 1-3 Plus

Investment Objective

Long-term capital growth above the medium-term average return in Euro terms by investing in Debt Securities with Euro exposure of global Bonds Markets in accordance with the Sustainable and Responsible Investment Strategy (SRI Strategy).

Investment Restrictions

- Min. 90% of Sub-Fund assets are invested in Debt Securities with Investment Grade rating
- Min. 70% of Sub-Fund assets are invested in Debt Securities of OECD and/or EU member states
- Max. 20% of Sub-Fund assets may be invested in Emerging Markets
- Max. 10% of Sub-Fund assets may be invested in Debt Securities with a rating between BB+ (inclusive) and BB- (inclusive) (Standard & Poor's). If two different ratings exist, the lower rating determines whether a Debt Security is included in the limits set out before; in case of three or more different ratings, the lower of the two best ratings shall be used.
- Max. 10% non-EUR Currency Exposure
- SRI Strategy (including exclusion criteria) applies. Sub-Fund's pre-contractual template describes all relevant information about the strategy's scope, details, and requirements and applied exclusion criteria.
- Min. 90% of Sub-Fund portfolio shall be evaluated by an SRI Rating. Portfolio in this respect does not comprise non-rated derivatives and instruments that are non-rated by nature (e.g., cash and Deposits).

- Duration: between minus 2 and 4 years
- Benchmark: J.P. MORGAN EMU Bond 1-3 Year. Degree of Freedom: material. Expected Overlap: minor

Allianz Euro Credit SRI

Investment Objective

Long-term capital growth by investing in Investment Grade rated Debt Securities of OECD or EU Bond Markets denominated in EUR in accordance with the Sustainable and Responsible Investment Strategy (SRI Strategy).

Investment Restrictions

- Min. 70% of Sub-Fund assets are invested in Debt Securities with Investment Grade
- Min. 70% of Sub-Fund assets are invested in Debt Securities of OECD and/or EU member states
- Max. 30% of Sub-Fund assets may be invested in Debt Securities other than described in the investment objective
- Max. 10% of Sub-Fund assets may be invested in Emerging Markets
- Max. 10% non-EUR Currency Exposure
- Max. 10% of Sub-Fund assets may be invested in Debt Securities with a rating between BB+ (inclusive) and BB- (inclusive) (Standard & Poor's). If two different ratings exist, the lower rating determines whether a Debt Security is included in the limits set out before; in case of three or more different ratings, the lower of the two best ratings shall be used
- Sub-Fund assets may not be invested in Debt Securities issued by companies of the tobacco sector
- SRI Strategy (including exclusion criteria) applies. Sub-Fund's pre-contractual template describes all relevant information about the strategy's scope, details, and requirements and applied exclusion criteria.
- Min. 90% of Sub-Fund portfolio shall be evaluated by an SRI Rating. Portfolio in this respect does not comprise non-rated derivatives and instruments that are non-rated by nature (e.g., cash and Deposits)
- Min. 20% of Sub-Fund's investment universe is considered to be non-investable (i.e., will be excluded) based on SRI Rating
- Duration: between zero and 8 years
- Benchmark: ICE BOFAML Euro Corporate Index (ICE Indices incorporate transaction costs into their calculation). Degree of Freedom: material. Expected Overlap: major

Allianz Euro Government Bond

Investment Objective

Long-term capital growth by investing in government Debt Securities of the Eurozone Bond Markets in accordance with the Sustainable and Responsible Investment Strategy (SRI Strategy).

Investment Restrictions

- Min. 70% of Sub-Fund assets are invested in Debt Securities in accordance with the investment objective
- Max. 10% of Sub-Fund assets may be invested in European Emerging Markets
- Sub-Fund assets may not be invested in preference shares
- Sub-Fund assets may not be invested in High-Yield Investment Type 1
- SRI Strategy (including exclusion criteria) applies. Sub-Fund's pre-contractual template describes all relevant information about the strategy's scope, details, and requirements and applied exclusion criteria.
- Min. 90% of Sub-Fund portfolio shall be evaluated by an SRI Rating. Portfolio in this respect does not comprise non-rated derivatives and instruments that are non-rated by nature (e.g., cash and Deposits)
- Benchmark: IBOXX EUR Sovereigns Eurozone Total Return. Degree of Freedom: material. Expected Overlap: major

Allianz Euro High Yield Bond

Investment Objective

Long-term capital growth by investing in high yield rated Debt Securities denominated in EUR in accordance with the Sustainability Key Performance Indicator Strategy (Relative) ("KPI Strategy (Relative)"). In this context, the aim is to outperform the Sub-Fund's Sustainability KPI compared to Sub-Fund's Benchmark to achieve the investment objective.

Investment Restrictions

- Min. 70% of Sub-Fund assets are invested in High-Yield Investments Type 2
- Max. 15% of Sub-Fund assets may be invested in Emerging Markets
- Max. 10% non-EUR Currency Exposure
- Sub-Fund assets may not be invested in ABS and/or MBS
- KPI Strategy (Relative) (including exclusion criteria) applies. Sub-Fund's pre-contractual template describes all relevant information about the strategy's scope, details, and requirements and applied exclusion criteria.
- Min. 70% of Sub-Fund's portfolio shall be evaluated by the "Weighted Average GHG Intensity (Sales)" (the "Sustainability KPI"). Portfolio in this respect does not comprise derivatives and instruments that are non-evaluated by nature (e.g., cash and Deposits).
- Sub-Fund's investment objective shall be achieved by a minimum outperformance of 20% of Sub-Fund's Sustainability KPI compared to the Weighted Average GHG Intensity (Sales) of Sub-Fund's Benchmark.
- Duration: between 1 and 9 years
- Hong Kong Restriction applies
- Taiwan Restriction applies, except for the respective high-yield limit

- Benchmark: ICE BOFAML Euro High Yield BB-B Constrained (ICE Indices incorporate transaction costs into their calculation). Degree of Freedom: material. Expected Overlap: major

Allianz Euro High Yield Defensive

Investment Objective

Long-term capital growth by investing Debt Securities of European bond markets in accordance with the Sustainability Key Performance Indicator Strategy (Absolute Threshold) ("KPI Strategy (Absolute Threshold)"). In this context, the aim is to target a specific minimum allocation into Sustainable Investments to achieve the investment objective.

Investment Restrictions

- Sub-Fund assets are either invested in Debt Securities in accordance with the investment objective and/or which are or will be constituents of the ICE BOFAML Euro Non-Financial High Yield BB-B but which must not be allocated to the financial sector in accordance with the ICE BOFAML index sector classification methodology (Level 2)
- Min. 70% of Sub-Fund assets are invested in High-Yield Investments Type 2
- Max. 30% of Sub-Fund assets may be invested in Emerging Markets
- The aggregate holdings of Sub-Fund's investments in a single issuer must be smaller than 5 % of Sub-Fund assets. Companies belonging to the same group, as defined in accordance with Directive 83/349/ECC or in accordance with recognized international accounting rules, shall be deemed to be as a single issuer in the aforementioned meaning
- Sub-Fund assets may not be invested in ABS and/or MBS
- Sub-Fund assets may not be invested in UCITS and/or UCI
- Max. 10% non-EUR Currency Exposure
- Sub-Fund assets may be invested in options and/or future-contracts on global equity indices for both, efficient portfolio management and hedging purposes. Sub-Fund assets must not at any time own a synthetic net long position on any equity indices
- KPI Strategy (Absolute Threshold) (including exclusion criteria) applies. Sub-Fund's pre-contractual template describes all relevant information about the strategy's scope, details, and requirements and applied exclusion criteria.
- Duration: between 1 and 9 years
- Hong Kong Restriction applies
- VAG Investment Restriction applies
- Benchmark: ICE BOFAML Euro Non-Financial High Yield BB-B Constrained (ICE Indices incorporate transaction costs into their calculation). Degree of Freedom: material. Expected Overlap: major

Allianz Euro Inflation-linked Bond

Investment Objective

Long term capital growth by investing in Debt Securities of OECD or EU Bond Markets with a focus on inflation-linked bonds in accordance with the Sustainable and Responsible Investment Strategy (SRI Strategy).

Investment Restrictions

- Min. 70% of Sub-Fund assets are invested in Debt Securities of OECD and/or EU bond markets in accordance with the investment objective, thereof min. 51% of Sub-Fund assets are invested in inflation-linked Debt Securities which are denominated in EUR.
- Sub-Fund assets may not be invested in High-Yield Investment Type 1
- Max. 10% of Sub-Fund assets may be invested in ABS and/or MBS with Investment Grade
- Max. 10% of Sub-Fund assets may be invested in Emerging Markets
- Max. 10% non-EUR Currency Exposure
- SRI Strategy (including exclusion criteria) applies. Sub-Fund's pre-contractual template describes all relevant information about the strategy's scope, details, and requirements and applied exclusion criteria.
- Min. 90% of Sub-Fund portfolio shall be evaluated by an SRI Rating. Portfolio in this respect does not comprise non-rated derivatives and instruments that are non-rated by nature (e.g., cash and Deposits)
- Duration: between zero and 20 years
- VAG Investment Restriction applies
- Benchmark: BLOOMBERG Euro Government Inflation-Linked Bond Total Return. Degree of Freedom: material. Expected Overlap: major

Allianz European Bond RC

Investment Objective

Long term capital growth by investing in the European bond markets. The investment policy is geared towards generating appropriate annualised returns above the markets based on European government and corporate bonds while taking into account the opportunities and risks on the European bond markets including derivatives.

Investment Restrictions

- Max. 30% of Sub-Fund assets may be invested in Emerging Markets
- Max. 30% of Sub Fund assets (excluding ABS/MBS) may be invested in High Yield investments Type 2
- Sub Fund assets may be invested in future-contracts and in option-contracts on global equity indices (equity index futures/ equity index options) for both, efficient portfolio management and hedging purposes. Sub-Fund assets must not at any time own a net long position in any equity index futures and/or in any equity index options
- Max. 30% non-EUR Currency Exposure
- Max. 5% of Sub-Fund assets may be invested in the PRC bond markets
- Duration: between minus 2 and 5 year
- VAG Investment Restriction applies
- Benchmark: EURO SHORT-TERM RATE (€STR). Degree of Freedom: significant. Expected Overlap: not applicable

Allianz Flexi Asia Bond

Investment Objective

Long-term capital growth and income by investing in Debt Securities of Asian bond markets denominated in EUR, USD, GBP, JPY, AUD, NZD or any Asian currency in accordance with the Sustainability Key Performance Indicator Strategy (Relative) ("KPI Strategy (Relative)"). In this context, the aim is to outperform the Sub-Fund's Sustainability KPI compared to Sub-Fund's Benchmark to achieve the investment objective.

Investment Restrictions

- Sub-Fund assets may be invested in Emerging Markets
- Max. 60% of Sub-Fund assets may be invested in High-Yield Investments Type 1, however, within this limit max. 10% of Sub-Fund assets may be invested in Debt Securities with a rating of CC (Standard & Poor's) or lower (including defaulted securities)
- Max. 10% of Sub-Fund assets may be invested in the PRC bond markets
- Max 35% may be invested in Debt Securities issued or guaranteed by a single sovereign issuer that is rated below investment grade (i.e., Philippines)
- KPI Strategy (Relative) (including exclusion criteria) applies. Sub-Fund's pre-contractual template describes all relevant information about the strategy's scope, details, and requirements and applied exclusion criteria.
- Min. 80% of Sub-Fund's portfolio shall be evaluated by the "Weighted Average GHG Intensity (Sales)" (the "Sustainability KPI"). Portfolio in this respect does not comprise derivatives and instruments that are non-evaluated by nature (e.g., cash and Deposits).
- Sub-Fund's investment objective shall be achieved by a minimum outperformance of 20% of Sub-Fund's Sustainability KPI compared to the Weighted Average GHG Intensity (Sales) of Sub-Fund's Benchmark.
- Max. 35% RMB Currency Exposure
- Max. 20% non-EUR, non-USD, non-GBP, non-JPY, non-AUD, non-NZD or any non-Asian Currency Exposure
- Duration: between zero and 10 years
- Hong Kong Restriction applies
- Taiwan Restriction applies, except for the respective high-yield limit
- Benchmark: J.P. MORGAN JACI Composite Total Return. Degree of Freedom: material. Expected Overlap: major

Allianz Floating Rate Notes Plus

Investment Objective

Long-term capital growth above the average return of European money markets in Euro terms by investing in global bond markets with a focus on floating-rate notes with Euro exposure in accordance with the Sustainable and Responsible Investment Strategy (SRI Strategy).

Investment Restrictions

- Sub-Fund assets are invested in Debt Securities with Investment Grade rating in accordance with the investment objective
- Min. 70% of Sub-Fund assets are invested in Debt Securities of an OECD and/or EU member state
- Min. 51% of Sub-Fund assets are invested in floating-rate notes and/or Debt Securities with a residual term which must not exceed three months
- Max. 10% of Sub-Fund assets may be invested in Debt Securities with two or more different ratings, one of which at the time of acquisition is a rating of at least BBB- (Standard & Poor's and Fitch) or of at least Baa3 (Moody's) or the equivalent by another Rating Agency or, if unrated, as determined by the Investment Manager to be of comparable quality and the remaining ratings of at least BB- (Standard & Poor's and Fitch) or of at least Ba3 (Moody's) or the equivalent by another Rating Agency or, if unrated, as determined by the Investment Manager to be of comparable quality
- Max. 10% of Sub-Fund assets may be invested in Emerging Markets
- Sub-Fund assets may not be invested in ABS and/or MBS

- Max. 10% non-EUR Currency Exposure
- SRI Strategy (including exclusion criteria) applies. Sub-Fund's pre-contractual template describes all relevant information about the strategy's scope, details, and requirements and applied exclusion criteria.
- Min. 90% of Sub-Fund portfolio shall be evaluated by an SRI Rating. Portfolio in this respect does not comprise non-rated derivatives and instruments that are non-rated by nature (e.g., cash and Deposits).
- Duration: between zero and 18 months
- VAG Investment Restriction applies
- Benchmark: EURO SHORT-TERM RATE (€STR). Degree of Freedom: significant. Expected Overlap: not applicable

Allianz Global Aggregate Bond

Investment Objective

Long-term capital growth by investing in global corporate and government bond markets.

Investment Restrictions

- Sub-Fund assets may be invested in Emerging Markets
- Max. 20% of Sub-Fund assets may be invested in High Yield Investments Type 1
- Max. 30% of Sub-Fund assets may be invested in ABS and/or MBS. The underlying assets of the ABS and/or MBS may include loans, leases or receivables (such as credit card debt and whole business in the case of ABS and commercial and residential mortgages originating from a regulated and authorised financial institution in the case of MBS)
- Max. 20% of Sub-Fund assets may be invested in the PRC bond markets
- Benchmark: BLOOMBERG Global Aggregate Total Return. Degree of Freedom: material. Expected Overlap: major

Allianz Global Credit SRI

Investment Objective

Long-term capital growth by investing in global Bond Markets in accordance with the Sustainable and Responsible Investment Strategy (SRI Strategy).

Investment Restrictions

- Max. 30% of Sub-Fund assets may be invested in Emerging Markets
- Min. 70% of Sub-Fund assets are invested in Debt Securities with Investment Grade
- Max. 30% of Sub-Fund assets may be invested in High Yield Investments Type 1
- Max. 15% of Sub-Fund assets may be invested in the PRC bond markets
- SRI Strategy (including exclusion criteria) applies. Sub-Fund's pre-contractual template describes all relevant information about the strategy's scope, details, and requirements and applied exclusion criteria.
- Min. 70% of Sub-Fund portfolio shall be evaluated by an SRI Rating. Portfolio in this respect does not comprise non-rated derivatives and instruments that are non-rated by nature (e.g., cash and Deposits)
- Hong Kong Restriction applies
- Taiwan Restriction applies
- Benchmark: BLOOMBERG Global Aggregate Credit Total Return. Degree of Freedom: material. Expected Overlap: major

Allianz Global Floating Rate Notes Plus

Investment Objective

The Sub-Fund aims to capture income from a global universe of floating-rate notes. The Sub-Fund seeks potential for long-term capital growth in accordance with the Sustainable and Responsible Investment Strategy (SRI Strategy).

Investment Restrictions

- Min. 51% of Sub-Fund assets are invested in global floating-rate notes in accordance with the investment objective
- Max. 49% of Sub-Fund assets may be invested in Debt Securities other than described in the investment objective
- Max. 30% of Sub-Fund Assets may be invested in High Yield Investments Type I
- Max. 25% of Sub-Fund assets may be invested in ABS and/or MBS. The underlying assets of the ABS and/or MBS may include loans, leases or receivables (such as credit card debt and whole business in the case of ABS and commercial and residential mortgages originating from a regulated and authorised financial institution in the case of MBS).
- Max. 25% of Sub-Fund assets may be invested in Emerging Markets
- SRI Strategy (including exclusion criteria) applies. Sub-Fund's pre-contractual template describes all relevant information about the strategy's scope, details, and requirements and applied exclusion criteria.
- Min. 80% of Sub-Fund portfolio shall be evaluated by an SRI Rating. Portfolio in this respect does not comprise non-rated derivatives and instruments that are non-rated by nature (e.g., cash and Deposits)
- Duration: between 0 and 1.0 years
- Hong Kong Restriction applies
- Benchmark: SECURED OVERNIGHT FINANCING RATE (SOFR). Degree of Freedom: significant. Expected Overlap: not applicable

Allianz Global Government Bond

Investment Objective

Long-term capital growth by investing in global government bond markets.

Investment Restrictions

- Sub-Fund assets may be invested in Emerging Markets
- Max. 20% of Sub-Fund assets may be invested in High Yield Investments Type 1
- Max. 30% of Sub-Fund assets may be invested in ABS and/or MBS. The underlying assets of the ABS and/or MBS may include loans, leases or receivables (such as credit card debt and whole business in the case of ABS and commercial and residential mortgages originating from a regulated and authorised financial institution in the case of MBS).
- Max. 20% of Sub-Fund assets may be invested in the PRC bond markets
- Benchmark: FTSE World Government Bond (WGBl) Total Return. Degree of Freedom: material. Expected Overlap: major

Allianz Global High Yield

Investment Objective

Long-term capital growth by investing in high yield rated Debt Securities of global Bond Markets in accordance with the Sustainability Key Performance Indicator Strategy (Relative) ("KPI Strategy (Relative)"). In this context, the aim is to outperform the Sub-Fund's Sustainability KPI compared to Sub-Fund's Benchmark to achieve the investment objective.

Investment Restrictions

- Sub-Fund assets may be invested in Emerging Markets
- Min. 70% of Sub-Fund assets are invested in High-Yield investments Type 1, however, within this limit Sub-Fund assets may be invested in Debt Securities that are only rated CC (Standard & Poor's) or lower (including max. 10% of defaulted securities)
- Sub-Fund assets may be invested in future-contracts on global equity indices (equity index futures) for both, efficient portfolio management and hedging purposes. Sub-Fund assets must not at any time own a long position in any equity index futures
- Max. 10% non-USD Currency Exposure
- KPI Strategy (Relative) (including exclusion criteria) applies. Sub-Fund's pre-contractual template describes all relevant information about the strategy's scope, details, and requirements and applied exclusion criteria.
- Min. 80% of Sub-Fund's portfolio shall be evaluated by the "Weighted Average GHG Intensity (Sales)" (the "Sustainability KPI"). Portfolio in this respect does not comprise derivatives and instruments that are non-evaluated by nature (e.g., cash and Deposits).
- Sub-Fund's investment objective shall be achieved by a minimum outperformance of 20% of Sub-Fund's Sustainability KPI compared to the Weighted Average GHG Intensity (Sales) of Sub-Fund's Benchmark.
- Hong Kong Restriction applies
- Benchmark: ICE BOFAML Global High Yield Constrained (hedged) (ICE Indices incorporate transaction costs into their calculation). Degree of Freedom: material. Expected Overlap: major

Allianz Global Inflation-Linked Bond

Investment Objective

Long term capital growth by investing in Debt Securities of global Bond Markets with a focus on inflation-linked bonds in accordance with the Sustainable and Responsible Investment Strategy (SRI Strategy).

Investment Restrictions

- Min. 70% of Sub-Fund assets are invested in global Debt Securities, thereof min. 51% of Sub-Fund assets are invested in inflation-linked Debt Securities
- Max. 20% of Sub-Fund assets may be invested in High-Yield Investment Type 2
- Max. 20% of Sub-Fund assets may be invested in Emerging Markets
- Max. 10% of Sub-Fund assets may be invested in ABS and/or MBS with Investment Grade
- SRI Strategy (including exclusion criteria) applies. Sub-Fund's pre-contractual template describes all relevant information about the strategy's scope, details, and requirements and applied exclusion criteria.
- Min. 90% of Sub-Fund portfolio shall be evaluated by an SRI Rating. Portfolio in this respect does not comprise non-rated derivatives and instruments that are non-rated by nature (e.g., cash and Deposits)
- Duration: between zero and 20 years
- VAG Investment Restriction applies
- Benchmark: BLOOMBERG World Government Inflation-Linked Bond Total Return. Degree of Freedom: material. Expected Overlap: major

Allianz Global Multi-Asset Credit

Investment Objective

Long-term returns in excess of SECURED OVERNIGHT FINANCING RATE (SOFR) by investing in global bond markets in accordance with the Sustainable and Responsible Investment Strategy (SRI Strategy).

Investment Restrictions

- Sub-Fund assets may be invested in Emerging Markets
- Min. 70% of Sub-Fund assets are invested in Debt Securities in accordance with the investment objective
- Min. 25% of Sub-Fund assets are invested in Debt Securities with Investment Grade in accordance with the investment objective
- Max. 60% of Sub-Fund assets may be invested in High Yield Investments Type 1, however, within this limit (i) max. 10% of Sub-Fund assets may be invested in Debt Securities with a rating of CCC+ (Standard & Poor's) or lower (including defaulted securities) and (ii) max. 10% of Sub-Fund assets may be invested in unrated Debt Securities with the consequence that a rating is to be determined by the Investment Manager to be of comparable quality. The highest available rating at acquisition day is decisive for the assessment of the possible acquisition of a Debt Security
- Max. 40% of Sub-Fund assets may be invested in ABS and/or MBS. The underlying assets of the ABS and/or MBS may include loans, leases or receivables (such as credit card debt and whole business in the case of ABS and commercial and residential mortgages originating from a regulated and authorised financial institution in the case of MBS).
- Sub-Fund assets may be invested in future-contracts on global equity indices (equity index futures) for both, efficient portfolio management and hedging purposes. Sub-Fund assets must not at any time own a long position in any equity index futures
- Max. 10% non-USD Currency Exposure
- SRI Strategy (including exclusion criteria) applies. Sub-Fund's pre-contractual template describes all relevant information about the strategy's scope, details, and requirements and applied exclusion criteria.
- Min. 70% of Sub-Fund portfolio shall be evaluated by an SRI Rating. Portfolio in this respect does not comprise non-rated derivatives and instruments that are non-rated by nature (e.g., cash and Deposits)
- Hong Kong Restriction applies
- Taiwan Restriction applies, except for the respective high-yield limit
- Benchmark: SECURED OVERNIGHT FINANCING RATE (SOFR). Degree of Freedom: significant. Expected Overlap: not applicable

Allianz Global Multi-Asset Credit SRI

Investment Objective

Long-term returns in excess of SECURED OVERNIGHT FINANCING RATE (SOFR) by investing in global Bond Markets in accordance with the Sustainable and Responsible Investment Strategy (SRI Strategy).

Investment Restrictions

- Sub-Fund assets may be invested in Emerging Markets
- Min. 70% of Sub-Fund assets are invested in Debt Securities in accordance with the investment objective
- Min. 25% of Sub-Fund assets are invested in Debt Securities with Investment Grade in accordance with the investment objective
- Max. 60% of Sub-Fund assets may be invested in High Yield Investments Type 1, however, within this limit (i) max. 10% of Sub-Fund assets may be invested in Debt Securities with a rating of CCC+ (Standard & Poor's) or lower (including defaulted securities) and (ii) max. 10% of Sub-Fund assets may be invested in unrated Debt Securities with the consequence that a rating is to be determined by the Investment Manager to be of comparable quality.
- Max. 40% of Sub-Fund assets may be invested in ABS and/or MBS.
- Sub-Fund assets may be invested in future-contracts on global equity indices (equity index futures) for both, efficient portfolio management and hedging purposes. Sub-Fund assets must not at any time own a net long position in any equity index futures
- Max. 10% non-USD Currency Exposure
- SRI Strategy (including exclusion criteria) applies. Sub-Fund's pre-contractual template describes all relevant information about the strategy's scope, details, and requirements and applied exclusion criteria.
- Min. 70% of Sub-Fund portfolio shall be evaluated by an SRI Rating. Portfolio in this respect does not comprise non-rated derivatives and instruments that are non-rated by nature (e.g., cash and Deposits)
- Hong Kong Restriction applies
- Benchmark: SECURED OVERNIGHT FINANCING RATE (SOFR). Degree of Freedom: significant. Expected Overlap: not applicable

Allianz Global Opportunistic Bond

Investment Objective

Long-term capital growth and income by investing in global bond markets. As part of the investment process, the Investment Manager applies an opportunistic approach, which provides in particular that a spectrum of macro and credit opportunities are accessed.

Investment Restrictions

- Max. 30% of Sub-Fund assets may be invested in High-Yield Investments Type 1
- Max. 30% of Sub-Fund assets may be invested in Emerging Markets
- Max. 20% of Sub-Fund assets may be invested in the PRC bond markets
- Sub-Fund assets may be invested in options and/or future-contracts on global equity indices for both, efficient portfolio management and hedging purposes. Sub-Fund assets must not at any time own a synthetic net long position on any equity indices
- Duration: between 0 and 9 years
- Hong Kong Restriction applies
- Taiwan Restriction applies
- Benchmark: SECURED OVERNIGHT FINANCING RATE (SOFR). Degree of Freedom: significant. Expected Overlap: not applicable

Allianz Green Bond

Investment Objective

Long-term capital growth by investing in Investment Grade rated Green Bonds of the global Bond Markets denominated in currencies of OECD countries in accordance with the Green Bond Strategy.

Investment Restrictions

- Max. 30% of Sub-Fund assets may be invested in Emerging Markets
- Min. 85% of Sub-Fund assets are invested in Green Bonds
- Min. 80% of Sub-Fund assets are invested in Debt Securities with Investment Grade
- Max. 25% of Sub-Fund assets may be held in Deposits and/or invested in Money Market Instruments and/or (up to 10% of Sub-Fund assets) in money market funds on a temporary basis for liquidity management
- Max. 10% of Sub-Fund assets may be invested in ABS and/or MBS with Investment Grade
- Max. 10% of Sub-Fund assets may be invested in High-Yield Investments Type 2
- Max. 10% non-EUR Currency Exposure
- Green Bond Strategy (including exclusion criteria) applies. Sub-Fund's pre-contractual template describes all relevant information about the strategy's scope, details, and requirements and applied exclusion criteria.
- Duration: between zero and 13 years
- Hong Kong Restriction applies
- Taiwan Restriction applies
- Benchmark: ICE BOFAML Green Bond (hedged into EUR) (ICE Indices incorporate transaction costs into their calculation). Degree of Freedom: material. Expected Overlap: major
- Benchmark is not completely aligned with the Sub-Fund's Sustainable Investment objective. Both, Sub-Fund and Benchmark use a combination of SRI screening and exclusion of controversial sectors and violations of UN Global Compact. Benchmark's specific screening and exclusion criteria deviate from the Sub-Fund's investment strategy. Details of the Benchmark's methodology may be found at www.theice.com.

Allianz Green Transition Bond

Investment Objective

Long-term capital growth by investing in Debt Securities of the Global Bond Markets with a focus on issuers (companies, sovereign and quasi-sovereign issuers) providing positive contribution to sustainable and environmental-friendly solutions and transition into a low-carbon economy in accordance with the Green Transition Strategy.

Investment Restrictions

- Min. 80% of Sub-Fund assets are invested in Debt Securities in accordance with the Green Transition Strategy. Sub-Fund's pre-contractual template describes all relevant information about the strategy's scope, details, and requirements and applied exclusion criteria.
- Max. 15% of Sub-Fund assets may be invested in the PRC bond markets
- Max. 40% of Sub-Fund assets may be invested in Emerging Markets or in countries which are constituents of the J.P. MORGAN ESG Emerging Market Bond (EMBI) Global Diversified
- Max. 30% of Sub-Fund assets may be invested in High-Yield Investments Type 1
- Duration: between zero and 10 years
- Benchmark: 1/3 BLOOMBERG MSCI Global Green Bond Total Return (hedged into USD) + 1/3 BLOOMBERG MSCI Global Corporate Sustainability Total Return (hedged into USD) + 1/3 J.P. MORGAN ESG Emerging Market Bond (EMBI) Global Diversified. Degree of Freedom: material. Expected Overlap: minor

- Benchmark is not completely consistent with the environmental or social characteristics promoted by the Sub-Fund. Both, Sub-Fund and Benchmark use a combination of SRI screening and exclusion of controversial sectors and violations of UN Global Compact. Benchmark's specific screening and exclusion criteria deviate from the Sub-Fund's investment strategy. Details of the Benchmark's methodology may be found at www.msci.com, www.bloomberg.com and jpmorganindices.com.

Allianz HKD Income

Investment Objective

Long-term income by investing in Debt Securities denominated in Hong Kong Dollar.

Investment Restrictions

- Min. 70% of Sub-Fund assets are denominated in Hong Kong Dollar
- Max. 30% of Sub-Fund assets may be invested in High-Yield Investments Type 2
- Max. 30% of Sub-Fund assets may be invested in Emerging Markets
- Max. 30% of Sub-Fund assets may be denominated in RMB and/or other currencies
- Sub-Fund assets may not be invested in ABS and/or MBS
- Duration: below 10 years
- Hong Kong Restriction applies
- Benchmark: none

Allianz Renminbi Fixed Income

Investment Objective

Long-term capital growth by investing in bond markets of the PRC, denominated in CNY.

Investment Restrictions

- Sub-Fund assets may be invested in Emerging Markets
- Sub-Fund assets are invested in Debt Securities, Money Market Instruments and/or may be held in Deposits
- Min. 70% of Sub-Fund assets are invested in accordance with the investment objective
- Max. 100% of Sub-Fund assets may be invested in the PRC bond markets, including so called urban investment bonds
- Max. 69% of Sub-Fund assets may be invested via FII Program
- Max. 30% of Sub-Fund assets may be invested in High-Yield Investments Type 1
- Duration: below 10 years
- Hong Kong Restriction applies
- Benchmark: J.P. MORGAN Government Bond - Emerging Markets (GBI-EM) Broad China 1-10 Year Total Return. Degree of Freedom: significant. Expected Overlap: minor

Allianz SDG Euro Credit

Investment Objective

Long term capital growth by investing in Debt Securities with Investment Grade denominated in Euro of Eurozone or OECD Bond in accordance with the SDG Aligned Strategy Type A with a focus on companies with an engagement in one or more United Nations' SDGs and/ or on securities supporting climate-related or social projects, and hence create positive outcomes for environment and society.

Investment Restrictions

- Min. 85% of Sub-Fund assets are invested in Bonds issued by companies with an engagement in one or more SDGs and/or issued by companies supporting climate-related or social projects and/or in Green Bonds, Social Bonds, Sustainable Bonds and Sustainability-Linked bonds. Companies in the aforesaid meaning are companies which offer products and/or services across the themes of affordable healthcare, education, energy transition, food security, financial inclusion, water, and waste management as targeted by the SDGs No. 1 to No. 17.
- SDG-Aligned Strategy Type A (including exclusion criteria) applies. Sub-Fund's pre-contractual template describes all relevant information about the strategy's scope, details, and requirements and applied exclusion criteria.
- Min. 70% of Sub-Fund assets are invested in Debt Securities with Investment Grade rating
- Min. 70% of Sub-Fund assets are invested in Debt Securities of OECD and/or EU Member States
- Max. 10% of Sub-Fund assets may be invested in convertible debt securities and/or in contingent convertible bonds
- Max. 10% Sub-Fund assets may be invested in Emerging Markets
- Max. 10% of Sub-Fund assets may be invested in Debt Securities that at the time of acquisition are not rated by a rating agency
- Max. 10% of Sub-Fund assets (excluding ABS/MBS) may be invested in High Yield Investments Type 2
- Max. 10% non-EUR Currency Exposure
- Duration: between 1 and 8 years
- Taiwan Restriction applies
- VAG Investment Restriction applies
- Benchmark: BLOOMBERG Euro Aggregate Corporate Total Return. Degree of Freedom: material. Expected Overlap: major

Allianz Selective Global High Income

Investment Objective

Long-term capital growth and income by investing in global bond markets. The Sub-Fund tries to offer close to high yield returns with an expected volatility between investment grade and high yield in accordance with the Sustainability Key Performance Indicator Strategy (Relative) ("KPI Strategy (Relative)"). In this context, the aim is to outperform the Sub-Fund's Sustainability KPI compared to Sub-Fund's Benchmark to achieve the investment objective.

Investment Restrictions

- Sub-Fund assets may be invested in Emerging Markets
- Min. 70% of Sub-Fund assets are invested in Debt Securities with a rating of BB- (Standard & Poor's) or higher
- Max. 30% of Sub-Fund assets may be invested in Debt Securities with a rating of B+ or lower (Standard & Poor's), however, Debt Securities with a rating of CCC+ (Standard & Poor's) or lower (including defaulted securities) may not be acquired. The highest available rating at acquisition day is decisive for the assessment of the possible acquisition of a Debt Security
- KPI Strategy (Relative) (including exclusion criteria) applies. Sub-Fund's pre-contractual template describes all relevant information about the strategy's scope, details, and requirements and applied exclusion criteria.
- Min. 90% of Sub-Fund's portfolio shall be evaluated by the "Weighted Average GHG Intensity (Sales)" (the "Sustainability KPI"). Portfolio in this respect does not comprise derivatives and instruments that are non-evaluated by nature (e.g., cash and deposits).
- Sub-Fund's investment objective shall be achieved by a minimum outperformance of 30% of Sub-Fund's Sustainability KPI compared to the Weighted Average GHG Intensity (Sales) of Sub-Fund's Benchmark.
- Min. 20% of Sub-Fund's investment universe is considered to be non-investable (i.e., will be excluded) based on the highest GHG Intensity
- The Sub-Fund's Weighted Average GHG Intensity (Sales) outperforms the Sub-Fund's Benchmark Weighted Average GHG Intensity (Sales) excluding the 20% highest GHG Intensity issuers
- Sub-Fund assets may be invested in future-contracts on global equity indices (equity index futures) for both, efficient portfolio management and hedging purposes. Sub-Fund assets must not at any time own a long position in any equity index futures
- Max. 10% non-USD Currency Exposure
- Hong Kong Restriction applies
- VAG Investment Restriction applies
- Benchmark: ICE BOFAML BB-B Global High Yield Index (hedged) (ICE Indices incorporate transaction costs into their calculation). Degree of Freedom: material. Expected Overlap: major

Allianz SGD Income

Investment Objective

Long-term capital growth and income in SGD terms by investing in Debt Securities of global bond markets.

Investment Restrictions

- Sub-Fund assets may be invested in Emerging Markets
- Max. 40% of Sub-Fund assets may be invested in High-Yield Investment Type 1
- Max. 40% of Sub-Fund assets may be invested in the PRC bond markets
- Duration: between 0 and 10 years
- Max. 30% non-SGD Currency Exposure
- Hong Kong Restriction applies
- Benchmark: none

Allianz Short Duration Global Bond SRI

Investment Objective

Long-term growth by investing in global Bond Markets in accordance with the Sustainable and Responsible Investment Strategy (SRI Strategy).

Investment Restrictions

- Sub-Fund assets are invested in Debt Securities with Investment Grade
- Max. 20% of Sub-Fund assets may be invested in Emerging Markets
- Max. 10% of Sub-Fund assets may be invested in ABS and/or MBS with Investment Grade
- SRI Strategy (including exclusion criteria) applies. Sub-Fund's pre-contractual template describes all relevant information about the strategy's scope, details, and requirements and applied exclusion criteria.
- Min. 90% of Sub-Fund portfolio shall be evaluated by an SRI Rating. Portfolio in this respect does not comprise non-rated derivatives and instruments that are non-rated by nature (e.g., cash and Deposits)
- Duration: between zero and 3 years
- Benchmark: FTSE 3-Month Treasury Bill Total Return. Degree of Freedom: significant. Expected Overlap: minor

Allianz Treasury Short Term Plus Euro

Investment Objective

Long-term capital growth above the average-term return in Euro (EUR) terms by investing in Debt Securities with Euro Exposure of Eurozone Bond Markets in accordance with the Sustainable and Responsible Investment Strategy (SRI Strategy).

Investment Restrictions

- Min. 51% of Sub-Fund assets are invested in Debt Securities of the Eurozone bond markets
- Min. 51% of Sub-Fund assets are denominated in EUR
- Max. 49% of Sub-Fund assets may be invested in Debt Securities other than described in the investment objective
- Max. 10% of Sub-Fund assets (excluding ABS/MBS) may be invested in High-Yield Investments Type 2
- Max. 10% of Sub-Fund assets may be invested in ABS/MBS with Investment Grade
- Max. 10% Non-EUR Currency Exposure
- SRI Strategy (including exclusion criteria) applies. Sub-Fund's pre-contractual template describes all relevant information about the strategy's scope, details, and requirements and applied exclusion criteria.
- Min. 70% of Sub-Fund portfolio shall be evaluated by an SRI Rating. Portfolio in this respect does not comprise non-rated derivatives and instruments that are non-rated by nature (e.g., cash and Deposits)
- Duration: up to 1 year
- VAG Investment Restriction applies
- Benchmark: EURIBOR 3-Month. Degree of Freedom: significant. Expected Overlap: not applicable

Allianz UK Government Bond

Investment Objective

Long term capital growth by investing in UK government Bond Markets. The investment policy is geared towards generating appropriate annualised returns above the markets based on UK government bonds by taking into account the opportunities and risks of a strategy in long and short positions in the global government bond markets.

Investment Restrictions

- Max. 20% of Sub-Fund assets may be invested in Debt Securities (either denominated in Sterling or hedged back to Sterling) other than described in the investment objective with a credit rating similar or better than that of the United Kingdom government
- Sub-Fund assets may not be invested in High-Yield bonds
- Sub-Fund assets may not be invested in preference shares
- VAG Investment Restriction applies
- Benchmark: FTSE Actuaries UK Conventional Gilts All Stocks Index Midday Total Return GBP. Degree of Freedom: material. Expected Overlap: major

Allianz US High Yield

Investment Objective

Long-term capital growth and income by investing in high yield rated corporate bonds of US bond markets.

Investment Restrictions

- Min. 70% of Sub-Fund assets are invested in corporate bonds from the US
- Min. 70% of Sub-Fund assets are invested in High-Yield Investments Type 1, however, within this limit Sub-Fund assets may be invested in Debt Securities that are only rated CC (Standard & Poor's) or lower (including max. 10% of defaulted securities)
- Max. 30% of Sub-Fund assets may be invested in Emerging Markets
- Max. 20% non-USD Currency Exposure
- Duration: between zero and 9 years
- Hong Kong Restriction applies
- Taiwan Restriction applies, except for the respective high-yield limit
- Benchmark: none

Allianz US Investment Grade Credit

Investment Objective

Long-term capital growth and income by investing in investment grade rated corporate Debt Securities of US Bond Markets denominated in USD.

Investment Restrictions

- Min. 80% of Sub-Fund assets are invested in Debt Securities with Investment Grade
- Max. 10% of Sub-Fund assets may be invested in High-Yield Investments Type 2
- Max. 10% of Sub-Fund assets may be invested in Emerging Markets
- Max. 10% of the Sub-Fund assets may be invested in the PRC Bond Market
- Max. 20% of Sub-Fund assets may be invested in US government Debt Securities (US treasury securities)
- Duration: between minus 2 and 2 years from the duration of the benchmark
- Hong Kong Restriction applies
- Taiwan Restriction applies
- VAG Investment Restriction applies
- Benchmark: Bloomberg US Corporate Total Return. Degree of Freedom: material. Expected Overlap: major

Allianz US Short Duration High Income Bond

Investment Objective

Long-term income and lower volatility by investing in short duration high yield rated corporate Debt Securities of US Bond Markets in accordance with the Sustainability Key Performance Indicator Strategy (Absolute) ("KPI Strategy (Absolute)"). In this context, the aim is, at least, a year-on-year improvement pathway on the Sub-Fund's Sustainability KPI to achieve the investment objective.

Investment Restrictions

- Min. 70% of Sub-Fund assets are invested in corporate bonds from the US
- Min. 70% of Sub-Fund assets are invested in High-Yield Investments Type 1
- Max. 20% of Sub-Fund assets may be invested in Emerging Markets
- Max. 20% non-USD Currency Exposure
- KPI Strategy (Absolute) (including exclusion criteria) applies. Sub-Fund's pre-contractual template describes all relevant information about the strategy's scope, details, and requirements and applied exclusion criteria.
- Min. 70% of Sub-Fund's portfolio shall be evaluated by the "Weighted Average GHG Intensity (Sales)" (the "Sustainability KPI"). Portfolio in this respect does not comprise derivatives and instruments that are non-evaluated by nature (e.g., cash and Deposits).
- Sub-Fund's investment objective shall be achieved by at least a 5% year-on-year improvement pathway at the fiscal year end of the Sub-Fund's Weighted Average GHG Intensity (Sales) starting at the reference date: 30 May 2023. For the period between reference date and the first fiscal year end a pro rata temporis rate of the annual rate will be applied.
- Duration: between zero and 3 years
- Hong Kong Restriction applies
- Taiwan Restriction applies, except for the respective high-yield limit
- Benchmark: none

3. Multi Asset Funds

The principles set out in the “General Part” are supplemented by the following principles and limits which exclusively apply to all Multi Asset Sub-Funds unless otherwise stated in a Multi Asset Sub-Fund’s individual Investment Restrictions:

- A Sub-Fund’s Investment Manager follows, unless otherwise stated in a Sub-Fund’s investment objective (or in the investment restriction), always an active management approach (as mentioned in Appendix 1, Part A, No. 19).
- Min. 70% of Sub-Fund assets are invested in Equities and/or Debt Securities and/or other asset classes in accordance with the investment objective.
- Less than 30% of Sub-Fund assets may be invested in Equities and/or Debt Securities and/or other asset classes other than described in the investment objective.
- Max. 20% of Sub-Fund assets may be invested in ABS and/or MBS.
- Max. 10% of Sub-Fund assets may be invested in contingent convertible bonds.
- Max. 10% of Sub-Fund assets may be invested in UCITS and/or UCI.
- Max. 100% Sub-Fund assets may be held in time deposits and/or (up to 20% of Sub-Fund assets) in deposits at sight and/or invested directly in Money Market Instruments and/or (up to 10% of Sub-Fund assets) in money market funds on a temporary basis for liquidity management and/or defensive purpose and/or any other exceptional circumstances, and if the investment manager considers it in the best interest of the Sub-Fund.
- Where a country, region and/or market is referred to in the investment objective (or in the investment restriction), a Sub-Fund will (or will not) make investments which have exposure or connection to such country, region and/or markets. Such investments include Debt Securities that are issued or guaranteed by governments, municipalities, agencies, supra-nationals, central, regional or local authority and companies of (including those that generate a predominant share of their sales or their profits in) such country, region and/or market as well as companies that are under common management or control of or have substantial direct or indirect participation in the foregoing companies.
- Where a country, region and/or market is referred to in the investment objective (or in the investment restriction), a Sub-Fund will (or will not) make investments which have exposure or connection to such country, region and/or markets. Such investments include Equities of companies listed on a Regulated Market or incorporated, with a registered office or principal place of business, or that generate a predominant share of sales or profits in such country, region, or market, as well as companies under common management or control of, or have substantial direct or indirect participation in, the foregoing companies.
- The allocation of the Sub-Fund’s investments across asset classes may vary substantially from time to time. The Sub-Fund’s investments in each asset class are based upon the Investment Managers’ assessment of economic conditions and market factors, including equity price levels, interest rate levels and their anticipated direction.
- A Benchmark is always used for a Sub-Fund’s Performance Measures if not otherwise referred to in the Sub-Fund’s individual investment restrictions. A Benchmark may be used also for a Sub-Fund’s Portfolio Composition, where such case is explicitly referred to in the Sub-Fund’s individual investment restrictions. In both cases the Investment Manager’s aim is to outperform the Benchmark. A Sub-Fund’s Benchmark (and in the case that such Benchmark is explicitly used for a Sub-Fund’s Portfolio Composition), and the Investment Manager’s Degree of Freedom to deviate from the Benchmark and the expected overlap between the Sub-Fund’s invested securities and the constituents of its Benchmark are referred to, unless not applicable, in a Sub-Fund’s individual Investment Restrictions. (Please refer to Appendix 1, Part A, No. 19)

Allianz Asian Multi Income Plus

Investment Objective

Long-term capital growth and income by investing in Asia Pacific equity and bond markets.

Investment Restrictions

- Sub-Fund assets may be invested in Emerging Markets
- Min. 70% of Sub-Fund assets are invested directly in accordance with the investment objective
- Max. 85% of Sub-Fund assets may be invested in Equities and Equities which are business trusts according to “Business Trusts Act 2004” of the Republic of Singapore in accordance with the investment objective
- Max. 85% of Sub-Fund assets may be invested in Debt Securities in accordance with the investment objective
- Max. 85% Sub-Fund assets may be held in Deposits and/or invested directly in Money Market Instruments and/or (up to 10% of Sub-Fund assets) in money market funds on a temporary basis for liquidity management and/or defensive purpose and/or any other exceptional circumstances, and if the investment manager considers it in the best interest of the Sub-Fund
- Max. 60% of Sub-Fund assets may be invested in High Yield Investments Type 1
- Max. 30% of Sub-Fund assets may be invested into the China A-Shares market
- Max. 10% of Sub-Fund assets may be invested into the China B-Shares market
- Max. 30% of Sub-Fund assets may be held in Deposits and be invested in Money Market Instruments and (up to 10% of Sub-Fund assets) in money market funds
- Duration: below 10 years
- Hong Kong Restriction applies
- Taiwan Restriction applies, except for the respective high-yield limit
- GITA Restriction (Alternative 1) applies
- Benchmark: none

Allianz Best Ideas 2025

Investment Objective

Long-term capital growth by investing in a broad range of global asset classes. The investment decisions are based on a fundamental management approach. The portfolio will consist of two components – the core portfolio and the opportunistic portfolio. Via the core portfolio it is intended to generate stable returns over the market cycle. The opportunistic portfolio is designed to capture shorter term investment opportunities and will be more actively managed than the core portfolio. The turnover will be higher than in the core portfolio allocation of capital between the two components of the portfolios depending on market circumstances and consequently will fluctuate over time. With the objective of achieving additional returns, the Investment Manager may also assume separate foreign currency risks, even if the Sub-Fund does not include any assets denominated in these respective currencies.

Liquidation date: Planned for seven years from Sub-Fund's launch date

Distribution date: Starting on the next Dealing Date following the Maturity Date

Investment Restrictions

- Sub-Fund assets may be invested in Emerging Markets
- Sub-Fund assets may be invested in High-Yield Investments Type 2
- Sub-Fund assets may be invested in UCITS and/or UCI on an unlimited basis
- Sub-Fund assets may be invested in securities referring to
 1. Equities
 2. Debt Securities
 3. UCITS and/or UCI
 4. Indices (including bond, equity (including assets of companies operating in the private equity sector), hedge funds indices and indices on commodity futures, precious metal or commodities as well as indices that refer to companies active in the area of private equity); securities referring to indices other than financial indices are only to be acquired if they are geared towards a 1:1 replication of the underlying index/indices
 5. Commodities
 6. Commodity forward and/or future contracts
 7. Currencies
 8. Currency forward and/or future contracts
 9. Real estate property funds and/or
 10. Baskets of the aforementioned underlying assets.
- Securities referring to an underlying asset as defined in No. 5 to 8 may only be acquired if they are geared towards a 1:1 replication of the respective underlying asset. This applies accordingly to securities as defined in No. 10, insofar as they have underlying assets as defined in in No. 5 to 8. Securities with an underlying asset as defined in No. 5 to 9 may not provide for any mandatory physical delivery or grant the issuer the right to make physical delivery of the relevant underlying asset. This applies accordingly to securities as defined in No. 10, insofar as they have underlying assets as defined in No. 5 to 9.
- Max. 10% of Sub-Fund assets may be invested into China A-Shares market
- Max. 10% of Sub-Fund assets may be invested in the PRC bond markets
- Duration: not restricted
- Max. 100% Sub-Fund assets may be held in Deposits and be invested in in money market instruments and (up to 100% of Sub-Fund assets) may be invested in Money Market Funds on a temporary basis for liquidity management and/or defensive purpose and/or any other exceptional circumstances, and if the investment manager considers it in the best interest of the Sub-Fund.
- Benchmark: EURO SHORT-TERM RATE (€STR). Degree of Freedom: significant. Expected Overlap: not applicable

Allianz Better World Defensive

Investment Objective

Long-term capital growth by investing in global Equity and Bond Markets in accordance with the SDG Aligned Strategy Type A with a focus on companies with an engagement in one or more United Nations' SDGs and/ or on companies supporting climate-related or social projects, and hence create positive outcomes for environment and society.

Investment Restrictions

- Min. 90% of Sub-Fund assets are invested in Equities and/or in Bonds issued by companies with an engagement in one or more SDGs and/or issued by companies supporting climate-related or social projects and/or in Green Bonds, Social Bonds, Sustainable Bonds and Sustainability-Linked bonds. Companies in the aforesaid meaning are companies which offer products and/or services across the themes of affordable healthcare, education, energy transition, food security, financial inclusion, water, and waste management as targeted by the SDGs No. 1 to No. 17.
- Max. 60% of Sub-Fund assets may be invested in Equities
- Max. 50% of Sub-Fund assets may be invested in Emerging Markets
- Max. 10% of Sub-Fund assets may be invested in convertible debt securities and/or in contingent convertible bonds
- Max. 10% of Sub-Fund assets may be invested in High-Yield Investments Type 2
- Max. 10% of Sub-Fund assets may be invested into the China A-Shares market
- SDG-Aligned Strategy Type A (including exclusion criteria) applies. Sub-Fund's pre-contractual template describes all relevant information about the strategy's scope, details, and requirements and applied exclusion criteria.
- Hong Kong Restriction applies
- Taiwan Restriction applies

- Duration on NAV level: between minus 2 and 10 years
- VAG Investment Restriction applies
- A Sub-Fund's Investment Manager uses total return swaps to generate positive or negative exposure to the respective asset classes (further information are disclosed in Appendix 7)
- Benchmark: none; No reference benchmark has been designated for the purpose of attaining the sustainable investment objective of the Sub-Fund

Allianz Better World Dynamic

Investment Objective

Long-term capital growth by investing in global Equity and Bond Markets in accordance with the SDG Aligned Strategy Type A with a focus on companies with an engagement in one or more United Nations' SDGs and/ or on companies supporting climate-related or social projects, and hence create positive outcomes for environment and society.

Investment Restrictions

- Min. 90% of Sub-Fund assets are invested in Equities and/or in Bonds issued by companies with an engagement in one or more SDGs and/or issued by companies supporting climate-related or social projects and/or in Green Bonds, Social Bonds, Sustainable Bonds and Sustainability-Linked bonds. Companies in the aforesaid meaning are companies which offer products and/or services across the themes of affordable healthcare, education, energy transition, food security, financial inclusion, water, and waste management as targeted by the SDGs No. 1 to No. 17.
- Min. 40% of Sub-Fund assets are and max. 100% of Sub-Fund assets may be invested in Equities
- Max. 50% of Sub-Fund assets may be invested in Emerging Markets
- Max. 10% of Sub-Fund assets may be invested in convertible debt securities and/or in contingent convertible bonds
- Max. 10% of Sub-Fund assets may be invested in High-Yield Investments Type 2
- Max. 10% of Sub-Fund assets may be invested into the China A-Shares market
- SDG-Aligned Strategy Type A (including exclusion criteria) applies. Sub-Fund's pre-contractual template describes all relevant information about the strategy's scope, details, and requirements and applied exclusion criteria.
- Hong Kong Restriction applies
- Taiwan Restriction applies
- Duration on NAV level: between minus 2 and 10 years
- VAG Investment Restriction applies
- GITA Restriction (Alternative 1) applies
- A Sub-Fund's Investment Manager uses total return swaps to generate positive or negative exposure to the respective asset classes (further information are disclosed in Appendix 7)
- Benchmark: none; No reference benchmark has been designated for the purpose of attaining the sustainable investment objective of the Sub-Fund

Allianz Better World Moderate

Investment Objective

Long-term capital growth by investing in global Equity and Bond Markets in accordance with the SDG Aligned Strategy Type A with a focus on companies with an engagement in one or more United Nations' SDGs and/ or on companies supporting climate-related or social projects, and hence create positive outcomes for environment and society.

Investment Restrictions

- Min. 90% of Sub-Fund assets are invested in Equities and/or in Bonds issued by companies with an engagement in one or more SDGs and/or issued by companies supporting climate-related or social projects and/or in Green Bonds, Social Bonds, Sustainable Bonds and Sustainability-Linked bonds. Companies in the aforesaid meaning are companies which offer products and/or services across the themes of affordable healthcare, education, energy transition, food security, financial inclusion, water, and waste management as targeted by the SDGs No. 1 to No. 17.
- Min. 20% of Sub-Fund assets are and max. 80% of Sub-Fund assets may be invested in Equities
- Max. 50% of Sub-Fund assets may be invested in Emerging Markets
- Max. 10% of Sub-Fund assets may be invested in convertible debt securities and/or in contingent convertible bonds
- Max. 10% of Sub-Fund assets may be invested in High-Yield Investments Type 2
- Max. 10% of Sub-Fund assets may be invested into the China A-Shares market
- SDG-Aligned Strategy Type A (including exclusion criteria) applies. Sub-Fund's pre-contractual template describes all relevant information about the strategy's scope, details, and requirements and applied exclusion criteria.
- Hong Kong Restriction applies
- Taiwan Restriction applies
- Duration on NAV level: between minus 2 and 10 years
- VAG Investment Restriction applies
- GITA Restriction (Alternative 2) applies
- A Sub-Fund's Investment Manager uses total return swaps to generate positive or negative exposure to the respective asset classes (further information are disclosed in Appendix 7)
- Benchmark: none; No reference benchmark has been designated for the purpose of attaining the sustainable investment objective of the Sub-Fund

Allianz Capital Plus

Investment Objective

Long-term capital growth by investing in European equity and bond markets in accordance with the Multi Asset Sustainability Strategy.

Investment Restrictions

- Min. 90% of Sub-Fund assets are invested in Equities and/or Debt Securities in accordance with the Multi Asset Sustainability Strategy and/or in internal SFDR Target Funds. Sub-Fund's pre-contractual template describes all relevant information about the strategy's scope, details, and requirements and applied exclusion criteria.
- Min. 20% of Sub-Fund assets are and max. 40% of Sub-Fund assets may be invested in Equities in accordance with the investment objective
- Max. 80% of Sub-Fund assets may be invested in Debt Securities in accordance with the investment objective
- Max. 80% Sub-Fund assets may be held in Deposits or invested in Money Market Instruments and (up to 10% of Sub-Fund assets) in money market funds on a temporary basis for liquidity management and/or defensive purpose and/or any other exceptional circumstances, and if the investment manager considers it in the best interest of the Sub-Fund.
- Max. 30% of Sub-Fund assets may be invested in Debt Securities issued by corporates
- Max. 5% of Sub-Fund assets may be invested in Equities other than described in the investment objective
- Max. 10% of Sub-Fund assets may be invested in High-Yield Investments Type 2
- Max. 10% of Sub-Fund assets may be invested in Emerging Markets
- Max. 10% non-EUR Currency Exposure in Debt Securities
- Taiwan Restriction applies
- GITA Restriction (Alternative 2) applies
- Benchmark: 70% BLOOMBERG Euro Aggregate 1-10 Year Total Return + 30% MSCI Europe Total Return Net. Degree of Freedom: material. Expected Overlap: major

Allianz Capital Plus Global

Investment Objective

Long-term capital growth by investing in Global Equity and Bond Markets in accordance with the Multi Asset Sustainability Strategy.

Investment Restrictions

- Min. 90% of Sub-Fund assets are invested in Equities and/or Debt Securities in accordance with the Multi Asset Sustainability Strategy and/or in internal SFDR Target Funds. Sub-Fund's pre-contractual template describes all relevant information about the strategy's scope, details, and requirements and applied exclusion criteria.
- Sub-Fund assets may be invested in Emerging Markets
- Min. 25% of Sub-Fund assets are and max. 40% of Sub-Fund assets may be invested in Equities in accordance with the investment objective
- Max. 75% of Sub-Fund assets may be invested in Debt Securities in accordance with the investment objective
- Max. 75% of Sub-Fund assets may be held in Deposits or invested in Money Market Instruments and (up to 10% of Sub-Fund assets) in money market funds on a temporary basis for liquidity management and/or defensive purpose and/or any other exceptional circumstances, and if the investment manager considers it in the best interest of the Sub-Fund
- Max. 20% of Sub-Fund assets may be invested in High-Yield Investments Type 2
- Max. 20% of Sub-Fund assets may be invested in ABS and/or MBS with Investment Grade
- Max. 15% of Sub-Fund assets may be invested in the PRC bond markets
- Max. 10% of Sub-Fund assets may be invested in the China A-Shares market
- Hong Kong Restriction applies
- Taiwan Restriction applies
- VAG Investment Restriction applies
- GITA Restriction (Alternative 2) applies
- Benchmark: 70% BLOOMBERG Global Aggregate 500 Excl. CNY Total Return + 30% MSCI AC World (ACWI) Total Return Net. Degree of Freedom: material. Expected Overlap: major

Allianz China Multi Income Plus

Investment Objective

Long-term capital growth and income by investing in equity and bond markets of the PRC, Hong Kong and Macau.

Investment Restrictions

- Sub-Fund assets may be invested in Emerging Markets
- Min. 70% of Sub-Fund assets are invested directly in accordance with the investment objective
- Max. 80% of Sub-Fund assets may be invested in Equities
- Max. 80% of Sub-Fund assets may be invested in Debt Securities
- Max. 80% Sub-Fund assets may be held in Deposits and/or invested directly in Money Market Instruments and/or (up to 10% of Sub-Fund assets) in money market funds on a temporary basis for liquidity management and/or defensive purpose and/or any other exceptional circumstances, and if the investment manager considers it in the best interest of the Sub-Fund
- Max. 80% of Sub-Fund assets may be invested in High-Yield Investments Type 1, however, within this limit Sub-Fund assets may be invested in Debt Securities that are only rated CC (Standard & Poor`s) or lower (including max. 10% of defaulted securities)
- Max. 50% of Sub-Fund assets may be invested into the China A-Shares market, China B-Shares market and/or in Debt Securities of the PRC bond markets
- Duration: between and zero and 10 years
- Hong Kong Restriction applies
- GITA Restriction (Alternative 2) applies
- Benchmark: none

Allianz Coupon Select Plus V

Investment Objective

Long-term capital growth and income by investing in a broad range of asset classes, in particular in the global bond-, equity-, alternative- and money markets. The Sub-Fund may also achieve its investment objective by investing in internal investment funds with different regional focuses from a global investment universe.

Investment Restrictions

- Max. 60% of Sub-Fund assets may be invested in Emerging Markets. Included in this limit are target fund investments if the respective acquired target funds are deemed to be "Emerging Market Funds" according to the Morningstar classification
- Max. 60% of Sub-Fund assets may be invested in High-Yield Investments Type 1. Included in this limit are target fund investments if the respective acquired target funds are deemed to be "High Yield Funds" according to the Morningstar classification
- Sub-Fund assets may be invested in UCITS and/or UCI on an unlimited basis
- Max. 30% of Sub-Fund assets may be invested in Equities
- Max. 100% Sub-Fund assets may be held in Deposits and be invested in in money market instruments and (up to 100% of Sub-Fund assets) may be invested in Money Market Funds on a temporary basis for liquidity management and/or defensive purpose and/or any other exceptional circumstances, and if the investment manager considers it in the best interest of the Sub-Fund.
- Duration: between minus 2 and 10 years
- Benchmark: none

Allianz Dynamic Multi Asset Strategy SRI 15

Investment Objective

Long term capital growth by investing in a broad range of asset classes, with a focus on global Equity, Bond and Money Markets in order to achieve over the medium-term a performance comparable to a balanced portfolio within a volatility range of 3% to 7% in accordance with the Sustainable and Responsible Investment Strategy (SRI Strategy).

The assessment of the volatility of the capital markets by the Investment Manager is an important factor in this process, with the aim of typically not falling below or exceeding a volatility of the Share price within a range of 3% to 7% on a medium to long-term average, similar to a portfolio consisting of 15% global equity markets and 85% Euro-denominated bonds of the Global bond markets.

Investment Restrictions

- Max. 35% of Sub-Fund assets may be invested in Equities. However, max. 50% of Sub-Fund assets may be invested directly / physically in Equities and comparable securities (e.g., equity certificates, equity funds).
- Max. 25% of Sub-Fund assets may be invested in Emerging Markets
- Max. 15% of Sub-Fund assets may be invested in High-Yield Investments which carry a rating between BB+ and CCC- (Standard & Pools). If two different ratings exist, the lower rating determines whether a Debt Security is included in the limits set out before; in case of three or more different ratings, the lower of the two best ratings shall be used.
- Max. 30% of Sub-Fund assets may be invested in UCITS and/or UCI
- Max. 10% of Sub-Fund assets may be invested in ABS and/or MBS

- SRI Strategy (including exclusion criteria) applies. Sub-Fund's pre-contractual template describes all relevant information about the strategy's scope, details, and requirements and applied exclusion criteria.
- Min. 70% of Sub-Fund portfolio shall be evaluated by an SRI Rating. Portfolio in this respect does not comprise non-rated derivatives and instruments that are non-rated by nature (e.g., cash and Deposits)
- Derivatives on both, SRI indices or non-SRI indices, which are used for hedging purposes are not included in the calculation to determine accordance with the SRI strategy.
- Duration on NAV level: between minus 2 and 10 years
- Switzerland Restriction applies
- VAG Investment Restriction applies
- A Sub-Fund's Investment Manager uses total return swaps to generate positive or negative exposure to the respective asset classes (further information are disclosed in Appendix 7)
- Benchmark: none

Allianz Dynamic Multi Asset Strategy SRI 50

Investment Objective

Long term capital growth by investing in a broad range of asset classes, with a focus on global Equity, Bond and Money Markets in order to achieve over the medium-term a performance comparable to a balanced portfolio within a volatility range of 6% to 12% in accordance with the Sustainable and Responsible Investment Strategy (SRI Strategy).

The assessment of the volatility of the capital markets by the Investment Manager is an important factor in this process, with the aim of typically not falling below or exceeding a volatility of the Share price within a range of 6% to 12% on a medium to long-term average, similar to a portfolio consisting of 50% global equity markets and 50% Euro-denominated bonds of the Global bond markets.

Investment Restrictions

- Max. 30% of Sub-Fund assets may be invested in Emerging Markets
- Max. 20% of Sub-Fund assets may be invested in High-Yield Investments Type 1
- Max. 30% of Sub-Fund assets may be invested in UCITS and/or UCI
- SRI Strategy (including exclusion criteria) applies. Sub-Fund's pre-contractual template describes all relevant information about the strategy's scope, details, and requirements and applied exclusion criteria.
- Min. 70% of Sub-Fund portfolio shall be evaluated by an SRI Rating. Portfolio in this respect does not comprise non-rated derivatives and instruments that are non-rated by nature (e.g., cash and Deposits)
- Derivatives on both, SRI indices or non-SRI indices, which are used for hedging purposes are not included in the calculation to determine accordance with the SRI strategy
- Duration NAV level: between minus 2 and 10 years
- GITA Restriction (Alternative 2) applies
- VAG Investment Restriction applies
- A Sub-Fund's Investment Manager uses total return swaps to generate positive or negative exposure to the respective asset classes (further information are disclosed in Appendix 7)
- Benchmark: none

Allianz Dynamic Multi Asset Strategy SRI 75

Investment Objective

Long term capital growth by investing in a broad range of asset classes, with a focus on global Equity, Bond and Money Markets in order to achieve over the medium-term a performance comparable to a balanced portfolio within a volatility range of 10% to 16% in accordance with the Sustainable and Responsible Investment Strategy (SRI Strategy).

The assessment of the volatility of the capital markets by the Investment Manager is an important factor in this process, with the aim of typically not falling below or exceeding a volatility of the Share price within a range of 10% to 16% on a medium to long-term average, similar to a portfolio consisting of 75% global equity markets and 25% Euro-denominated bonds of the Global bond markets.

Investment Restrictions

- Max. 30% of Sub-Fund assets may be invested in Emerging Markets
- Max. 20% of Sub-Fund assets may be invested in High-Yield Investments Type 1
- Max. 30% of Sub-Fund assets may be invested in UCITS and/or UCI
- SRI Strategy (including exclusion criteria) applies. Sub-Fund's pre-contractual template describes all relevant information about the strategy's scope, details, and requirements and applied exclusion criteria.
- Min. 70% of Sub-Fund portfolio shall be evaluated by an SRI Rating. Portfolio in this respect does not comprise non-rated derivatives and instruments that are non-rated by nature (e.g., cash and Deposits)
- Derivatives on both, SRI indices or non-SRI indices, which are used for hedging purposes are not included in the calculation to determine accordance with the SRI strategy
- Duration on NAV level: between minus 2 and 10 years
- GITA Restriction (Alternative 1) applies
- VAG Investment Restriction applies
- A Sub-Fund's Investment Manager uses total return swaps to generate positive or negative exposure to the respective asset classes (further information are disclosed in Appendix 7)
- Benchmark: none

Allianz Emerging Markets Multi Asset Income

Investment Objective

Long term capital growth and income by investing in Equities and/or Debt Securities of global Emerging Markets and/or Money Market Instruments of global (emerging and/or developed) markets.

Investment Restrictions

- Min. 70% of Sub-Fund assets are invested in Emerging Markets Countries and/or in South Korea, Taiwan, Poland, Hungary, Greece, Croatia, Qatar, Saudi Arabia, Kuwait, United Arab Emirates, Chile, Panama, and Uruguay
- Max. 40% of Sub-Fund assets may be invested in High-Yield Investments Type 1
- Max. 10% of Sub-Fund assets may be invested in UCITS and/or UCI, thereof max. 10% of Sub-Fund assets may be invested in UCITS and/or UCI which are ETFs and max. 5% of Sub-Fund asset may be invested in UCITS and/or UCI which are not ETFs
- Duration: between minus 2 and 10 years
- Hong Kong Restriction applies
- Benchmark: none

Allianz Euro Balanced

Investment Objective

Long-term capital growth by investing in Eurozone Equity Markets and Eurozone Government Bond Markets in accordance with the Sustainable and Responsible Investment Strategy (SRI Strategy).

Investment Restrictions

- Min. 30% of Sub-Fund assets are invested in Debt Securities in accordance with the investment objective
- Min. 30% of Sub-Fund assets are invested in Equities in accordance with the investment objective
- Max. 30% of Sub-Fund assets may be invested in REITs
- Sub-Fund assets may not be invested in High-Yield Investments Type 1
- Max. 10% of Sub-Fund assets may be invested in Emerging Markets
- Max. 70% Sub-Fund assets may be held in Deposits and/or invested directly in Money Market Instruments and/or (up to 10% of Sub-Fund assets) in money market funds on a temporary basis for liquidity management and/or defensive purpose and/or any other exceptional circumstances, and if the investment manager considers it in the best interest of the Sub-Fund.
- SRI Strategy (including exclusion criteria) applies. Sub-Fund's pre-contractual template describes all relevant information about the strategy's scope, details, and requirements and applied exclusion criteria.
- Min. 90% of Sub-Fund portfolio shall be evaluated by an SRI Rating. Portfolio in this respect does not comprise non-rated derivatives and instruments that are non-rated by nature (e.g., cash and Deposits)
- GITA Restriction (Alternative 2) applies
- Benchmark: 50% IBOXX EUR Sovereigns Eurozone Total Return + 50% MSCI EMU Total Return Net. Degree of Freedom: material. Expected Overlap: major

Allianz Europe Income and Growth

Investment Objective

Long term capital growth and income by investing in European corporate Debt Securities and Equities.

Investment Restrictions

- Sub-Fund assets may be invested in Emerging Markets
- Min. 70% of Sub-Fund assets are invested directly in accordance with the investment objective
- Max. 80% of Sub-Fund assets may be invested in Debt Securities in accordance with the investment objective
- Max. 80% of Sub-Fund assets may be invested in Equities in accordance with the investment objective
- Max. 70% of Sub-Fund assets may be invested in convertible debt securities in accordance with the investment objective
- Max. 70% of Sub-Fund assets may be invested in High-Yield Investments Type 1 in accordance with the investment objective
- Max. 25% of Sub-Fund assets may be held in Deposits and/or may be invested in Money-Market Instruments and/or (up to 10% of Sub-Fund assets) in money market funds
- Hong Kong Restriction applies
- GITA Restriction (Alternative 2) applies
- Benchmark: none

Allianz Global Capital Plus

Investment Objective

Long-term capital growth by investing in Global Equity and Bond Markets in accordance with the Multi Asset Sustainability Strategy.

Investment Restrictions

- Min. 90% of Sub-Fund assets are invested in Equities and/or Debt Securities in accordance with the Multi Asset Sustainability Strategy and/or in internal SFDR Target Funds. Sub-Fund's pre-contractual template describes all relevant information about the strategy's scope, details, and requirements and applied exclusion criteria.
- Sub-Fund assets may be invested in Emerging Markets
- Min. 25% of Sub-Fund assets are and max. 40% of Sub-Fund assets may be invested in Equities in accordance with the investment objective
- Max. 75% of Sub-Fund assets may be invested in Debt Securities in accordance with the investment objective
- Max. 75% of Sub-Fund assets may be held in Deposits or invested in Money Market Instruments and (up to 10% of Sub-Fund assets) in money market funds on a temporary basis for liquidity management and/or defensive purpose and/or any other exceptional circumstances, and if the investment manager considers it in the best interest of the Sub-Fund
- Max. 20% of Sub-Fund assets may be invested in High-Yield Investments Type 2
- Max. 20% of Sub-Fund assets may be invested in ABS and/or MBS with Investment Grade
- Max. 15% of Sub-Fund assets may be invested in the PRC bond markets
- Max. 10% of Sub-Fund assets may be invested in the China A-Shares market
- Max. 10% of non-EUR Currency Exposure as far as Debt Securities are concerned
- Benchmark: 70% BLOOMBERG Global Aggregate 500 Excl. CNY Total Return + 30% MSCI AC World (ACWI) Total Return Net. Degree of Freedom: material. Expected Overlap: major

Allianz Global Dynamic Multi Asset Income

Investment Objective

Long term capital growth and income by investing in a broad range of asset classes, with a focus on global equity, bond and money markets which offer attractive yields and/or sustainable dividend payments.

Investment Restrictions

- Min. 70% of Sub-Fund assets are invested in Equities and/or in Debt Securities and/or in UCITS/UCI in accordance with the investment objective
- Sub-Fund assets may be completely invested in UCITS/UCI
- Max. 40% of Sub-Fund assets may be invested in Emerging Markets. Included in this limit are target fund investments if the respective acquired target funds are deemed to be "Emerging Market Funds" according to the Morningstar classification
- Max. 40% of Sub-Fund assets may be invested in High-Yield Investments Type 2
- Max. 100% Sub-Fund assets may be held in Deposits and/or invested directly in Money Market Instruments and/or in money market funds on a temporary basis for liquidity management and/or defensive purpose and/or any other exceptional circumstances, and if the investment manager considers it in the best interest of the Sub-Fund
- Duration: between minus 5 and 15 years
- Hong Kong Restriction applies
- Benchmark: none

Allianz Global Income

Investment Objective

Long term income and capital growth by investing in a broad range of asset classes, in particular in global Equity and global Bond Markets.

Investment Restrictions

- Max. 70% of Sub-Fund assets may be invested in Equities
- Max. 30% of Sub-Fund assets may be invested in High-Yield investments Type 1 (Debt Securities which qualify as convertible debt securities will not be accounted to this 30%-limit irrespective of their rating), however Sub-Fund assets may be invested in Debt Securities that are only rated CC (Standard & Poor's) or lower (including max. 10% of defaulted securities)
- Max. 20% of Sub-Fund assets may be invested in Debt Securities which qualify as convertible debt securities irrespective of their rating
- Sub-Fund assets may be invested in Emerging Markets
- Max. 25% of Sub-Fund assets may be held in Deposits and/ or may be invested directly in Money-Market instruments and/or (up to 10% of Sub-Fund assets) in money market funds
- Max. 20% of Sub-Fund assets may be invested into the China A-Shares market and/or into the China B-Shares market and/or PRC bond markets
- Max. 20% non-USD Currency Exposure
- Hong Kong Restrictions applies
- Taiwan Restriction applies
- GITA Restriction (Alternative 2) applies
- Benchmark: none

Allianz Global Intelligent Cities Income

Investment Objective

Long-term income and capital growth by investing in global Equity and Bond Markets with a focus on companies whose business will benefit from or is currently related to evolution of intelligent cities and connected communities in accordance with the Sustainability Key Performance Indicator Strategy (Relative) ("KPI Strategy (Relative)"). In this context, the aim is to outperform the Sub-Fund's Sustainability KPI compared to Sub-Fund's Benchmark to achieve the investment objective.

Investment Restrictions

- Max. 20% of Sub-Fund assets may be invested in High-Yield Investments Type 1 (Debt Securities which qualify as convertible debt securities will not be accounted to this 20%-limit irrespective of their rating), however Sub-Fund assets may be invested in Debt Securities that are only rated CC (Standard & Poor's) or lower (including max. 10% of defaulted securities)
- Max. 35% of Sub-Fund assets may be invested in Debt Securities which qualify as convertible debt securities
- Sub-Fund assets may be invested in Emerging Markets
- Max. 20% of Sub-Fund assets may be invested into the China A-Shares market
- KPI Strategy (Relative) (including exclusion criteria) applies. Sub-Fund's pre-contractual template describes all relevant information about the strategy's scope, details, and requirements and applied exclusion criteria.
- Min. 80% of Sub-Fund's portfolio shall be evaluated by the "Weighted Average GHG Intensity (Sales)" (the "Sustainability KPI"). Portfolio in this respect does not comprise derivatives and instruments that are non-evaluated by nature (e.g., cash and Deposits).
- Sub-Fund's investment objective shall be achieved by a minimum outperformance of 20% of Sub-Fund's Sustainability KPI compared to the Weighted Average GHG Intensity (Sales) of Sub-Fund's Benchmark.
- Hong Kong Restriction applies
- Malaysian Investment Restriction applies
- Taiwan Restriction applies, however the investment in High Yield Investments Type 1 shall not exceed 20% of Sub-Fund assets
- GITA Restriction (Alternative 2) applies
- Benchmark: 70% MSCI AC World (ACWI) Total Return Net + 30% ICE BOFAML US Corporate & High Yield Index (ICE Indices incorporate transaction costs into their calculation). Degree of Freedom: significant. Expected Overlap: major

Allianz Global Multi Asset Sustainability Balanced

Investment Objective

Long term capital growth by investing in a broad range of asset classes, with a focus on global equity, bond and money markets in order to achieve over the medium-term a performance comparable to a balanced portfolio consisting of 50% global equity markets and 50% global bond markets in accordance with the Multi Asset Sustainability Strategy.

Investment Restrictions

- Min. 70% of Sub-Fund assets are invested in Equities and/or Debt Securities in accordance with the Multi Asset Sustainability Strategy (excluding "Climate Engagement Strategy") and/or in internal SFDR Target Funds (excluding Climate Engagement with Outcome Strategy). Sub-Fund's pre-contractual template describes all relevant information about the strategy's scope, details, and requirements and applied exclusion criteria.
- Max. 30% of Sub-Fund assets may be invested in Emerging Markets. Included in this limit are target fund investments if the respective acquired target funds are deemed to be "Emerging Market Funds" according to the Morningstar classification
- Max. 20% of Sub-Fund assets may be invested in High-Yield Investments Type 1
- Max. 10% of Sub-Fund assets may be invested into China A-Shares market
- Max. 10% of Sub-Fund assets may be invested in the PRC bond markets
- Max. 10% of Sub-Fund assets may be invested in UCITS and/or UCI, thereof max. 10% of Sub-Fund assets may be invested in UCITS and/or UCI which are ETFs and max. 5% of Sub-Fund asset may be invested in UCITS and/or UCI which are not ETFs
- Duration: between minus 2 and 10 years
- Hong Kong Restriction applies
- GITA Restriction (Alternative 2) applies
- A Sub-Fund's Investment Manager uses total return swaps to generate positive or negative exposure to the respective asset classes (further information are disclosed in Appendix 7)
- Benchmark: none

Allianz Global Multi Asset Sustainability Conservative

Investment Objective

Long term capital growth by investing in a broad range of asset classes, with a focus on global equity, bond and money markets in order to achieve over the medium-term a performance comparable to a balanced portfolio consisting of 25% global equity markets and 75% global bond markets in accordance with the Multi Asset Sustainability Strategy.

Investment Restrictions

- Min. 70% of Sub-Fund assets are invested in Equities and/or Debt Securities in accordance with the Multi Asset Sustainability Strategy (excluding "Climate Engagement Strategy") and/or in internal SFDR Target Funds. Sub-Fund's pre-contractual template describes all relevant information about the strategy's scope, details, and requirements and applied exclusion criteria.
- Max. 50% of Sub-Funds assets may be invested in Equities according to the investment objective
- Max. 30% of Sub-Fund assets may be invested in Emerging Markets. Included in this limit are target fund investments if the respective acquired target funds are deemed to be "Emerging Market Funds" according to the Morningstar classification
- Max. 20% of Sub-Fund assets may be invested in High-Yield Investments Type 1
- Max. 20% of Sub-Fund assets may be invested in the PRC bond markets
- Max. 10% of Sub-Fund assets may be invested into China A-Shares market
- Max. 10% of Sub-Fund assets may be invested in UCITS and/or UCI, thereof max. 10% of Sub-Fund assets may be invested in UCITS and/or UCI which are ETFs and max. 5% of Sub-Fund asset may be invested in UCITS and/or UCI which are not ETFs
- Duration: between minus 2 and 10 years
- Hong Kong Restriction applies
- A Sub-Fund's Investment Manager uses total return swaps to generate positive or negative exposure to the respective asset classes (further information are disclosed in Appendix 7)
- Benchmark: none

Allianz Global Multi Asset Sustainability Growth

Investment Objective

Long term capital growth by investing in a broad range of asset classes, with a focus on global equity, bond and money markets in order to achieve over the medium-term a performance comparable to a balanced portfolio consisting of 75% global equity markets and 25% global bond markets in accordance with the Multi Asset Sustainability Strategy.

Investment Restrictions

- Min. 70% of Sub-Fund assets are invested in Equities and/or Debt Securities in accordance with the Multi Asset Sustainability Strategy (excluding "Climate Engagement Strategy") and/or in internal SFDR Target Funds. Sub-Fund's pre-contractual template describes all relevant information about the strategy's scope, details, and requirements and applied exclusion criteria.
- Max. 30% of Sub-Fund assets may be invested in Emerging Markets. Included in this limit are target fund investments if the respective acquired target funds are deemed to be "Emerging Market Funds" according to the Morningstar classification
- Max. 20% of Sub-Fund assets may be invested in High-Yield Investments Type 1
- Max. 10% of Sub-Fund assets may be invested into China A-Shares market
- Max. 10% of Sub-Fund assets may be invested in the PRC bond markets
- Max. 10% of Sub-Fund assets may be invested in UCITS and/or UCI, thereof max. 10% of Sub-Fund assets may be invested in UCITS and/or UCI which are ETFs and max. 5% of Sub-Fund asset may be invested in UCITS and/or UCI which are not ETFs
- Duration: between minus 2 and 10 years
- Hong Kong Restriction applies
- A Sub-Fund's Investment Manager uses total return swaps to generate positive or negative exposure to the respective asset classes (further information are disclosed in Appendix 7)
- Benchmark: none

Allianz Income and Growth

Investment Objective

Long term capital growth and income by investing in corporate Debt Securities and Equities of US and/or Canadian equity and bond markets.

Investment Restrictions

- Max. 70% of Sub-Fund assets may be invested in Equities in accordance with the investment objective
- Max. 70% of Sub-Fund assets may be invested in convertible debt securities in accordance with the investment objective
- Max. 70% of Sub-Fund assets may be invested in High-Yield Investments Type 1, however Sub-Fund assets may be invested in Debt Securities that are only rated CC (Standard & Poor's) or lower (including max. 10% of defaulted securities)
- Max. 30% of Sub-Fund assets may be invested in Emerging Markets
- Max. 25% of Sub-Fund assets may be held in Deposits and/or may be invested directly in Money-Market Instruments and/or (up to 10% of Sub-Fund assets) in money market funds
- Max. 20% non-USD Currency Exposure
- Hong Kong Restriction applies
- Taiwan Restriction applies, except for the respective high-yield limit

- GITA Restriction (Alternative 2) applies
- Benchmark: none

Allianz Oriental Income

Investment Objective

Long-term capital growth by investing in Asia-Pacific Equity and Bond Markets.

Investment Restrictions

- Sub-Fund assets may be invested in Emerging Markets
- Min. 40% of Sub-Fund assets are invested in Equities in accordance with the investment objective
- Min. 50% of Sub-Fund assets are invested in Equities
- Max. 50% of Sub-Fund assets may be invested in Debt Securities
- Max. 50% Sub-Fund assets may be held in Deposits and/or invested directly in Money Market Instruments and/or (up to 10% of Sub-Fund assets) in money market funds on a temporary basis for liquidity management and/or defensive purpose and/or any other exceptional circumstances, and if the investment manager considers it in the best interest of the Sub-Fund
- Max. 30% of Sub-Fund assets may be invested into the China A-Shares market
- Sub-Fund assets may not be invested in High-Yield Investments Type 1
- Hong Kong Restriction applies
- Malaysian Investment Restriction applies
- Taiwan Restriction applies, except for the respective equity limit
- VAG Investment Restriction applies
- GITA Restriction (Alternative 1) applies
- Benchmark: MSCI AC Asia Pacific Total Return Net. Degree of Freedom: significant. Expected Overlap: minor

Allianz Select Income and Growth

Investment Objective

Long term capital growth and income by investing in corporate Debt Securities and Equities of US and/or Canadian Equity and Bond markets.

Investment Restrictions

- Sub-Fund assets may be invested in Debt Securities, however max. 70% of Sub-Fund assets may be invested in convertible debt securities
- Max. 70% of Sub-Fund assets may be invested in Equities in accordance with the investment objective
- Max. 30% of Sub-Fund assets may be invested in High-Yield Investments Type 1, however Sub-Fund assets may be invested in Debt Securities that are only rated CC (Standard & Poor's) or lower (including max. 10% of defaulted securities)
- Max. 30% of Sub-Fund assets may be invested in Emerging Markets
- GITA Restriction (Alternative 2) applies
- Hong Kong Restriction applies
- Malaysian Investment Restriction applies
- Benchmark: none

Allianz Strategy Select 30

Investment Objective

Long term capital growth by investing in global Equity, European Bond and Money Markets in order to achieve over the medium-term a performance comparable to a balanced portfolio within a volatility range of 2% - 8%. The assessment of the volatility of the capital markets by the Investment Manager is an important factor in this process, with the aim of typically not falling below or exceeding a volatility of the Share price within a range of 2% - 8% on a medium to long-term average, similar to a portfolio consisting of 30% global Equity Markets and 70% medium-term Euro Bond Markets. In times of high volatility / low volatility the equity market-oriented portion will be reduced / will be increased.

Investment Restrictions

- Sub-Fund assets may not be invested in High Yield Investments Type 1
- Max. 4% of Sub-Fund assets may be invested in Emerging Markets
- Max. 5% non-Euro Currency Exposure for non-equity Sub-Fund assets
- Duration: between zero and 9 years
- The Investment Manager focuses on the following derivative strategy:
The Investment Manager gains exposure to the global Equity Markets and the European Bond Markets by investing in Futures-Contracts.
- Benchmark: none

Allianz Strategy Select 50

Investment Objective

Long term capital growth by investing in global Equity, European Bond and Money Markets in order to achieve over the medium-term a performance comparable to a balanced portfolio within a volatility range of 5% - 11%. The assessment of the volatility of the capital markets by the Investment Manager is an important factor in this process, with the aim of typically not falling below or exceeding a volatility of the Share price within a range of 5% - 11% on a medium to long-term average, similar to a portfolio consisting of 50% global Equity Markets and 50% medium-term Euro Bond Markets. In times of high volatility / low volatility the equity market-oriented portion will be reduced / will be increased.

Investment Restrictions

- Sub-Fund assets may not be invested in High Yield Investments Type 1
- Max. 4% of Sub-Fund assets may be invested in Emerging Markets
- Max. 5% non-Euro Currency Exposure for non-equity Sub-Fund assets
- Duration: between zero and 9 years
- The Investment Manager focuses on the following derivative strategy:
The Investment Manager gains exposure to the global Equity Markets and the European Bond Markets by investing in Futures-Contracts.
- Benchmark: none

Allianz Strategy Select 75

Investment Objective

Long term capital growth by investing in global Equity, European Bond and Money Markets in order to achieve over the medium-term a performance comparable to a balanced portfolio within a volatility range of 8% - 16%. The assessment of the volatility of the capital markets by the Investment Manager is an important factor in this process, with the aim of typically not falling below or exceeding a volatility of the Share price within a range of 8% - 16% on a medium to long-term average, similar to a portfolio consisting of 75% global Equity Markets and 25% medium-term Euro Bond Markets. In times of high volatility / low volatility the equity market-oriented portion will be reduced / will be increased.

Investment Restrictions

- Sub-Fund assets may not be invested in High Yield Investments Type 1
- Max. 4% of Sub-Fund assets may be invested in Emerging Markets
- Max. 5% non-Euro Currency Exposure for non-equity Sub-Fund assets
- Duration: between zero and 9 years
- The Investment Manager focuses on the following derivative strategy:
The Investment Manager gains exposure to the global Equity Markets and the European Bond Markets by investing in Futures-Contracts.
- Benchmark: none

Allianz Strategy4Life 30

Investment Objective

Long term capital growth by investing in global Equity, European Bond and Money Markets in order to achieve over the medium-term a performance comparable to a balanced portfolio within a volatility range of 2% - 8%. The assessment of the volatility of the capital markets by the Investment Manager is an important factor in this process, with the aim of typically not falling below or exceeding a volatility of the Share price within a range of 2% - 8% on a medium to long-term average, similar to a portfolio consisting of 30% global Equity Markets and 70% medium-term Euro Bond Markets in accordance with the Sustainable and Responsible Investment Strategy (SRI Strategy). In times of high volatility/ low volatility the equity market-oriented portion will be reduced/ will be increased.

Investment Restrictions

- Sub-Fund assets may not be invested in High Yield Investments Type 1
- Max. 4% of Sub-Fund assets may be invested in Emerging Markets
- Max. 5% non-Euro Currency Exposure for non-equity Sub-Fund assets
- SRI Strategy (including exclusion criteria) applies. Sub-Fund's pre-contractual template describes all relevant information about the strategy's scope, details, and requirements and applied exclusion criteria.
- Min. 90% of Sub-Fund portfolio shall be evaluated by a SRI Rating. Portfolio in this respect does not comprise non-rated derivatives and instruments that are non-rated by nature (e.g., cash and Deposits)
- Duration: between zero and 9 years
- The Investment Manager focuses on the following derivative strategy:
The Investment Manager gains exposure to the global Equity Markets and the European Bond Markets by investing in Futures-Contracts.
- Benchmark: none

Allianz Strategy4Life 50

Investment Objective

Long term capital growth by investing in global Equity, European Bond and Money Markets in order to achieve over the medium-term a performance comparable to a balanced portfolio within a volatility range of 5% - 11%. The assessment of the volatility of the capital markets by the Investment Manager is an important factor in this process, with the aim of typically not falling below or exceeding a volatility of the Share price within a range of 5% - 11% on a medium to long-term average, similar to a portfolio consisting of 50% global Equity Markets and 50% medium-term Euro Bond Markets in accordance with the Sustainable and Responsible Investment Strategy (SRI Strategy). In times of high volatility/ low volatility the equity market-oriented portion will be reduced/ will be increased.

Investment Restrictions

- Sub-Fund assets may not be invested in High Yield Investments Type 1
- Max. 4% of Sub-Fund assets may be invested in Emerging Markets
- Max. 5% non-Euro Currency Exposure for non-equity Sub-Fund assets
- SRI Strategy (including exclusion criteria) applies. Sub-Fund's pre-contractual template describes all relevant information about the strategy's scope, details, and requirements and applied exclusion criteria.
- Min. 90% of Sub-Fund portfolio shall be evaluated by a SRI Rating. Portfolio in this respect does not comprise non-rated derivatives and instruments that are non-rated by nature (e.g., cash and Deposits)
- Duration: between zero and 9 years
- The Investment Manager focuses on the following derivative strategy:
The Investment Manager gains exposure to the global Equity Markets and the European Bond Markets by investing in Futures-Contracts.
- Benchmark: none

Allianz Strategy4Life 75

Investment Objective

Long term capital growth by investing in global Equity, European Bond and Money Markets in order to achieve over the medium-term a performance comparable to a balanced portfolio within a volatility range of 8% - 16%. The assessment of the volatility of the capital markets by the Investment Manager is an important factor in this process, with the aim of typically not falling below or exceeding a volatility of the Share price within a range of 8% - 16% on a medium to long-term average, similar to a portfolio consisting of 75% global Equity Markets and 25% medium-term Euro Bond Markets in accordance with the Sustainable and Responsible Investment Strategy (SRI Strategy). In times of high volatility/ low volatility the equity market-oriented portion will be reduced/ will be increased.

Investment Restrictions

- Sub-Fund assets may not be invested in High Yield Investments Type 1
- Max. 4% of Sub-Fund assets may be invested in Emerging Markets
- Max. 5% non-Euro Currency Exposure for non-equity Sub-Fund assets
- SRI Strategy (including exclusion criteria) applies. Sub-Fund's pre-contractual template describes all relevant information about the strategy's scope, details, and requirements and applied exclusion criteria.
- Min. 90% of Sub-Fund portfolio shall be evaluated by a SRI Rating. Portfolio in this respect does not comprise non-rated derivatives and instruments that are non-rated by nature (e.g., cash and Deposits)
- Duration: between zero and 9 years
- The Investment Manager focuses on the following derivative strategy:
The Investment Manager gains exposure to the global Equity Markets and the European Bond Markets by investing in Futures-Contracts.
- Benchmark: none

Allianz Strategy4Life Europe 40

Investment Objective

Long term capital growth by investing in European Equity, European Bond and Money Markets in order to achieve over the medium-term a performance comparable to a balanced portfolio within a volatility range of 3% - 9%. The assessment of the volatility of the capital markets by the Investment Manager is an important factor in this process, with the aim of typically not falling below or exceeding a volatility of the Share price within a range of 3% - 9% on a medium to long-term average, similar to a portfolio consisting of 40% European Equity Markets and 60% medium-term Euro Bond Markets in accordance with the Sustainable and Responsible Investment Strategy (SRI Strategy). In times of high volatility / low volatility the equity market-oriented portion will be reduced / will be increased.

Investment Restrictions

- Sub-Fund assets may not be invested in High Yield Investments Type 1
- Max. 4% of Sub-Fund assets may be invested in Emerging Markets
- Max. 5% non-Euro Currency Exposure for non-equity Sub-Fund assets
- SRI Strategy (including exclusion criteria) applies. Sub-Fund's pre-contractual template describes all relevant information about the strategy's scope, details, and requirements and applied exclusion criteria.

- Min. 90% of Sub-Fund portfolio shall be evaluated by a SRI Rating. Portfolio in this respect does not comprise non-rated derivatives and instruments that are non-rated by nature (e.g., cash and Deposits)
- Duration: between zero and 9 years
- The Investment Manager focuses on the following derivative strategy:
The Investment Manager gains exposure to the European Equity Markets and the European Bond Markets by investing in Futures-Contracts.
- Benchmark: none

Allianz Sustainable Multi Asset 75

Investment Objective

Long term capital growth by investing in a broad range of asset classes, with a focus on global Equity, Bond, and Money Markets in order to achieve over the medium-term a performance comparable to a balanced portfolio within a volatility range of 10% to 16% in accordance with the Multi Asset Sustainability Investment Strategy. The assessment of the volatility of the capital markets by the Investment Manager is an important factor in this process, with the aim of typically not falling below or exceeding a volatility of the share price within a range of 10% to 16% on a medium to long-term average, similar to a portfolio consisting of 75% global Equity Markets and 25% Euro denominated Bond Markets.

Investment Restrictions

- Min. 70% of Sub-Fund assets are invested in Equities and/or Debt Securities in accordance with the Multi Asset Sustainability Strategy and/or in SFDR Target Funds
- Max. 30% of Sub-Fund assets may be invested in Emerging Markets
- Multi Asset Sustainability Strategy exclusion criteria apply. Sub-Fund's pre-contractual template describes all relevant information about the strategy's scope, details, and requirements and applied exclusion criteria
- Max. 20% of Sub-Fund assets may be invested in High-Yield Investments Type 1
- Max. 30% of Sub-Fund assets may be invested in UCITS and/or UCI
- Duration on NAV level: between minus 2 and 10 years
- VAG Investment Restriction applies
- GITA Restriction (Alternative 2) applies
- A Sub-Fund's Investment Manager uses total return swaps to generate positive or negative exposure to the respective asset classes (further information are disclosed in Appendix 7)
- Benchmark: none

IndexManagement Balance

Investment Objective

Long-term capital growth by investing in the global bond, equity and money markets predominantly via investment funds, ETFs, index funds and index futures. Overall, the goal is to achieve over the long-term a performance comparable to a balanced portfolio consisting of 40% global equity markets and 60% global bond markets.

Investment Restrictions

- Sub-Fund assets may be invested in UCITS and/or UCI on an unlimited basis
- Max. 60% of Sub-Fund assets may be invested in equity funds and equities
- Sub-Fund assets may be invested in Emerging Markets including target funds which are deemed to be "Emerging Market Funds" according to the Morningstar classification
- Sub-Fund assets may be invested in High-Yield Investments Type 1 including target fund investments which are deemed to be "High Yield Funds" according to the Morningstar classification
- Max. 100% Sub-Fund assets may be held in Deposits and/or may be invested in money market instruments and/or (up to 100% of Sub-Fund assets) may be invested in money market funds on a temporary basis for liquidity management and/or defensive purpose and/or any other exceptional circumstances, and if the investment manager considers it in the best interest of the Sub-Fund.
- Duration: not restricted
- Benchmark: 20% MSCI Europe Total Return Net + 16% MSCI World Excl. Europe Total Return Net + 15% BLOOMBERG Euro Aggregate Corporate Total Return + 15% BLOOMBERG Euro Aggregate Treasury Total Return + 15% BLOOMBERG US Corporate Investment Grade Total Return (hedged into EUR) + 15% BLOOMBERG US Treasury Total Return (hedged into EUR) + 4% MSCI Emerging Markets Total Return Net. Degree of Freedom: material. Expected Overlap: minor

IndexManagement Chance

Investment Objective

Long-term capital growth by investing in the global bond, equity and money markets predominantly via investment funds, ETFs, index funds and index futures. Overall, the goal is to achieve over the long-term a performance comparable to a balanced portfolio consisting of 80% global equity markets and 20% global bond markets.

Investment Restrictions

- Sub-Fund assets may be invested in UCITS and/or UCI on an unlimited basis
- Max. 70% of Sub-Fund assets are invested in bond funds and debt securities
- Min. 30% of Sub-Fund assets are invested in equity funds and equities

- Sub-Fund assets may be invested in Emerging Markets including target funds which are deemed to be "Emerging Market Funds" according to the Morningstar classification
- Sub-Fund assets may be invested in High-Yield Investments Type 1 including target fund investments which are deemed to be "High Yield Funds" according to the Morningstar classification
- Max. 70% Sub-Fund assets may be held in Deposits and/or may be invested in in money market instruments and/or (up to 70% of Sub-Fund assets) may be invested in Money Market Funds on a temporary basis for liquidity management and/or defensive purpose and/or any other exceptional circumstances, and if the investment manager considers it in the best interest of the Sub-Fund.
- Duration: not restricted
- GITA Restriction (Alternative 2) applies
- Benchmark: 40% MSCI Europe Total Return Net + 32% MSCI World Excl. Europe Total Return Net + 8% MSCI Emerging Markets Total Return Net + 5% BLOOMBERG Euro Aggregate Corporate Total Return + 5% BLOOMBERG Euro Aggregate Treasury Total Return + 5% BLOOMBERG US Corporate Investment Grade Total Return (hedged into EUR) + 5% BLOOMBERG US Treasury Total Return (hedged into EUR). Degree of Freedom: material. Expected Overlap: minor

IndexManagement Substanz

Investment Objective

Long-term capital growth by investing in the global bond, equity and money markets predominantly via investment funds, ETFs, index funds and index futures. Overall, the goal is to achieve over the long-term a performance comparable to a balanced portfolio consisting of 20% global equity markets and 80% global bond markets.

Investment Restrictions

- Sub-Fund assets may be invested in UCITS and/or UCI on an unlimited basis
- Max. 30% of Sub-Fund assets may be invested in equity funds and equities
- Sub-Fund assets may be invested in Emerging Markets including target funds which are deemed to be "Emerging Market Funds" according to the Morningstar classification
- Sub-Fund assets may be invested in High-Yield Investments Type 1 including target fund investments which are deemed to be "High Yield Funds" according to the Morningstar classification
- Max. 100% Sub-Fund assets may be held in Deposits and/or may be invested in in money market instruments and/or (up to 100% of Sub-Fund assets) may be invested in Money Market Funds on a temporary basis for liquidity management and/or defensive purpose and/or any other exceptional circumstances, and if the investment manager considers it in the best interest of the Sub-Fund.
- Duration: not restricted
- Benchmark: 20% BLOOMBERG Euro Aggregate Corporate Total Return + 20% BLOOMBERG Euro Aggregate Treasury Total Return + 20% BLOOMBERG US Corporate Investment Grade Total Return (hedged into EUR) + 20% BLOOMBERG US Treasury Total Return (hedged into EUR) + 10% MSCI Europe Total Return Net + 8% MSCI World Excl. Europe Total Return Net + 2% MSCI Emerging Markets Total Return Net. Degree of Freedom: material. Expected Overlap: minor

IndexManagement Wachstum

Investment Objective

Long-term capital growth by investing in the global bond, equity and money markets predominantly via investment funds, ETFs, index funds and index futures. Overall, the goal is to achieve over the long-term a performance comparable to a balanced portfolio consisting of 60% global equity markets and 40% global bond markets.

Investment Restrictions

- Sub-Fund assets may be invested in UCITS and/or UCI on an unlimited basis
- Max. 90% of Sub-Fund assets may be invested in equity funds and equities
- Max. 75% of Sub-Fund assets are invested in bond funds and debt securities
- Sub-Fund assets may be invested in Emerging Markets including target funds which are deemed to be "Emerging Market Funds" according to the Morningstar classification
- Sub-Fund assets may be invested in High-Yield Investments Type 1 including target fund investments which are deemed to be "High Yield Funds" according to the Morningstar classification
- Max. 75% Sub-Fund assets may be held in Deposits and/or may be invested in in money market instruments and/or (up to 75% of Sub-Fund assets) may be invested in Money Market Funds on a temporary basis for liquidity management and/or defensive purpose and/or any other exceptional circumstances, and if the investment manager considers it in the best interest of the Sub-Fund.
- Duration: not restricted
- GITA Restriction (Alternative 2) applies
- Benchmark: 30% MSCI Europe Total Return Net + 24% MSCI World Excl. Europe Total Return Net + 10% BLOOMBERG Euro Aggregate Corporate Total Return + 10% BLOOMBERG Euro Aggregate Treasury Total Return + 10% BLOOMBERG US Corporate Investment Grade Total Return (hedged into EUR) + 10% BLOOMBERG US Treasury Total Return (hedged into EUR) + 6% MSCI Emerging Markets Total Return Net. Degree of Freedom: material. Expected Overlap: minor

4. Funds of Funds

The principles set out in the “General Part” are supplemented by the following principles and limits which exclusively apply to all Fund of Funds Sub-Funds unless otherwise stated in a Fund of Funds’ individual Investment Restrictions:

- A Sub-Fund’s Investment Manager follows, unless otherwise stated in a Sub-Fund’s investment objective (or in the investment restriction), always an active management approach (as mentioned in Appendix 1, Part A, No. 19).
- Min. 70% of Sub-Fund assets are invested in UCITS and/or UCI in accordance with the investment objective.
- Less than 30% of Sub-Fund assets may be invested in UCITS and/or UCI other than described in the investment objective.
- Less than 30% of Sub-Fund assets may be invested in Equities and/or Debt Securities in accordance with the investment objective and/or other than described in the investment objective.
- Max. 20% of Sub-Fund assets may be invested in ABS and/or MBS.
- Max. 10% of Sub-Fund assets may be invested in contingent convertible bonds.
- Max. 30% Sub-Fund assets may be invested in Money Market Funds and/or may be held in time deposits and/or (up to 20% of Sub-Fund assets) in deposits at sight and/or be invested in Money Market Instruments for liquidity management and/or defensive purpose and/or any other exceptional circumstances, and if the investment manager considers it in the best interest of the Sub-Fund.
- Where a country, region and/or market is referred to in the investment objective (or in the investment restriction), a Sub-Fund will (or will not) make investments which have exposure or connection to such country, region and/or markets. Such investments include Debt Securities that are issued or guaranteed by governments, municipalities, agencies, supra-nationals, central, regional, or local authority and companies of (including those that generate a predominant share of their sales or their profits in) such country, region and/or market as well as companies that are under common management or control of or have substantial direct or indirect participation in the foregoing companies.
- Where a country, region and/or market is referred to in the investment objective (or in the investment restriction), a Sub-Fund will (or will not) make investments which have exposure or connection to such country, region, and/or markets. Such investments include Equities of companies listed on a Regulated Market or incorporated, with a registered office or principal place of business, or that generate a predominant share of sales or profits in such country, region, or market, as well as companies under common management or control of, or have substantial direct or indirect participation in, the foregoing companies.
- A Benchmark is always used for a Sub-Fund’s Performance Measures if not otherwise referred to in the Sub-Fund’s individual investment restrictions. A Benchmark may be used also for a Sub-Fund’s Portfolio Composition, where such case is explicitly referred to in the Sub-Fund’s individual investment restrictions. In both cases the Investment Manager’s aim is to outperform the Benchmark. A Sub-Fund’s Benchmark (and in the case that such Benchmark is explicitly used for a Sub-Fund’s Portfolio Composition), and the Investment Manager’s Degree of Freedom to deviate from the Benchmark and the expected overlap between the Sub-Fund’s invested securities and the constituents of its Benchmark are referred to, unless not applicable, in a Sub-Fund’s individual Investment Restrictions. (Please refer to Appendix 1, Part A, No. 19)

Allianz ActInvest Balanced

Investment Objective

Long-term capital growth and income by investing in a broad range of asset classes, in particular in the global bond-, equity-, alternative- and money markets. The Sub-Fund achieves its investment objective by investing in investment funds (including internal SFDR Target Funds) with different regional focuses from a global investment universe. Overall, the goal is to achieve over the medium-term a performance comparable to a balanced portfolio consisting of global Equity Markets and Euro Bond Markets. The assessment of the volatility of the capital markets by the Investment Manager is an important factor in this process, with the aim of typically not falling below or exceeding a volatility of the Share price within a range of 6% to 12% on a medium to long-term average.

Investment Restrictions

- More than 70% of Sub-Fund assets are invested in (i) internal SFDR Target Funds and/or (ii) in Equities and/or in Debt Securities in accordance with the Multi Asset Sustainability Strategy (including exclusion criteria). Sub-Fund’s pre-contractual template describes all relevant information about the strategy’s scope, details, and requirements and applied exclusion criteria.
- Max. 35% of Sub-Fund assets may be invested in Emerging Markets. Included in this limit are target fund investments if the respective acquired target funds are deemed to be “Emerging Market Funds” according to the Morningstar classification
- Max. 25% of Sub-Fund assets may be invested in High-Yield Investments Type 1. Included in this limit are target fund investments if the respective acquired target funds are deemed to be “High Yield Funds” according to the Morningstar classification
- Max. 100% Sub-Fund assets may be invested in Money Market Funds and (up to 30% of Sub-Fund assets) may be held in Deposits and be invested in in money market instruments on a temporary basis for liquidity management and/or defensive purpose and/or any other exceptional circumstances, and if the investment manager considers it in the best interest of the Sub-Fund.
- Duration: between minus 2 and 10 years
- Benchmark: none

Allianz ActiveInvest Defensive

Investment Objective

Long-term capital growth and income by investing in a broad range of asset classes, in particular in the global bond-, equity-, alternative- and money markets. The Sub-Fund achieves its investment objective by investing in investment funds (including internal SFDR Target Funds) with different regional focuses from a global investment universe. Overall, the goal is to achieve over the medium-term a performance comparable to a defensive portfolio consisting of global Equity Markets and Euro Bond Markets. The assessment of the volatility of the capital markets by the Investment Manager is an important factor in this process, with the aim of typically not falling below or exceeding a volatility of the Share price within a range of 3% to 9% on a medium to long-term average.

Investment Restrictions

- More than 70% of Sub-Fund assets are invested in (i) internal SFDR Target Funds and/or (ii) in Equities and/or in Debt Securities in accordance with the Multi Asset Sustainability Strategy (including exclusion criteria). Sub-Fund's pre-contractual template describes all relevant information about the strategy's scope, details, and requirements and applied exclusion criteria.
- Max. 25% of Sub-Fund assets may be invested in Emerging Markets. Included in this limit are target fund investments if the respective acquired target funds are deemed to be "Emerging Market Funds" according to the Morningstar classification
- Max. 20% of Sub-Fund assets may be invested in High-Yield Investments Type 1. Included in this limit are target fund investments if the respective acquired target funds are deemed to be "High Yield Funds" according to the Morningstar classification
- Max. 100% Sub-Fund assets may be invested in Money Market Funds and (up to 30% of Sub-Fund assets) may be held in Deposits and be invested in in money market instruments on a temporary basis for liquidity management and/or defensive purpose and/or any other exceptional circumstances, and if the investment manager considers it in the best interest of the Sub-Fund.
- Duration: between minus 2 and 10 years
- Benchmark: none

Allianz ActiveInvest Dynamic

Investment Objective

Long-term capital growth and income by investing in a broad range of asset classes, in particular in the global bond-, equity-, alternative- and money markets. The Sub-Fund achieves its investment objective by investing in investment funds (including internal SFDR Target Funds) with different regional focuses from a global investment universe. Overall, the goal is to achieve over the medium-term a performance comparable to a dynamic portfolio consisting of global Equity Markets and Euro Bond Markets. The assessment of the volatility of the capital markets by the Investment Manager is an important factor in this process, with the aim of typically not falling below or exceeding a volatility of the Share price within a range of 10% to 18% on a medium to long-term average.

Investment Restrictions

- More than 70% of Sub-Fund assets are invested in (i) internal SFDR Target Funds and/or (ii) in Equities and/or in Debt Securities in accordance with the Multi Asset Sustainability Strategy (including exclusion criteria). Sub-Fund's pre-contractual template describes all relevant information about the strategy's scope, details, and requirements and applied exclusion criteria.
- Max. 50% of Sub-Fund assets may be invested in Emerging Markets. Included in this limit are target fund investments if the respective acquired target funds are deemed to be "Emerging Market Funds" according to the Morningstar classification
- Max. 30% of Sub-Fund assets may be invested in High-Yield Investments Type 1. Included in this limit are target fund investments if the respective acquired target funds are deemed to be "High Yield Funds" according to the Morningstar classification
- Max. 100% Sub-Fund assets may be invested in Money Market Funds and (up to 30% of Sub-Fund assets) may be held in Deposits and be invested in in money market instruments on a temporary basis for liquidity management and/or defensive purpose and/or any other exceptional circumstances, and if the investment manager considers it in the best interest of the Sub-Fund.
- Duration: between minus 2 and 10 years
- Benchmark: none

Allianz Alternative Investment Strategies

Investment Objective

Long-term capital growth by investing in global alternative investment strategies or alternative assets. The Sub-Fund will seek to achieve the investment objective primarily by investing in investment funds.

Investment Restrictions

- Min. 55% of Sub-Fund assets are invested in UCITS and/or UCI in accordance with the investment objective
- Max. 45% of Sub-Fund assets may be invested in UCITS and/or UCI other than described in the investment objective.
- Max. 45% of Sub-Fund assets may be invested in Equities and/or Debt Securities in accordance with the investment objective and/or other than described in the investment objective.
- Max. 45% Sub-Fund assets may be invested in Money Market Funds and may be held in Deposits and be invested in in money market instruments for liquidity management and/or defensive purpose and/or any other exceptional circumstances, and if the investment manager considers it in the best interest of the Sub-Fund.
- Sub-Fund assets may be invested in Emerging Markets and/or in target funds which are deemed to be "Emerging Market Funds" according to the Morningstar classification
- Sub-Fund assets may be invested in High-Yield Investments Type 1, including target fund investments if the respective acquired target funds are deemed to be "High Yield Funds" according to the Morningstar classification
- The Investment Manager focuses on the following types of strategies:

Equity Long / Short strategies

Strategies involving both long and short exposure to the equity market in an effort to take advantage of the relative / different price development of single stocks. The strategy universe is very broad, containing quantitative and fundamental strategies that either focus on a specific market or sector, or are widely diversified across different sectors. Both top-down and bottom-up approaches may be employed.

Credit Long / Short strategies

The long / short credit segment encompasses a broad diversity of credit strategies mainly implemented in the corporate bond market, via bonds, derivatives and cash. One common investment strategy is to benefit from price discrepancies between the securities of one or more issuers within the same sector or market segment. Strategies may vary in respect of credit-rating requirements, regional exposure and some may also effort to take advantage of event driven opportunities within the corporate bond market.

Event-Driven investment strategies

An event-driven investment strategy capitalizes on the opportunities inherent in specific corporate events. Such events include merger or acquisitions and special company situations.

An event driven investment strategy intends to benefit from inefficiencies in the market prices of companies which are subject to a specific corporate event. Such event can be merger activities, takeovers, tender offers and other corporate activities or any other special situation which can be broadly defined as any specific corporate event (also known as a "catalyst") that would have a direct impact to the securities issued by a specific company. For example, corporate spin-offs, share class exchanges and security issuances.

Alternative volatility strategies

An alternative volatility driven investment strategy invests in derivative financial instruments whose value is dependent on price fluctuations (volatility) typically on the equity market. As such variance swaps might be employed that rise in value, if the realized volatility (more precisely: the variance) is lower than the volatility implied in the swap agreement. The success of the investment strategy does not depend on the direction of the market trend but on the actual development of volatility relative to the implied one.

An option-based investment strategy is a particular form of a volatility strategy. It utilizes equity option spreads, typically buying and selling put options and call options including, without any limitation, on global equity indices, global equity index futures, global equity market related volatility indices, global equity market related volatility futures, and exchange traded funds. The objective of the option spreads is to create option based "profit zones" that upon expiration of the options will lead to a positive return for the strategy if the level of the underlying index (or other instrument) ends up within such profit zone.

Global Macro strategies

A global macro strategy features the broadest opportunity set of all liquid alternatives. They typically invest in a broad global universe of asset classes, such as equities, bonds (especially government bonds), currencies and commodities, with the primary aim of taking advantage of changes and trends on the global financial markets. As these strategies normally operate in liquid markets, exposure can be adjusted quickly and flexibly to market conditions.

Multi Strategy/ Multi-Asset/ Allocation strategies

These funds implement both directional and non-directional sub-strategies and have a largely unconstrained mandate to invest in a range of asset classes / sub-asset classes. As a result, these funds may have statistically significant betas to multiple asset classes / sub-asset classes (e.g., debt, equity, currencies and derivatives) but this may change over time.

Alternative assets

Alternative assets are investment which aim to have a low correlation to equities or bonds. Typical alternative asset classes are real estate, commodities or private equity.

- Benchmark: EURO SHORT-TERM RATE (€STR). Degree of Freedom: significant. Expected Overlap: not applicable

Allianz Best of Managers

Investment Objective

Long-term capital growth and income by investing in a broad range of asset classes, in particular in the global bond-, equity-, alternative- and money markets. The Sub-Fund seeks to achieve its investment objective by investing in internal and/or external investment funds with different regional focuses from a global investment universe.

Investment Restrictions

- Max. 60% of Sub-Fund assets may be invested in Emerging Markets. Included in this limit are target fund investments if the respective acquired target funds are deemed to be "Emerging Market Funds" according to the Morningstar classification
- Max. 60% of Sub-Fund assets may be invested in High-Yield Investments Type 1. Included in this limit are target fund investments if the respective acquired target funds are deemed to be "High Yield Funds" according to the Morningstar classification
- Max. 100% Sub-Fund assets may be invested in Money Market Funds and (up to 30% of Sub-Fund assets) may be held in Deposits and be invested in money market instruments on a temporary basis for liquidity management and/or defensive purpose and/or any other exceptional circumstances, and if the investment manager considers it in the best interest of the Sub-Fund. Duration: between minus 2 and 10 years
- Benchmark: none

Allianz Coupon Select Plus VI

Investment Objective

Long-term capital growth and income by investing in a broad range of asset classes, in particular in the global bond-, equity-, alternative- and money markets. The Sub-Fund achieves its investment objective by investing in internal investment funds with different regional focuses from a global investment universe.

Investment Restrictions

- Max. 60% of Sub-Fund assets may be invested in Emerging Markets. Included in this limit are target fund investments if the respective acquired target funds are deemed to be "Emerging Market Funds" according to the Morningstar classification
- Max. 30% of Sub-Fund assets may be invested in High-Yield Investments Type 1. Included in this limit are target fund investments if the respective acquired target funds are deemed to be "High Yield Funds" according to the Morningstar classification
- Max. 100% Sub-Fund assets may be invested in Money Market Funds and (up to 30% of Sub-Fund assets) may be held in Deposits and be invested in in money market instruments on a temporary basis for liquidity management and/or defensive purpose and/or any other exceptional circumstances, and if the investment manager considers it in the best interest of the Sub-Fund.
- Duration: between minus 2 and 10 years
- Benchmark: none

Allianz Green Future

Investment Objective

Long-term capital growth and income by investing in a broad range of asset classes, in particular in the global bond-, global equity-, and money markets. The Sub-Fund achieves its investment objective by investing in internal SFDR Target Funds.

Investment Restrictions

- Min. 90% of Sub-Fund assets are invested in internal SFDR Target Funds and/or in Equities and/or Debt Securities in accordance with the Multi Asset Sustainability Strategy (including exclusion criteria). Sub-Fund's pre-contractual template describes all relevant information about the strategy's scope, details, and requirements and applied exclusion criteria.
- Min. 70% of Sub-Fund assets are invested in internal SFDR Target Funds in accordance with the Investment Objective
- Sub-Fund assets may not be invested in UCITS / UCI other than described in the investment objective
- Max. 47,5% of Sub-Fund assets may be invested in Equity. Included in this limit are target fund investments if the respective acquired target funds are deemed to be "Equity Funds" according to the Morningstar classification
- Max. 30% of Sub-Fund assets may be invested in Equities and/or Debt Securities in accordance with the Multi Asset Sustainability Strategy.
- Max. 40% of Sub-Fund assets may be invested in Emerging Markets. Included in this limit are target fund investments if the respective acquired target funds are deemed to be "Emerging Market Funds" according to the Morningstar classification
- Max. 30% of Sub-Fund assets may be invested in High-Yield Investments Type 1. Included in this limit are target fund investments if the respective acquired target funds are deemed to be "High Yield Funds" according to the Morningstar classification
- Max. 50% Sub-Fund assets may be invested in Money Market Funds and, up to 30% of Sub-Fund assets, may be held in Deposits and be invested in in money market instruments on a temporary basis for liquidity management and/or defensive purpose and/or any other exceptional circumstances, and if the investment manager considers it in the best interest of the Sub-Fund.
- Duration: between minus 2 and 10 years
- Benchmark: none

Allianz Selection Alternative

Investment Objective

Long term capital growth by investing in global alternative investment strategy funds and/or alternative asset funds.

Investment Restrictions

- Sub-Fund assets may be invested in target funds which are deemed to be "Emerging Market Funds" according to the Morningstar classification
- Sub-Fund assets may be invested in High-Yield Investments Type 1 including target fund investments if the respective acquired target funds are deemed to be "High Yield Funds" according to the Morningstar classification
- Sub-Fund assets may not be invested in Equities and/or ABS/MBS
- The Investment Manager focuses on the following types of strategies:

Equity Long / Short strategies

Strategies involving both long and short exposure to the equity market in an effort to take advantage of the relative / different price development of single stocks. The strategy universe is very broad, containing quantitative and fundamental strategies that either focus on a specific market or sector, or are widely diversified across different sectors. Both top-down and bottom-up approaches may be employed.

Credit Long / Short strategies

The long / short credit segment encompasses a broad diversity of credit strategies mainly implemented in the corporate bond market, via bonds, derivatives and cash. One common investment strategy is to benefit from price discrepancies between the securities of one or more issuers within the same sector or market segment. Strategies may vary in respect of credit-rating requirements, regional exposure and some may also effort to take advantage of event driven opportunities within the corporate bond market.

Event-Driven investment strategies

An event-driven investment strategy capitalizes on the opportunities inherent in specific corporate events. Such events include merger or acquisitions and special company situations. An event driven investment strategy intends to benefit from inefficiencies in the market prices of companies which are subject to a specific corporate event. Such event can be merger activities, takeovers, tender offers and other corporate activities or any other special situation which can be broadly defined as any specific corporate event (also known as a "catalyst") that would have a direct impact to the securities issued by a specific company. For example, corporate spin-offs, share class exchanges and security issuances.

Alternative volatility strategies

An alternative volatility driven investment strategy invests in derivative financial instruments whose value is dependent on price fluctuations (volatility) typically on the equity market. As such variance swaps might be employed that rise in value, if the realized volatility (more precisely: the variance) is lower than the volatility implied in the swap agreement. The success of the investment strategy does not depend on the direction of the market trend but on the actual development of volatility relative to the implied one.

An option-based investment strategy is a particular form of a volatility strategy. It utilizes equity option spreads, typically buying and selling put options and call options including, without any limitation, on global equity indices, global equity index futures, global equity market related volatility indices, global equity market related volatility futures, and exchange traded funds. The objective of the option spreads is to create option based "profit zones" that upon expiration of the options will lead to a positive return for the strategy if the level of the underlying index (or other instrument) ends up within such profit zone.

Global Macro strategies

A global macro strategy features the broadest opportunity set of all liquid alternatives. They typically invest in a broad global universe of asset classes, such as equities, bonds (especially government bonds), currencies and commodities, with the primary aim of taking advantage of changes and trends on the global financial markets. As these strategies normally operate in liquid markets, exposure can be adjusted quickly and flexibly to market conditions.

Multi-Asset Allocation strategies

Those strategies implement sub-strategies both directional and non-directional and have a largely unconstrained mandate making it possible to invest in a range of asset categories / sub-categories assets. As a result, those strategies may show high betas in relation to several asset categories / sub-asset categories (e.g., debt securities, stocks, currencies, and derivatives), but this can evolve over time.

Alternative assets

Alternative assets are investment which aim to have a low correlation to equities or bonds. Typical alternative asset classes are real estate, commodities or private equity.

- Benchmark: none

Allianz Selection Fixed Income

Investment Objective

Long term capital growth by investing in global bond- and money market funds.

Investment Restrictions

- Sub-Fund assets may be invested in target funds which are deemed to be "Emerging Market Funds" according to the Morningstar classification
- Sub-Fund assets may be invested in High-Yield Investments Type 1 included in target fund investments if the respective acquired target funds are deemed to be "High Yield Funds" according to the Morningstar classification
- Max. 30% Sub-Fund assets may be held in Deposits and may be invested in in money market instruments for liquidity management
- Sub-Fund assets may not be invested in Equities and/or ABS/MBS
- Benchmark: none

Allianz Selection Small and Mid Cap Equity

Investment Objective

Long term capital growth by investing in European equity markets funds with a focus on smaller and midsized companies.

Investment Restrictions

- Sub-Fund assets may be invested in Emerging Markets included in target funds which are deemed to be "Emerging Market Funds" according to the Morningstar classification
- Sub-Fund assets may be invested in High-Yield Investments Type 1 included in target fund investments if the respective acquired target funds are deemed to be "High Yield Funds" according to the Morningstar classification
- Min. 90% of Sub-Fund assets are invested in UCITS and/or UCI thereof at least 70% of Sub-Fund assets are invested in UCITS and/or UCI in accordance with the investment objective.
- Max. 10% of Sub-Fund assets may be invested in Equities or Debt Securities which can qualify as Social Economy Assets
- Max. 10% of Sub-Fund assets may be invested in ABS and/or MBS
- Max. 10% of Sub-Fund assets may be held in Deposits and be invested in money market instruments.
- Max. 30% of Sub-fund assets may be invested in Money Market Funds for liquidity management and/or defensive purposes and/or any other exceptional circumstances, and if the investment manager considers it in the best interest of the Sub-Fund
- VAG Investment Restriction applies
- Benchmark: none

Allianz Trend and Brands

Investment Objective

Long-term capital growth and income by investing in a broad range of asset classes, in particular in the global bond-, equity-, alternative- and money markets. The Sub-Fund achieves its investment objective by investing in investment funds with different regional focuses from a global investment universe. Overall, the goal is to achieve over the medium-term a performance comparable to a balanced portfolio consisting of global equity markets and global bond markets. While at fund launch the goal is to achieve over the medium-term a performance comparable to a balanced portfolio consisting predominantly of bond and/ or money markets, over a time of approximately 30 months after fund launch the goal will be gradually shifted to achieve over the medium-term a performance comparable to a balanced portfolio consisting predominantly of equity and/ or alternative markets. In selecting equity funds a focus will be put on thematic or sector equity funds.

Investment Restrictions

- Max. 60% of Sub-Fund assets may be invested in Emerging Markets. Included in this limit are target fund investments if the respective acquired target funds are deemed to be "Emerging Market Funds" according to the Morningstar classification
- Max. 30% of Sub-Fund assets may be invested in High-Yield Investments Type 1. Included in this limit are target fund investments if the respective acquired target funds are deemed to be "High Yield Funds" according to the Morningstar classification.
- Min. 10% of Sub-Fund assets may be invested in Equity Funds.
- Max. 100% Sub-Fund assets may be invested in Money Market Funds and (up to 30% of Sub-Fund assets) may be held in Deposits and be invested in in money market instruments on a temporary basis for liquidity management and/or defensive purpose and/or any other exceptional circumstances, and if the investment manager considers it in the best interest of the Sub-Fund.
- Duration on NAV level: between minus 2 and 10 years
- Benchmark: none

5. Target Maturity Funds

The principles set out in the “General Part” are supplemented by the following principles and limits which exclusively apply to all Target Maturity Sub-Funds unless otherwise stated in a Target Maturity Sub-Fund’s individual Investment Restrictions:

- A Sub-Fund’s Investment Manager follows, unless otherwise stated in a Sub-Fund’s investment objective (or in the investment restriction), always an active management approach (as mentioned in Appendix 1, Part A, No. 19).
- Target Maturity Funds have been created for a limited period (the “Maturity Date”) and will be automatically put into liquidation at the date mentioned in their investment objective (the “Liquidation Date”). For such Sub-Funds, the date on which distributions to Shareholders will begin (the “Distribution Date”) is also mentioned in the relevant Sub-Fund’s investment objective.
- Other Target Maturity Funds have a rolling target maturity date which is mentioned in the relevant Sub-Fund’s investment objective.
- For Target Maturity Funds which have been created for a limited period, the portfolio structure is built over time by the Sub-Fund’s investment manager and regarded as final (within a period of max six months after the Sub-Fund’s launch date) when those assets which the Sub-Fund’s investment manager believes are necessary to achieve the Sub-Fund’s investment objective have been acquired (the “Starting Allocation”). In building the Sub-Fund’s portfolio, the Sub-Fund’s investment manager intends to acquire primarily Debt Securities whose maturity or call date is generally compatible with the Sub-Fund’s Maturity Date and intends to hold such Debt Securities – after the Starting Allocation has been regarded as final - until the Sub-Fund’s Maturity Date. Such Sub-Fund is permitted to exceed certain investment restrictions after the Starting Allocation has been established if such breach occurs through changes in the value of the assets held in the Sub-Fund. In these cases, the Sub-Fund’s investment manager is not obliged to actively seek to comply with the relevant investment restrictions if, in the investment manager’s opinion, this would alter the portfolio structure that was established through the Starting Allocation. If more shares of the Sub-Fund are issued than redeemed, additional assets may be acquired to maintain the proportions of the Starting Allocation. If after acquisition, an asset loses its rating that existed at the time of acquisition or is being downgraded (even from Investment Grade to High-Yield Investments Type 1) such asset may remain in the Sub-Fund. This could result in the Sub-Fund exceeding certain investment restrictions. The provisions set out in this bullet point do not apply to a Target Maturity Sub-Fund’s individual Investment Restrictions resulting from the application of a specific Investment Strategy as mentioned in Appendix 1, Part B (Potential use of a specific Investment Strategy).
- Sub-Fund assets are primarily invested in Debt Securities as described in the investment objective.
- Less than 30% of Sub-Fund assets may be invested in Debt Securities other than described in the investment objective.
- Max. 100% of Sub-Fund assets may be held in time deposits and/or (up to 20% of Sub-Fund assets) in deposits at sight and/or invested in Money Market Instruments and/or (up to 10% of Sub-Fund assets) in money market funds on a temporary basis for liquidity management and/or for defensive purpose and/or any other exceptional circumstances, and/or if the investment manager otherwise considers it in the best interest of the Sub-Fund.
- Max. 20% of Sub-Fund assets may be invested in ABS and/or MBS.
- Max. 10% of Sub-Fund assets may be invested in contingent convertible bonds.
- Max. 10% of Sub-Fund assets may be invested in preference shares.
- Max. 10% of Sub-Fund assets may be invested in UCITS and/or UCI.
- Where a country, region and/or market is referred to in the investment objective (or in the investment restriction), a Sub-Fund will (or will not) make investments which have exposure or connection to such country, region and/or markets. Such investments include Debt Securities that are issued or guaranteed by governments, municipalities, agencies, supra-nationals, central, regional, or local authority and companies of (including those that generate a predominant share of their sales or their profits in) such country, region, and/or market as well as companies that are under common management or control of or have substantial direct or indirect participation in the foregoing companies.
- Sub-Fund assets may be invested in Equities and comparable securities or rights in the exercise of subscription, conversion and option rights on investments such as convertible bonds, contingent convertible bonds and bonds with warrants, but they must be sold within twelve months from the date of acquisition. Up to 5% of Sub-Fund assets as described in the aforementioned meaning may be invested longer than twelve months if the investment manager considers it in the best interest of the Sub-Fund.
- A Benchmark is always used for a Sub-Fund’s Performance Measures if not otherwise referred to in the Sub-Fund’s individual investment restrictions. A Benchmark may be used also for a Sub-Fund’s Portfolio Composition, where such case is explicitly referred to in the Sub-Fund’s individual investment restrictions. In both cases the Investment Manager’s aim is to outperform the Benchmark. A Sub-Fund’s Benchmark (and in the case that such Benchmark is explicitly used for a Sub-Fund’s Portfolio Composition), and the Investment Manager’s Degree of Freedom to deviate from the Benchmark and the expected overlap between the Sub-Fund’s invested securities and the constituents of its Benchmark are referred to, unless not applicable, in a Sub-Fund’s individual Investment Restrictions. (Please refer to Appendix 1, Part A, No. 19)

Allianz Laufzeitfonds

Investment Objective

Market-oriented return by investing in Debt Securities of Global bond markets (Euro denominated) in accordance with the Sustainability Key Performance Indicator Strategy (Relative) ("KPI Strategy (Relative)"). In this context, the aim is to outperform the Sub-Fund's Sustainability KPI compared to Sub-Fund's Benchmark to achieve the investment objective.

Maturity Date: Planned for maximum five years from Sub-Fund's launch date.

Liquidation Date: Planned for maximum five years from Sub-Fund's launch date.

Distribution Date: Starting on the next Dealing Date following the Maturity Date.

Investment Restrictions

- Sub-Fund assets are primarily invested in Debt Securities as described in the investment objective
- Min. 80% of Sub-Fund's portfolio shall be evaluated by the "Weighted Average GHG Intensity (Sales)" (the "Sustainability KPI"). Portfolio in this respect does not comprise derivatives and instruments that are non-evaluated by nature (e.g., cash and Deposits). This Investment Restriction will be adhered to even if it requires a change of the Sub-Fund's Starting Allocation.
- KPI Strategy (Relative) (including exclusion criteria) applies
- Sub-Fund's investment objective shall be achieved by a minimum outperformance of 20% of Sub-Fund's Sustainability KPI compared to the Weighted Average GHG Intensity (Sales) of Sub-Fund's Benchmark. This Investment Restriction will be adhered to even if it requires a change of the Sub-Fund's Starting Allocation.
- Max. 50% of Sub-Fund assets may be invested in High-Yield Investments Type 1 until the Starting Allocation has been established
- Max. 10% of Sub-Fund assets are invested in Emerging Markets until the Starting Allocation has been established
- Max. 10% non-EUR Currency Exposure
- Duration: between zero and 6 years
- Benchmark (only used in connection with the Sub-Fund's Sustainability KPI): ICE BOFAML Euro Corporate (ICE Indices incorporate transaction costs into their calculation).
- Degree of Freedom: significant. Overlap: minor

Allianz Target Maturity Euro Bond I

Investment Objective

Market-oriented return by investing in Debt Securities of Global bond markets (Euro denominated) in accordance with the Sustainability Key Performance Indicator Strategy (Relative) ("KPI Strategy (Relative)"). In this context, the aim is to outperform the Sub-Fund's Sustainability KPI compared to Sub-Fund's Benchmark to achieve the investment objective.

Maturity Date: 17 May 2026

Liquidation Date: 17 May 2026

Distribution Date: Starting on the next Dealing Date following the Maturity Date.

Sub-Fund's launch date: 17 May 2023

Investment Restrictions

- Sub-Fund assets are primarily invested in Debt Securities as described in the investment objective
- Min. 80% of Sub-Fund's portfolio shall be evaluated by the "Weighted Average GHG Intensity (Sales)" (the "Sustainability KPI"). Portfolio in this respect does not comprise derivatives and instruments that are non-evaluated by nature (e.g., cash and Deposits). This Investment Restriction will be adhered to even if it requires a change of the Sub-Fund's Starting Allocation.
- KPI Strategy (Relative) (including exclusion criteria) applies
- Sub-Fund's investment objective shall be achieved by a minimum outperformance of 20% of Sub-Fund's Sustainability KPI compared to the Weighted Average GHG Intensity (Sales) of Sub-Fund's Benchmark. This Investment Restriction will be adhered to even if it requires a change of the Sub-Fund's Starting Allocation.
- Max. 40% of Sub-Fund assets may be invested in High-Yield Investments Type 1 until the Starting Allocation has been established
- Max. 30% of Sub-Fund assets are invested in Emerging Markets until the Starting Allocation has been established
- Max. 10% non-EUR Currency Exposure
- Duration: between zero and 6 years
- Benchmark (only used in connection with the Sub-Fund's Sustainability KPI): ICE BOFAML Euro Corporate (ICE Indices incorporate transaction costs into their calculation). Degree of Freedom: significant. Overlap: minor

Allianz Target Maturity Euro Bond II

Investment Objective

Market-oriented return by investing in Debt Securities of Global bond markets (Euro denominated) in accordance with the Sustainability Key Performance Indicator Strategy (Relative) ("KPI Strategy (Relative)"). In this context, the aim is to outperform the Sub-Fund's Sustainability KPI compared to Sub-Fund's Benchmark to achieve the investment objective.

Maturity Date: 29 October 2027

Liquidation Date: 29 October 2027

Distribution Date: Starting on the next Dealing Date following the Maturity Date.

Sub-Fund's launch date: 4 September 2023

Investment Restrictions

- Sub-Fund assets are primarily invested in Debt Securities as described in the investment objective
- Min. 80% of Sub-Fund's portfolio shall be evaluated by the "Weighted Average GHG Intensity (Sales)" (the "Sustainability KPI"). Portfolio in this respect does not comprise derivatives and instruments that are non-evaluated by nature (e.g., cash and Deposits). This Investment Restriction will be adhered to even if it requires a change of the Sub-Fund's Starting Allocation.
- KPI Strategy (Relative) (including exclusion criteria) applies
- Sub-Fund's investment objective shall be achieved by a minimum outperformance of 20% of Sub-Fund's Sustainability KPI compared to the Weighted Average GHG Intensity (Sales) of Sub-Fund's Benchmark. This Investment Restriction will be adhered to even if it requires a change of the Sub-Fund's Starting Allocation.
- Max. 40% of Sub-Fund assets may be invested in High-Yield Investments Type 1 until the Starting Allocation has been established
- Max. 30% of Sub-Fund assets are invested in Emerging Markets until the Starting Allocation has been established
- Max. 10% non-EUR Currency Exposure
- Duration: between zero and 6 years
- Benchmark (only used in connection with the Sub-Fund's Sustainability KPI): ICE BOFAML Euro Corporate (ICE Indices incorporate transaction costs into their calculation). Degree of Freedom: significant. Overlap: minor

6. Alternative Funds

The principles set out in the “General Part” are supplemented by the following principles and limits which exclusively apply to all Alternative Sub-Funds unless otherwise stated in an Alternative Sub-Fund’s individual Investment Restrictions:

- A Sub-Fund’s Investment Manager follows, unless otherwise stated in a Sub-Fund’s investment objective (or in the investment restriction), always an active management approach (as mentioned in Appendix 1, Part A, No. 19).
- The key feature of an Alternative Fund is to follow and to participate in a specific investment strategy (the “Strategy”) which may be implemented by using a derivative structure. Information about the current state of the Strategy can be obtained on the website www.allianzglobalinvestors.com
- Implementation of the Strategy
 - a) In some Alternative Funds the Strategy is implemented by using a derivative structure, in particular swaps, on a cash component and the positive or negative performance resulting from the Strategy’s investment in securities according to the Strategy’s Description (the “Transfer of the Strategy’s performance”). The Investment Manager exchanges a regular variable payment from the Sub-Fund against a participation in the performance of the Strategy. The Strategy’s performance may also be negative, which would then result in an additional payment from the Sub-Fund to the respective counterparty of the derivative structure. The overall derivative structure will be implemented with at least one counterparty. Such counterparty must comply with the general requirements of the Investment Manager for counterparty selection. Through regular and ad hoc resets of the derivative structure it will be ensured that the maximum counterparty risk of the selected counterparty will not exceed 10% of the Sub-Fund’s assets. The counterparty assumes no discretion over the composition or management of the Strategy. The Strategy will be fully implemented within one month after Sub-Fund’s launch. Prior to full implementation of the Strategy, investor’s participation in the Strategy’s performance may be limited or completely excluded.
 - b) In other Alternative Funds the Strategy is implemented directly in the Sub-Fund’s portfolio by the Investment Manager by using all eligible instruments as described in the General Investment Principles which includes the use of derivatives (including, but not limited to investment purposes) in order to achieve the Sub-Fund’s investment objective (“Direct Implementation of Strategy”).
- Min. 70% of Sub-Fund assets are invested in Debt Securities and/or Equities and/or other asset classes in accordance with the investment objective
- Less than 30% of Sub-Fund assets may be invested in Debt Securities and/or Equities and/or other asset classes other than described in the investment objective
- Max. 100% Sub-Fund assets may be held in time deposits and/or (up to 20% of Sub-Fund assets) in deposits at sight and/or invested in Money Market Instruments and/or (up to 10% of Sub-Fund assets) in money market funds on a temporary basis for liquidity management and/or defensive purpose and/or any other exceptional circumstances, and/or if the investment manager otherwise considers it in the best interest of the Sub-Fund.
- Max. 20% of Sub-Fund assets may be invested in ABS and/or MBS.
- Max. 10% of Sub-Fund assets may be invested in contingent convertible bonds.
- Max. 10% of Sub-Fund assets may be invested in UCITS and/or UCI.
- Where a country, region and/or market is referred to in the Investment Objective (or in the Investment Restriction), a Sub-Fund will (or will not) make investments which have exposure or connection to such country, region and/or markets. Such investments include Debt Securities that are issued or guaranteed by governments, municipalities, agencies, supra-nationals, central, regional, or local authority and companies of (including those that generate a predominant share of their sales or their profits in) such country, region and/or market as well as companies that are under common management or control of or have substantial direct or indirect participation in the foregoing companies.
- Sub-Fund assets may be invested in Equities and comparable securities or rights in the exercise of subscription, conversion and option rights on investments such as convertible bonds, contingent convertible bonds and bonds with warrants, but they must be sold within twelve months from the date of acquisition. Up to 5% of Sub-Fund assets as described in the aforementioned meaning may be invested longer than twelve months if the investment manager considers it in the best interest of the Sub-Fund.
- A Benchmark is always used for a Sub-Fund’s Performance Measures if not otherwise referred to in the Sub-Fund’s individual investment restrictions. A Benchmark may be used also for a Sub-Fund’s Portfolio Composition, where such case is explicitly referred to in the Sub-Fund’s individual investment restrictions. In both cases the Investment Manager’s aim is to outperform the Benchmark. A Sub-Fund’s Benchmark (and in the case that such Benchmark is explicitly used for a Sub-Fund’s Portfolio Composition), and the Investment Manager’s Degree of Freedom to deviate from the Benchmark and the expected overlap between the Sub-Fund’s invested securities and the constituents of its Benchmark are referred to, unless not applicable, in a Sub-Fund’s individual Investment Restrictions. (Please refer to Appendix 1, Part A, No. 19)

Allianz Dynamic Allocation Plus Equity

Investment Objective

The investment policy aims at long-term capital growth by investing in a broad range of asset classes, taking advantage of the risk and return opportunities of both, the global Equity Markets and a Multi Asset Long / Short approach.

Investment Restrictions

- 1) **Description of the Investment Manager’s strategy**
The Sub-Fund realizes a long global equity exposure by investing in a portfolio of various asset classes including, but not limited to, Global Equities and short-term global government bonds.

Using all or a portion of the underlying portfolio as collateral, the Sub-Fund utilizes a proprietary model, the Multi Asset Long/Short approach, to allocate assets to different asset classes (e.g., Equities, REITs, commodities, sovereign bonds, covered bonds, inflation-linked bonds, high yield bonds, Emerging Markets bonds, various currencies) by investing in certain assets ("Long Positions"), while selling certain assets ("Short Positions"), together the "Multi Asset Long/Short Approach". The Multi Asset Long/Short Approach only considers such asset classes for which the respective exposure can be generated by acquiring assets or using techniques and instruments which are deemed to be sufficiently liquid, in order to target at daily liquidity of the Sub-Fund. The Investment Manager may also assume separate currency positions, corresponding derivatives and foreign currencies, even if the Sub-Fund does not include any assets denominated in these respective currencies. The Multi Asset Long/Short Approach aims to generate a leveraged risk exposure through the use of derivatives in comparison to a portfolio which would allocate each asset class by the acquisition of assets without the use of derivatives.

2) Implementation of the Multi Asset Long/Short approach as described under letter b) of asset class description

The Multi Asset Long/Short Approach ("Strategy") is implemented by the Investment Manager which has full discretion as to how to generate positive (Long Positions) as well as negative exposure (Short positions) of the respective asset classes. The Strategy's gross exposure (long positions plus short positions) can be up to 5 times the Sub-Fund's Net Asset Value (NAV). Such Exposure - Long Positions and/or Short Positions - can be generated by either acquiring or selling assets by using derivatives. Such derivatives may include, but are not limited to the use of futures, forward contracts, options, and swaps such as equity swap and total return swaps. If total return swaps are used, the respective counterparty assumes no discretion over the respective underlying of the total return swap. Further information is disclosed in Appendix 7. The Investment Manager may use total return swaps to generate positive or negative exposure to the respective asset classes. By using total return swaps, the Investment Manager exchanges a regular variable payment from the Fund against a participation in the positive or negative performance of the respective asset classes. This performance may also be negative, which would then result in an additional payment from the Fund to the respective counterparty of the total return swap. The counterparty has to comply with the general requirements of the Strategy Manager for counterparty selection, including the best execution criteria of Strategy Manager, and is not a related party to the Strategy Manager. The counterparty assumes no discretion over the composition or management of the respective asset classes.

3) Investment Restrictions

- Min. 70% of Sub-Fund assets are invested in Debt Securities and/or Equities and/or other asset classes in accordance with the Sub-Fund's investment objective by using a gross calculation exposure approach (long exposure plus short exposure)
- Sub-Fund assets may be invested in Emerging Markets
- Sub-Fund assets (excluding ABS/MBS) may be invested in High-Yield Investments Type 2
- Max. 10% of Sub-Fund assets may be invested into the China A-Shares market
- Sub-Fund assets may be invested in securities referring to
 1. Equities
 2. Debt Securities
 3. UCITS and/or UCI
 4. indices (including bond, equity (including assets of companies operating in the private equity sector), hedge funds indices and indices that refer to companies active in private equity); securities referring to indices other than financial indices are only to be acquired if they are geared towards a 1:1 replication of the underlying index/indices
 5. currencies
 6. currency forward and/or future contracts
 7. real estate property funds
 8. baskets of the aforementioned underlying assets and/or
 9. commodities.
- Securities referring to an underlying asset as defined in No. 5 to 7 may only be acquired and/or if they are geared towards a 1:1 replication of the respective underlying asset. This applies accordingly to securities as defined in No. 8, insofar as they have underlying assets as defined in No. 5 to 7. Securities with an underlying asset as defined in No. 5 to 7 may not provide for any mandatory physical delivery or grant the issuer the right to make physical delivery of the relevant underlying asset. This applies accordingly to securities as defined in No. 8, insofar as they have underlying assets as defined in No. 5 to 7.
- Duration: not restricted
- GITA Restriction (Alternative 1) applies
- Benchmark: MSCI World Total Return Net. Degree of Freedom: material. Expected Overlap: major

Allianz Dynamic Commodities

Investment Objective

Risk adjusted returns through all market cycles by investing in the international equity, commodity and bond markets while participating in the performance of the Dynamic Commodities Strategy.

Investment Restrictions

1) Description of the Dynamic Commodities Strategy (the "Strategy")

The Strategy will be managed by AllianzGI (the "Strategy Manager"). The Strategy will focus on exchange traded certificates ("ETC") which replicate the exposure to single commodities. The ETC complement the investment into Total Return Swaps on broadly diversified financial indices, in the meaning of Article 9 of the Grand-ducal regulation of 8 February 2008, on the commodities market. Further information with regard to Total Return Swaps is disclosed in Appendix 7. Only such ETC will be used which comply with Article 2 of the Grand-ducal regulation of 8 February 2008. The target weight of each single commodity is the sum of the commodity weight within the index and the weight of the same commodity within the ETC.

The Investment Manager acting as manager of the Strategy invests in standard commodity market indices and ETC to provide exposure to single commodities (each a "Commodity" and together "Commodities") each of which can be categorized into one of the three commodity sectors Energy, Industrial Metals and Precious Metals ("Commodity Sectors").

The Strategy is mainly based on a quantitative model that determines the weighting of these Commodities using a dynamic allocation mechanism, which uses fundamental and technical data.

The Strategy tries to capture market trends and best performing Commodities over time based on analysis of historical performance of the Commodities and computes signals and factors to adjust the Commodity exposure, for example to the state of the business cycle based on a fixed set of Commodity related economic indicators.

The maximum weight of each Commodity within the Strategy is limited to 20% of the Strategy notwithstanding the possibility of one Commodity exceeding 20% of the Strategy up to 35 % of the Strategy. If two or several Commodities within a Commodity Sector are highly correlated, the cumulative weight of these Commodities should not exceed the limits as defined in the previous sentence.

The maximum weights of each single Commodity Sector are limited to:

- Energy: 60%
- Industrial Metals: 50%
- Precious Metals: 40%

The overall diversified exposure to the Strategy will be in a bandwidth of 0% to max. 150% of the value of Sub-Fund assets. The reallocation of the Strategy is performed frequently on a weekly basis. In case of extreme market conditions discretionary intra-week adjustments to the allocation process of the Strategy can be performed.

2) Implementation of the Strategy ("Transfer of Strategy's performance" as described under letter a) of asset class description)

3) Investment Restrictions

- Sub-Fund assets may be invested in Emerging Markets
- Sub-Fund assets may not be invested in ABS and/or MBS
- Max. 10% of Sub-Fund assets may be invested in High-Yield Investments Type 2
- Duration: below 36 months
- VAG Investment Restriction applies
- Benchmark: BLOOMBERG Commodity Excl. Agriculture Excl. Livestock Capped Total Return (Shifted By 2 Days Forward) (hedged into EUR) (valid until 30 September 2023) / BLOOMBERG Commodity Excl. Agriculture Excl. Livestock Capped Total Return (Shifted By 2 Days Forward) (valid as of 1 October 2023). Degree of Freedom: material. Expected Overlap: minor

Allianz Fixed Income Macro

Investment Objective

The Sub-Fund seeks to generate superior risk adjusted returns over any rolling three-year period. The investment policy is geared towards generating appropriate annualised returns by investing in global government Debt Securities and/or global Equities by taking into account the opportunities and risks of a strategy in long and short positions in the global Bond and Equity Markets.

Investment Restrictions

1) Description of the Investment Manager's Strategy

The Sub-Fund invests in the following asset classes: Interest Rates, Currencies, Inflation and Credit. Within these areas, the fund will be wholly unconstrained in terms of product and region.

A. Rates

This strategy assesses the drivers of interest rates and their direction along the curve. The Sub-Fund would make use of a range of instruments, including but not limited to, cash bonds, bond futures, interest rate swaps, bond future options, interest rate futures, and options on interest rate futures in implementing positions here.

B. Credit

The Investment Manager's credit strategy assesses the outlook for risky assets, credit spreads and volatility. The Sub-Fund may build positions using instruments such as cash bonds and credit default swaps, to take positions at the individual issuer or at the index level.

C. Inflation

Inflation strategies are used to generate outperformance from taking a view on inflation. This involves using derivatives such as inflation-swaps or through investing in inflation-linked bonds.

D. Currencies

FX markets can reflect macroeconomic factors which are sometimes not reflected in bond markets. The Sub-Fund will trade currencies via spot and forward FX strategies but will place particular emphasis on option and volatility strategies.

Typically, the Sub-Fund will use derivatives in a range of asset classes, as above. As a result of its use of derivatives, the Sub-Fund may be required to hold a large amount of cash and short maturity bonds. The Sub-Fund has a very flexible investment approach, and the managers will allocate into the different investment strategies depending on the opportunities present in the market. The Sub-Fund's investment manager may invest in options and/or future-contracts on equity indices (equity index options / equity index futures) for investment purposes, efficient portfolio management and hedging purposes. Sub-Fund's investment manager will typically invest in 5-15 individual strategies within its range of asset classes.

2) Implementation of the Strategy ("Direct Implementation of Strategy" as described under letter b) of asset class description)

The Sub-Fund uses the overall framework of a Long / Short Approach ("Strategy"). The Strategy's gross exposure (long positions plus short positions) can be up to 35 times the Sub-Fund's Net Asset Value (NAV). Sub-Fund assets are invested in derivatives (i) to hedge a currency exposure and/or to take an investment position using a derivative as a substitute for taking a position in the underlying asset where Sub-Fund's Investment Manager believes that a derivative exposure to the underlying asset represents better value than direct (physical) exposure (ii) to tailor the Sub-Fund's interest rate exposure to the Investment Manager's discretionary outlook for interest rates (iii) to tailor the Sub-Fund's inflation rate exposure to the Investment Manager's discretionary outlook for inflation rates (iv) to tailor the Sub-Fund's credit risk exposure to the Investment Manager's discretionary outlook for credit spreads and defaults (v) to gain an exposure to the composition and performance of a particular index. Sub-Fund's Investment Manager may invest using an unconstrained approach to

allocate up to 100% of Sub-Fund assets to Debt Securities including global sovereign bonds which includes agencies and municipalities, global credit including high yield and global foreign exchange currencies. Investments in either derivatives or Debt Securities may be made anywhere in the world including developed markets and non-developed markets or Emerging Market countries.

Sub-Fund's Investment Manager may primarily construct its portfolio using derivatives in order to express investment views. This means that the leverage of the Sub-Fund will on average be very high over the investment cycle. Sub-Fund's Investment Manager will make extensive use of derivatives for investment purposes and for efficient portfolio management (including for hedging).

3) Investment Restrictions

- Min. 70% of Sub-Fund assets are invested in Debt Securities and/or Equities and/or other asset classes in accordance with the Sub-Fund's investment objective by using a gross calculation exposure approach (long exposure plus short exposure)
- Sub-Fund assets may be invested in Emerging Markets
- Max. 30% of Sub-Fund assets may be invested in the PRC Bond Markets
- Benchmark: SONIA. Degree of Freedom: significant. Expected Overlap: not applicable

Allianz Multi Asset Long / Short

Investment Objective

The investment policy aims to generate long term capital growth through investments in a broad range of asset classes. The Sub-Fund seeks to generate superior risk adjusted returns throughout a market cycle. The investment policy is geared towards generating appropriate annualized returns while taking into account the opportunities and risks of a Long / Short multi asset strategy.

Investment Restrictions

1) Description of the Investment Manager's strategy

The Investment Manager allocates the Sub-Fund assets to different asset classes (e.g., Equities, REITs, commodities, sovereign bonds, covered bonds, inflation-linked bonds, high yield bonds, Emerging Markets bonds, various currencies) by investing in certain assets ("Long Positions"), while selling certain assets ("Short Positions"), together the "Multi Asset Long/Short Approach". The Multi Asset Long/Short Approach only considers such asset classes for which the respective exposure can be generated by acquiring assets or using techniques and instruments which are deemed to be sufficiently liquid, in order to target at daily liquidity of the Sub-Fund. The Investment Manager may also assume separate currency positions, corresponding derivatives, and foreign currencies, even if the Sub-Fund does not include any assets denominated in these respective currencies. The Multi Asset Long/Short Approach aims to generate a leveraged risk exposure through the use of derivatives in comparison to a portfolio which would allocate each asset class by the acquisition of assets without the use of derivatives.

2) Implementation of the Strategy ("Direct Implementation of Strategy" as described under letter b) of asset class description)

The Investment Manager has full discretion as to how to generate positive (Long Positions) as well as negative exposure (Short positions) of the respective asset classes. The Strategy's gross exposure (long positions plus short positions) can be up to 5 times the Sub-Fund's Net Asset Value (NAV). Such Exposure - Long Positions and/or Short Positions - can be generated by either acquiring or selling assets or by using derivatives. Such derivatives may include, but is not limited to, the use of futures, forward contracts, options, and swaps such as total return swaps and, credit default swaps. If total return swaps are used the respective counterparty assumes no discretion over the respective underlying of the total return swap. Further information is disclosed in Appendix 7. The Investment Manager may use total return swaps to generate positive or negative exposure to the respective asset classes. By using total return swaps, the Investment Manager exchanges a regular variable payment from the Sub-Fund against a participation in the positive or negative performance of the respective asset classes. This performance may also be negative, which would then result in an additional payment from the Sub-Fund to the respective counterparty of the total return swap. The counterparty has to comply with the general requirements of the Investment Manager for counterparty selection, including the best execution criteria of the Investment Manager, and is not a related party to the Investment Manager. The counterparty assumes no discretion over the composition or management of the respective asset classes.

3) Investment Restrictions

- Min. 70% of Sub-Fund assets are invested in Debt Securities and/or Equities and/or other asset classes in accordance with the Sub-Fund's investment objective by using a gross calculation exposure approach (long exposure plus short exposure)
- Sub-Fund assets may be invested in Emerging Markets
- Sub-Fund assets (excluding ABS/MBS) may be invested in High-Yield Investments Type 2
- Sub-Fund assets may be invested in securities referring to
 1. Equities
 2. Debt Securities
 3. UCITS and/or UCI
 4. indices (including bond, equity (including assets of companies operating in the private equity sector), hedge funds indices and indices on commodity futures, precious metal or commodities as well as indices that refer to companies active in the area of private equity); securities referring to indices other than financial indices are only to be acquired if they are geared towards a 1:1 replication of the underlying index/indices
 5. commodities
 6. commodity forward and/or future contracts
 7. currencies
 8. currency forward and/or future contracts
 9. real estate property funds and/or
 10. baskets of the aforementioned underlying assets.
- Securities referring to an underlying asset as defined in No. 5 to 8 may only be acquired if they are geared towards a 1:1 replication of the respective underlying asset. This applies accordingly to securities as defined in No. 10, insofar as they have

underlying assets as defined in No. 5 to 8. Securities with an underlying asset as defined in No. 5 to 9 may not provide for any mandatory physical delivery or grant the issuer the right to make physical delivery of the relevant underlying asset. This applies accordingly to securities as defined in No. 10, insofar as they have underlying assets as defined in No. 5 to 9.

- Up to 40% of the Sub-Fund assets may be invested in securities referring to commodities and/or commodity forwards and/or commodity futures as well as in techniques and instruments referring to commodity indices. Taking the overall framework of a Multi Asset Long / Short Approach into consideration the 40% are allowed to be Long Positions and/or Short Positions such the net market exposure of the aforementioned assets is expected to be in a maximum range of +40% and- 40% of the Net Asset Value of the Sub-Fund.
- Duration: not restricted
- VAG Investment Restriction applies
- Benchmark: SECURED OVERNIGHT FINANCING RATE (SOFR). Degree of Freedom: significant. Expected Overlap: not applicable

Allianz Multi Asset Opportunities

Investment Objective

The investment policy aims to generate long term capital growth through investments in a broad range of asset classes. The Sub-Fund seeks to generate superior risk adjusted returns throughout a market cycle. The investment policy is geared towards generating appropriate annualized returns while taking into account the opportunities and risks of a highly flexible multi asset strategy.

Investment Restrictions

1) Description of the Investment Manager's strategy

The Investment Manager allocates the Sub-Fund assets to different asset classes (e.g., Equities, REITs, commodities, sovereign bonds, covered bonds, inflation-linked bonds, high yield bonds, Emerging Markets bonds, various currencies). The Investment Manager only considers such asset classes for which the respective exposure can be generated by acquiring assets or using techniques and instruments which are deemed to be sufficiently liquid, in order to target at daily liquidity of the Sub-Fund. The Investment Manager may also assume separate currency positions, corresponding derivatives and foreign currencies, even if the Sub-Fund does not include any assets denominated in these respective currencies. The Investment Manager has full discretion as to how to generate exposure of the respective asset classes. Such Exposure can be generated by either acquiring assets or by using derivatives. Such derivatives may include, but is not limited to, the use of futures, forward contracts, options and swaps such as total return swaps and, credit default swaps. If total return swaps are used the respective counterparty assumes no discretion over the respective underlying of the total return swap. Further information is disclosed in Appendix 7.

2) Implementation of the Strategy ("Direct Implementation of Strategy" as described under letter b) of asset class description)

By using total return swaps, the Investment Manager exchanges a regular variable payment from the Sub-Fund against a participation in the performance of the respective asset classes. This performance may also be negative, which would then result in an additional payment from the Sub-Fund to the respective counterparty of the total return swap. The counterparty has to comply with the general requirements of the Investment Manager for counterparty selection, including the best execution criteria of the Investment Manager, and is not a related party to the Investment Manager. The counterparty assumes no discretion over the composition or management of the respective asset classes.

3) Investment Restrictions

- Sub-Fund assets may be invested in Emerging Markets
- Sub-Fund assets may be invested in High-Yield Investments Type 1
- Sub-Fund assets may be invested in securities referring to
 1. Equities
 2. Debt Securities
 3. UCITS and/or UCI
 4. indices (including bond, equity (including assets of companies operating in the private equity sector), hedge funds indices and indices on commodity futures, precious metal or commodities as well as indices that refer to companies active in the area of private equity); securities referring to indices other than financial indices are only to be acquired if they are geared towards a 1:1 replication of the underlying index/indices
 5. commodities
 6. commodity forward and/or future contracts
 7. currencies
 8. currency forward and/or future contracts
 9. real estate property funds and/or
 10. baskets of the aforementioned underlying assets.
- Securities referring to an underlying asset as defined in No. 5 to 8 may only be acquired if they are geared towards a 1:1 replication of the respective underlying asset. This applies accordingly to securities as defined in No. 10, insofar as they have underlying assets as defined in in No. 5 to 8. Securities with an underlying asset as defined in No. 5 to 9 may not provide for any mandatory physical delivery or grant the issuer the right to make physical delivery of the relevant underlying asset. This applies accordingly to securities as defined in No. 10, insofar as they have underlying assets as defined in No. 5 to 9.
- Max 40% of the Sub-Fund assets may be invested in securities referring to commodities and/or commodity forwards and/or commodity futures as well as in techniques and instruments referring to commodity indices.
- Duration: not restricted
- VAG Investment Restriction applies
- Benchmark: SECURED OVERNIGHT FINANCING RATE (SOFR). Degree of Freedom: significant. Expected Overlap: not applicable

Allianz Multi Asset Risk Premia

Investment Objective

The investment policy aims to generate long term capital growth by capturing various market risk premia such as carry (a carry strategy goes long assets that offer a high current income and short those with low current income), momentum (a momentum strategy goes long assets with a relatively positive past performance and short the ones with a relatively negative past performance), and value (a value strategy goes long the cheaply valued assets and short the expensive) assets across major asset classes (Equity, Debt Securities, currencies, and commodities).

Investment Restrictions

- 1) Description of the Investment Manager's strategy
The portfolio management team aims to provide investors with a core solution to access a diversified set of alternative risk premia, through levered long and short exposures in a wide range of asset classes. The investment strategy seeks to achieve attractive risk-adjusted returns and can increase overall portfolio diversification through low correlation to traditional asset classes.
- 2) Implementation of the Strategy ("Direct Implementation of Strategy" as described under letter b) of asset class description)
The Investment Manager has full discretion as to how to generate positive (Long Positions) as well as negative exposure (Short positions) of the respective asset classes. The Strategy's gross exposure (long positions plus short positions) can be up to 18 times the Sub-Fund's Net Asset Value (NAV). Such Exposure - Long Positions and/or Short Positions - can be generated by either acquiring or selling assets or by using derivatives. Such derivatives may include, but is not limited to, the use of futures, forward contracts, options, and swaps such as total return swaps, and credit default swaps. If total return swaps are used the respective counterparty assumes no discretion over the respective underlying of the total return swap. Further information is disclosed in Appendix 7. The Investment Manager may use total return swaps to generate positive or negative exposure to the respective asset classes. By using total return swaps, the Investment Manager exchanges a regular variable payment from the Sub-Fund against a participation in the positive or negative performance of the respective asset classes. This performance may also be negative, which would then result in an additional payment from the Sub-Fund to the respective counterparty of the total return swap. The counterparty has to comply with the general requirements of the Investment Manager for counterparty selection, including the best execution criteria of the Investment Manager, and is not a related party to the Investment Manager. The counterparty assumes no discretion over the composition or management of the respective asset classes.
- 3) Investment Restrictions
 - Min. 70% of Sub-Fund assets are invested in Debt Securities and/or Equities and/or other asset classes in accordance with the Sub-Fund's investment objective by using a gross calculation exposure approach (long exposure plus short exposure)
 - Sub-Fund assets may be invested in Emerging Markets
 - Sub-Fund assets may be invested in High-Yield Investments Type 1
 - Sub-Fund assets may be invested in securities referring to
 1. Equities
 2. Debt Securities
 3. UCITS and/or UCI
 4. indices (including bond, equity (including assets of companies operating in the private equity sector), hedge funds indices and indices on commodity futures, precious metal or commodities as well as indices that refer to companies active in the area of private equity); securities referring to indices other than financial indices are only to be acquired if they are geared towards a 1:1 replication of the underlying index/indices
 5. Commodities
 6. commodity forward and/or future contracts
 7. currencies
 8. currency forward and/or future contracts
 9. real estate property funds and/or
 10. baskets of the aforementioned underlying assets.
 - Securities referring to an underlying asset as defined in No. 5 to 8 may only be acquired if they are geared towards a 1:1 replication of the respective underlying asset. This applies accordingly to securities as defined in No. 10, insofar as they have underlying assets as defined in in No. 5 to 8. Securities with an underlying asset as defined in No. 5 to 9 may not provide for any mandatory physical delivery or grant the issuer the right to make physical delivery of the relevant underlying asset. This applies accordingly to securities as defined in No. 10, insofar as they have underlying assets as defined in No. 5 to 9.
 - Up to 40% of the Sub-Fund assets may be invested in securities referring to commodities and/or commodity forwards and/or commodity futures as well as in techniques and instruments referring to commodity indices. Taking the overall framework of a Long / Short Approach into consideration the 40% are allowed to be Long Positions and/or Short Positions such the net market exposure of the aforementioned assets is expected to be in a maximum range of +40% and- 40% of the Net Asset Value of the Sub-Fund.
 - Duration: not restricted
 - Benchmark: SECURED OVERNIGHT FINANCING RATE (SOFR). Degree of Freedom: significant. Expected Overlap: not applicable

Allianz Strategic Bond

Investment Objective

Long term capital growth by investing in global bond markets. The investment policy is geared towards generating appropriate annualised returns above the markets based on global government and corporate bonds by taking into account the opportunities and risks of a strategy in long and short positions in the global Bond Markets.

Investment Restrictions

1) Description of the Investment Manager's Strategy

The Sub-Fund invests in the following asset classes: Interest Rates, Currencies, Inflation and Credit. Within these areas, the Sub-Fund will be wholly unconstrained in terms of product and region.

A. Rates

This strategy assesses the drivers of interest rates and their direction along the curve. The Sub-Fund would make use of a range of instruments, including but not limited to, cash bonds, bond futures, interest rate swaps, bond future options, interest rate futures, and options on interest rate futures in implementing positions here.

B. Credit

The Sub-Fund's credit strategy assesses the outlook for risky assets, credit spreads and volatility. The Sub-Fund may build positions using instruments such as cash bonds and credit default swaps, to take positions at the individual issuer or at the index level.

C. Inflation

Inflation strategies are used to generate outperformance from taking a view on inflation. This involves using derivatives such as inflation-swaps or through investing in inflation-linked bonds.

D. Currencies

FX markets can reflect macroeconomic factors which are sometimes not reflected in bond markets. The Sub-Fund will trade currencies via spot and forward FX strategies, as well as taking positions on FX options and volatility strategies.

2) Implementation of the Strategy ("Direct Implementation of Strategy" as described under letter b) of asset class description)

The Sub-Fund uses the overall framework of a Long / Short Approach. The Investment Manager has full discretion as to how to generate positive (Long Positions) as well as negative exposure (Short positions) of the respective asset classes. The Strategy's gross exposure (long positions plus short positions) is allowed to be up to 10 times the Sub-Fund's Net Asset Value (NAV). Sub-Fund assets are invested in derivatives (i) to hedge a currency exposure and/or to take an investment position using a derivative as a substitute for taking a position in the underlying asset where Sub-Fund's Investment Manager believes that a derivative exposure to the underlying asset represents better value than direct (physical) exposure (ii) to tailor the Sub-Fund's interest rate exposure to the Investment Manager's discretionary outlook for interest rates (iii) to tailor the Sub-Fund's inflation rate exposure to the Investment Manager's discretionary outlook for inflation rates (iv) to tailor the Sub-Fund's credit risk exposure to the Investment Manager's discretionary outlook for credit spreads and defaults (v) to gain an exposure to the composition and performance of a particular index. Sub-Fund's Investment Manager may invest using an unconstrained approach to allocate up to 100% of Sub-Fund assets to debt securities including global sovereign bonds which includes agencies and municipalities, global credit including high yield and global foreign exchange currencies. Investments in either derivatives or debt securities may be made anywhere in the world including developed markets and non-developed markets or emerging market countries.

Sub-Fund's Investment Manager may primarily construct its portfolio using derivatives in order to express investment views. This means that the leverage of the Sub-Fund will on average be very high over the investment cycle. Sub-Fund's Investment Manager will make extensive use of derivatives for investment purposes and for efficient portfolio management (including for hedging).

3) Investment Restrictions

- Min. 70% of Sub-Fund assets are invested in Debt Securities in accordance with the Sub-Fund's investment objective by using a gross calculation exposure approach (long exposure plus short exposure)
- Sub-Fund assets are primarily invested in Debt Securities (including derivatives) as described in the investment objective
- Sub-Fund assets may be invested in Emerging Markets
- Max. 50% of Sub-Fund assets (excluding ABS/MBS) may be invested in High-Yield Investments Type 1
- Max. 30% of Sub-Fund assets may be invested in the PRC bond markets
- Benchmark: BLOOMBERG Global Aggregate Total Return (hedged into USD). Degree of Freedom: significant. Expected Overlap: major

Allianz Unconstrained Multi Asset Strategy

Investment Objective

The Sub-Fund seeks to generate superior risk adjusted returns throughout a market cycle. The investment policy is geared towards generating appropriate annualized returns through investments in a broad range of asset classes.

Investment Restrictions

1) Description of the Investment Manager's strategy

Sub-Fund's investment manager allocates the Sub-Fund assets to different asset classes (e.g., Equities, REITs, commodities, sovereign bonds, covered bonds, inflation-linked bonds, high yield bonds, Emerging Markets bonds, various currencies). The investment manager may also invest in certain assets ("Long Positions"), while selling certain assets ("Short Positions"). The strategy of the Sub-Fund only considers such asset classes for which the respective exposure can be generated by acquiring assets or using techniques and instruments which are deemed to be sufficiently liquid, in order to target at daily liquidity of the Sub-Fund. The investment manager may also assume separate currency positions, corresponding derivatives and foreign currencies, even if the Sub-Fund does not include any assets denominated in these respective currencies. The strategy of the Sub-Fund aims to generate a leveraged risk exposure through the use of derivatives in comparison to a portfolio which would allocate each asset class by the acquisition of assets without the use of derivatives.

2) Implementation of the Strategy ("Direct Implementation of Strategy" as described under letter b) of asset class description)

The Investment Manager has full discretion as to how to generate positive (Long Positions) as well as negative exposure (Short positions) of the respective asset classes. The Strategy's gross exposure (long positions plus short positions) can be up to 7 times the Sub-Fund's Net Asset Value (NAV). The Investment Manager may use different forms of techniques and instruments implementing the Sub-Fund's strategy. When using total return swaps, the Investment Manager exchanges a regular variable payment from the Sub-Fund against a participation in the performance of the respective asset classes. This performance may also be negative, which would then result in an additional payment from the Sub-Fund to the respective counterparty of the total return swap. The counterparty has to comply with the general requirements of the investment manager for counterparty selection, including the best execution criteria of the Investment Manager, and is not a related party to the Investment Manager. The counterparty assumes no discretion over the composition or management of the respective asset classes. Further information with regard to Total Return Swaps is disclosed in Appendix 7.

3) Investment Restrictions

- Min. 70% of Sub-Fund assets are invested in Debt Securities and/or Equities and/or other asset classes in accordance with the Sub-Fund's investment objective by using a gross calculation exposure approach (long exposure plus short exposure)
- Sub-Fund assets may be invested in Emerging Markets
- Sub-Fund assets may be invested in High-Yield Investments Type 2
- Sub-Fund assets may be invested in securities referring to
 1. Equities
 2. Debt Securities
 3. UCITS and/or UCI
 4. Indices (including bond, equity (including assets of companies operating in the private equity sector), hedge funds indices and indices on commodity futures, precious metal, or commodities as well as indices that refer to companies active in private equity); securities referring to indices other than financial indices are only to be acquired if they are geared towards a 1:1 replication of the underlying index/indices
 5. Commodities
 6. Commodity forward and/or future contracts
 7. Currencies
 8. Currency forward and/or future contracts
 9. Real estate property funds and/or
 10. Baskets of the aforementioned underlying assets.
- Securities referring to an underlying asset as defined in No. 5 to 8 may only be acquired if they are geared towards a 1:1 replication of the respective underlying asset. This applies accordingly to securities as defined in No. 10, insofar as they have underlying assets as defined in No. 5 to 8. Securities with an underlying asset as defined in No. 5 to 9 may not provide for any mandatory physical delivery or grant the issuer the right to make physical delivery of the relevant underlying asset. This applies accordingly to securities as defined in No. 10, insofar as they have underlying assets as defined in No. 5 to 9.
- Max 40% of Sub-Fund assets may be invested in securities referring to commodities and/or commodity forwards and/or commodity futures as well as in techniques and instruments referring to commodity indices.
- Max. 30% of Sub-Fund assets may be invested into China A-Shares market
- Max. 10% of Sub-Fund assets may be invested in the PRC bond markets
- Duration: not restricted
- VAG Investment Restriction applies
- Benchmark: EURO SHORT-TERM RATE (€STR). Degree of Freedom: significant. Expected Overlap: not applicable

Allianz Volatility Strategy Fund

Investment Objective

Long-term capital growth by exploiting return opportunities in the volatility space based on the volatility risk premium through investments in a broad range of asset classes. In addition, the Sub-Fund will use volatility related derivatives including, but not limited to, variance swaps, options and volatility swaps related to different asset classes. The Sub-Fund's core strategy uses variance swaps on Equity Markets of the US and Europe as underlying.

Investment Restrictions

1) Description of the Volatility Strategy (the "Strategy")

Sub-Fund's portfolio management may use different variance swaps, generally capped, running in parallel for the purpose of harvesting volatility premium. These swaps may differ in terms of swap period, underlying security, and strike variance. A variance swap results in a financial settlement between the parties at the end of the swap period. The value of a variance swap does not depend 1:1 on the absolute performance of the underlying to which it refers; instead, it depends in particular on the change in the annualised realised variance of the respective underlying in the respective swap period. For this reason, the value of a variance swap may even rise when the value of its underlying is dropping, or it may fall when the value of its underlying security is rising. The success of the portfolio management's investment strategy therefore depends particularly on the extent to which, within the quantitative approach, the change in the annualised realised variance of the respective underlying can be accurately forecast for a corresponding swap period. In addition, the Sub-Fund's portfolio management may use additional instruments and techniques to a limited extent which include, but are not limited to options/futures on equity indices, and/or other volatility based derivatives, for efficient portfolio management.

2) Implementation of the Strategy ("Direct Implementation of Strategy" as described under letter b) of asset class description)

3) Investment Restrictions

- Sub-Fund assets may be invested in Emerging Markets
- Sub-Fund assets are invested in investment grade rated Debt Securities of OECD, EEA and/or EU member states
- Up to 10% of Sub-Fund assets may be invested in UCITS and/or UCI which are Money-market funds, and which invest in Money Market instruments with Investment Grade
- Sub-Fund assets are invested in volatility related derivatives, including but not limited to variance swaps, on global Equity Markets
- Duration: between 0 and 24 months
- VAG Investment Restriction applies
- Benchmark: EURO SHORT-TERM RATE (€STR). Degree of Freedom: significant. Expected Overlap: not applicable

Appendix 2 Fees and Expenses

Part A

The following notes apply to all Sub-Funds:

- The column "Share Class" includes all Shares within all respective Share Classes. Indications are made within this column when exceptions apply.
- The Management Company has discretion to levy lower fees and expenses.
- The Conversion Fee refers to a conversion into the mentioned Share Class of a Sub-Fund.
- Share Classes C/CT may include a separate distribution component for additional services of the Distributor(s).
- Share Classes B/BT will not be subject to a Sales Charge but will be subject to the CDSC (if applicable) and an additional servicing charge which will result in a higher All-in-Fee to be calculated and accrued daily by reference to the Net Asset Value per Share of such Shares and paid monthly to the Management Company or such other party as the Management Company may appoint from time to time.
- A CDSC will be deducted on any Shares redeemed within three years of purchase, as follows:
 - First year 3.00%
 - Second year 2.00%
 - Third year 1.00%
 - Thereafter 0%

The applicable rate of CDSC is determined by reference to the total length of time during which the Shares being redeemed. Shares will be redeemed on a first in, first out ("FIFO") basis, so that the Share Classes B/BT first being redeemed are those Shares of the Sub-Fund which have been held for the longest period. The amount of CDSC is calculated by multiplying the relevant percentage rate as determined above by the lower of a) the Net Asset Value per Share of the Shares being redeemed on the relevant Dealing Day or b) the cost paid for the original issue of Shares being redeemed or for the B/BT Shares of another Sub-Fund from which those Shares were switched, in either case calculated in the relevant dealing currency of the Shares being redeemed.

- For Share Classes X/XT an All-in-Fee will be applied unless another fee, which may include a performance-related component, is agreed based on a special individual agreement between the Management Company and the respective investor.
- Details of the modalities of Placement Fees, Redemption Fees, Disinvestment Fees and/or Exit Fees as well as specific minimum subscription amounts per Sub-Fund and/or Share Class are set out in Appendix 6

Sub-Fund Name	Share Class	Sales Charge	Placement Fee	Conversion Fee	Redemption Fee	Disinvestment Fee	Exit Fee	CDSC	All-in-Fee (p.a.)	Taxe d' Abonnement (p.a.)
Allianz ActiveInvest Balanced	A/AT	5.00 %	-	5.00 %	-	-	-	-	1.50 %	0.05 %
	C/CT	-	-	-	-	-	-	-	2.50 %	0.05 %
	I/IT	-	-	-	-	-	-	-	0.80 %	0.01 %
	N/NT	-	-	-	-	-	-	-	0.70 %	0.05 %
	P/PT	2.00 %	-	2.00 %	-	-	-	-	0.80 %	0.05 %
	R/RT	-	-	-	-	-	-	-	0.90 %	0.05 %
	S/ST	7.00 %	-	7.00 %	-	-	-	-	0.90 %	0.05 %
	W/WT	-	-	-	-	-	-	-	0.70 %	0.01 %
	X/XT	-	-	-	-	-	-	-	0.60 %	0.01 %
	Y/YT	-	-	-	-	-	-	-	0.80 %	0.05 %

- Allianz Global Investors Fund -

Sub-Fund Name	Share Class	Sales Charge	Placement Fee	Conversion Fee	Redemption Fee	Disinvestment Fee	Exit Fee	CDSC	All-in-Fee (p.a.)	Taxe d' Abonnement (p.a.)
Allianz ActiveInvest Defensive	A/AT	5.00 %	-	5.00 %	-	-	-	-	1.50 %	0.05 %
	C/CT	-	-	-	-	-	-	-	2.50 %	0.05 %
	I/IT	-	-	-	-	-	-	-	0.80 %	0.01 %
	N/NT	-	-	-	-	-	-	-	0.70 %	0.05 %
	P/PT	2.00 %	-	2.00 %	-	-	-	-	0.80 %	0.05 %
	R/RT	-	-	-	-	-	-	-	0.90 %	0.05 %
	S/ST	7.00 %	-	7.00 %	-	-	-	-	0.90 %	0.05 %
	W/WT	-	-	-	-	-	-	-	0.70 %	0.01 %
	X/XT	-	-	-	-	-	-	-	0.60 %	0.01 %
Y/YT	-	-	-	-	-	-	-	0.80 %	0.05 %	
Allianz ActiveInvest Dynamic	A/AT	5.00 %	-	5.00 %	-	-	-	-	1.50 %	0.05 %
	C/CT	-	-	-	-	-	-	-	2.50 %	0.05 %
	I/IT	-	-	-	-	-	-	-	0.80 %	0.01 %
	N/NT	-	-	-	-	-	-	-	0.70 %	0.05 %
	P/PT	2.00 %	-	2.00 %	-	-	-	-	0.80 %	0.05 %
	R/RT	-	-	-	-	-	-	-	0.90 %	0.05 %
	S/ST	7.00 %	-	7.00 %	-	-	-	-	0.90 %	0.05 %
	W/WT	-	-	-	-	-	-	-	0.70 %	0.01 %
	X/XT	-	-	-	-	-	-	-	0.60 %	0.01 %
Y/YT	-	-	-	-	-	-	-	0.80 %	0.05 %	
Allianz Advanced Fixed Income Euro	A/AT	3.00 %	-	3.00 %	-	-	-	-	1.50 %	0.05 %
	C/CT	3.00 %	-	3.00 %	-	-	-	-	2.25 %	0.05 %
	I/IT	2.00 %	-	2.00 %	-	-	-	-	0.46 %	0.01 %
	N/NT	-	-	-	-	-	-	-	1.05 %	0.05 %
	P/PT	2.00 %	-	2.00 %	-	-	-	-	1.05 %	0.05 %
	R/RT	-	-	-	-	-	-	-	1.30 %	0.05 %
	S/ST	7.00 %	-	7.00 %	-	-	-	-	1.50 %	0.05 %
	W/WT	-	-	-	-	-	-	-	0.31 %	0.01 %
	X/XT	-	-	-	-	-	-	-	1.05 %	0.01 %
Y/YT	-	-	-	-	-	-	-	0.46 %	0.05 %	
Allianz Advanced Fixed Income Global	A/AT	5.00 %	-	5.00 %	-	-	-	-	1.20 %	0.05 %
	C/CT	5.00 %	-	5.00 %	-	-	-	-	1.95 %	0.05 %
	F/FT	-	-	-	-	-	-	-	0.40 %	0.01 %
	I/IT	2.00 %	-	2.00 %	-	-	-	-	1.10 %	0.01 %
	N/NT	-	-	-	-	-	-	-	1.10 %	0.05 %
	P/PT	2.00 %	-	2.00 %	-	-	-	-	1.10 %	0.05 %
	R/RT	-	-	-	-	-	-	-	1.15 %	0.05 %
	S/ST	7.00 %	-	7.00 %	-	-	-	-	1.10 %	0.05 %
	W/WT	-	-	-	-	-	-	-	1.10 %	0.01 %
X/XT	-	-	-	-	-	-	-	1.10 %	0.01 %	
Y/YT	-	-	-	-	-	-	-	1.10 %	0.05 %	
Allianz Advanced Fixed Income Global Aggregate	A/AT	5.00 %	-	5.00 %	-	-	-	-	1.20 %	0.05 %
	C/CT	5.00 %	-	5.00 %	-	-	-	-	1.95 %	0.05 %
	F/FT	-	-	-	-	-	-	-	0.40 %	0.01 %
	I/IT	2.00 %	-	2.00 %	-	-	-	-	1.10 %	0.01 %
	N/NT	-	-	-	-	-	-	-	1.10 %	0.05 %
	P/PT	2.00 %	-	2.00 %	-	-	-	-	1.10 %	0.05 %
	R/RT	-	-	-	-	-	-	-	1.30 %	0.05 %
	S/ST	7.00 %	-	7.00 %	-	-	-	-	1.10 %	0.05 %
	W/WT	-	-	-	-	-	-	-	1.10 %	0.01 %
X/XT	-	-	-	-	-	-	-	1.10 %	0.01 %	
Y/YT	-	-	-	-	-	-	-	1.10 %	0.05 %	
Allianz Advanced Fixed Income Short Duration	A/AT	5.00 %	-	5.00 %	-	-	-	-	0.75 %	0.05 %
	C/CT	5.00 %	-	5.00 %	-	-	-	-	1.50 %	0.05 %
	I/IT	2.00 %	-	2.00 %	-	-	-	-	0.60 %	0.01 %
	N/NT	-	-	-	-	-	-	-	0.60 %	0.05 %
	P/PT	2.00 %	-	2.00 %	-	-	-	-	0.60 %	0.05 %
	R/RT	-	-	-	-	-	-	-	0.60 %	0.05 %
	S/ST	6.00 %	-	6.00 %	-	-	-	-	0.71 %	0.05 %
	W/WT	-	-	-	-	-	-	-	0.36 %	0.01 %
	X/XT	-	-	-	-	-	-	-	0.60 %	0.01 %
Y/YT	-	-	-	-	-	-	-	0.60 %	0.05 %	

- Allianz Global Investors Fund -

Sub-Fund Name	Share Class	Sales Charge	Placement Fee	Conversion Fee	Redemption Fee	Disinvestment Fee	Exit Fee	CDSC	All-in-Fee (p.a.)	Taxe d' Abonnement (p.a.)
Allianz All China Equity	A/AT	5.00 %	-	5.00 %	-	-	-	-	2.25 %	0.05 %
	C/CT	5.00 %	-	5.00 %	-	-	-	-	3.00 %	0.05 %
	E/ET	-	-	-	-	-	-	-	1.65 %	0.05 %
	I/IT	2.00 %	-	2.00 %	-	-	-	-	1.28 %	0.01 %
	N/NT	-	-	-	-	-	-	-	1.28 %	0.05 %
	P/PT	2.00 %	-	2.00 %	-	-	-	-	1.28 %	0.05 %
	R/RT	-	-	-	-	-	-	-	1.40 %	0.05 %
	S/ST	2.00 %	-	2.00 %	-	-	-	-	1.28 %	0.05 %
	W/WT	-	-	-	-	-	-	-	1.00 %	0.01 %
	X/XT	-	-	-	-	-	-	-	1.28 %	0.01 %
Y/YT	-	-	-	-	-	-	-	1.12 %	0.05 %	
Allianz Alternative Investment Strategies	A/AT	5.00 %	-	5.00 %	-	-	-	-	1.55 %	0.05 %
	C/CT	5.00 %	-	5.00 %	-	-	-	-	2.30 %	0.05 %
	I/IT	2.00 %	-	2.00 %	-	-	-	-	0.69 %	0.01 %
	I3/IT3	2.00 %	-	2.00 %	-	-	-	-	0.99 %	0.01 %
	N/NT	-	-	-	-	-	-	-	0.79 %	0.05 %
	P/PT	2.00 %	-	2.00 %	-	-	-	-	0.69 %	0.05 %
	P3/PT3	2.00 %	-	2.00 %	-	-	-	-	0.99 %	0.05 %
	R/RT	-	-	-	-	-	-	-	1.05 %	0.05 %
	R3/RT3	-	-	-	-	-	-	-	1.05 %	0.05 %
	S/ST	7.00 %	-	7.00 %	-	-	-	-	1.05 %	0.05 %
W/WT	-	-	-	-	-	-	-	0.79 %	0.01 %	
X/XT	-	-	-	-	-	-	-	0.69 %	0.01 %	
Y/YT	-	-	-	-	-	-	-	0.69 %	0.05 %	
Allianz American Income	A/AT	5.00 %	-	5.00 %	-	-	-	-	1.50 %	0.05 %
	B/BT	-	-	5.00 %	-	-	-	3.00 %	2.50 %	0.05 %
	C/CT	5.00 %	-	5.00 %	-	-	-	-	2.00 %	0.05 %
	I/IT	2.00 %	-	2.00 %	-	-	-	-	0.75 %	0.01 %
	N/NT	-	-	-	-	-	-	-	1.00 %	0.05 %
	P/PT	2.00 %	-	2.00 %	-	-	-	-	0.75 %	0.05 %
	R/RT	-	-	-	-	-	-	-	1.30 %	0.05 %
	S/ST	7.00 %	-	7.00 %	-	-	-	-	1.00 %	0.05 %
	W/WT	-	-	-	-	-	-	-	0.60 %	0.01 %
	X/XT	-	-	-	-	-	-	-	1.00 %	0.01 %
Y/YT	-	-	-	-	-	-	-	0.75 %	0.05 %	
Allianz Asian Multi Income Plus	A/AT	5.00 %	-	5.00 %	-	-	-	-	1.50 %	0.05 %
	B/BT	-	-	5.00 %	-	-	-	3.00 %	2.50 %	0.05 %
	C/CT	5.00 %	-	5.00 %	-	-	-	-	2.25 %	0.05 %
	I/IT	2.00 %	-	2.00 %	-	-	-	-	0.89 %	0.01 %
	N/NT	-	-	-	-	-	-	-	1.15 %	0.05 %
	P/PT	2.00 %	-	2.00 %	-	-	-	-	1.15 %	0.05 %
	P8/PT8/P9/PT9	2.00 %	-	2.00 %	-	-	-	-	0.95 %	0.05 %
	R/RT	-	-	-	-	-	-	-	1.30 %	0.05 %
	S/ST	7.00 %	-	7.00 %	-	-	-	-	1.38 %	0.05 %
	W/WT	-	-	-	-	-	-	-	1.15 %	0.01 %
X/XT	-	-	-	-	-	-	-	1.15 %	0.01 %	
Y/YT	-	-	-	-	-	-	-	0.89 %	0.05 %	
Allianz Asian Small Cap Equity	A/AT	5.00 %	-	5.00 %	-	-	-	-	2.05 %	0.05 %
	C/CT	5.00 %	-	5.00 %	-	-	-	-	2.80 %	0.05 %
	F/FT	-	-	-	-	-	-	-	1.75 %	0.01 %
	I/IT	2.00 %	-	2.00 %	-	-	-	-	1.75 %	0.01 %
	IT (USD)	2.00 %	-	2.00 %	-	-	-	-	1.20 %	0.01 %
	N/NT	-	-	-	-	-	-	-	1.75 %	0.05 %
	P/PT	2.00 %	-	2.00 %	-	-	-	-	1.75 %	0.05 %
	R/RT	-	-	-	-	-	-	-	1.75 %	0.05 %
	S/ST	7.00 %	-	7.00 %	-	-	-	-	1.75 %	0.05 %
	W/WT	-	-	-	-	-	-	-	1.75 %	0.01 %
	W3/WT3	-	-	-	-	-	-	-	2.05 %	0.01 %
	WT3 (USD)	-	-	-	-	-	-	-	1.95 %	0.01 %
	X/XT	-	-	-	-	-	-	-	1.75 %	0.01 %
Y/YT	-	-	-	-	-	-	-	1.20 %	0.05 %	

- Allianz Global Investors Fund -

Sub-Fund Name	Share Class	Sales Charge	Placement Fee	Conversion Fee	Redemption Fee	Disinvestment Fee	Exit Fee	CDSC	All-in-Fee (p.a.)	Taxe d' Abonnement (p.a.)
Allianz Best Ideas 2025	A/AT	4.00 %	2.00 %	4.00 %	-	-	2.00 %	-	1.50 %	0.05 %
	C/CT	4.00 %	2.00 %	4.00 %	-	-	2.00 %	-	2.25 %	0.05 %
	I/IT	2.00 %	2.00 %	2.00 %	-	-	2.00 %	-	1.00 %	0.01 %
	N/NT	-	2.00 %	-	-	-	2.00 %	-	1.00 %	0.05 %
	P/PT	2.00 %	2.00 %	2.00 %	-	-	2.00 %	-	1.00 %	0.05 %
	R/RT	-	2.00 %	-	-	-	2.00 %	-	1.00 %	0.05 %
	S/ST	7.00 %	2.00 %	7.00 %	-	-	2.00 %	-	1.00 %	0.05 %
	W/WT	-	2.00 %	-	-	-	2.00 %	-	0.80 %	0.01 %
X/XT	-	2.00 %	-	-	-	2.00 %	-	0.70 %	0.01 %	
Allianz Best of Managers	A/AT	-	2.50 %	-	-	-	2.50 %	-	1.65 %	0.05 %
	C/CT	-	2.50 %	-	-	-	2.50 %	-	2.40 %	0.05 %
	I/IT	-	2.50 %	-	-	-	2.50 %	-	1.65 %	0.01 %
	N/NT	-	2.50 %	-	-	-	2.50 %	-	1.10 %	0.05 %
	P/PT	-	2.50 %	-	-	-	2.50 %	-	1.65 %	0.05 %
	R/RT	-	2.50 %	-	-	-	2.50 %	-	1.30 %	0.05 %
	S/ST	-	2.50 %	-	-	-	2.50 %	-	1.10 %	0.05 %
	W/WT	-	2.50 %	-	-	-	2.50 %	-	1.65 %	0.01 %
	X/XT	-	2.50 %	-	-	-	2.50 %	-	1.00 %	0.01 %
	Y/YT	-	2.50 %	-	-	-	2.50 %	-	1.10 %	0.05 %
Allianz Best Styles Euroland Equity	A/AT	5.00 %	-	5.00 %	-	-	-	-	1.30 %	0.05 %
	C/CT	5.00 %	-	5.00 %	-	-	-	-	1.80 %	0.05 %
	I/IT	2.00 %	-	2.00 %	-	-	-	-	0.70 %	0.01 %
	N/NT	-	-	-	-	-	-	-	1.08 %	0.05 %
	P/PT	2.00 %	-	2.00 %	-	-	-	-	1.08 %	0.05 %
	R/RT	-	-	-	-	-	-	-	1.30 %	0.05 %
	S/ST	7.00 %	-	7.00 %	-	-	-	-	1.28 %	0.05 %
	W/WT	-	-	-	-	-	-	-	1.08 %	0.01 %
	X/XT	-	-	-	-	-	-	-	1.08 %	0.01 %
	Y/YT	-	-	-	-	-	-	-	0.70 %	0.05 %
Allianz Best Styles Europe Equity	A/AT	5.00 %	-	5.00 %	-	-	-	-	1.50 %	0.05 %
	C/CT	5.00 %	-	5.00 %	-	-	-	-	2.25 %	0.05 %
	I/IT	2.00 %	-	2.00 %	-	-	-	-	0.70 %	0.01 %
	I2/IT2	2.00 %	-	2.00 %	-	-	-	-	1.29 %	0.01 %
	N/NT	-	-	-	-	-	-	-	1.20 %	0.05 %
	P/PT	2.00 %	-	2.00 %	-	-	-	-	1.20 %	0.05 %
	R/RT	-	-	-	-	-	-	-	1.30 %	0.05 %
	S/ST	7.00 %	-	7.00 %	-	-	-	-	1.43 %	0.05 %
	W/WT	-	-	-	-	-	-	-	0.50 %	0.01 %
	X/XT	-	-	-	-	-	-	-	1.20 %	0.01 %
Y/YT	-	-	-	-	-	-	-	0.70 %	0.05 %	
Allianz Best Styles Europe Equity SRI	A/AT	5.00 %	-	5.00 %	-	-	-	-	1.60 %	0.05 %
	C/CT	5.00 %	-	5.00 %	-	-	-	-	2.25 %	0.05 %
	I/IT	2.00 %	-	2.00 %	-	-	-	-	1.00 %	0.01 %
	P/PT	2.00 %	-	2.00 %	-	-	-	-	1.20 %	0.05 %
	R/RT	-	-	-	-	-	-	-	1.30 %	0.05 %
	W/WT	-	-	-	-	-	-	-	0.80 %	0.01 %
	X/XT	-	-	-	-	-	-	-	0.80 %	0.01 %
Y/YT	-	-	-	-	-	-	-	0.80 %	0.05 %	
Allianz Best Styles Global AC Equity	A/AT	5.00 %	-	5.00 %	-	-	-	-	1.30 %	0.05 %
	C/CT	5.00 %	-	5.00 %	-	-	-	-	2.55 %	0.05 %
	I/IT	2.00 %	-	2.00 %	-	-	-	-	0.70 %	0.01 %
	N/NT	-	-	-	-	-	-	-	1.50 %	0.05 %
	P/PT	2.00 %	-	2.00 %	-	-	-	-	0.70 %	0.05 %
	P2/PT2	2.00 %	-	2.00 %	-	-	-	-	0.38 %	0.05 %
	R/RT	-	-	-	-	-	-	-	0.80 %	0.05 %
	S/ST	7.00 %	-	7.00 %	-	-	-	-	1.50 %	0.05 %
	W/WT	-	-	-	-	-	-	-	0.50 %	0.01 %
	X/XT	-	-	-	-	-	-	-	1.20 %	0.01 %
Y/YT	-	-	-	-	-	-	-	0.70 %	0.05 %	

- Allianz Global Investors Fund -

Sub-Fund Name	Share Class	Sales Charge	Placement Fee	Conversion Fee	Redemption Fee	Disinvestment Fee	Exit Fee	CDSC	All-in-Fee (p.a.)	Taxe d' Abonnement (p.a.)
Allianz Best Styles Global Equity	A/AT	5.00 %	-	5.00 %	-	-	-	-	1.30 %	0.05 %
	C/CT	5.00 %	-	5.00 %	-	-	-	-	2.25 %	0.05 %
	E/ET	5.00 %	-	5.00 %	-	-	-	-	1.30 %	0.05 %
	F/FT	-	-	-	-	-	-	-	1.20 %	0.01 %
	I/IT	2.00 %	-	2.00 %	-	-	-	-	1.20 %	0.01 %
	N/NT	-	-	-	-	-	-	-	1.20 %	0.05 %
	P/PT	2.00 %	-	2.00 %	-	-	-	-	1.20 %	0.05 %
	R/RT	-	-	-	-	-	-	-	1.30 %	0.05 %
	W/WT	-	-	-	-	-	-	-	0.50 %	0.01 %
	W8 (USD)	-	-	-	-	-	-	-	0.29 %	0.01 %
	X/XT	-	-	-	-	-	-	-	0.20 %	0.01 %
Y/YT	-	-	-	-	-	-	-	1.20 %	0.05 %	
Allianz Best Styles Global Equity SRI	A/AT	5.00 %	-	5.00 %	-	-	-	-	1.60 %	0.05 %
	C/CT	5.00 %	-	5.00 %	-	-	-	-	2.25 %	0.05 %
	E/ET	-	-	-	-	-	-	-	1.60 %	0.05 %
	I/IT	2.00 %	-	2.00 %	-	-	-	-	1.20 %	0.01 %
	P/PT	2.00 %	-	2.00 %	-	-	-	-	1.20 %	0.05 %
	R/RT	-	-	-	-	-	-	-	1.30 %	0.05 %
	W/WT	-	-	-	-	-	-	-	0.80 %	0.01 %
	X/XT	-	-	-	-	-	-	-	0.80 %	0.01 %
	Y/YT	-	-	-	-	-	-	-	0.80 %	0.05 %
	Allianz Best Styles Pacific Equity	A/AT	5.00 %	-	5.00 %	-	-	-	-	1.30 %
C/CT		5.00 %	-	5.00 %	-	-	-	-	2.55 %	0.05 %
I/IT		2.00 %	-	2.00 %	-	-	-	-	0.70 %	0.01 %
I2/IT2		2.00 %	-	2.00 %	-	-	-	-	1.41 %	0.01 %
I4/IT4		2.00 %	-	2.00 %	-	-	-	-	0.76 %	0.01 %
N/NT		-	-	-	-	-	-	-	1.40 %	0.05 %
P/PT		2.00 %	-	2.00 %	-	-	-	-	0.70 %	0.05 %
R/RT		-	-	-	-	-	-	-	0.80 %	0.05 %
S/ST		7.00 %	-	7.00 %	-	-	-	-	1.40 %	0.05 %
W/WT		-	-	-	-	-	-	-	0.50 %	0.01 %
X/XT		-	-	-	-	-	-	-	1.20 %	0.01 %
Y/YT	-	-	-	-	-	-	-	0.70 %	0.05 %	
Allianz Best Styles US Equity	A/AT	5.00 %	-	5.00 %	-	-	-	-	1.30 %	0.05 %
	C/CT	5.00 %	-	5.00 %	-	-	-	-	2.05 %	0.05 %
	F/FT	-	-	-	-	-	-	-	1.20 %	0.01 %
	I/IT	2.00 %	-	2.00 %	-	-	-	-	0.70 %	0.01 %
	I2/IT2	2.00 %	-	2.00 %	-	-	-	-	1.21 %	0.01 %
	I4/IT4	2.00 %	-	2.00 %	-	-	-	-	0.86 %	0.01 %
	N/NT	-	-	-	-	-	-	-	1.08 %	0.05 %
	P/PT	2.00 %	-	2.00 %	-	-	-	-	1.08 %	0.05 %
	R/RT	-	-	-	-	-	-	-	1.30 %	0.05 %
	W/WT	-	-	-	-	-	-	-	0.50 %	0.01 %
	X/XT	-	-	-	-	-	-	-	1.08 %	0.01 %
Y/YT	-	-	-	-	-	-	-	0.70 %	0.05 %	
Allianz Better World Defensive	A/AT	5.00 %	-	5.00 %	-	-	-	-	1.40 %	0.05 %
	C/CT	5.00 %	-	5.00 %	-	-	-	-	1.80 %	0.05 %
	C6/CT6	2.50 %	2.50 %	2.50 %	-	-	2.50 %	-	1.80 %	0.05 %
	I/IT	2.00 %	-	2.00 %	-	-	-	-	0.89 %	0.01 %
	I2/IT2	2.00 %	-	2.00 %	-	-	-	-	0.88 %	0.01 %
	N/NT	-	-	-	-	-	-	-	0.71 %	0.05 %
	P/PT	2.00 %	-	2.00 %	-	-	-	-	0.89 %	0.05 %
	R/RT	-	-	-	-	-	-	-	0.95 %	0.05 %
	S/ST	-	-	-	-	-	-	-	0.95 %	0.05 %
	W/WT	-	-	-	-	-	-	-	0.71 %	0.01 %
	W6/WT6	-	2.50 %	-	-	-	2.50 %	-	0.71 %	0.01 %
X/XT	-	-	-	-	-	-	-	0.62 %	0.01 %	
Y/YT	-	-	-	-	-	-	-	0.66 %	0.05 %	

- Allianz Global Investors Fund -

Sub-Fund Name	Share Class	Sales Charge	Placement Fee	Conversion Fee	Redemption Fee	Disinvestment Fee	Exit Fee	CDSC	All-in-Fee (p.a.)	Taxe d' Abonnement (p.a.)
Allianz Better World Dynamic	A/AT	5.00 %	-	5.00 %	-	-	-	-	2.10 %	0.05 %
	C/CT	5.00 %	-	5.00 %	-	-	-	-	2.35 %	0.05 %
	C6/CT6	2.00 %	3.00 %	2.00 %	-	-	3.00 %	-	2.35 %	0.05 %
	I/IT	2.00 %	-	2.00 %	-	-	-	-	1.12 %	0.01 %
	I2/IT2	2.00 %	-	2.00 %	-	-	-	-	0.98 %	0.01 %
	N/NT	-	-	-	-	-	-	-	0.92 %	0.05 %
	P/PT	2.00 %	-	2.00 %	-	-	-	-	1.12 %	0.05 %
	R/RT	-	-	-	-	-	-	-	1.18 %	0.05 %
	S/ST	-	-	-	-	-	-	-	1.30 %	0.05 %
	W/WT	-	-	-	-	-	-	-	0.85 %	0.01 %
	W6/WT6	-	3.00 %	-	-	-	-	3.00 %	-	0.85 %
X/XT	-	-	-	-	-	-	-	-	0.76 %	0.01 %
Y/YT	-	-	-	-	-	-	-	-	0.82 %	0.05 %
Allianz Better World Moderate	A/AT	5.00 %	-	5.00 %	-	-	-	-	1.90 %	0.05 %
	C/CT	5.00 %	-	5.00 %	-	-	-	-	2.10 %	0.05 %
	C6/CT6	2.50 %	2.50 %	2.50 %	-	-	2.50 %	-	2.10 %	0.05 %
	I/IT	2.00 %	-	2.00 %	-	-	-	-	1.04 %	0.01 %
	I2/IT2	2.00 %	-	2.00 %	-	-	-	-	0.92 %	0.01 %
	N/NT	-	-	-	-	-	-	-	0.86 %	0.05 %
	P/PT	2.00 %	-	2.00 %	-	-	-	-	1.04 %	0.05 %
	R/RT	-	-	-	-	-	-	-	1.10 %	0.05 %
	S/ST	-	-	-	-	-	-	-	1.20 %	0.05 %
	W/WT	-	-	-	-	-	-	-	0.80 %	0.01 %
	W6/WT6	-	2.50 %	-	-	-	-	2.50 %	-	0.80 %
X/XT	-	-	-	-	-	-	-	-	0.72 %	0.01 %
Y/YT	-	-	-	-	-	-	-	-	0.78 %	0.05 %
Allianz Blockchain Opportunities	A/AT	5.00 %	-	5.00 %	-	-	-	-	2.05 %	0.05 %
	C/CT	5.00 %	-	5.00 %	-	-	-	-	2.80 %	0.05 %
	I/IT	2.00 %	-	2.00 %	-	-	-	-	1.50 %	0.01 %
	N/NT	-	-	-	-	-	-	-	1.50 %	0.05 %
	P/PT	2.00 %	-	2.00 %	-	-	-	-	1.60 %	0.05 %
	R/RT	-	-	-	-	-	-	-	1.50 %	0.05 %
	S/ST	7.00 %	-	7.00 %	-	-	-	-	1.50 %	0.05 %
	W/WT	-	-	-	-	-	-	-	1.50 %	0.01 %
	X/XT	-	-	-	-	-	-	-	1.50 %	0.01 %
	Y/YT	-	-	-	-	-	-	-	1.50 %	0.05 %
Allianz Capital Plus	A/AT	3.00 %	-	3.00 %	-	-	-	-	1.15 %	0.05 %
	C/CT	3.00 %	-	3.00 %	-	-	-	-	1.70 %	0.05 %
	I/IT	-	-	-	-	-	-	-	0.64 %	0.01 %
	N/NT	-	-	-	-	-	-	-	0.64 %	0.05 %
	P/PT	2.00 %	-	2.00 %	-	-	-	-	0.64 %	0.05 %
	R/RT	-	-	-	-	-	-	-	0.70 %	0.05 %
	S/ST	-	-	-	-	-	-	-	0.64 %	0.05 %
	W/WT	-	-	-	-	-	-	-	0.46 %	0.01 %
	X/XT	-	-	-	-	-	-	-	0.64 %	0.01 %
	Y/YT	-	-	-	-	-	-	-	0.64 %	0.05 %
Allianz Capital Plus Global	A/AT	5.00 %	-	5.00 %	-	-	-	-	1.40 %	0.05 %
	C/CT	5.00 %	-	5.00 %	-	-	-	-	2.10 %	0.05 %
	I/IT	2.00 %	-	2.00 %	-	-	-	-	0.89 %	0.01 %
	N/NT	-	-	-	-	-	-	-	0.71 %	0.05 %
	P/PT	2.00 %	-	2.00 %	-	-	-	-	0.89 %	0.05 %
	R/RT	-	-	-	-	-	-	-	0.95 %	0.05 %
	S/ST	-	-	-	-	-	-	-	0.95 %	0.05 %
	W/WT	-	-	-	-	-	-	-	0.71 %	0.01 %
	X/XT	-	-	-	-	-	-	-	0.62 %	0.01 %
	Y/YT	-	-	-	-	-	-	-	0.66 %	0.05 %
Allianz China A Opportunities	A/AT	5.00 %	-	5.00 %	-	-	-	-	2.25 %	0.05 %
	I/IT	2.00 %	-	2.00 %	-	-	-	-	1.40 %	0.01 %
	P/PT	2.00 %	-	2.00 %	-	-	-	-	1.85 %	0.05 %
	R/RT	-	-	-	-	-	-	-	1.68 %	0.05 %
	W/WT	-	-	-	-	-	-	-	1.85 %	0.01 %
X/XT	-	-	-	-	-	-	-	1.85 %	0.01 %	

- Allianz Global Investors Fund -

Sub-Fund Name	Share Class	Sales Charge	Placement Fee	Conversion Fee	Redemption Fee	Disinvestment Fee	Exit Fee	CDSC	All-in-Fee (p.a.)	Taxe d' Abonnement (p.a.)
Allianz China A-Shares	A/AT	5.00 %	-	5.00 %	-	-	-	-	2.25 %	0.05 %
	C/CT	5.00 %	-	5.00 %	-	-	-	-	3.00 %	0.05 %
	E/ET	-	-	-	-	-	-	-	1.65 %	0.05 %
	I/IT	2.00 %	-	2.00 %	-	-	-	-	1.40 %	0.01 %
	N/NT	-	-	-	-	-	-	-	1.85 %	0.05 %
	P/PT	2.00 %	-	2.00 %	-	-	-	-	1.85 %	0.05 %
	R/RT	-	-	-	-	-	-	-	1.68 %	0.05 %
	S/ST	7.00 %	-	7.00 %	-	-	-	-	2.00 %	0.05 %
	W/WT	-	-	-	-	-	-	-	1.85 %	0.01 %
	X/XT	-	-	-	-	-	-	-	1.85 %	0.01 %
Y/YT	2.00 %	-	2.00 %	-	-	-	-	1.40 %	0.05 %	
Allianz China Equity	A/AT	5.00 %	-	5.00 %	-	-	-	-	2.25 %	0.05 %
	AT (SGD)	5.00 %	-	5.00 %	-	-	-	-	1.85 %	0.05 %
	C/CT	5.00 %	-	5.00 %	-	-	-	-	3.00 %	0.05 %
	E/ET	-	-	-	-	-	-	-	1.65 %	0.05 %
	I/IT	-	-	-	-	-	-	-	1.28 %	0.01 %
	N/NT	-	-	-	-	-	-	-	0.93 %	0.05 %
	P/PT	-	-	-	-	-	-	-	1.28 %	0.05 %
	P2/PT2	-	-	-	-	-	-	-	0.93 %	0.05 %
	R/RT	-	-	-	-	-	-	-	1.80 %	0.05 %
	S/ST	7.00 %	-	7.00 %	-	-	-	-	2.19 %	0.05 %
	W/WT	-	-	-	-	-	-	-	0.93 %	0.01 %
	X/XT	-	-	-	-	-	-	-	1.85 %	0.01 %
	Y/YT	-	-	-	-	-	-	-	1.28 %	0.05 %
Allianz China Future Technologies	A/AT	5.00 %	-	5.00 %	-	-	-	-	2.25 %	0.05 %
	I/IT	2.00 %	-	2.00 %	-	-	-	-	1.40 %	0.01 %
	P/PT	2.00 %	-	2.00 %	-	-	-	-	1.85 %	0.05 %
	R/RT	-	-	-	-	-	-	-	1.68 %	0.05 %
	W/WT	-	-	-	-	-	-	-	1.85 %	0.01 %
	X/XT	-	-	-	-	-	-	-	1.85 %	0.01 %
Allianz China Healthy Living	A/AT	5.00 %	-	5.00 %	-	-	-	-	2.25 %	0.05 %
	I/IT	2.00 %	-	2.00 %	-	-	-	-	1.40 %	0.01 %
	P/PT	2.00 %	-	2.00 %	-	-	-	-	1.85 %	0.05 %
	R/RT	-	-	-	-	-	-	-	1.68 %	0.05 %
	W/WT	-	-	-	-	-	-	-	1.85 %	0.01 %
	X/XT	-	-	-	-	-	-	-	1.85 %	0.01 %
Allianz China Multi Income Plus	A/AT	5.00 %	-	5.00 %	-	-	-	-	2.25 %	0.05 %
	C/CT	5.00 %	-	5.00 %	-	-	-	-	3.00 %	0.05 %
	I/IT	2.00 %	-	2.00 %	-	-	-	-	0.95 %	0.01 %
	I (USD)	2.00 %	-	2.00 %	-	-	-	-	1.08 %	0.01 %
	N/NT	-	-	-	-	-	-	-	1.65 %	0.05 %
	P/PT	2.00 %	-	2.00 %	-	-	-	-	1.65 %	0.05 %
	P8/PT8/P9/PT9	2.00 %	-	2.00 %	-	-	-	-	1.26 %	0.05 %
	R/RT	-	-	-	-	-	-	-	1.80 %	0.05 %
	S/ST	7.00 %	-	7.00 %	-	-	-	-	1.65 %	0.05 %
	W/WT	-	-	-	-	-	-	-	1.65 %	0.01 %
	X/XT	-	-	-	-	-	-	-	1.65 %	0.01 %
Y/YT	-	-	-	-	-	-	-	0.95 %	0.05 %	
Allianz China Strategic Bond	A/AT	3.00 %	-	3.00 %	-	-	-	-	0.65 %	0.05 %
	C/CT	3.00 %	-	3.00 %	-	-	-	-	0.85 %	0.05 %
	I/IT	-	-	-	-	-	-	-	0.51 %	0.01 %
	N/NT	-	-	-	-	-	-	-	0.54 %	0.05 %
	P/PT	-	-	-	-	-	-	-	0.51 %	0.05 %
	R/RT	-	-	-	-	-	-	-	0.55 %	0.05 %
	S/ST	5.00 %	-	5.00 %	-	-	-	-	0.64 %	0.05 %
	W/WT	-	-	-	-	-	-	-	0.54 %	0.01 %
	X/XT	-	-	-	-	-	-	-	0.54 %	0.01 %
	Y/YT	-	-	-	-	-	-	-	0.51 %	0.05 %

- Allianz Global Investors Fund -

Sub-Fund Name	Share Class	Sales Charge	Placement Fee	Conversion Fee	Redemption Fee	Disinvestment Fee	Exit Fee	CDSC	All-in-Fee (p.a.)	Taxe d' Abonnement (p.a.)
Allianz China Thematica	A/AT	5.00 %	-	5.00 %	-	-	-	-	2.25 %	0.05 %
	I/IT	2.00 %	-	2.00 %	-	-	-	-	1.40 %	0.01 %
	P/PT	2.00 %	-	2.00 %	-	-	-	-	1.85 %	0.05 %
	R/RT	-	-	-	-	-	-	-	1.68 %	0.05 %
	W/WT	-	-	-	-	-	-	-	1.85 %	0.01 %
	X/XT	-	-	-	-	-	-	-	1.85 %	0.01 %
Allianz Clean Planet	A/AT	5.00 %	-	5.00 %	-	-	-	-	2.35 %	0.05 %
	C/CT	-	-	-	-	-	-	-	3.10 %	0.05 %
	I/IT	2.00 %	-	2.00 %	-	-	-	-	1.38 %	0.01 %
	P/PT	-	-	-	-	-	-	-	1.38 %	0.05 %
	R/RT	-	-	-	-	-	-	-	1.48 %	0.05 %
	W/WT	-	-	-	-	-	-	-	1.03 %	0.01 %
	X/XT	-	-	-	-	-	-	-	1.38 %	0.01 %
Y/YT	-	-	-	-	-	-	-	0.92 %	0.05 %	
Allianz Climate Transition	A/AT	5.00 %	-	5.00 %	-	-	-	-	2.35 %	0.05 %
	C/CT	-	-	-	-	-	-	-	3.10 %	0.05 %
	I/IT	2.00 %	-	2.00 %	-	-	-	-	1.38 %	0.01 %
	P/PT	-	-	-	-	-	-	-	1.38 %	0.05 %
	R/RT	-	-	-	-	-	-	-	1.48 %	0.05 %
	W/WT	-	-	-	-	-	-	-	1.03 %	0.01 %
	X/XT	-	-	-	-	-	-	-	1.38 %	0.01 %
Y/YT	-	-	-	-	-	-	-	1.38 %	0.05 %	
Allianz Convertible Bond	A/AT	3.00 %	-	3.00 %	-	-	-	-	1.35 %	0.05 %
	C/CT	3.00 %	-	3.00 %	-	-	-	-	2.10 %	0.05 %
	I/IT	2.00 %	-	2.00 %	-	-	-	-	0.79 %	0.01 %
	N/NT	-	-	-	-	-	-	-	1.06 %	0.05 %
	P/PT	2.00 %	-	2.00 %	-	-	-	-	0.79 %	0.05 %
	R/RT	-	-	-	-	-	-	-	1.10 %	0.05 %
	S/ST	7.00 %	-	7.00 %	-	-	-	-	1.26 %	0.05 %
	W/WT	-	-	-	-	-	-	-	0.55 %	0.01 %
	X/XT	-	-	-	-	-	-	-	1.06 %	0.01 %
Y/YT	-	-	-	-	-	-	-	0.79 %	0.05 %	
Allianz Coupon Select Plus V	A/AT	-	2.00 %	-	-	-	2.00 %	-	1.65 %	0.05 %
	C/CT	-	2.00 %	-	-	-	2.00 %	-	2.40 %	0.05 %
	I/IT	-	2.00 %	-	-	-	2.00 %	-	1.10 %	0.01 %
	N/NT	-	2.00 %	-	-	-	2.00 %	-	1.10 %	0.05 %
	P/PT	-	2.00 %	-	-	-	2.00 %	-	1.10 %	0.05 %
	R/RT	-	2.00 %	-	-	-	2.00 %	-	1.30 %	0.05 %
	S/ST	-	2.00 %	-	-	-	2.00 %	-	1.10 %	0.05 %
	W/WT	-	2.00 %	-	-	-	2.00 %	-	1.10 %	0.01 %
	X/XT	-	2.00 %	-	-	-	2.00 %	-	1.00 %	0.01 %
Y/YT	-	2.00 %	-	-	-	2.00 %	-	1.10 %	0.05 %	
Allianz Coupon Select Plus VI	A/AT	-	2.50 %	-	-	-	2.50 %	-	1.65 %	0.05 %
	C/CT	-	2.50 %	-	-	-	2.50 %	-	2.40 %	0.05 %
	I/IT	-	2.50 %	-	-	-	2.50 %	-	1.10 %	0.01 %
	N/NT	-	2.50 %	-	-	-	2.50 %	-	1.10 %	0.05 %
	P/PT	-	2.50 %	-	-	-	2.50 %	-	1.10 %	0.05 %
	R/RT	-	2.50 %	-	-	-	2.50 %	-	1.30 %	0.05 %
	S/ST	-	2.50 %	-	-	-	2.50 %	-	1.10 %	0.05 %
	W/WT	-	2.50 %	-	-	-	2.50 %	-	1.10 %	0.01 %
	X/XT	-	2.50 %	-	-	-	2.50 %	-	1.00 %	0.01 %
Y/YT	-	2.50 %	-	-	-	2.50 %	-	1.10 %	0.05 %	
Allianz Credit Opportunities	A/AT	2.50 %	-	2.50 %	-	-	-	-	1.69 %	0.05 %
	C/CT	3.00 %	-	3.00 %	-	-	-	-	2.44 %	0.05 %
	I/IT	2.00 %	-	2.00 %	-	-	-	-	1.15 %	0.01 %
	N/NT	-	-	-	-	-	-	-	1.00 %	0.05 %
	P/PT	2.00 %	-	2.00 %	-	-	-	-	1.15 %	0.05 %
	R/RT	-	-	-	-	-	-	-	1.32 %	0.05 %
	S/ST	5.00 %	-	5.00 %	-	-	-	-	1.00 %	0.05 %
	W/WT	-	-	-	-	-	-	-	1.15 %	0.01 %
	X/XT	-	-	-	-	-	-	-	1.15 %	0.01 %
Y/YT	-	-	-	-	-	-	-	1.15 %	0.05 %	

- Allianz Global Investors Fund -

Sub-Fund Name	Share Class	Sales Charge	Placement Fee	Conversion Fee	Redemption Fee	Disinvestment Fee	Exit Fee	CDSC	All-in-Fee (p.a.)	Taxe d' Abonnement (p.a.)
Allianz Credit Opportunities Plus	A/AT	2.50 %	-	2.50 %	-	-	-	-	2.00 %	0.05 %
	C/CT	3.00 %	-	3.00 %	-	-	-	-	2.75 %	0.05 %
	I/IT	2.00 %	-	2.00 %	-	-	-	-	1.70 %	0.01 %
	N/NT	-	-	-	-	-	-	-	1.70 %	0.05 %
	P/PT	2.00 %	-	2.00 %	-	-	-	-	1.70 %	0.05 %
	R/RT	-	-	-	-	-	-	-	1.70 %	0.05 %
	W/WT	-	-	-	-	-	-	-	1.70 %	0.01 %
	X/XT	-	-	-	-	-	-	-	1.70 %	0.01 %
Y/YT	-	-	-	-	-	-	-	1.70 %	0.05 %	
Allianz Cyber Security	A/AT	5.00 %	-	5.00 %	-	-	-	-	2.35 %	0.05 %
	B/BT	-	-	5.00 %	-	-	-	3.00 %	3.35 %	0.05 %
	C/CT	-	-	-	-	-	-	-	3.10 %	0.05 %
	I/IT	2.00 %	-	2.00 %	-	-	-	-	1.38 %	0.01 %
	P/PT	-	-	-	-	-	-	-	1.38 %	0.05 %
	R/RT	-	-	-	-	-	-	-	1.48 %	0.05 %
	W/WT	-	-	-	-	-	-	-	1.03 %	0.01 %
	X/XT	-	-	-	-	-	-	-	1.38 %	0.01 %
Y/YT	-	-	-	-	-	-	-	0.92 %	0.05 %	
Allianz Dynamic Allocation Plus Equity	A/AT	5.00 %	-	5.00 %	-	-	-	-	1.75 %	0.05 %
	C/CT	5.00 %	-	5.00 %	-	-	-	-	3.25 %	0.05 %
	I/IT	2.00 %	-	2.00 %	-	-	-	-	0.99 %	0.01 %
	I3/IT3	2.00 %	-	2.00 %	-	-	-	-	1.69 %	0.01 %
	N/NT	-	-	-	-	-	-	-	1.75 %	0.05 %
	P/PT	2.00 %	-	2.00 %	-	-	-	-	0.99 %	0.05 %
	P3/PT3	2.00 %	-	2.00 %	-	-	-	-	1.69 %	0.05 %
	R/RT	-	-	-	-	-	-	-	1.05 %	0.05 %
	R3/RT3	-	-	-	-	-	-	-	1.75 %	0.05 %
	S/ST	7.00 %	-	7.00 %	-	-	-	-	1.75 %	0.05 %
W/WT	-	-	-	-	-	-	-	0.99 %	0.01 %	
X/XT	-	-	-	-	-	-	-	1.75 %	0.01 %	
Y/YT	-	-	-	-	-	-	-	0.99 %	0.05 %	
Allianz Dynamic Asian High Yield Bond	A/AT	5.00 %	-	5.00 %	-	-	-	-	1.50 %	0.05 %
	B/BT	-	-	5.00 %	-	-	-	3.00 %	2.50 %	0.05 %
	C/CT	5.00 %	-	5.00 %	-	-	-	-	2.25 %	0.05 %
	I/IT	2.00 %	-	2.00 %	-	-	-	-	0.82 %	0.01 %
	N/NT	-	-	-	-	-	-	-	1.60 %	0.05 %
	P/PT	2.00 %	-	2.00 %	-	-	-	-	0.82 %	0.05 %
	P8/PT8/P9/PT9	2.00 %	-	2.00 %	-	-	-	-	0.95 %	0.05 %
	R/RT	-	-	-	-	-	-	-	1.40 %	0.05 %
	S/ST	7.00 %	-	7.00 %	-	-	-	-	1.60 %	0.05 %
	W/WT	-	-	-	-	-	-	-	0.57 %	0.01 %
X/XT	-	-	-	-	-	-	-	1.60 %	0.01 %	
Y/YT	-	-	-	-	-	-	-	0.82 %	0.05 %	
Allianz Dynamic Commodities	A/AT	5.00 %	-	5.00 %	-	-	-	-	1.55 %	0.05 %
	C/CT	5.00 %	-	5.00 %	-	-	-	-	2.31 %	0.05 %
	I/IT	2.00 %	-	2.00 %	-	-	-	-	0.83 %	0.01 %
	N/NT	-	-	-	-	-	-	-	1.24 %	0.05 %
	P/PT	2.00 %	-	2.00 %	-	-	-	-	1.24 %	0.05 %
	R/RT	-	-	-	-	-	-	-	1.45 %	0.05 %
	S/ST	7.00 %	-	7.00 %	-	-	-	-	1.47 %	0.05 %
	W/WT	-	-	-	-	-	-	-	1.24 %	0.01 %
X/XT	-	-	-	-	-	-	-	1.24 %	0.01 %	
Y/YT	-	-	-	-	-	-	-	0.83 %	0.05 %	

- Allianz Global Investors Fund -

Sub-Fund Name	Share Class	Sales Charge	Placement Fee	Conversion Fee	Redemption Fee	Disinvestment Fee	Exit Fee	CDSC	All-in-Fee (p.a.)	Taxe d' Abonnement (p.a.)
Allianz Dynamic Multi Asset Strategy SRI 15	A/AT	3.00 %	-	3.00 %	-	-	-	-	1.45 %	0.05 %
	C/CT	3.00 %	-	3.00 %	-	-	-	-	2.00 %	0.05 %
	C6/CT6	0.50 %	2.50 %	0.50 %	-	-	2.50 %	-	2.00 %	0.05 %
	I/IT	2.00 %	-	2.00 %	-	-	-	-	0.74 %	0.01 %
	N/NT	-	-	-	-	-	-	-	1.45 %	0.05 %
	P/PT	2.00 %	-	2.00 %	-	-	-	-	1.45 %	0.05 %
	R/RT	-	-	-	-	-	-	-	1.45 %	0.05 %
	S/ST	7.00 %	-	7.00 %	-	-	-	-	1.45 %	0.05 %
	W/WT	-	-	-	-	-	-	-	0.52 %	0.01 %
	W6/WT6	-	2.50 %	-	-	-	2.50 %	-	0.52 %	0.01 %
X/XT	-	-	-	-	-	-	-	1.45 %	0.01 %	
Y/YT	-	-	-	-	-	-	-	0.74 %	0.05 %	
Allianz Dynamic Multi Asset Strategy SRI 50	A/AT	4.00 %	-	4.00 %	-	-	-	-	1.65 %	0.05 %
	C/CT	4.00 %	-	4.00 %	-	-	-	-	2.20 %	0.05 %
	C6/CT6	1.50 %	2.50 %	1.50 %	-	-	2.50 %	-	2.20 %	0.05 %
	I/IT	2.00 %	-	2.00 %	-	-	-	-	0.79 %	0.01 %
	N/NT	-	-	-	-	-	-	-	1.15 %	0.05 %
	P/PT	2.00 %	-	2.00 %	-	-	-	-	1.15 %	0.05 %
	R/RT	-	-	-	-	-	-	-	1.35 %	0.05 %
	S/ST	7.00 %	-	7.00 %	-	-	-	-	1.38 %	0.05 %
	W/WT	-	-	-	-	-	-	-	0.55 %	0.01 %
	W6/WT6	-	2.50 %	-	-	-	2.50 %	-	0.55 %	0.01 %
X/XT	-	-	-	-	-	-	-	1.15 %	0.01 %	
Y/YT	-	-	-	-	-	-	-	0.79 %	0.05 %	
Allianz Dynamic Multi Asset Strategy SRI 75	A/AT	5.00 %	-	5.00 %	-	-	-	-	1.85 %	0.05 %
	C/CT	5.00 %	-	5.00 %	-	-	-	-	2.40 %	0.05 %
	C6/CT6	2.00 %	3.00 %	2.00 %	-	-	3.00 %	-	2.40 %	0.05 %
	F/FT	-	-	-	-	-	-	-	0.20 %	0.01 %
	I/IT	2.00 %	-	2.00 %	-	-	-	-	0.87 %	0.01 %
	N/NT	-	-	-	-	-	-	-	1.70 %	0.05 %
	P/PT	2.00 %	-	2.00 %	-	-	-	-	1.70 %	0.05 %
	R/RT	-	-	-	-	-	-	-	1.70 %	0.05 %
	S/ST	7.00 %	-	7.00 %	-	-	-	-	1.70 %	0.05 %
	W/WT	-	-	-	-	-	-	-	0.60 %	0.01 %
W6/WT6	-	3.00 %	-	-	-	3.00 %	-	0.60 %	0.01 %	
X/XT	-	-	-	-	-	-	-	1.70 %	0.01 %	
Y/YT	-	-	-	-	-	-	-	0.87 %	0.05 %	
Allianz Emerging Asia Equity	A/AT	5.00 %	-	5.00 %	-	-	-	-	2.25 %	0.05 %
	C/CT	5.00 %	-	5.00 %	-	-	-	-	3.00 %	0.05 %
	I/IT	-	-	-	-	-	-	-	1.28 %	0.01 %
	N/NT	-	-	-	-	-	-	-	1.85 %	0.05 %
	P/PT	-	-	-	-	-	-	-	1.85 %	0.05 %
	R/RT	-	-	-	-	-	-	-	2.20 %	0.05 %
	S/ST	7.00 %	-	7.00 %	-	-	-	-	2.19 %	0.05 %
	W/WT	-	-	-	-	-	-	-	1.85 %	0.01 %
	X/XT	-	-	-	-	-	-	-	1.85 %	0.01 %
Y/YT	-	-	-	-	-	-	-	1.28 %	0.05 %	
Allianz Emerging Europe Equity	A/AT	5.00 %	-	5.00 %	-	-	-	-	2.55 %	0.05 %
	C/CT	5.00 %	-	5.00 %	-	-	-	-	3.30 %	0.05 %
	I/IT	2.00 %	-	2.00 %	-	-	-	-	1.58 %	0.01 %
	P/PT	2.00 %	-	2.00 %	-	-	-	-	1.58 %	0.05 %
	R/RT	-	-	-	-	-	-	-	1.68 %	0.05 %
	W/WT	-	-	-	-	-	-	-	1.23 %	0.01 %
Y/YT	-	-	-	-	-	-	-	1.12 %	0.05 %	

- Allianz Global Investors Fund -

Sub-Fund Name	Share Class	Sales Charge	Placement Fee	Conversion Fee	Redemption Fee	Disinvestment Fee	Exit Fee	CDSC	All-in-Fee (p.a.)	Taxe d' Abonnement (p.a.)
Allianz Emerging Markets Equity	A/AT	5.00 %	-	5.00 %	-	-	-	-	1.90 %	0.05 %
	C/CT	5.00 %	-	5.00 %	-	-	-	-	2.65 %	0.05 %
	E/ET	-	-	-	-	-	-	-	1.65 %	0.05 %
	I/IT	2.00 %	-	2.00 %	-	-	-	-	1.10 %	0.01 %
	N/NT	-	-	-	-	-	-	-	2.00 %	0.05 %
	P/PT	2.00 %	-	2.00 %	-	-	-	-	2.00 %	0.05 %
	R/RT	-	-	-	-	-	-	-	1.50 %	0.05 %
	S/ST	7.00 %	-	7.00 %	-	-	-	-	2.00 %	0.05 %
	W/WT	-	-	-	-	-	-	-	0.82 %	0.01 %
	X/XT	-	-	-	-	-	-	-	2.00 %	0.01 %
Y/YT	-	-	-	-	-	-	-	1.10 %	0.05 %	
Allianz Emerging Markets Equity Opportunities	A/AT	5.00 %	-	5.00 %	-	-	-	-	2.50 %	0.05 %
	C/CT	5.00 %	-	5.00 %	-	-	-	-	2.75 %	0.05 %
	F/FT	-	-	-	-	-	-	-	1.75 %	0.01 %
	I/IT	2.00 %	-	2.00 %	-	-	-	-	1.15 %	0.01 %
	N/NT	-	-	-	-	-	-	-	1.75 %	0.05 %
	P/PT	2.00 %	-	2.00 %	-	-	-	-	1.15 %	0.05 %
	R/RT	-	-	-	-	-	-	-	1.65 %	0.05 %
	S/ST	7.00 %	-	7.00 %	-	-	-	-	1.75 %	0.05 %
	W/WT	-	-	-	-	-	-	-	0.85 %	0.01 %
	X/XT	-	-	-	-	-	-	-	1.75 %	0.01 %
Y/YT	-	-	-	-	-	-	-	1.15 %	0.05 %	
Allianz Emerging Markets Equity SRI	A/AT	5.00 %	-	5.00 %	-	-	-	-	2.20 %	0.05 %
	C/CT	5.00 %	-	5.00 %	-	-	-	-	2.65 %	0.05 %
	E/ET	-	-	-	-	-	-	-	1.95 %	0.05 %
	I/IT	2.00 %	-	2.00 %	-	-	-	-	1.40 %	0.01 %
	P/PT	2.00 %	-	2.00 %	-	-	-	-	2.00 %	0.05 %
	R/RT	-	-	-	-	-	-	-	1.50 %	0.05 %
	W/WT	-	-	-	-	-	-	-	1.12 %	0.01 %
	X/XT	-	-	-	-	-	-	-	1.12 %	0.01 %
Y/YT	-	-	-	-	-	-	-	1.12 %	0.05 %	
Allianz Emerging Markets Multi Asset Income	A/AT	5.00 %	-	5.00 %	-	-	-	-	2.00 %	0.05 %
	C/CT	5.00 %	-	5.00 %	-	-	-	-	2.75 %	0.05 %
	I/IT	2.00 %	-	2.00 %	-	-	-	-	1.19 %	0.01 %
	P/PT	2.00 %	-	2.00 %	-	-	-	-	1.19 %	0.05 %
	R/RT	-	-	-	-	-	-	-	1.25 %	0.05 %
	W/WT	-	-	-	-	-	-	-	0.89 %	0.01 %
Y/YT	-	-	-	-	-	-	-	0.80 %	0.05 %	
Allianz Emerging Markets Select Bond	A/AT	5.00 %	-	5.00 %	-	-	-	-	2.00 %	0.05 %
	B/BT	-	-	5.00 %	-	-	-	3.00 %	3.00 %	0.05 %
	C/CT	5.00 %	-	5.00 %	-	-	-	-	2.75 %	0.05 %
	I/IT	-	-	-	-	-	-	-	1.45 %	0.01 %
	N/NT	-	-	-	-	-	-	-	1.45 %	0.05 %
	P/PT	-	-	-	-	-	-	-	1.45 %	0.05 %
	R/RT	-	-	-	-	-	-	-	1.45 %	0.05 %
	S/ST	7.00 %	-	7.00 %	-	-	-	-	1.50 %	0.05 %
	W/WT	-	-	-	-	-	-	-	1.45 %	0.01 %
	X/XT	-	-	-	-	-	-	-	1.45 %	0.01 %
Y/YT	-	-	-	-	-	-	-	1.45 %	0.05 %	
Allianz Emerging Markets Short Duration Bond	A/AT	5.00 %	-	5.00 %	-	-	-	-	0.99 %	0.05 %
	C/CT	5.00 %	-	5.00 %	-	-	-	-	1.39 %	0.05 %
	I/IT	-	-	-	-	-	-	-	0.55 %	0.01 %
	I2 (H2-EUR)	-	-	-	-	-	-	-	0.45 %	0.01 %
	N/NT	-	-	-	-	-	-	-	1.45 %	0.05 %
	P/PT	-	-	-	-	-	-	-	0.55 %	0.05 %
	P2 (H2-EUR)	-	-	-	-	-	-	-	0.45 %	0.05 %
	R/RT	-	-	-	-	-	-	-	0.80 %	0.05 %
	S/ST	7.00 %	-	7.00 %	-	-	-	-	1.50 %	0.05 %
	W/WT	-	-	-	-	-	-	-	1.45 %	0.01 %
	W (H2-EUR)	-	-	-	-	-	-	-	0.40 %	0.01 %
X/XT	-	-	-	-	-	-	-	1.45 %	0.01 %	
Y/YT	-	-	-	-	-	-	-	0.55 %	0.05 %	

Sub-Fund Name	Share Class	Sales Charge	Placement Fee	Conversion Fee	Redemption Fee	Disinvestment Fee	Exit Fee	CDSC	All-in-Fee (p.a.)	Taxe d' Abonnement (p.a.)
Allianz Emerging Markets Sovereign Bond	A/AT	5.00 %	-	5.00 %	-	-	-	-	1.70 %	0.05 %
	C/CT	5.00 %	-	5.00 %	-	-	-	-	3.20 %	0.05 %
	I/IT	2.00 %	-	2.00 %	-	-	-	-	1.07 %	0.01 %
	N/NT	-	-	-	-	-	-	-	0.82 %	0.05 %
	P/PT	2.00 %	-	2.00 %	-	-	-	-	1.07 %	0.05 %
	R/RT	-	-	-	-	-	-	-	1.08 %	0.05 %
	S/ST	7.00 %	-	7.00 %	-	-	-	-	1.08 %	0.05 %
	W/WT	-	-	-	-	-	-	-	0.82 %	0.01 %
	X/XT	-	-	-	-	-	-	-	0.69 %	0.01 %
Y/YT	-	-	-	-	-	-	-	0.74 %	0.05 %	
Allianz Emerging Markets SRI Bond	A/AT	5.00 %	-	5.00 %	-	-	-	-	1.70 %	0.05 %
	C/CT	5.00 %	-	5.00 %	-	-	-	-	3.20 %	0.05 %
	I/IT	2.00 %	-	2.00 %	-	-	-	-	1.07 %	0.01 %
	N/NT	-	-	-	-	-	-	-	0.82 %	0.05 %
	P/PT	2.00 %	-	2.00 %	-	-	-	-	1.07 %	0.05 %
	R/RT	-	-	-	-	-	-	-	1.08 %	0.05 %
	S/ST	7.00 %	-	7.00 %	-	-	-	-	1.08 %	0.05 %
	W/WT	-	-	-	-	-	-	-	0.82 %	0.01 %
	X/XT	-	-	-	-	-	-	-	0.69 %	0.01 %
Y/YT	-	-	-	-	-	-	-	0.74 %	0.05 %	
Allianz Emerging Markets SRI Corporate Bond	A/AT	5.00 %	-	5.00 %	-	-	-	-	1.75 %	0.05 %
	C/CT	5.00 %	-	5.00 %	-	-	-	-	3.25 %	0.05 %
	I/IT	2.00 %	-	2.00 %	-	-	-	-	1.07 %	0.01 %
	N/NT	-	-	-	-	-	-	-	0.82 %	0.05 %
	P/PT	2.00 %	-	2.00 %	-	-	-	-	1.07 %	0.05 %
	R/RT	-	-	-	-	-	-	-	1.13 %	0.05 %
	S/ST	7.00 %	-	7.00 %	-	-	-	-	1.13 %	0.05 %
	W/WT	-	-	-	-	-	-	-	0.82 %	0.01 %
	X/XT	-	-	-	-	-	-	-	0.69 %	0.01 %
Y/YT	-	-	-	-	-	-	-	0.74 %	0.05 %	
Allianz Enhanced All China Equity	A/AT	5.00 %	-	5.00 %	-	-	-	-	2.25 %	0.05 %
	C/CT	5.00 %	-	5.00 %	-	-	-	-	3.00 %	0.05 %
	I/IT	-	-	-	-	-	-	-	1.85 %	0.01 %
	N/NT	-	-	-	-	-	-	-	1.85 %	0.05 %
	P/PT	-	-	-	-	-	-	-	1.85 %	0.05 %
	R/RT	-	-	-	-	-	-	-	2.20 %	0.05 %
	S/ST	7.00 %	-	7.00 %	-	-	-	-	2.19 %	0.05 %
	W/WT	-	-	-	-	-	-	-	1.85 %	0.01 %
	X/XT	-	-	-	-	-	-	-	1.85 %	0.01 %
Y/YT	-	-	-	-	-	-	-	1.85 %	0.05 %	
Allianz Enhanced Short Term Euro	A/AT	-	-	-	-	-	-	-	0.45 %	0.05 %
	C/CT	-	-	-	-	-	-	-	0.50 %	0.05 %
	I/IT	-	-	-	-	-	-	-	0.23 %	0.01 %
	N/NT	-	-	-	-	-	-	-	0.42 %	0.05 %
	P/PT	-	-	-	-	-	-	-	0.42 %	0.05 %
	R/RT	-	-	-	-	-	-	-	0.45 %	0.05 %
	S/ST	7.00 %	-	7.00 %	-	-	-	-	0.45 %	0.05 %
	W/WT	-	-	-	-	-	-	-	0.42 %	0.01 %
	X/XT	-	-	-	-	-	-	-	0.42 %	0.01 %
Y/YT	-	-	-	-	-	-	-	0.23 %	0.05 %	
Allianz Euro Balanced	A/AT	5.00 %	-	5.00 %	-	-	-	-	1.59 %	0.05 %
	C/CT	5.00 %	-	5.00 %	-	-	-	-	1.59 %	0.05 %
	I/IT	-	-	-	-	-	-	-	0.95 %	0.01 %
	I2/IT2	-	-	-	-	-	-	-	1.35 %	0.01 %
	I4/IT4	-	-	-	-	-	-	-	0.60 %	0.01 %
	N/NT	-	-	-	-	-	-	-	0.71 %	0.05 %
	P/PT	2.00 %	-	2.00 %	-	-	-	-	0.95 %	0.05 %
	R/RT	-	-	-	-	-	-	-	0.99 %	0.05 %
	S/ST	-	-	-	-	-	-	-	0.99 %	0.05 %
W/WT	-	-	-	-	-	-	-	0.71 %	0.01 %	
X/XT	-	-	-	-	-	-	-	0.59 %	0.01 %	
Y/YT	-	-	-	-	-	-	-	0.64 %	0.05 %	

Sub-Fund Name	Share Class	Sales Charge	Placement Fee	Conversion Fee	Redemption Fee	Disinvestment Fee	Exit Fee	CDSC	All-in-Fee (p.a.)	Taxe d' Abonnement (p.a.)
Allianz Euro Bond	A/AT	5.00 %	-	5.00 %	-	-	-	-	1.34 %	0.05 %
	AQ (EUR)	5.00 %	-	5.00 %	-	-	-	-	1.69 %	0.05 %
	C/CT	5.00 %	-	5.00 %	-	-	-	-	1.44 %	0.05 %
	F/FT	-	-	-	-	-	-	-	0.20 %	0.01 %
	I/IT	2.00 %	-	2.00 %	-	-	-	-	0.75 %	0.01 %
	N/NT	-	-	-	-	-	-	-	1.05 %	0.05 %
	P/PT	2.00 %	-	2.00 %	-	-	-	-	1.05 %	0.05 %
	R/RT	-	-	-	-	-	-	-	1.20 %	0.05 %
	S/ST	7.00 %	-	7.00 %	-	-	-	-	1.26 %	0.05 %
	W/WT	-	-	-	-	-	-	-	1.05 %	0.01 %
Allianz Euro Bond Short Term 1-3 Plus	A/AT	5.00 %	-	5.00 %	-	-	-	-	1.15 %	0.05 %
	C/CT	5.00 %	-	5.00 %	-	-	-	-	1.90 %	0.05 %
	F/FT	-	-	-	-	-	-	-	0.45 %	0.01 %
	I/IT	2.00 %	-	2.00 %	-	-	-	-	0.71 %	0.01 %
	N/NT	-	-	-	-	-	-	-	0.71 %	0.05 %
	P/PT	2.00 %	-	2.00 %	-	-	-	-	0.71 %	0.05 %
	R/RT	-	-	-	-	-	-	-	0.90 %	0.05 %
	S/ST	7.00 %	-	7.00 %	-	-	-	-	0.75 %	0.05 %
	W/WT	-	-	-	-	-	-	-	0.71 %	0.01 %
	X/XT	-	-	-	-	-	-	-	0.61 %	0.01 %
Allianz Euro Credit SRI	A/AT	5.00 %	-	5.00 %	-	-	-	-	2.00 %	0.05 %
	C/CT	5.00 %	-	5.00 %	-	-	-	-	2.75 %	0.05 %
	I/IT	2.00 %	-	2.00 %	-	-	-	-	1.00 %	0.01 %
	N/NT	-	-	-	-	-	-	-	1.00 %	0.05 %
	P/PT	2.00 %	-	2.00 %	-	-	-	-	1.00 %	0.05 %
	R/RT	-	-	-	-	-	-	-	0.90 %	0.05 %
	S/ST	7.00 %	-	7.00 %	-	-	-	-	1.00 %	0.05 %
	W/WT	-	-	-	-	-	-	-	0.42 %	0.01 %
	X/XT	-	-	-	-	-	-	-	1.00 %	0.01 %
	Y/YT	-	-	-	-	-	-	-	1.00 %	0.05 %
Allianz Euro Government Bond	A/AT	5.00 %	-	5.00 %	-	-	-	-	0.85 %	0.05 %
	C/CT	5.00 %	-	5.00 %	-	-	-	-	0.85 %	0.05 %
	I/IT	-	-	-	-	-	-	-	0.56 %	0.01 %
	I2/IT2	-	-	-	-	-	-	-	0.80 %	0.01 %
	I4/IT4	-	-	-	-	-	-	-	0.40 %	0.01 %
	N/NT	-	-	-	-	-	-	-	0.46 %	0.05 %
	P/PT	2.00 %	-	2.00 %	-	-	-	-	0.56 %	0.05 %
	R/RT	-	-	-	-	-	-	-	0.60 %	0.05 %
	S/ST	-	-	-	-	-	-	-	0.60 %	0.05 %
	W/WT	-	-	-	-	-	-	-	0.46 %	0.01 %
Allianz Euro High Yield Bond	A/AT	3.00 %	-	3.00 %	-	-	-	-	1.35 %	0.05 %
	C/CT	3.00 %	-	3.00 %	-	-	-	-	2.10 %	0.05 %
	F/FT	-	-	-	-	-	-	-	1.06 %	0.01 %
	I/IT	-	-	-	-	-	-	-	0.79 %	0.01 %
	N/NT	-	-	-	-	-	-	-	1.06 %	0.05 %
	P/PT	-	-	-	-	-	-	-	0.79 %	0.05 %
	R/RT	-	-	-	-	-	-	-	1.10 %	0.05 %
	S/ST	5.00 %	-	5.00 %	-	-	-	-	1.26 %	0.05 %
	W/WT	-	-	-	-	-	-	-	0.49 %	0.01 %
	X/XT	-	-	-	-	-	-	-	1.06 %	0.01 %
Allianz Euro High Yield Defensive	A/AT	5.00 %	-	5.00 %	-	-	-	-	1.35 %	0.05 %
	C/CT	5.00 %	-	5.00 %	-	-	-	-	1.60 %	0.05 %
	I/IT	-	-	-	-	-	-	-	0.79 %	0.01 %
	N/NT	-	-	-	-	-	-	-	1.06 %	0.05 %
	P/PT	2.00 %	-	2.00 %	-	-	-	-	1.06 %	0.05 %
	R/RT	-	-	-	-	-	-	-	1.15 %	0.05 %
	W/WT	-	-	-	-	-	-	-	1.06 %	0.01 %
	X/XT	-	-	-	-	-	-	-	1.06 %	0.01 %
	Y/YT	-	-	-	-	-	-	-	0.79 %	0.05 %

Sub-Fund Name	Share Class	Sales Charge	Placement Fee	Conversion Fee	Redemption Fee	Disinvestment Fee	Exit Fee	CDSC	All-in-Fee (p.a.)	Taxe d' Abonnement (p.a.)
Allianz Euro Inflation-linked Bond	A/AT	5.00 %	-	5.00 %	-	-	-	-	1.40 %	0.05 %
	C/CT	5.00 %	-	5.00 %	-	-	-	-	2.15 %	0.05 %
	F/FT	-	-	-	-	-	-	-	0.99 %	0.01 %
	I/IT	5.00 %	-	5.00 %	-	-	-	-	0.99 %	0.01 %
	N/NT	-	-	-	-	-	-	-	0.99 %	0.05 %
	P/PT	2.00 %	-	2.00 %	-	-	-	-	0.99 %	0.05 %
	R/RT	-	-	-	-	-	-	-	1.20 %	0.05 %
	S/ST	6.00 %	-	6.00 %	-	-	-	-	1.20 %	0.05 %
	W/WT	-	-	-	-	-	-	-	0.41 %	0.01 %
	X/XT	-	-	-	-	-	-	-	0.99 %	0.01 %
Y/YT	-	-	-	-	-	-	-	0.99 %	0.05 %	
Allianz Euroland Equity Growth	A/AT	5.00 %	-	5.00 %	-	-	-	-	1.80 %	0.05 %
	C/CT	5.00 %	-	5.00 %	-	-	-	-	2.55 %	0.05 %
	F/FT	-	-	-	-	-	-	-	1.38 %	0.01 %
	I/IT	2.00 %	-	2.00 %	-	-	-	-	0.95 %	0.01 %
	N/NT	-	-	-	-	-	-	-	1.38 %	0.05 %
	P/PT	2.00 %	-	2.00 %	-	-	-	-	1.38 %	0.05 %
	R/RT	-	-	-	-	-	-	-	1.45 %	0.05 %
	S/ST	7.00 %	-	7.00 %	-	-	-	-	1.65 %	0.05 %
	W/WT	-	-	-	-	-	-	-	0.65 %	0.01 %
	X/XT	-	-	-	-	-	-	-	1.38 %	0.01 %
Y/YT	-	-	-	-	-	-	-	0.95 %	0.05 %	
Allianz Europe Equity Growth	A/AT	5.00 %	-	5.00 %	-	-	-	-	1.80 %	0.05 %
	C/CT	5.00 %	-	5.00 %	-	-	-	-	2.55 %	0.05 %
	I/IT	2.00 %	-	2.00 %	-	-	-	-	0.95 %	0.01 %
	N/NT	-	-	-	-	-	-	-	1.38 %	0.05 %
	P/PT	2.00 %	-	2.00 %	-	-	-	-	0.95 %	0.05 %
	P2 (EUR)	2.00 %	-	2.00 %	-	-	-	-	0.65 %	0.05 %
	P8/PT8/P9/PT9	2.00 %	-	2.00 %	-	-	-	-	1.10 %	0.05 %
	R/RT	-	-	-	-	-	-	-	1.45 %	0.05 %
	S/ST	7.00 %	-	7.00 %	-	-	-	-	1.65 %	0.05 %
	W/WT	-	-	-	-	-	-	-	0.65 %	0.01 %
X/XT	-	-	-	-	-	-	-	1.38 %	0.01 %	
Y/YT	-	-	-	-	-	-	-	0.95 %	0.05 %	
Allianz Europe Equity Growth Select	A/AT	5.00 %	-	5.00 %	-	-	-	-	1.80 %	0.05 %
	C/CT	5.00 %	-	5.00 %	-	-	-	-	2.55 %	0.05 %
	E/ET	-	-	-	-	-	-	-	1.65 %	0.05 %
	I/IT	2.00 %	-	2.00 %	-	-	-	-	0.95 %	0.01 %
	N/NT	-	-	-	-	-	-	-	1.38 %	0.05 %
	P/PT	2.00 %	-	2.00 %	-	-	-	-	0.95 %	0.05 %
	P8/PT8/P9/PT9	2.00 %	-	2.00 %	-	-	-	-	1.10 %	0.05 %
	R/RT	-	-	-	-	-	-	-	1.45 %	0.05 %
	S/ST	6.00 %	-	6.00 %	-	-	-	-	1.50 %	0.05 %
	W/WT	-	-	-	-	-	-	-	0.65 %	0.01 %
X/XT	-	-	-	-	-	-	-	1.38 %	0.01 %	
Y/YT	-	-	-	-	-	-	-	0.95 %	0.05 %	
Allianz Europe Equity powered by Artificial Intelligence	A/AT	5.00 %	-	5.00 %	-	-	-	-	1.60 %	0.05 %
	C/CT	5.00 %	-	5.00 %	-	-	-	-	2.25 %	0.05 %
	E/ET	-	-	-	-	-	-	-	1.60 %	0.05 %
	I/IT	2.00 %	-	2.00 %	-	-	-	-	1.20 %	0.01 %
	P/PT	2.00 %	-	2.00 %	-	-	-	-	1.20 %	0.05 %
	R/RT	-	-	-	-	-	-	-	1.30 %	0.05 %
	W/WT	-	-	-	-	-	-	-	0.80 %	0.01 %
	X/XT	-	-	-	-	-	-	-	0.80 %	0.01 %
Y/YT	-	-	-	-	-	-	-	0.80 %	0.05 %	

- Allianz Global Investors Fund -

Sub-Fund Name	Share Class	Sales Charge	Placement Fee	Conversion Fee	Redemption Fee	Disinvestment Fee	Exit Fee	CDSC	All-in-Fee (p.a.)	Taxe d' Abonnement (p.a.)
Allianz Europe Equity SRI	A/AT	5.00 %	-	5.00 %	-	-	-	-	1.80 %	0.05 %
	C/CT	5.00 %	-	5.00 %	-	-	-	-	2.55 %	0.05 %
	I/IT	2.00 %	-	2.00 %	-	-	-	-	1.38 %	0.01 %
	N/NT	-	-	-	-	-	-	-	1.38 %	0.05 %
	P/PT	2.00 %	-	2.00 %	-	-	-	-	1.38 %	0.05 %
	R/RT	-	-	-	-	-	-	-	1.45 %	0.05 %
	S/ST	7.00 %	-	7.00 %	-	-	-	-	1.65 %	0.05 %
	W/WT	-	-	-	-	-	-	-	0.65 %	0.01 %
	X/XT	-	-	-	-	-	-	-	1.38 %	0.01 %
Y/YT	-	-	-	-	-	-	-	1.38 %	0.05 %	
Allianz Europe Equity Value	A/AT	5.00 %	-	5.00 %	-	-	-	-	1.80 %	0.05 %
	C/CT	6.00 %	-	6.00 %	-	-	-	-	2.40 %	0.05 %
	I/IT	2.00 %	-	2.00 %	-	-	-	-	0.95 %	0.01 %
	N/NT	-	-	-	-	-	-	-	1.75 %	0.05 %
	P/PT	2.00 %	-	2.00 %	-	-	-	-	1.75 %	0.05 %
	R/RT	-	-	-	-	-	-	-	1.75 %	0.05 %
	S/ST	7.00 %	-	7.00 %	-	-	-	-	1.75 %	0.05 %
	W/WT	-	-	-	-	-	-	-	1.75 %	0.01 %
	X/XT	-	-	-	-	-	-	-	1.75 %	0.01 %
Y/YT	-	-	-	-	-	-	-	0.88 %	0.05 %	
Allianz Europe Income and Growth	A/AT	5.00 %	-	5.00 %	-	-	-	-	1.50 %	0.05 %
	C/CT	5.00 %	-	5.00 %	-	-	-	-	2.25 %	0.05 %
	I/IT	2.00 %	-	2.00 %	-	-	-	-	0.84 %	0.01 %
	N/NT	-	-	-	-	-	-	-	1.15 %	0.05 %
	P/PT	2.00 %	-	2.00 %	-	-	-	-	0.84 %	0.05 %
	R/RT	-	-	-	-	-	-	-	1.20 %	0.05 %
	S/ST	7.00 %	-	7.00 %	-	-	-	-	1.38 %	0.05 %
	W/WT	-	-	-	-	-	-	-	1.15 %	0.01 %
	X/XT	-	-	-	-	-	-	-	1.15 %	0.01 %
Y/YT	-	-	-	-	-	-	-	0.84 %	0.05 %	
Allianz Europe Mid Cap Equity	A/AT	5.00 %	-	5.00 %	-	-	-	-	2.50 %	0.05 %
	C/CT	5.00 %	-	5.00 %	-	-	-	-	3.00 %	0.05 %
	I/IT	2.00 %	-	2.00 %	-	-	-	-	1.08 %	0.01 %
	N/NT	-	-	-	-	-	-	-	1.50 %	0.05 %
	P/PT	2.00 %	-	2.00 %	-	-	-	-	1.50 %	0.05 %
	R/RT	-	-	-	-	-	-	-	1.60 %	0.05 %
	S/ST	7.00 %	-	7.00 %	-	-	-	-	1.50 %	0.05 %
	W/WT	-	-	-	-	-	-	-	1.50 %	0.01 %
	X/XT	-	-	-	-	-	-	-	1.50 %	0.01 %
Y/YT	-	-	-	-	-	-	-	1.08 %	0.05 %	
Allianz Europe Small and Micro Cap Equity	A/AT	5.00 %	-	5.00 %	-	-	-	-	2.10 %	0.05 %
	C/CT	5.00 %	-	5.00 %	-	-	-	-	2.85 %	0.05 %
	I/IT	2.00 %	-	2.00 %	-	-	-	-	1.25 %	0.01 %
	N/NT	-	-	-	-	-	-	-	1.25 %	0.05 %
	P/PT	2.00 %	-	2.00 %	-	-	-	-	1.25 %	0.05 %
	R/RT	-	-	-	-	-	-	-	1.35 %	0.05 %
	S/ST	7.00 %	-	7.00 %	-	-	-	-	0.95 %	0.05 %
	W/WT	-	-	-	-	-	-	-	0.95 %	0.01 %
	X/XT	-	-	-	-	-	-	-	0.95 %	0.01 %
Y/YT	-	-	-	-	-	-	-	0.95 %	0.05 %	
Allianz Europe Small Cap Equity	A/AT	5.00 %	-	5.00 %	-	-	-	-	2.05 %	0.05 %
	C/CT	5.00 %	-	5.00 %	-	-	-	-	2.80 %	0.05 %
	I/IT	2.00 %	-	2.00 %	-	-	-	-	1.08 %	0.01 %
	N/NT	-	-	-	-	-	-	-	1.53 %	0.05 %
	P/PT	2.00 %	-	2.00 %	-	-	-	-	1.08 %	0.05 %
	R/RT	-	-	-	-	-	-	-	1.60 %	0.05 %
	S/ST	7.00 %	-	7.00 %	-	-	-	-	1.75 %	0.05 %
	W/WT	-	-	-	-	-	-	-	0.73 %	0.01 %
	X/XT	-	-	-	-	-	-	-	1.53 %	0.01 %
Y/YT	-	-	-	-	-	-	-	1.08 %	0.05 %	

- Allianz Global Investors Fund -

Sub-Fund Name	Share Class	Sales Charge	Placement Fee	Conversion Fee	Redemption Fee	Disinvestment Fee	Exit Fee	CDSC	All-in-Fee (p.a.)	Taxe d' Abonnement (p.a.)
Allianz European Bond RC	A/AT	2.00 %	-	2.00 %	-	-	-	-	1.10 %	0.05 %
	C/CT	2.00 %	-	2.00 %	-	-	-	-	1.85 %	0.05 %
	I/IT	1.00 %	-	1.00 %	-	-	-	-	0.76 %	0.01 %
	N/NT	-	-	-	-	-	-	-	0.63 %	0.05 %
	P/PT	1.00 %	-	1.00 %	-	-	-	-	0.76 %	0.05 %
	R/RT	-	-	-	-	-	-	-	0.80 %	0.05 %
	S/ST	2.00 %	-	2.00 %	-	-	-	-	0.80 %	0.05 %
	W/WT	-	-	-	-	-	-	-	0.63 %	0.01 %
	X/XT	-	-	-	-	-	-	-	0.57 %	0.01 %
Y/YT	4.00 %	-	4.00 %	-	-	-	-	0.61 %	0.05 %	
Allianz European Equity Dividend	A/AT	5.00 %	-	5.00 %	-	-	-	-	1.80 %	0.05 %
	B/BT	-	-	5.00 %	-	-	-	3.00 %	2.80 %	0.05 %
	C/CT	5.00 %	-	5.00 %	-	-	-	-	2.55 %	0.05 %
	E/ET	-	-	-	-	-	-	-	1.65 %	0.05 %
	F/FT	-	-	-	-	-	-	-	1.38 %	0.01 %
	I/IT	2.00 %	-	2.00 %	-	-	-	-	0.95 %	0.01 %
	N/NT	-	-	-	-	-	-	-	1.38 %	0.05 %
	P/PT	2.00 %	-	2.00 %	-	-	-	-	0.95 %	0.05 %
	P8/PT8/P9/PT9	2.00 %	-	2.00 %	-	-	-	-	1.10 %	0.05 %
	R/RT	-	-	-	-	-	-	-	1.45 %	0.05 %
	S/ST	7.00 %	-	7.00 %	-	-	-	-	1.65 %	0.05 %
	W/WT	-	-	-	-	-	-	-	0.65 %	0.01 %
	X/XT	-	-	-	-	-	-	-	1.38 %	0.01 %
Y/YT	-	-	-	-	-	-	-	0.95 %	0.05 %	
Allianz Fixed Income Macro	I/IT	2.00 %	-	2.00 %	-	-	-	-	1.70 %	0.01 %
	N/NT	-	-	-	-	-	-	-	1.70 %	0.05 %
	P/PT	2.00 %	-	2.00 %	-	-	-	-	1.70 %	0.05 %
	R2/RT2	-	-	-	-	-	-	-	1.70 %	0.05 %
	W/WT	-	-	-	-	-	-	-	1.70 %	0.01 %
	X/XT	-	-	-	-	-	-	-	1.70 %	0.01 %
	Y/YT	-	-	-	-	-	-	-	1.70 %	0.05 %
Allianz Flexi Asia Bond	A/AT	5.00 %	-	5.00 %	-	-	-	-	1.50 %	0.05 %
	B/BT	-	-	5.00 %	-	-	-	3.00 %	2.50 %	0.05 %
	C/CT	5.00 %	-	5.00 %	-	-	-	-	2.25 %	0.05 %
	I/IT	2.00 %	-	2.00 %	-	-	-	-	0.82 %	0.01 %
	N/NT	-	-	-	-	-	-	-	1.15 %	0.05 %
	P/PT	2.00 %	-	2.00 %	-	-	-	-	0.82 %	0.05 %
	P8/PT8	2.00 %	-	2.00 %	-	-	-	-	0.95 %	0.05 %
	R/RT	-	-	-	-	-	-	-	1.20 %	0.05 %
	S/ST	7.00 %	-	7.00 %	-	-	-	-	1.38 %	0.05 %
	W/WT	-	-	-	-	-	-	-	1.15 %	0.01 %
	X/XT	-	-	-	-	-	-	-	1.15 %	0.01 %
Y/YT	-	-	-	-	-	-	-	0.82 %	0.05 %	
Allianz Floating Rate Notes Plus ¹⁾	A/AT	2.00 %	-	2.00 %	-	-	-	-	0.45 %	0.05 %
	C/CT	-	-	-	-	-	-	-	1.20 %	0.05 %
	F/FT	-	-	-	-	-	-	-	0.35 %	0.01 %
	I/IT	-	-	-	-	-	-	-	0.35 %	0.01 %
	N/NT	-	-	-	-	-	-	-	0.35 %	0.05 %
	P/PT	2.00 %	-	2.00 %	-	-	-	-	0.35 %	0.05 %
	R/RT	-	-	-	-	-	-	-	0.45 %	0.05 %
	S/ST	-	-	-	-	-	-	-	0.35 %	0.05 %
	W/WT	-	-	-	-	-	-	-	0.35 %	0.01 %
	X/XT	-	-	-	-	-	-	-	1.00 %	0.01 %
	Y/YT	-	-	-	-	-	-	-	0.35 %	0.05 %
Allianz Food Security	A/AT	5.00 %	-	5.00 %	-	-	-	-	2.35 %	0.05 %
	C/CT	-	-	-	-	-	-	-	3.10 %	0.05 %
	I/IT	2.00 %	-	2.00 %	-	-	-	-	1.38 %	0.01 %
	P/PT	-	-	-	-	-	-	-	1.38 %	0.05 %
	R/RT	-	-	-	-	-	-	-	1.48 %	0.05 %
	W/WT	-	-	-	-	-	-	-	1.03 %	0.01 %
	X/XT	-	-	-	-	-	-	-	1.38 %	0.01 %
Y/YT	-	-	-	-	-	-	-	0.92 %	0.05 %	

- Allianz Global Investors Fund -

Sub-Fund Name	Share Class	Sales Charge	Placement Fee	Conversion Fee	Redemption Fee	Disinvestment Fee	Exit Fee	CDSC	All-in-Fee (p.a.)	Taxe d' Abonnement (p.a.)
Allianz GEM Equity High Dividend	A/AT	5.00 %	-	5.00 %	-	-	-	-	2.25 %	0.05 %
	C/CT	5.00 %	-	5.00 %	-	-	-	-	3.00 %	0.05 %
	I/IT	2.00 %	-	2.00 %	-	-	-	-	1.28 %	0.01 %
	N/NT	-	-	-	-	-	-	-	1.85 %	0.05 %
	P/PT	2.00 %	-	2.00 %	-	-	-	-	1.85 %	0.05 %
	R/RT	-	-	-	-	-	-	-	2.20 %	0.05 %
	S/ST	7.00 %	-	7.00 %	-	-	-	-	1.85 %	0.05 %
	W/WT	-	-	-	-	-	-	-	1.85 %	0.01 %
	X/XT	-	-	-	-	-	-	-	1.85 %	0.01 %
Y/YT	-	-	-	-	-	-	-	1.28 %	0.05 %	
Allianz German Equity	A/AT	5.00 %	-	5.00 %	-	-	-	-	1.80 %	0.05 %
	C/CT	5.00 %	-	5.00 %	-	-	-	-	2.55 %	0.05 %
	F/FT	-	-	-	-	-	-	-	0.45 %	0.01 %
	I/IT	2.00 %	-	2.00 %	-	-	-	-	0.95 %	0.01 %
	N/NT	-	-	-	-	-	-	-	1.38 %	0.05 %
	P/PT	2.00 %	-	2.00 %	-	-	-	-	0.95 %	0.05 %
	R/RT	-	-	-	-	-	-	-	1.45 %	0.05 %
	S/ST	6.00 %	-	6.00 %	-	-	-	-	1.50 %	0.05 %
	W/WT	-	-	-	-	-	-	-	0.65 %	0.01 %
X/XT	-	-	-	-	-	-	-	1.38 %	0.01 %	
Y/YT	-	-	-	-	-	-	-	0.95 %	0.05 %	
Allianz German Small and Micro Cap	A/AT	5.00 %	-	5.00 %	-	-	-	-	3.60 %	0.05 %
	C/CT	5.00 %	-	5.00 %	-	-	-	-	4.35 %	0.05 %
	I/IT	2.00 %	-	2.00 %	-	-	-	-	2.75 %	0.01 %
	N/NT	-	-	-	-	-	-	-	2.45 %	0.05 %
	P/PT	2.00 %	-	2.00 %	-	-	-	-	2.75 %	0.05 %
	R/RT	-	-	-	-	-	-	-	2.85 %	0.05 %
	S/ST	6.00 %	-	6.00 %	-	-	-	-	2.85 %	0.05 %
	W/WT	-	-	-	-	-	-	-	2.45 %	0.01 %
	X/XT	-	-	-	-	-	-	-	2.30 %	0.01 %
Y/YT	-	-	-	-	-	-	-	2.36 %	0.05 %	
Allianz Global Aggregate Bond	A/AT	5.00 %	-	5.00 %	-	-	-	-	1.50 %	0.05 %
	C/CT	5.00 %	-	5.00 %	-	-	-	-	2.25 %	0.05 %
	I/IT	2.00 %	-	2.00 %	-	-	-	-	1.10 %	0.01 %
	P/PT	2.00 %	-	2.00 %	-	-	-	-	1.10 %	0.05 %
	R/RT	-	-	-	-	-	-	-	1.30 %	0.05 %
	W/WT	-	-	-	-	-	-	-	1.10 %	0.01 %
	X/XT	-	-	-	-	-	-	-	1.10 %	0.01 %
	Y/YT	-	-	-	-	-	-	-	0.57 %	0.05 %
	Allianz Global Artificial Intelligence	A/AT	5.00 %	-	5.00 %	-	-	-	-	2.05 %
B/BT		-	-	5.00 %	-	-	-	3.00 %	3.05 %	0.05 %
C/CT		5.00 %	-	5.00 %	-	-	-	-	2.80 %	0.05 %
E/ET		-	-	-	-	-	-	-	1.65 %	0.05 %
I/IT		2.00 %	-	2.00 %	-	-	-	-	1.50 %	0.01 %
N/NT		-	-	-	-	-	-	-	1.50 %	0.05 %
P/PT		2.00 %	-	2.00 %	-	-	-	-	1.50 %	0.05 %
R/RT		-	-	-	-	-	-	-	1.60 %	0.05 %
S/ST		7.00 %	-	7.00 %	-	-	-	-	1.50 %	0.05 %
W/WT	-	-	-	-	-	-	-	1.50 %	0.01 %	
X/XT	-	-	-	-	-	-	-	1.50 %	0.01 %	
Y/YT	-	-	-	-	-	-	-	1.50 %	0.05 %	
Allianz Global Capital Plus	A/AT	-	2.50 %	-	-	-	2.50 %	-	1.65 %	0.05 %
	C/CT	-	2.50 %	-	-	-	2.50 %	-	2.40 %	0.05 %
	I/IT	-	2.50 %	-	-	-	2.50 %	-	1.10 %	0.01 %
	N/NT	-	2.50 %	-	-	-	2.50 %	-	1.10 %	0.05 %
	P/PT	-	2.50 %	-	-	-	2.50 %	-	1.10 %	0.05 %
	R/RT	-	2.50 %	-	-	-	2.50 %	-	1.30 %	0.05 %
	S/ST	-	2.50 %	-	-	-	2.50 %	-	1.10 %	0.05 %
	W/WT	-	2.50 %	-	-	-	2.50 %	-	1.10 %	0.01 %
	X/XT	-	2.50 %	-	-	-	2.50 %	-	1.00 %	0.01 %
Y/YT	-	2.50 %	-	-	-	2.50 %	-	1.10 %	0.05 %	

- Allianz Global Investors Fund -

Sub-Fund Name	Share Class	Sales Charge	Placement Fee	Conversion Fee	Redemption Fee	Disinvestment Fee	Exit Fee	CDSC	All-in-Fee (p.a.)	Taxe d' Abonnement (p.a.)
Allianz Global Credit SRI	A/AT	3.00 %	-	3.00 %	-	-	-	-	1.15 %	0.05 %
	B/BT	-	-	3.00 %	-	-	-	3.00 %	2.15 %	0.05 %
	C/CT	3.00 %	-	3.00 %	-	-	-	-	1.90 %	0.05 %
	E/ET	-	-	-	-	-	-	-	0.85 %	0.05 %
	I/IT	2.00 %	-	2.00 %	-	-	-	-	0.75 %	0.01 %
	N/NT	-	-	-	-	-	-	-	0.75 %	0.05 %
	P/PT	-	-	-	-	-	-	-	0.75 %	0.05 %
	R/RT	-	-	-	-	-	-	-	0.90 %	0.05 %
	W/WT	-	-	-	-	-	-	-	0.75 %	0.01 %
	X/XT	-	-	-	-	-	-	-	0.65 %	0.01 %
Y/YT	-	-	-	-	-	-	-	0.75 %	0.05 %	
Allianz Global Diversified Dividend	A/AT	5.00 %	-	5.00 %	-	-	-	-	1.60 %	0.05 %
	C/CT	5.00 %	-	5.00 %	-	-	-	-	2.25 %	0.05 %
	E/ET	-	-	-	-	-	-	-	1.60 %	0.05 %
	I/IT	2.00 %	-	2.00 %	-	-	-	-	1.20 %	0.01 %
	P/PT	2.00 %	-	2.00 %	-	-	-	-	1.20 %	0.05 %
	R/RT	-	-	-	-	-	-	-	1.30 %	0.05 %
	W/WT	-	-	-	-	-	-	-	0.80 %	0.01 %
	X/XT	-	-	-	-	-	-	-	0.80 %	0.01 %
	Y/YT	-	-	-	-	-	-	-	0.80 %	0.05 %
Allianz Global Dividend	A/AT	5.00 %	-	5.00 %	-	-	-	-	1.80 %	0.05 %
	B/BT	-	-	5.00 %	-	-	-	3.00 %	2.80 %	0.05 %
	C/CT	5.00 %	-	5.00 %	-	-	-	-	3.00 %	0.05 %
	F/FT	-	-	-	-	-	-	-	1.50 %	0.01 %
	I/IT	2.00 %	-	2.00 %	-	-	-	-	1.50 %	0.01 %
	N/NT	-	-	-	-	-	-	-	1.50 %	0.05 %
	P/PT	2.00 %	-	2.00 %	-	-	-	-	1.50 %	0.05 %
	R/RT	-	-	-	-	-	-	-	1.50 %	0.05 %
	W/WT	-	-	-	-	-	-	-	1.50 %	0.01 %
	X/XT	-	-	-	-	-	-	-	1.50 %	0.01 %
	Y/YT	-	-	-	-	-	-	-	1.50 %	0.05 %
Allianz Global Dynamic Multi Asset Income	A/AT	5.00 %	-	5.00 %	-	-	-	-	1.45 %	0.05 %
	C/CT	5.00 %	-	5.00 %	-	-	-	-	2.20 %	0.05 %
	I/IT	2.00 %	-	2.00 %	-	-	-	-	0.79 %	0.01 %
	N/NT	-	-	-	-	-	-	-	0.55 %	0.05 %
	P/PT	2.00 %	-	2.00 %	-	-	-	-	0.79 %	0.05 %
	R/RT	-	-	-	-	-	-	-	0.85 %	0.05 %
	S/ST	7.00 %	-	7.00 %	-	-	-	-	0.85 %	0.05 %
	W/WT	-	-	-	-	-	-	-	0.55 %	0.01 %
	X/XT	-	-	-	-	-	-	-	0.43 %	0.01 %
Y/YT	-	-	-	-	-	-	-	0.79 %	0.05 %	
Allianz Global Emerging Markets Equity Dividend	A/AT	5.00 %	-	5.00 %	-	-	-	-	2.25 %	0.05 %
	C/CT	5.00 %	-	5.00 %	-	-	-	-	3.00 %	0.05 %
	I/IT	-	-	-	-	-	-	-	1.28 %	0.01 %
	N/NT	-	-	-	-	-	-	-	1.28 %	0.05 %
	P/PT	-	-	-	-	-	-	-	1.28 %	0.05 %
	R/RT	-	-	-	-	-	-	-	1.38 %	0.05 %
	S/ST	7.00 %	-	7.00 %	-	-	-	-	1.38 %	0.05 %
	W/WT	-	-	-	-	-	-	-	1.28 %	0.01 %
	X/XT	-	-	-	-	-	-	-	1.28 %	0.01 %
Y/YT	-	-	-	-	-	-	-	1.28 %	0.05 %	
Allianz Global Equity Growth	A/AT	5.00 %	-	5.00 %	-	-	-	-	1.80 %	0.05 %
	B/BT	-	-	5.00 %	-	-	-	3.00 %	2.80 %	0.05 %
	C/CT	5.00 %	-	5.00 %	-	-	-	-	2.55 %	0.05 %
	E/ET	-	-	-	-	-	-	-	1.65 %	0.05 %
	I/IT	2.00 %	-	2.00 %	-	-	-	-	0.95 %	0.01 %
	P/PT	-	-	-	-	-	-	-	0.95 %	0.05 %
	R/RT	-	-	-	-	-	-	-	1.45 %	0.05 %
	W/WT	-	-	-	-	-	-	-	0.65 %	0.01 %
	X/XT	-	-	-	-	-	-	-	0.95 %	0.01 %
Y/YT	-	-	-	-	-	-	-	0.95 %	0.05 %	

- Allianz Global Investors Fund -

Sub-Fund Name	Share Class	Sales Charge	Placement Fee	Conversion Fee	Redemption Fee	Disinvestment Fee	Exit Fee	CDSC	All-in-Fee (p.a.)	Taxe d' Abonnement (p.a.)
Allianz Global Equity Insights	A/AT	5.00 %	-	5.00 %	-	-	-	-	2.05 %	0.05 %
	B/BT	-	-	5.00 %	-	-	-	3.00 %	3.05 %	0.05 %
	C/CT	5.00 %	-	5.00 %	-	-	-	-	2.80 %	0.05 %
	E/ET	-	-	-	-	-	-	-	1.65 %	0.05 %
	I/IT	2.00 %	-	2.00 %	-	-	-	-	1.50 %	0.01 %
	N/NT	-	-	-	-	-	-	-	1.50 %	0.05 %
	P/PT	2.00 %	-	2.00 %	-	-	-	-	1.50 %	0.05 %
	R/RT	-	-	-	-	-	-	-	1.60 %	0.05 %
	S/ST	7.00 %	-	7.00 %	-	-	-	-	1.50 %	0.05 %
	W/WT	-	-	-	-	-	-	-	1.50 %	0.01 %
Allianz Global Equity powered by Artificial Intelligence	A/AT	5.00 %	-	5.00 %	-	-	-	-	1.60 %	0.05 %
	C/CT	5.00 %	-	5.00 %	-	-	-	-	2.25 %	0.05 %
	E/ET	-	-	-	-	-	-	-	1.60 %	0.05 %
	I/IT	2.00 %	-	2.00 %	-	-	-	-	1.20 %	0.01 %
	P/PT	2.00 %	-	2.00 %	-	-	-	-	1.20 %	0.05 %
	R/RT	-	-	-	-	-	-	-	1.30 %	0.05 %
	W/WT	-	-	-	-	-	-	-	0.80 %	0.01 %
	X/XT	-	-	-	-	-	-	-	0.80 %	0.01 %
	Y/YT	-	-	-	-	-	-	-	0.80 %	0.05 %
	Allianz Global Equity Unconstrained	A/AT	5.00 %	-	5.00 %	-	-	-	-	2.05 %
B/BT		-	-	5.00 %	-	-	-	3.00 %	3.05 %	0.05 %
C/CT		5.00 %	-	5.00 %	-	-	-	-	2.80 %	0.05 %
I/IT		2.00 %	-	2.00 %	-	-	-	-	1.50 %	0.01 %
N/NT		-	-	-	-	-	-	-	1.50 %	0.05 %
P/PT		2.00 %	-	2.00 %	-	-	-	-	1.50 %	0.05 %
R/RT		-	-	-	-	-	-	-	1.60 %	0.05 %
S/ST		7.00 %	-	7.00 %	-	-	-	-	1.50 %	0.05 %
W/WT		-	-	-	-	-	-	-	0.73 %	0.01 %
X/XT		-	-	-	-	-	-	-	1.50 %	0.01 %
Allianz Global Floating Rate Notes Plus	A/AT	5.00 %	-	5.00 %	-	-	-	-	0.90 %	0.05 %
	C/CT	5.00 %	-	5.00 %	-	-	-	-	1.65 %	0.05 %
	C2/CT2/C3/CT3	-	-	1.00 %	1.00 %	-	-	-	0.90 %	0.05 %
	I/IT	2.00 %	-	2.00 %	-	-	-	-	0.60 %	0.01 %
	N/NT	-	-	-	-	-	-	-	0.50 %	0.05 %
	P/PT	2.00 %	-	2.00 %	-	-	-	-	0.60 %	0.05 %
	R/RT	-	-	-	-	-	-	-	0.65 %	0.05 %
	S/ST	7.00 %	-	7.00 %	-	-	-	-	0.65 %	0.05 %
	W/WT	-	-	-	-	-	-	-	0.50 %	0.01 %
	X/XT	-	-	-	-	-	-	-	0.45 %	0.05 %
Allianz Global Government Bond	A/AT	5.00 %	-	5.00 %	-	-	-	-	1.20 %	0.05 %
	C/CT	5.00 %	-	5.00 %	-	-	-	-	1.95 %	0.05 %
	F/FT	-	-	-	-	-	-	-	0.25 %	0.01 %
	I/IT	2.00 %	-	2.00 %	-	-	-	-	1.10 %	0.01 %
	P/PT	2.00 %	-	2.00 %	-	-	-	-	1.10 %	0.05 %
	R/RT	-	-	-	-	-	-	-	1.30 %	0.05 %
	W/WT	-	-	-	-	-	-	-	1.10 %	0.01 %
	X/XT	-	-	-	-	-	-	-	1.10 %	0.01 %
	Y/YT	-	-	-	-	-	-	-	0.55 %	0.05 %
	Allianz Global High Yield	A/AT	3.00 %	-	3.00 %	-	-	-	-	1.45 %
B/BT		-	-	3.00 %	-	-	-	3.00 %	2.45 %	0.05 %
C/CT		3.00 %	-	3.00 %	-	-	-	-	2.20 %	0.05 %
C2/CT2/C3/CT3		-	-	1.00 %	1.00 %	-	-	-	1.45 %	0.05 %
I/IT		2.00 %	-	2.00 %	-	-	-	-	1.10 %	0.01 %
N/NT		-	-	-	-	-	-	-	1.10 %	0.05 %
P/PT		-	-	-	-	-	-	-	1.10 %	0.05 %
R/RT		-	-	-	-	-	-	-	1.20 %	0.05 %
W/WT		-	-	-	-	-	-	-	1.10 %	0.01 %
X/XT		-	-	-	-	-	-	-	0.90 %	0.01 %
Y/YT	-	-	-	-	-	-	-	1.10 %	0.05 %	

- Allianz Global Investors Fund -

Sub-Fund Name	Share Class	Sales Charge	Placement Fee	Conversion Fee	Redemption Fee	Disinvestment Fee	Exit Fee	CDSC	All-in-Fee (p.a.)	Taxe d' Abonnement (p.a.)
Allianz Global Hi-Tech Growth	A/AT	5.00 %	-	5.00 %	-	-	-	-	2.05 %	0.05 %
	C/CT	5.00 %	-	5.00 %	-	-	-	-	2.80 %	0.05 %
	F/FT	-	-	-	-	-	-	-	0.53 %	0.01 %
	I/IT	-	-	-	-	-	-	-	1.53 %	0.01 %
	N/NT	-	-	-	-	-	-	-	1.53 %	0.05 %
	P/PT	-	-	-	-	-	-	-	1.53 %	0.05 %
	R/RT	-	-	-	-	-	-	-	1.60 %	0.05 %
	S/ST	7.00 %	-	7.00 %	-	-	-	-	1.84 %	0.05 %
	W/WT	-	-	-	-	-	-	-	1.53 %	0.01 %
	X/XT	-	-	-	-	-	-	-	1.53 %	0.01 %
Y/YT	-	-	-	-	-	-	-	1.53 %	0.05 %	
Allianz Global Income	A/AT	5.00 %	-	5.00 %	-	-	-	-	1.90 %	0.05 %
	B/BT	-	-	5.00 %	-	-	-	3.00 %	2.90 %	0.05 %
	C/CT	5.00 %	-	5.00 %	-	-	-	-	3.40 %	0.05 %
	I/IT	2.00 %	-	2.00 %	-	-	-	-	1.14 %	0.01 %
	N/NT	-	-	-	-	-	-	-	0.86 %	0.05 %
	P/PT	2.00 %	-	2.00 %	-	-	-	-	1.14 %	0.05 %
	R/RT	-	-	-	-	-	-	-	1.20 %	0.05 %
	S/ST	-	-	-	-	-	-	-	1.20 %	0.05 %
	W/WT	-	-	-	-	-	-	-	0.86 %	0.01 %
	X/XT	-	-	-	-	-	-	-	0.72 %	0.01 %
Y/YT	-	-	-	-	-	-	-	0.78 %	0.05 %	
Allianz Global Inflation-Linked Bond	A/AT	5.00 %	-	5.00 %	-	-	-	-	1.19 %	0.05 %
	C/CT	5.00 %	-	5.00 %	-	-	-	-	1.19 %	0.05 %
	I/IT	2.00 %	-	2.00 %	-	-	-	-	0.75 %	0.01 %
	N/NT	-	-	-	-	-	-	-	0.59 %	0.05 %
	P/PT	2.00 %	-	2.00 %	-	-	-	-	0.75 %	0.05 %
	R/RT	-	-	-	-	-	-	-	0.79 %	0.05 %
	S/ST	-	-	-	-	-	-	-	0.79 %	0.05 %
	W/WT	-	-	-	-	-	-	-	0.59 %	0.01 %
	X/XT	-	-	-	-	-	-	-	0.51 %	0.01 %
	Y/YT	2.00 %	-	2.00 %	-	-	-	-	0.75 %	0.05 %
Allianz Global Intelligent Cities Income	A/AT	5.00 %	-	5.00 %	-	-	-	-	1.90 %	0.05 %
	C/CT	-	-	-	-	-	-	-	1.90 %	0.05 %
	C6/CT6	-	2.50 %	-	-	-	2.50 %	-	1.90 %	0.05 %
	B/BT	-	-	5.00 %	-	-	-	3.00 %	2.90 %	0.05 %
	I/IT	2.00 %	-	2.00 %	-	-	-	-	1.14 %	0.01 %
	P/PT	-	-	-	-	-	-	-	1.14 %	0.05 %
	R/RT	-	-	-	-	-	-	-	1.20 %	0.05 %
	W/WT	-	-	-	-	-	-	-	0.86 %	0.01 %
	W6/WT6	-	2.50 %	-	-	-	2.50 %	-	0.86 %	0.01 %
	X/XT	-	-	-	-	-	-	-	0.44 %	0.01 %
Allianz Global Metals and Mining	A/AT	5.00 %	-	5.00 %	-	-	-	-	1.80 %	0.05 %
	B/BT	-	-	5.00 %	-	-	-	3.00 %	2.80 %	0.05 %
	C/CT	5.00 %	-	5.00 %	-	-	-	-	2.55 %	0.05 %
	F/FT	-	-	-	-	-	-	-	0.45 %	0.01 %
	I/IT	2.00 %	-	2.00 %	-	-	-	-	0.95 %	0.01 %
	N/NT	-	-	-	-	-	-	-	1.38 %	0.05 %
	P/PT	2.00 %	-	2.00 %	-	-	-	-	1.38 %	0.05 %
	R/RT	-	-	-	-	-	-	-	1.45 %	0.05 %
	S/ST	7.00 %	-	7.00 %	-	-	-	-	1.65 %	0.05 %
	W/WT	-	-	-	-	-	-	-	1.38 %	0.01 %
X/XT	-	-	-	-	-	-	-	1.38 %	0.01 %	
Y/YT	-	-	-	-	-	-	-	0.95 %	0.05 %	
Allianz Global Multi-Asset Credit	A/AT	3.00 %	-	3.00 %	-	-	-	-	1.30 %	0.05 %
	B/BT	-	-	3.00 %	-	-	-	3.00 %	2.30 %	0.05 %
	C/CT	3.00 %	-	3.00 %	-	-	-	-	2.05 %	0.05 %
	F/FT	-	-	-	-	-	-	-	0.20 %	0.01 %
	I/IT	2.00 %	-	2.00 %	-	-	-	-	0.90 %	0.01 %
	N/NT	-	-	-	-	-	-	-	0.90 %	0.05 %
	P/PT	-	-	-	-	-	-	-	0.90 %	0.05 %
	R/RT	-	-	-	-	-	-	-	1.05 %	0.05 %
	W/WT	-	-	-	-	-	-	-	0.90 %	0.01 %
	X/XT	-	-	-	-	-	-	-	0.70 %	0.01 %
Y/YT	-	-	-	-	-	-	-	0.90 %	0.05 %	

- Allianz Global Investors Fund -

Sub-Fund Name	Share Class	Sales Charge	Placement Fee	Conversion Fee	Redemption Fee	Disinvestment Fee	Exit Fee	CDSC	All-in-Fee (p.a.)	Taxe d' Abonnement (p.a.)
Allianz Global Multi-Asset Credit SRI	A/AT	3.00 %	-	3.00 %	-	-	-	-	1.30 %	0.05 %
	C/CT	3.00 %	-	3.00 %	-	-	-	-	2.05 %	0.05 %
	F/FT	-	-	-	-	-	-	-	0.20 %	0.01 %
	I/IT	2.00 %	-	2.00 %	-	-	-	-	0.90 %	0.01 %
	N/NT	-	-	-	-	-	-	-	0.90 %	0.05 %
	P/PT	-	-	-	-	-	-	-	0.90 %	0.05 %
	R/RT	-	-	-	-	-	-	-	1.05 %	0.05 %
	W/WT	-	-	-	-	-	-	-	0.90 %	0.01 %
	X/XT	-	-	-	-	-	-	-	0.70 %	0.01 %
Y/YT	-	-	-	-	-	-	-	0.90 %	0.05 %	
Allianz Global Multi Asset Sustainability Balanced	A/AT	5.00 %	-	5.00 %	-	-	-	-	1.65 %	0.05 %
	C/CT	5.00 %	-	5.00 %	-	-	-	-	2.40 %	0.05 %
	F/FT	-	-	-	-	-	-	-	0.25 %	0.01 %
	I/IT	2.00 %	-	2.00 %	-	-	-	-	0.89 %	0.01 %
	N/NT	-	-	-	-	-	-	-	0.61 %	0.05 %
	P/PT	2.00 %	-	2.00 %	-	-	-	-	0.89 %	0.05 %
	R/RT	-	-	-	-	-	-	-	0.95 %	0.05 %
	S/ST	7.00 %	-	7.00 %	-	-	-	-	0.95 %	0.05 %
	W/WT	-	-	-	-	-	-	-	0.61 %	0.01 %
X/XT	-	-	-	-	-	-	-	0.47 %	0.01 %	
Y/YT	-	-	-	-	-	-	-	0.89 %	0.05 %	
Allianz Global Multi Asset Sustainability Conservative	A/AT	3.00 %	-	3.00 %	-	-	-	-	1.40 %	0.05 %
	C/CT	3.00 %	-	3.00 %	-	-	-	-	2.15 %	0.05 %
	F/FT	-	-	-	-	-	-	-	0.25 %	0.01 %
	I/IT	2.00 %	-	2.00 %	-	-	-	-	0.89 %	0.01 %
	N/NT	-	-	-	-	-	-	-	0.71 %	0.05 %
	P/PT	2.00 %	-	2.00 %	-	-	-	-	0.89 %	0.05 %
	R/RT	-	-	-	-	-	-	-	0.95 %	0.05 %
	S/ST	7.00 %	-	7.00 %	-	-	-	-	0.95 %	0.05 %
	W/WT	-	-	-	-	-	-	-	0.71 %	0.01 %
X/XT	-	-	-	-	-	-	-	0.62 %	0.01 %	
Y/YT	-	-	-	-	-	-	-	0.89 %	0.05 %	
Allianz Global Multi Asset Sustainability Growth	A/AT	5.00 %	-	5.00 %	-	-	-	-	1.90 %	0.05 %
	C/CT	5.00 %	-	5.00 %	-	-	-	-	2.65 %	0.05 %
	F/FT	-	-	-	-	-	-	-	0.25 %	0.01 %
	I/IT	2.00 %	-	2.00 %	-	-	-	-	1.14 %	0.01 %
	N/NT	-	-	-	-	-	-	-	0.86 %	0.05 %
	P/PT	2.00 %	-	2.00 %	-	-	-	-	1.14 %	0.05 %
	R/RT	-	-	-	-	-	-	-	1.20 %	0.05 %
	S/ST	7.00 %	-	7.00 %	-	-	-	-	1.20 %	0.05 %
	W/WT	-	-	-	-	-	-	-	0.86 %	0.01 %
X/XT	-	-	-	-	-	-	-	0.72 %	0.01 %	
Y/YT	-	-	-	-	-	-	-	1.14 %	0.05 %	
Allianz Global Opportunistic Bond	A/AT	3.00 %	-	3.00 %	-	-	-	-	1.14 %	0.05 %
	B/BT	-	-	5.00 %	-	-	-	3.00 %	2.14 %	0.05 %
	C/CT	3.00 %	-	3.00 %	-	-	-	-	1.54 %	0.05 %
	C2/CT2/C3/CT3	-	-	2.00 %	2.00 %	-	-	-	1.14 %	0.05 %
	F/FT	-	-	-	-	-	-	-	0.14 %	0.01 %
	I/IT	-	-	-	-	-	-	-	0.63 %	0.01 %
	N/NT	-	-	-	-	-	-	-	0.44 %	0.05 %
	P/PT	-	-	-	-	-	-	-	0.63 %	0.05 %
	R/RT	-	-	-	-	-	-	-	0.67 %	0.05 %
	W/WT	-	-	-	-	-	-	-	0.44 %	0.01 %
X/XT	-	-	-	-	-	-	-	0.63 %	0.01 %	
Y/YT	-	-	-	-	-	-	-	0.63 %	0.05 %	

- Allianz Global Investors Fund -

Sub-Fund Name	Share Class	Sales Charge	Placement Fee	Conversion Fee	Redemption Fee	Disinvestment Fee	Exit Fee	CDSC	All-in-Fee (p.a.)	Taxe d' Abonnement (p.a.)
Allianz Global Small Cap Equity	A/AT	5.00 %	-	5.00 %	-	-	-	-	2.05 %	0.05 %
	C/CT	5.00 %	-	5.00 %	-	-	-	-	2.80 %	0.05 %
	I/IT	2.00 %	-	2.00 %	-	-	-	-	1.08 %	0.01 %
	N/NT	-	-	-	-	-	-	-	1.50 %	0.05 %
	P/PT	2.00 %	-	2.00 %	-	-	-	-	1.08 %	0.05 %
	PT2 (GBP)	-	-	-	-	-	-	-	0.80 %	0.05 %
	R/RT	-	-	-	-	-	-	-	1.60 %	0.05 %
	S/ST	6.00 %	-	6.00 %	-	-	-	-	1.50 %	0.05 %
	W/WT	-	-	-	-	-	-	-	1.50 %	0.01 %
	X/XT	-	-	-	-	-	-	-	1.50 %	0.01 %
Y/YT	-	-	-	-	-	-	-	1.08 %	0.05 %	
Allianz Global Sustainability	A/AT	5.00 %	-	5.00 %	-	-	-	-	1.80 %	0.05 %
	B/BT	-	-	5.00 %	-	-	-	3.00 %	2.80 %	0.05 %
	C/CT	5.00 %	-	5.00 %	-	-	-	-	2.55 %	0.05 %
	E/ET	-	-	-	-	-	-	-	1.65 %	0.05 %
	F/FT	-	-	-	-	-	-	-	1.38 %	0.01 %
	I/IT	2.00 %	-	2.00 %	-	-	-	-	1.38 %	0.01 %
	N/NT	-	-	-	-	-	-	-	1.38 %	0.05 %
	P/PT	2.00 %	-	2.00 %	-	-	-	-	1.38 %	0.05 %
	R/RT	-	-	-	-	-	-	-	1.43 %	0.05 %
	S/ST	7.00 %	-	7.00 %	-	-	-	-	1.50 %	0.05 %
	W/WT	-	-	-	-	-	-	-	1.38 %	0.01 %
	X/XT	-	-	-	-	-	-	-	1.38 %	0.01 %
Y/YT	-	-	-	-	-	-	-	1.38 %	0.05 %	
Allianz Global Water	A/AT	5.00 %	-	5.00 %	-	-	-	-	2.35 %	0.05 %
	C/CT	-	-	-	-	-	-	-	3.10 %	0.05 %
	I/IT	2.00 %	-	2.00 %	-	-	-	-	1.38 %	0.01 %
	P/PT	-	-	-	-	-	-	-	1.38 %	0.05 %
	R/RT	-	-	-	-	-	-	-	1.48 %	0.05 %
	W/WT	-	-	-	-	-	-	-	1.03 %	0.01 %
	X/XT	-	-	-	-	-	-	-	1.38 %	0.01 %
	Y/YT	-	-	-	-	-	-	-	1.38 %	0.05 %
Allianz Green Bond	A/AT	5.00 %	-	5.00 %	-	-	-	-	1.09 %	0.05 %
	B/BT	-	-	5.00 %	-	-	-	3.00 %	2.09 %	0.05 %
	C/CT	5.00 %	-	5.00 %	-	-	-	-	1.84 %	0.05 %
	I/IT	2.00 %	-	2.00 %	-	-	-	-	0.60 %	0.01 %
	N/NT	-	-	-	-	-	-	-	0.42 %	0.05 %
	P/PT	2.00 %	-	2.00 %	-	-	-	-	0.60 %	0.05 %
	R/RT	-	-	-	-	-	-	-	0.87 %	0.05 %
	S/ST	7.00 %	-	7.00 %	-	-	-	-	0.64 %	0.05 %
	W/WT	-	-	-	-	-	-	-	0.42 %	0.01 %
	X/XT	-	-	-	-	-	-	-	0.33 %	0.01 %
Y/YT	-	-	-	-	-	-	-	0.60 %	0.05 %	
Allianz Green Future	A/AT	4.00 %	-	4.00 %	-	-	-	-	1.50 %	0.05 %
	C/CT	-	2.50 %	-	-	-	2.50 %	-	2.25 %	0.05 %
	I/IT	2.00 %	-	2.00 %	-	-	-	-	1.00 %	0.01 %
	N/NT	-	-	-	-	-	-	-	1.00 %	0.05 %
	P/PT	2.00 %	-	2.00 %	-	-	-	-	1.00 %	0.05 %
	R/RT	-	-	-	-	-	-	-	1.00 %	0.05 %
	S/ST	7.00 %	-	7.00 %	-	-	-	-	1.00 %	0.05 %
	W/WT	-	-	-	-	-	-	-	0.80 %	0.01 %
	W6/WT6	-	2.50 %	-	-	-	2.50 %	-	0.80 %	0.01 %
	X/XT	-	-	-	-	-	-	-	0.70 %	0.01 %
Allianz Green Transition Bond	A/AT	5.00 %	-	5.00 %	-	-	-	-	1.29 %	0.05 %
	C/CT	5.00 %	-	5.00 %	-	-	-	-	1.99 %	0.05 %
	F/FT	-	-	-	-	-	-	-	1.00 %	0.05 %
	I/IT	2.00 %	-	2.00 %	-	-	-	-	0.80 %	0.01 %
	N/NT	-	-	-	-	-	-	-	0.62 %	0.05 %
	P/PT	2.00 %	-	2.00 %	-	-	-	-	0.80 %	0.05 %
	R/RT	-	-	-	-	-	-	-	0.84 %	0.05 %
	S/ST	-	-	-	-	-	-	-	0.84 %	0.05 %
	W/WT	-	-	-	-	-	-	-	0.62 %	0.01 %
	X/XT	-	-	-	-	-	-	-	0.53 %	0.01 %
Y/YT	-	-	-	-	-	-	-	0.57 %	0.05 %	

- Allianz Global Investors Fund -

Sub-Fund Name	Share Class	Sales Charge	Placement Fee	Conversion Fee	Redemption Fee	Disinvestment Fee	Exit Fee	CDSC	All-in-Fee (p.a.)	Taxe d' Abonnement (p.a.)
Allianz High Dividend Asia Pacific Equity	A/AT	5.00 %	-	5.00 %	-	-	-	-	2.05 %	0.05 %
	C/CT	5.00 %	-	5.00 %	-	-	-	-	2.05 %	0.05 %
	I/IT	-	-	-	-	-	-	-	0.90 %	0.01 %
	N/NT	-	-	-	-	-	-	-	1.50 %	0.05 %
	P/PT	-	-	-	-	-	-	-	1.50 %	0.05 %
	R/RT	-	-	-	-	-	-	-	1.50 %	0.05 %
	S/ST	7.00 %	-	7.00 %	-	-	-	-	1.50 %	0.05 %
	W/WT	-	-	-	-	-	-	-	0.70 %	0.01 %
	X/XT	-	-	-	-	-	-	-	1.50 %	0.01 %
Y/YT	-	-	-	-	-	-	-	0.90 %	0.05 %	
Allianz HKD Income	A/AT	5.00 %	-	5.00 %	-	-	-	-	1.00 %	0.05 %
	C/CT	5.00 %	-	5.00 %	-	-	-	-	1.75 %	0.05 %
	I/IT	2.00 %	-	2.00 %	-	-	-	-	0.57 %	0.01 %
	N/NT	-	-	-	-	-	-	-	0.85 %	0.05 %
	P/PT	-	-	-	-	-	-	-	0.85 %	0.05 %
	P8/PT8/P9/PT9	2.00 %	-	2.00 %	-	-	-	-	0.65 %	0.05 %
	R/RT	-	-	-	-	-	-	-	1.00 %	0.05 %
	S/ST	6.00 %	-	6.00 %	-	-	-	-	1.00 %	0.05 %
	W/WT	-	-	-	-	-	-	-	0.85 %	0.01 %
X/XT	-	-	-	-	-	-	-	0.85 %	0.01 %	
Y/YT	-	-	-	-	-	-	-	0.57 %	0.05 %	
Allianz Hong Kong Equity	A/AT	5.00 %	-	5.00 %	-	-	-	-	2.05 %	0.05 %
	AT (SGD)	5.00 %	-	5.00 %	-	-	-	-	1.80 %	0.05 %
	C/CT	5.00 %	-	5.00 %	-	-	-	-	2.80 %	0.05 %
	I/IT	-	-	-	-	-	-	-	1.08 %	0.01 %
	N/NT	-	-	-	-	-	-	-	1.53 %	0.05 %
	P/PT	-	-	-	-	-	-	-	1.53 %	0.05 %
	R/RT	-	-	-	-	-	-	-	1.60 %	0.05 %
	S/ST	7.00 %	-	7.00 %	-	-	-	-	1.84 %	0.05 %
	W/WT	-	-	-	-	-	-	-	1.53 %	0.01 %
X/XT	-	-	-	-	-	-	-	1.53 %	0.01 %	
Y/YT	-	-	-	-	-	-	-	1.08 %	0.05 %	
Allianz Income and Growth	A/AT	5.00 %	-	5.00 %	-	-	-	-	1.50 %	0.05 %
	B/BT	-	-	5.00 %	-	-	-	3.00 %	2.50 %	0.05 %
	C/CT	5.00 %	-	5.00 %	-	-	-	-	2.25 %	0.05 %
	I/IT	2.00 %	-	2.00 %	-	-	-	-	0.84 %	0.01 %
	N/NT	-	-	-	-	-	-	-	1.15 %	0.05 %
	P/PT	2.00 %	-	2.00 %	-	-	-	-	0.84 %	0.05 %
	P8/PT8/P9/PT9	2.00 %	-	2.00 %	-	-	-	-	0.97 %	0.05 %
	R/RT	-	-	-	-	-	-	-	1.20 %	0.05 %
	S/ST	7.00 %	-	7.00 %	-	-	-	-	1.38 %	0.05 %
W/WT	-	-	-	-	-	-	-	1.15 %	0.01 %	
X/XT	-	-	-	-	-	-	-	1.15 %	0.01 %	
Y/YT	-	-	-	-	-	-	-	0.84 %	0.05 %	
Allianz India Equity	A/AT	5.00 %	-	5.00 %	-	-	-	-	2.50 %	0.05 %
	C/CT	5.00 %	-	5.00 %	-	-	-	-	3.00 %	0.05 %
	I/IT	-	-	-	-	-	-	-	1.28 %	0.01 %
	N/NT	-	-	-	-	-	-	-	2.00 %	0.05 %
	P/PT	-	-	-	-	-	-	-	2.00 %	0.05 %
	R/RT	-	-	-	-	-	-	-	2.40 %	0.05 %
	S/ST	7.00 %	-	7.00 %	-	-	-	-	2.00 %	0.05 %
	W/WT	-	-	-	-	-	-	-	2.00 %	0.01 %
	X/XT	-	-	-	-	-	-	-	2.00 %	0.01 %
Y/YT	-	-	-	-	-	-	-	1.28 %	0.05 %	
Allianz Indonesia Equity	A/AT	5.00 %	-	5.00 %	-	-	-	-	2.25 %	0.05 %
	C/CT	5.00 %	-	5.00 %	-	-	-	-	3.00 %	0.05 %
	I/IT	-	-	-	-	-	-	-	1.85 %	0.01 %
	N/NT	-	-	-	-	-	-	-	1.85 %	0.05 %
	P/PT	-	-	-	-	-	-	-	1.85 %	0.05 %
	R/RT	-	-	-	-	-	-	-	2.20 %	0.05 %
	S/ST	7.00 %	-	7.00 %	-	-	-	-	2.19 %	0.05 %
	W/WT	-	-	-	-	-	-	-	1.85 %	0.01 %
	X/XT	-	-	-	-	-	-	-	1.85 %	0.01 %
Y/YT	-	-	-	-	-	-	-	1.85 %	0.05 %	

- Allianz Global Investors Fund -

Sub-Fund Name	Share Class	Sales Charge	Placement Fee	Conversion Fee	Redemption Fee	Disinvestment Fee	Exit Fee	CDSC	All-in-Fee (p.a.)	Taxe d' Abonnement (p.a.)
Allianz Japan Equity	A/AT	5.00 %	-	5.00 %	-	-	-	-	1.80 %	0.05 %
	C/CT	5.00 %	-	5.00 %	-	-	-	-	2.55 %	0.05 %
	F/FT	-	-	-	-	-	-	-	0.45 %	0.01 %
	I/IT	-	-	-	-	-	-	-	0.95 %	0.01 %
	N/NT	-	-	-	-	-	-	-	1.38 %	0.05 %
	P/PT	-	-	-	-	-	-	-	1.38 %	0.05 %
	R/RT	-	-	-	-	-	-	-	1.45 %	0.05 %
	S/ST	7.00 %	-	7.00 %	-	-	-	-	1.65 %	0.05 %
	W/WT	-	-	-	-	-	-	-	0.65 %	0.01 %
	X/XT	-	-	-	-	-	-	-	1.38 %	0.01 %
Y/YT	-	-	-	-	-	-	-	0.95 %	0.05 %	
Allianz Japan Smaller Companies Equity	A/AT	5.00 %	-	5.00 %	-	-	-	-	2.35 %	0.05 %
	C/CT	5.00 %	-	5.00 %	-	-	-	-	3.10 %	0.05 %
	I/IT	2.00 %	-	2.00 %	-	-	-	-	1.38 %	0.01 %
	N/NT	-	-	-	-	-	-	-	1.03 %	0.05 %
	P/PT	2.00 %	-	2.00 %	-	-	-	-	1.38 %	0.05 %
	R/RT	-	-	-	-	-	-	-	1.48 %	0.05 %
	S/ST	-	-	-	-	-	-	-	1.48 %	0.05 %
	W/WT	-	-	-	-	-	-	-	1.03 %	0.01 %
	X/XT	-	-	-	-	-	-	-	0.85 %	0.01 %
	Y/YT	-	-	-	-	-	-	-	0.92 %	0.05 %
Allianz Laufzeitfonds	A/AT	2.00 %	-	2.00 %	-	2.00 %	-	-	0.85 %	0.05 %
	A2/AT2	-	2.00 %	-	-	2.00 %	2.00 %	-	0.85 %	0.05 %
	C/CT	2.00 %	-	2.00 %	-	2.00 %	-	-	1.20 %	0.05 %
	C6/CT6	-	2.00 %	-	-	2.00 %	2.00 %	-	1.20 %	0.05 %
	I/IT	2.00 %	-	2.00 %	-	2.00 %	-	-	0.46 %	0.01 %
	N/NT	-	-	-	-	2.00 %	-	-	0.32 %	0.05 %
	P/PT	2.00 %	-	2.00 %	-	2.00 %	-	-	0.46 %	0.05 %
	R/RT	-	-	-	-	2.00 %	-	-	0.50 %	0.05 %
	S/ST	-	-	-	-	2.00 %	-	-	0.50 %	0.05 %
	W/WT	-	-	-	-	2.00 %	-	-	0.32 %	0.01 %
W6/WT6	-	2.00 %	-	-	2.00 %	2.00 %	-	0.32 %	0.01 %	
X/XT	-	-	-	-	2.00 %	-	-	0.28 %	0.01 %	
Allianz Little Dragons	A/AT	5.00 %	-	5.00 %	-	-	-	-	2.50 %	0.05 %
	A (USD) /AT (USD)	5.00 %	-	5.00 %	-	-	-	-	3.25 %	0.05 %
	A2 (EUR)	5.00 %	-	5.00 %	-	-	-	-	2.25 %	0.05 %
	C/CT	5.00 %	-	5.00 %	-	-	-	-	3.00 %	0.05 %
	I/IT	-	-	-	-	-	-	-	2.00 %	0.01 %
	N/NT	-	-	-	-	-	-	-	2.00 %	0.05 %
	P/PT	-	-	-	-	-	-	-	2.00 %	0.05 %
	R/RT	-	-	-	-	-	-	-	2.20 %	0.05 %
	S/ST	7.00 %	-	7.00 %	-	-	-	-	2.38 %	0.05 %
	W/WT	-	-	-	-	-	-	-	2.00 %	0.01 %
X/XT	-	-	-	-	-	-	-	2.00 %	0.01 %	
Y/YT	-	-	-	-	-	-	-	2.00 %	0.05 %	
Allianz Metaverse	A/AT	5.00 %	-	5.00 %	-	-	-	-	2.35 %	0.05 %
	C/CT	5.00 %	-	5.00 %	-	-	-	-	2.35 %	0.05 %
	I/IT	2.00 %	-	2.00 %	-	-	-	-	1.38 %	0.01 %
	N/NT	-	-	-	-	-	-	-	1.03 %	0.05 %
	P/PT	2.00 %	-	2.00 %	-	-	-	-	1.38 %	0.05 %
	R/RT	-	-	-	-	-	-	-	1.48 %	0.05 %
	S/ST	7.00 %	-	7.00 %	-	-	-	-	1.48 %	0,05 %
	W/WT	-	-	-	-	-	-	-	1.03 %	0.01 %
	X/XT	-	-	-	-	-	-	-	0.85 %	0.01 %
	Y/YT	-	-	-	-	-	-	-	0.92 %	0.05 %

- Allianz Global Investors Fund -

Sub-Fund Name	Share Class	Sales Charge	Placement Fee	Conversion Fee	Redemption Fee	Disinvestment Fee	Exit Fee	CDSC	All-in-Fee (p.a.)	Taxe d' Abonnement (p.a.)
Allianz Multi Asset Long / Short	A/AT	5.00 %	-	5.00 %	-	-	-	-	1.75 %	0.05 %
	C/CT	5.00 %	-	5.00 %	-	-	-	-	3.25 %	0.05 %
	I/IT	2.00 %	-	2.00 %	-	-	-	-	0.99 %	0.01 %
	I3/IT3	2.00 %	-	2.00 %	-	-	-	-	1.69 %	0.01 %
	N/NT	-	-	-	-	-	-	-	1.75 %	0.05 %
	P/PT	2.00 %	-	2.00 %	-	-	-	-	0.99 %	0.05 %
	P3/PT3	2.00 %	-	2.00 %	-	-	-	-	1.69 %	0.05 %
	R/RT	-	-	-	-	-	-	-	1.05 %	0.05 %
	R3/RT3	-	-	-	-	-	-	-	1.75 %	0.05 %
	S/ST	7.00 %	-	7.00 %	-	-	-	-	1.75 %	0.05 %
	W/WT	-	-	-	-	-	-	-	0.99 %	0.01 %
	X/XT	-	-	-	-	-	-	-	1.75 %	0.01 %
Y/YT	-	-	-	-	-	-	-	0.99 %	0.05 %	
Allianz Multi Asset Opportunities	A/AT	5.00 %	-	5.00 %	-	-	-	-	1.20 %	0.05 %
	C/CT	5.00 %	-	5.00 %	-	-	-	-	3.25 %	0.05 %
	I/IT	2.00 %	-	2.00 %	-	-	-	-	0.75 %	0.01 %
	I3/IT3	2.00 %	-	2.00 %	-	-	-	-	0.94 %	0.01 %
	N/NT	-	-	-	-	-	-	-	1.75 %	0.05 %
	P/PT	2.00 %	-	2.00 %	-	-	-	-	0.75 %	0.05 %
	P3/PT3	2.00 %	-	2.00 %	-	-	-	-	0.94 %	0.05 %
	R/RT	-	-	-	-	-	-	-	0.65 %	0.05 %
	R3/RT3	-	-	-	-	-	-	-	1.00 %	0.05 %
	S/ST	7.00 %	-	7.00 %	-	-	-	-	1.75 %	0.05 %
	W/WT	-	-	-	-	-	-	-	0.59 %	0.01 %
	X/XT	-	-	-	-	-	-	-	1.75 %	0.01 %
Y/YT	-	-	-	-	-	-	-	0.75 %	0.05 %	
Allianz Multi Asset Risk Premia	A/AT	5.00 %	-	5.00 %	-	-	-	-	2.05 %	0.05 %
	C/CT	5.00 %	-	5.00 %	-	-	-	-	2.80 %	0.05 %
	I/IT	2.00 %	-	2.00 %	-	-	-	-	0.49 %	0.01 %
	I3/IT3	2.00 %	-	2.00 %	-	-	-	-	1.24 %	0.01 %
	N/NT	-	-	-	-	-	-	-	1.49 %	0.05 %
	P/PT	2.00 %	-	2.00 %	-	-	-	-	0.49 %	0.05 %
	P3/PT3	2.00 %	-	2.00 %	-	-	-	-	1.24 %	0.05 %
	R/RT	-	-	-	-	-	-	-	0.55 %	0.05 %
	R3/RT3	-	-	-	-	-	-	-	1.30 %	0.05 %
	W/WT	-	-	-	-	-	-	-	1.09 %	0.01 %
	X/XT	-	-	-	-	-	-	-	1.09 %	0.01 %
	Y/YT	-	-	-	-	-	-	-	0.85 %	0.05 %
Allianz Oriental Income	A/AT	5.00 %	-	5.00 %	-	-	-	-	1.80 %	0.05 %
	C/CT	5.00 %	-	5.00 %	-	-	-	-	2.55 %	0.05 %
	E/ET	-	-	-	-	-	-	-	1.65 %	0.05 %
	I/IT	-	-	-	-	-	-	-	0.95 %	0.01 %
	N/NT	-	-	-	-	-	-	-	1.38 %	0.05 %
	P/PT	-	-	-	-	-	-	-	0.95 %	0.05 %
	R/RT	-	-	-	-	-	-	-	1.45 %	0.05 %
	S/ST	7.00 %	-	7.00 %	-	-	-	-	1.65 %	0.05 %
	W/WT	-	-	-	-	-	-	-	1.38 %	0.01 %
	X/XT	-	-	-	-	-	-	-	1.38 %	0.01 %
	Y/YT	-	-	-	-	-	-	-	0.95 %	0.05 %
	Allianz Pet and Animal Wellbeing	A/AT	5.00 %	-	5.00 %	-	-	-	-	2.35 %
B/BT		-	-	5.00 %	-	-	-	3.00 %	3.35 %	0.05 %
C/CT		-	-	-	-	-	-	-	3.10 %	0.05 %
I/IT		2.00 %	-	2.00 %	-	-	-	-	1.38 %	0.01 %
P/PT		-	-	-	-	-	-	-	1.38 %	0.05 %
R/RT		-	-	-	-	-	-	-	1.48 %	0.05 %
W/WT		-	-	-	-	-	-	-	1.03 %	0.01 %
X/XT		-	-	-	-	-	-	-	1.38 %	0.01 %
Y/YT	-	-	-	-	-	-	-	1.38 %	0.05 %	

- Allianz Global Investors Fund -

Sub-Fund Name	Share Class	Sales Charge	Placement Fee	Conversion Fee	Redemption Fee	Disinvestment Fee	Exit Fee	CDSC	All-in-Fee (p.a.)	Taxe d' Abonnement (p.a.)
Allianz Positive Change	A/AT	5.00 %	-	5.00 %	-	-	-	-	2.35 %	0.05 %
	C/CT	-	-	-	-	-	-	-	3.10 %	0.05 %
	C6/CT6	-	3.00 %	-	-	-	3.00 %	-	3.10 %	0.05 %
	I/IT	2.00 %	-	2.00 %	-	-	-	-	1.38 %	0.01 %
	P/PT	-	-	-	-	-	-	-	1.38 %	0.05 %
	R/RT	-	-	-	-	-	-	-	1.48 %	0.05 %
	W/WT	-	-	-	-	-	-	-	1.03 %	0.01 %
	W6/WT6	-	3.00 %	-	-	-	-	3.00 %	1.03 %	0.01 %
	X/XT	-	-	-	-	-	-	-	1.38 %	0.01 %
Y/YT	-	-	-	-	-	-	-	0.92 %	0.05 %	
Allianz Premium Champions	A/AT	5.00 %	-	5.00 %	-	-	-	-	2.10 %	0.05 %
	C/CT	5.00 %	-	5.00 %	-	-	-	-	3.60 %	0.05 %
	I/IT	2.00 %	-	2.00 %	-	-	-	-	1.25 %	0.01 %
	P/PT	2.00 %	-	2.00 %	-	-	-	-	1.25 %	0.05 %
	R/RT	-	-	-	-	-	-	-	1.35 %	0.05 %
	W/WT	-	-	-	-	-	-	-	0.95 %	0.01 %
	X/XT	-	-	-	-	-	-	-	0.80 %	0.01 %
Y/YT	-	-	-	-	-	-	-	0.86 %	0.05 %	
Allianz Renminbi Fixed Income	A/AT	3.00 %	-	3.00 %	-	-	-	-	0.99 %	0.05 %
	C/CT	3.00 %	-	3.00 %	-	-	-	-	1.19 %	0.05 %
	I/IT	-	-	-	-	-	-	-	0.55 %	0.01 %
	N/NT	-	-	-	-	-	-	-	0.78 %	0.05 %
	P/PT	-	-	-	-	-	-	-	0.55 %	0.05 %
	R/RT	-	-	-	-	-	-	-	0.80 %	0.05 %
	S/ST	5.00 %	-	5.00 %	-	-	-	-	0.93 %	0.05 %
	W/WT	-	-	-	-	-	-	-	0.78 %	0.01 %
	X/XT	-	-	-	-	-	-	-	0.78 %	0.01 %
Y/YT	-	-	-	-	-	-	-	0.55 %	0.05 %	
Allianz SDG Euro Credit	A/AT	3.00 %	-	3.00 %	-	-	-	-	1.44 %	0.05 %
	C/CT	3.00 %	-	3.00 %	-	-	-	-	2.19 %	0.05 %
	I/IT	2.00 %	-	2.00 %	-	-	-	-	0.60 %	0.01 %
	N/NT	-	-	-	-	-	-	-	1.05 %	0.05 %
	P/PT	2.00 %	-	2.00 %	-	-	-	-	1.05 %	0.05 %
	R/RT	-	-	-	-	-	-	-	1.30 %	0.05 %
	S/ST	5.00 %	-	5.00 %	-	-	-	-	1.27 %	0.05 %
	W/WT	-	-	-	-	-	-	-	1.05 %	0.01 %
	X/XT	-	-	-	-	-	-	-	1.05 %	0.01 %
Y/YT	-	-	-	-	-	-	-	0.60 %	0.05 %	
Allianz SDG Global Equity	A/AT	5.00 %	-	5.00 %	-	-	-	-	1.90 %	0.05 %
	C/CT	5.00 %	-	5.00 %	-	-	-	-	2.60 %	0.05 %
	I/IT	2.00 %	-	2.00 %	-	-	-	-	1.15 %	0.01 %
	N/NT	-	-	-	-	-	-	-	0.89 %	0.05 %
	P/PT	2.00 %	-	2.00 %	-	-	-	-	1.15 %	0.05 %
	R/RT	-	-	-	-	-	-	-	1.25 %	0.05 %
	S/ST	-	-	-	-	-	-	-	1.25 %	0.05 %
	W/WT	-	-	-	-	-	-	-	0.89 %	0.01 %
	X/XT	-	-	-	-	-	-	-	0.76 %	0.01 %
Allianz Select Income and Growth	A/AT	5.00 %	-	5.00 %	-	-	-	-	1.50 %	0.05 %
	B/BT	-	-	5.00 %	-	-	-	3.00 %	2.50 %	0.05 %
	C/CT	5.00 %	-	5.00 %	-	-	-	-	2.25 %	0.05 %
	I/IT	2.00 %	-	2.00 %	-	-	-	-	0.84 %	0.01 %
	N/NT	-	-	-	-	-	-	-	1.15 %	0.05 %
	P/PT	2.00 %	-	2.00 %	-	-	-	-	0.84 %	0.05 %
	P8/PT8/P9/PT9	2.00 %	-	2.00 %	-	-	-	-	0.97 %	0.05 %
	R/RT	-	-	-	-	-	-	-	1.20 %	0.05 %
	S/ST	7.00 %	-	7.00 %	-	-	-	-	1.38 %	0.05 %
	W/WT	-	-	-	-	-	-	-	1.15 %	0.01 %
	X/XT	-	-	-	-	-	-	-	1.15 %	0.01 %
Y/YT	-	-	-	-	-	-	-	0.84 %	0.05 %	

- Allianz Global Investors Fund -

Sub-Fund Name	Share Class	Sales Charge	Placement Fee	Conversion Fee	Redemption Fee	Disinvestment Fee	Exit Fee	CDSC	All-in-Fee (p.a.)	Taxe d' Abonnement (p.a.)
Allianz Selection Alternative	A/AT	5.00 %	-	5.00 %	-	-	-	-	2.05 %	0.05 %
	C/CT	5.00 %	-	5.00 %	-	-	-	-	2.80 %	0.05 %
	I/IT	2.00 %	-	2.00 %	-	-	-	-	1.50 %	0.01 %
	N/NT	-	-	-	-	-	-	-	1.50 %	0.05 %
	P/PT	2.00 %	-	2.00 %	-	-	-	-	1.50 %	0.05 %
	R/RT	-	-	-	-	-	-	-	1.60 %	0.05 %
	S/ST	7.00 %	-	7.00 %	-	-	-	-	1.50 %	0.05 %
	W/WT	-	-	-	-	-	-	-	1.50 %	0.01 %
	X/XT	-	-	-	-	-	-	-	1.50 %	0.01 %
Y/YT	-	-	-	-	-	-	-	1.50 %	0.05 %	
Allianz Selection Fixed Income	A/AT	5.00 %	-	5.00 %	-	-	-	-	2.05 %	0.05 %
	C/CT	5.00 %	-	5.00 %	-	-	-	-	2.80 %	0.05 %
	I/IT	2.00 %	-	2.00 %	-	-	-	-	1.50 %	0.01 %
	N/NT	-	-	-	-	-	-	-	1.50 %	0.05 %
	P/PT	2.00 %	-	2.00 %	-	-	-	-	1.50 %	0.05 %
	R/RT	-	-	-	-	-	-	-	1.60 %	0.05 %
	S/ST	7.00 %	-	7.00 %	-	-	-	-	1.50 %	0.05 %
	W/WT	-	-	-	-	-	-	-	1.50 %	0.01 %
	X/XT	-	-	-	-	-	-	-	1.50 %	0.01 %
Y/YT	-	-	-	-	-	-	-	1.50 %	0.05 %	
Allianz Selection Small and Mid Cap Equity	A/AT	5.00 %	-	5.00 %	-	-	-	-	2.05 %	0.05 %
	C/CT	5.00 %	-	5.00 %	-	-	-	-	2.80 %	0.05 %
	F/FT	-	-	-	-	-	-	-	2.05 %	0.01 %
	I/IT	2.00 %	-	2.00 %	-	-	-	-	1.50 %	0.01 %
	N/NT	-	-	-	-	-	-	-	1.50 %	0.05 %
	P/PT	2.00 %	-	2.00 %	-	-	-	-	1.50 %	0.05 %
	R/RT	-	-	-	-	-	-	-	1.60 %	0.05 %
	S/ST	7.00 %	-	7.00 %	-	-	-	-	1.50 %	0.05 %
	W/WT	-	-	-	-	-	-	-	1.50 %	0.01 %
X/XT	-	-	-	-	-	-	-	1.50 %	0.01 %	
Y/YT	-	-	-	-	-	-	-	1.50 %	0.05 %	
Allianz Selective Global High Income	A/AT	3.00 %	-	3.00 %	-	-	-	-	1.45 %	0.05 %
	C/CT	3.00 %	-	3.00 %	-	-	-	-	2.20 %	0.05 %
	I/IT	2.00 %	-	2.00 %	-	-	-	-	1.10 %	0.01 %
	N/NT	-	-	-	-	-	-	-	1.10 %	0.05 %
	P/PT	-	-	-	-	-	-	-	1.10 %	0.05 %
	R/RT	-	-	-	-	-	-	-	1.20 %	0.05 %
	W/WT	-	-	-	-	-	-	-	1.10 %	0.01 %
	X/XT	-	-	-	-	-	-	-	0.90 %	0.01 %
	Y/YT	-	-	-	-	-	-	-	1.10 %	0.05 %
Allianz SGD Income	A/AT	5.00 %	-	5.00 %	-	-	-	-	1.20 %	0.05 %
	C/CT	-	2.00 %	-	2.00 %	-	2.00 %	-	1.20 %	0.05 %
	I/IT	2.00 %	-	2.00 %	-	-	-	-	0.77 %	0.01 %
	N/NT	-	-	-	-	-	-	-	0.62 %	0.05 %
	P/PT	2.00 %	-	2.00 %	-	-	-	-	0.77 %	0.05 %
	R/RT	-	-	-	-	-	-	-	0.83 %	0.05 %
	S/ST	-	-	-	-	-	-	-	1.20 %	0.05 %
	W/WT	-	-	-	-	-	-	-	0.62 %	0.01 %
	X/XT	-	-	-	-	-	-	-	0.39 %	0.01 %
Y/YT	-	-	-	-	-	-	-	0.77 %	0.05 %	
Allianz Short Duration Global Bond SRI	A/AT	3.00 %	-	3.00 %	-	-	-	-	1.20 %	0.05 %
	C/CT	3.00 %	-	3.00 %	-	-	-	-	1.95 %	0.05 %
	I/IT	-	-	-	-	-	-	-	0.50 %	0.01 %
	N/NT	-	-	-	-	-	-	-	1.00 %	0.05 %
	P/PT	2.00 %	-	2.00 %	-	-	-	-	0.60 %	0.05 %
	R/RT	-	-	-	-	-	-	-	1.10 %	0.05 %
	S/ST	5.00 %	-	5.00 %	-	-	-	-	1.00 %	0.05 %
	W/WT	-	-	-	-	-	-	-	0.40 %	0.01 %
	X/XT	-	-	-	-	-	-	-	1.00 %	0.01 %
Y/YT	-	-	-	-	-	-	-	0.50 %	0.05 %	

- Allianz Global Investors Fund -

Sub-Fund Name	Share Class	Sales Charge	Placement Fee	Conversion Fee	Redemption Fee	Disinvestment Fee	Exit Fee	CDSC	All-in-Fee (p.a.)	Taxe d' Abonnement (p.a.)
Allianz Smart Energy	A/AT	5.00 %	-	5.00 %	-	-	-	-	2.35 %	0.05 %
	B/BT	-	-	5.00 %	-	-	-	3.00 %	3.35 %	0.05 %
	C/CT	-	-	-	-	-	-	-	3.10 %	0.05 %
	C6/CT6	-	3.00 %	-	-	-	3.00 %	-	3.10 %	0.05 %
	I/IT	2.00 %	-	2.00 %	-	-	-	-	1.38 %	0.01 %
	P/PT	-	-	-	-	-	-	-	1.38 %	0.05 %
	R/RT	-	-	-	-	-	-	-	1.48 %	0.05 %
	W/WT	-	-	-	-	-	-	-	1.03 %	0.01 %
	W6/WT6	-	3.00 %	-	-	-	3.00 %	-	1.03 %	0.01 %
	X/XT	-	-	-	-	-	-	-	1.38 %	0.01 %
Y/YT	-	-	-	-	-	-	-	0.92 %	0.05 %	
Allianz Social Conviction Equity	A/AT	5.00 %	-	5.00 %	-	-	-	-	2.10 %	0.05 %
	C/CT	5.00 %	-	5.00 %	-	-	-	-	2.80 %	0.05 %
	I/IT	2.00 %	-	2.00 %	-	-	-	-	1.25 %	0.01 %
	N/NT	-	-	-	-	-	-	-	0.95 %	0.05 %
	P/PT	2.00 %	-	2.00 %	-	-	-	-	1.25 %	0.05 %
	R/RT	-	-	-	-	-	-	-	1.35 %	0.05 %
	W/WT	-	-	-	-	-	-	-	0.95 %	0.01 %
	X/XT	-	-	-	-	-	-	-	0.80 %	0.01 %
	Y/YT	-	-	-	-	-	-	-	0.86 %	0.05 %
Allianz Strategic Bond	A/AT	3.00 %	-	3.00 %	-	-	-	-	1.30 %	0.05 %
	C/CT	3.00 %	-	3.00 %	-	-	-	-	2.05 %	0.05 %
	F/FT	-	-	-	-	-	-	-	0.20 %	0.01 %
	I/IT	2.00 %	-	2.00 %	-	-	-	-	0.90 %	0.01 %
	N/NT	-	-	-	-	-	-	-	0.90 %	0.05 %
	P/PT	-	-	-	-	-	-	-	0.90 %	0.05 %
	R/RT	-	-	-	-	-	-	-	1.05 %	0.05 %
	W/WT	-	-	-	-	-	-	-	0.90 %	0.01 %
	X/XT	-	-	-	-	-	-	-	0.70 %	0.01 %
	Y/YT	-	-	-	-	-	-	-	0.90 %	0.05 %
Allianz Strategy Select 30	A/AT	5.00 %	-	5.00 %	-	-	-	-	1.80 %	0.05 %
	C/CT	5.00 %	-	5.00 %	-	-	-	-	2.00 %	0.05 %
	I/IT	-	-	-	-	-	-	-	1.60 %	0.01 %
	N/NT	-	-	-	-	-	-	-	1.50 %	0.05 %
	P/PT	2.00 %	-	2.00 %	-	-	-	-	1.60 %	0.05 %
	R/RT	-	-	-	-	-	-	-	1.70 %	0.05 %
	S/ST	7.00 %	-	7.00 %	-	-	-	-	1.50 %	0.05 %
	W/WT	-	-	-	-	-	-	-	0.60 %	0.01 %
	X/XT	-	-	-	-	-	-	-	0.30 %	0.01 %
	Y/YT	-	-	-	-	-	-	-	1.60 %	0.05 %
Allianz Strategy Select 50	A/AT	5.00 %	-	5.00 %	-	-	-	-	1.80 %	0.05 %
	C/CT	5.00 %	-	5.00 %	-	-	-	-	2.00 %	0.05 %
	I/IT	-	-	-	-	-	-	-	1.60 %	0.01 %
	N/NT	-	-	-	-	-	-	-	1.50 %	0.05 %
	P/PT	2.00 %	-	2.00 %	-	-	-	-	1.60 %	0.05 %
	R/RT	-	-	-	-	-	-	-	1.70 %	0.05 %
	S/ST	7.00 %	-	7.00 %	-	-	-	-	1.50 %	0.05 %
	W/WT	-	-	-	-	-	-	-	0.60 %	0.01 %
	X/XT	-	-	-	-	-	-	-	0.30 %	0.01 %
Y/YT	-	-	-	-	-	-	-	1.60 %	0.05 %	
Allianz Strategy Select 75	A/AT	5.00 %	-	5.00 %	-	-	-	-	1.80 %	0.05 %
	C/CT	5.00 %	-	5.00 %	-	-	-	-	2.00 %	0.05 %
	I/IT	-	-	-	-	-	-	-	1.60 %	0.01 %
	N/NT	-	-	-	-	-	-	-	1.50 %	0.05 %
	P/PT	2.00 %	-	2.00 %	-	-	-	-	1.60 %	0.05 %
	R/RT	-	-	-	-	-	-	-	1.70 %	0.05 %
	S/ST	7.00 %	-	7.00 %	-	-	-	-	1.50 %	0.05 %
	W/WT	-	-	-	-	-	-	-	0.60 %	0.01 %
	X/XT	-	-	-	-	-	-	-	0.30 %	0.01 %
	Y/YT	-	-	-	-	-	-	-	1.60 %	0.05 %

- Allianz Global Investors Fund -

Sub-Fund Name	Share Class	Sales Charge	Placement Fee	Conversion Fee	Redemption Fee	Disinvestment Fee	Exit Fee	CDSC	All-in-Fee (p.a.)	Taxe d' Abonnement (p.a.)
Allianz Strategy4Life 30	A/AT	5.00 %	-	5.00 %	-	-	-	-	1.80 %	0.05 %
	C/CT	5.00 %	-	5.00 %	-	-	-	-	2.00 %	0.05 %
	I/IT	-	-	-	-	-	-	-	1.60 %	0.01 %
	N/NT	-	-	-	-	-	-	-	1.50 %	0.05 %
	P/PT	2.00 %	-	2.00 %	-	-	-	-	1.60 %	0.05 %
	R/RT	-	-	-	-	-	-	-	1.70 %	0.05 %
	S/ST	7.00 %	-	7.00 %	-	-	-	-	1.50 %	0.05 %
	W/WT	-	-	-	-	-	-	-	0.60 %	0.01 %
	X/XT	-	-	-	-	-	-	-	0.30 %	0.01 %
Y/YT	-	-	-	-	-	-	-	1.60 %	0.05 %	
Allianz Strategy4Life 50	A/AT	5.00 %	-	5.00 %	-	-	-	-	1.80 %	0.05 %
	C/CT	5.00 %	-	5.00 %	-	-	-	-	2.00 %	0.05 %
	I/IT	-	-	-	-	-	-	-	1.60 %	0.01 %
	N/NT	-	-	-	-	-	-	-	1.50 %	0.05 %
	P/PT	2.00 %	-	2.00 %	-	-	-	-	1.60 %	0.05 %
	R/RT	-	-	-	-	-	-	-	1.70 %	0.05 %
	S/ST	7.00 %	-	7.00 %	-	-	-	-	1.50 %	0.05 %
	W/WT	-	-	-	-	-	-	-	0.60 %	0.01 %
	X/XT	-	-	-	-	-	-	-	0.30 %	0.01 %
Y/YT	-	-	-	-	-	-	-	1.60 %	0.05 %	
Allianz Strategy4Life 75	A/AT	5.00 %	-	5.00 %	-	-	-	-	1.80 %	0.05 %
	C/CT	5.00 %	-	5.00 %	-	-	-	-	2.00 %	0.05 %
	I/IT	-	-	-	-	-	-	-	1.60 %	0.01 %
	N/NT	-	-	-	-	-	-	-	1.50 %	0.05 %
	P/PT	2.00 %	-	2.00 %	-	-	-	-	1.60 %	0.05 %
	R/RT	-	-	-	-	-	-	-	1.70 %	0.05 %
	S/ST	7.00 %	-	7.00 %	-	-	-	-	1.50 %	0.05 %
	W/WT	-	-	-	-	-	-	-	0.60 %	0.01 %
	X/XT	-	-	-	-	-	-	-	0.30 %	0.01 %
Y/YT	-	-	-	-	-	-	-	1.60 %	0.05 %	
Allianz Strategy4Life Europe 40	A/AT	5.00 %	-	5.00 %	-	-	-	-	1.80 %	0.05 %
	C/CT	5.00 %	-	5.00 %	-	-	-	-	2.00 %	0.05 %
	I/IT	-	-	-	-	-	-	-	1.60 %	0.01 %
	N/NT	-	-	-	-	-	-	-	1.50 %	0.05 %
	P/PT	2.00 %	-	2.00 %	-	-	-	-	1.60 %	0.05 %
	R/RT	-	-	-	-	-	-	-	1.70 %	0.05 %
	S/ST	7.00 %	-	7.00 %	-	-	-	-	1.50 %	0.05 %
	W/WT	-	-	-	-	-	-	-	0.60 %	0.01 %
	X/XT	-	-	-	-	-	-	-	0.30 %	0.01 %
Y/YT	-	-	-	-	-	-	-	1.60 %	0.05 %	
Allianz Sustainable Health Evolution	A/AT	5.00 %	-	5.00 %	-	-	-	-	2.35 %	0.05 %
	C/CT	-	-	-	-	-	-	-	3.10 %	0.05 %
	I/IT	2.00 %	-	2.00 %	-	-	-	-	1.38 %	0.01 %
	P/PT	-	-	-	-	-	-	-	1.38 %	0.05 %
	R/RT	-	-	-	-	-	-	-	1.48 %	0.05 %
	W/WT	-	-	-	-	-	-	-	1.03 %	0.01 %
Allianz Sustainable Multi Asset 75	A/AT	5.00 %	-	5.00 %	-	-	-	-	1.85 %	0.05 %
	C/CT	5.00 %	-	5.00 %	-	-	-	-	2.40 %	0.05 %
	I/IT	2.00 %	-	2.00 %	-	-	-	-	0.87 %	0.01 %
	P/PT	2.00 %	-	2.00 %	-	-	-	-	1.70 %	0.05 %
	R/RT	-	-	-	-	-	-	-	1.70 %	0.05 %
	W/WT	-	-	-	-	-	-	-	0.60 %	0.01 %
Allianz Systematic Enhanced US Equity SRI	A/AT	5.00 %	-	5.00 %	-	-	-	-	1.30 %	0.05 %
	C/CT	5.00 %	-	5.00 %	-	-	-	-	2.05 %	0.05 %
	I/IT	2.00 %	-	2.00 %	-	-	-	-	0.70 %	0.01 %
	N/NT	-	-	-	-	-	-	-	1.08 %	0.05 %
	P/PT	2.00 %	-	2.00 %	-	-	-	-	1.08 %	0.05 %
	R/RT	-	-	-	-	-	-	-	1.30 %	0.05 %
	W/WT	-	-	-	-	-	-	-	0.50 %	0.01 %
	X/XT	-	-	-	-	-	-	-	1.08 %	0.01 %
Y/YT	-	-	-	-	-	-	-	0.70 %	0.05 %	

Sub-Fund Name	Share Class	Sales Charge	Placement Fee	Conversion Fee	Redemption Fee	Disinvestment Fee	Exit Fee	CDSC	All-in-Fee (p.a.)	Taxe d' Abonnement (p.a.)
Allianz Target Maturity Euro Bond I	A/AT	5.00 %	-	5.00 %	-	2.00 %	-	-	1.05 %	0.05 %
	C/CT	5.00 %	-	5.00 %	-	2.00 %	-	-	1.75 %	0.05 %
	I/IT	2.00 %	-	2.00 %	-	2.00 %	-	-	0.68 %	0.01 %
	N/NT	-	-	-	-	2.00 %	-	-	0.55 %	0.05 %
	P/PT	2.00 %	-	2.00 %	-	2.00 %	-	-	0.68 %	0.05 %
	R/RT	-	-	-	-	2.00 %	-	-	0.72 %	0.05 %
	S/ST	-	-	-	-	2.00 %	-	-	0.72 %	0.05 %
	W/WT	-	-	-	-	2.00 %	-	-	0.55 %	0.01 %
	X/XT	-	-	-	-	2.00 %	-	-	0.48 %	0.01 %
Allianz Target Maturity Euro Bond II	A/AT	2.00 %	-	2.00 %	-	2.00 %	-	-	0.85 %	0.05 %
	A2/AT2	-	2.00 %	-	-	2.00 % ^{*)}	2.00 %	-	0.85 %	0.05 %
	C/CT	2.00 %	-	2.00 %	-	2.00 %	-	-	1.20 %	0.05 %
	C6/CT6	-	2.00 %	-	-	2.00 %	2.00 %	-	1.20 %	0.05 %
	I/IT	2.00 %	-	2.00 %	-	2.00 %	-	-	0.46 %	0.01 %
	N/NT	-	-	-	-	2.00 %	-	-	0.32 %	0.05 %
	P/PT	2.00 %	-	2.00 %	-	2.00 %	-	-	0.46 %	0.05 %
	R/RT	-	-	-	-	2.00 %	-	-	0.50 %	0.05 %
	S/ST	-	-	-	-	2.00 %	-	-	0.50 %	0.05 %
	W/WT	-	-	-	-	2.00 %	-	-	0.32 %	0.01 %
	W6/WT6	-	2.00 %	-	-	2.00 %	2.00 %	-	0.32 %	0.01 %
	X/XT	-	-	-	-	2.00 %	-	-	0.28 %	0.01 %
Allianz Thematica	A/AT	5.00 %	-	5.00 %	-	-	-	-	2.05 %	0.05 %
	B/BT	-	-	5.00 %	-	-	-	3.00 %	3.05 %	0.05 %
	C/CT	5.00 %	-	5.00 %	-	-	-	-	2.80 %	0.05 %
	C2/CT2/C3/CT3	-	-	2.00 %	2.00 %	-	-	-	2.05 %	0.05 %
	E/ET	-	-	-	-	-	-	-	1.65 %	0.05 %
	I/IT	2.00 %	-	2.00 %	-	-	-	-	1.50 %	0.01 %
	N/NT	-	-	-	-	-	-	-	1.50 %	0.05 %
	P/PT	2.00 %	-	2.00 %	-	-	-	-	1.50 %	0.05 %
	R/RT	-	-	-	-	-	-	-	1.60 %	0.05 %
	S/ST	7.00 %	-	7.00 %	-	-	-	-	1.50 %	0.05 %
	W/WT	-	-	-	-	-	-	-	1.50 %	0.01 %
	X/XT	-	-	-	-	-	-	-	1.50 %	0.01 %
	Y/YT	-	-	-	-	-	-	-	1.50 %	0.05 %
Allianz Total Return Asian Equity	A/AT	5.00 %	-	5.00 %	-	-	-	-	2.05 %	0.05 %
	C/CT	5.00 %	-	5.00 %	-	-	-	-	2.80 %	0.05 %
	I/IT	-	-	-	-	-	-	-	1.53 %	0.01 %
	N/NT	-	-	-	-	-	-	-	1.53 %	0.05 %
	P/PT	-	-	-	-	-	-	-	1.08 %	0.05 %
	P8/PT8/P9/PT9	2.00 %	-	2.00 %	-	-	-	-	1.26 %	0.05 %
	R/RT	-	-	-	-	-	-	-	1.60 %	0.05 %
	S/ST	7.00 %	-	7.00 %	-	-	-	-	1.84 %	0.05 %
	W/WT	-	-	-	-	-	-	-	1.53 %	0.01 %
	X/XT	-	-	-	-	-	-	-	1.53 %	0.01 %
Y/YT	-	-	-	-	-	-	-	1.53 %	0.05 %	
Allianz Treasury Short Term Plus Euro	A/AT	2.00 %	-	2.00 %	-	-	-	-	1.15 %	0.05 %
	C/CT	2.00 %	-	2.00 %	-	-	-	-	1.40 %	0.05 %
	I/IT	1.00 %	-	1.00 %	-	-	-	-	0.41 %	0.01 %
	N/NT	-	-	-	-	-	-	-	0.84 %	0.05 %
	P/PT	1.00 %	-	1.00 %	-	-	-	-	0.84 %	0.05 %
	R/RT	-	-	-	-	-	-	-	0.90 %	0.05 %
	S/ST	4.00 %	-	4.00 %	-	-	-	-	1.01 %	0.05 %
	W/WT	-	-	-	-	-	-	-	0.84 %	0.01 %
	X/XT	-	-	-	-	-	-	-	0.84 %	0.01 %
	Y/YT	-	-	-	-	-	-	-	0.41 %	0.05 %
Allianz Trend and Brands	A/AT	4.00 %	-	4.00 %	-	-	-	-	1.50 %	0.05 %
	C/CT	-	3.50 %	-	-	-	3.50 %	-	2.25 %	0.05 %
	I/IT	2.00 %	-	2.00 %	-	-	-	-	1.00 %	0.01 %
	N/NT	-	-	-	-	-	-	-	1.00 %	0.05 %
	P/PT	2.00 %	-	2.00 %	-	-	-	-	1.00 %	0.05 %
	R/RT	-	-	-	-	-	-	-	1.00 %	0.05 %
	S/ST	7.00 %	-	7.00 %	-	-	-	-	1.00 %	0.05 %
	W/WT	-	-	-	-	-	-	-	0.80 %	0.01 %
	W6/WT6	-	3.50 %	-	-	-	3.50 %	-	0.80 %	0.01 %
	X/XT	-	-	-	-	-	-	-	0.70 %	0.01 %

- Allianz Global Investors Fund -

Sub-Fund Name	Share Class	Sales Charge	Placement Fee	Conversion Fee	Redemption Fee	Disinvestment Fee	Exit Fee	CDSC	All-in-Fee (p.a.)	Taxe d' Abonnement (p.a.)
Allianz UK Government Bond	A/AT	3.00 %	-	3.00 %	-	-	-	-	0.90 %	0.05 %
	I/IT	2.00 %	-	2.00 %	-	-	-	-	0.60 %	0.01 %
	P/PT	-	-	-	-	-	-	-	0.60 %	0.05 %
	R/RT	-	-	-	-	-	-	-	0.60 %	0.05 %
	W/WT	-	-	-	-	-	-	-	0.50 %	0.01 %
Allianz Unconstrained Multi Asset Strategy	A/AT	4.00 %	-	4.00 %	-	-	-	-	1.50 %	0.05 %
	A13/AT13	-	-	-	-	-	-	-	0.45 %	0.05 %
	C/CT	4.00 %	-	4.00 %	-	-	-	-	1.75 %	0.05 %
	D/DT	-	-	-	-	-	-	-	0.45 %	0.05 %
	F/FT	-	-	-	-	-	-	-	1.50 %	0.01 %
	I/IT	-	-	-	-	-	-	-	1.50 %	0.01 %
	I2/IT2	-	-	-	-	-	-	-	0.89 %	0.01 %
	I4 (EUR)	-	-	-	-	-	-	-	0.58 %	0.01 %
	P/PT	-	-	-	-	-	-	-	1.50 %	0.05 %
	R/RT	-	-	-	-	-	-	-	1.60 %	0.05 %
	X/XT	-	-	-	-	-	-	-	1.50 %	0.01 %
Y/YT	-	-	-	-	-	-	-	1.50 %	0.05 %	
Allianz US Equity Fund	A/AT	5.00 %	-	5.00 %	-	-	-	-	1.80 %	0.05 %
	C/CT	5.00 %	-	5.00 %	-	-	-	-	2.55 %	0.05 %
	I/IT	2.00 %	-	2.00 %	-	-	-	-	1.38 %	0.01 %
	N/NT	-	-	-	-	-	-	-	0.65 %	0.05 %
	P/PT	2.00 %	-	2.00 %	-	-	-	-	0.95 %	0.05 %
	P2/PT2	-	-	-	-	-	-	-	0.65 %	0.05 %
	R/RT	-	-	-	-	-	-	-	1.45 %	0.05 %
	S/ST	7.00 %	-	7.00 %	-	-	-	-	1.65 %	0.05 %
	W/WT	-	-	-	-	-	-	-	0.65 %	0.01 %
	X/XT	-	-	-	-	-	-	-	1.38 %	0.01 %
Y/YT	-	-	-	-	-	-	-	1.38 %	0.05 %	
Allianz US Equity Plus	A/AT	5.00 %	-	5.00 %	-	-	-	-	1.80 %	0.05 %
	B/BT	-	-	5.00 %	-	-	-	3.00 %	2.80 %	0.05 %
	C/CT	5.00 %	-	5.00 %	-	-	-	-	2.30 %	0.05 %
	I/IT	2.00 %	-	2.00 %	-	-	-	-	1.50 %	0.01 %
	N/NT	-	-	-	-	-	-	-	1.50 %	0.05 %
	P/PT	2.00 %	-	2.00 %	-	-	-	-	1.50 %	0.05 %
	R/RT	-	-	-	-	-	-	-	1.70 %	0.05 %
	S/ST	7.00 %	-	7.00 %	-	-	-	-	1.50 %	0.05 %
	W/WT	-	-	-	-	-	-	-	1.50 %	0.01 %
	X/XT	-	-	-	-	-	-	-	1.10 %	0.01 %
Y/YT	-	-	-	-	-	-	-	1.50 %	0.05 %	
Allianz US Equity powered by Artificial Intelligence	A/AT	5.00 %	-	5.00 %	-	-	-	-	1.60 %	0.05 %
	C/CT	5.00 %	-	5.00 %	-	-	-	-	2.25 %	0.05 %
	E/ET	-	-	-	-	-	-	-	1.60 %	0.05 %
	I/IT	2.00 %	-	2.00 %	-	-	-	-	1.20 %	0.01 %
	P/PT	2.00 %	-	2.00 %	-	-	-	-	1.20 %	0.05 %
	R/RT	-	-	-	-	-	-	-	1.30 %	0.05 %
	W/WT	-	-	-	-	-	-	-	0.80 %	0.01 %
	X/XT	-	-	-	-	-	-	-	0.80 %	0.01 %
Y/YT	-	-	-	-	-	-	-	0.80 %	0.05 %	
Allianz US High Yield	A/AT	5.00 %	-	5.00 %	-	-	-	-	1.39 %	0.05 %
	B/BT	-	-	5.00 %	-	-	-	3.00 %	2.39 %	0.05 %
	C/CT	5.00 %	-	5.00 %	-	-	-	-	2.39 %	0.05 %
	I/IT	2.00 %	-	2.00 %	-	-	-	-	0.75 %	0.01 %
	N/NT	-	-	-	-	-	-	-	1.02 %	0.05 %
	P/PT	2.00 %	-	2.00 %	-	-	-	-	0.75 %	0.05 %
	P8/PT8/P9/PT9	2.00 %	-	2.00 %	-	-	-	-	0.87 %	0.05 %
	R/RT	-	-	-	-	-	-	-	1.10 %	0.05 %
	S/ST	7.00 %	-	7.00 %	-	-	-	-	1.23 %	0.05 %
	W/WT	-	-	-	-	-	-	-	0.55 %	0.01 %
	X/XT	-	-	-	-	-	-	-	1.02 %	0.01 %
Y/YT	-	-	-	-	-	-	-	0.75 %	0.05 %	

- Allianz Global Investors Fund -

Sub-Fund Name	Share Class	Sales Charge	Placement Fee	Conversion Fee	Redemption Fee	Disinvestment Fee	Exit Fee	CDSC	All-in-Fee (p.a.)	Taxe d' Abonnement (p.a.)
Allianz US Investment Grade Credit	A/AT	5.00 %	-	5.00 %	-	-	-	-	1.10 %	0.05 %
	C/CT	5.00 %	-	5.00 %	-	-	-	-	1.80 %	0.05 %
	I/IT	2.00 %	-	2.00 %	-	-	-	-	0.71 %	0.01 %
	N/NT	-	-	-	-	-	-	-	0.56 %	0.05 %
	P/PT	2.00 %	-	2.00 %	-	-	-	-	0.71 %	0.05 %
	R/RT	-	-	-	-	-	-	-	0.75 %	0.05 %
	S/ST	-	-	-	-	-	-	-	0.75 %	0.05 %
	W/WT	-	-	-	-	-	-	-	0.56 %	0.01 %
	X/XT	-	-	-	-	-	-	-	0.49 %	0.01 %
Y/YT	-	-	-	-	-	-	-	0.52 %	0.05 %	
Allianz US Large Cap Value	A/AT	5.00 %	-	5.00 %	-	-	-	-	2.10 %	0.05 %
	C/CT	5.00 %	-	5.00 %	-	-	-	-	2.80 %	0.05 %
	I/IT	2.00 %	-	2.00 %	-	-	-	-	1.25 %	0.01 %
	N/NT	-	-	-	-	-	-	-	0.95 %	0.05 %
	P/PT	2.00 %	-	2.00 %	-	-	-	-	1.25 %	0.05 %
	R/RT	-	-	-	-	-	-	-	1.35 %	0.05 %
	S/ST	-	-	-	-	-	-	-	1.35 %	0.05 %
	W/WT	-	-	-	-	-	-	-	0.95 %	0.01 %
	X/XT	-	-	-	-	-	-	-	0.80 %	0.01 %
Y/YT	-	-	-	-	-	-	-	0.86 %	0.05 %	
Allianz US Short Duration High Income Bond	A/AT	5.00 %	-	5.00 %	-	-	-	-	1.29 %	0.05 %
	B/BT	-	-	5.00 %	-	-	-	3.00 %	2.29 %	0.05 %
	C/CT	5.00 %	-	5.00 %	-	-	-	-	2.75 %	0.05 %
	I/IT	2.00 %	-	2.00 %	-	-	-	-	0.70 %	0.01 %
	N/NT	-	-	-	-	-	-	-	1.45 %	0.05 %
	P/PT	2.00 %	-	2.00 %	-	-	-	-	1.45 %	0.05 %
	R/RT	-	-	-	-	-	-	-	1.70 %	0.05 %
	S/ST	5.00 %	-	5.00 %	-	-	-	-	1.45 %	0.05 %
	W/WT	-	-	-	-	-	-	-	1.45 %	0.01 %
X/XT	-	-	-	-	-	-	-	1.45 %	0.01 %	
Y/YT	-	-	-	-	-	-	-	0.70 %	0.05 %	
Allianz Volatility Strategy Fund	A/AT	6.00 %	-	6.00 %	-	-	-	-	2.30 %	0.05 %
	C/CT	3.00 %	-	3.00 %	-	-	-	-	2.80 %	0.05 %
	I/IT	-	-	-	-	-	-	-	1.00 %	0.01 %
	N/NT	-	-	-	-	-	-	-	1.50 %	0.05 %
	P/PT	-	-	-	-	-	-	-	1.00 %	0.05 %
	P2/PT2	3.00 %	-	3.00 %	-	-	-	-	1.50 %	0.05 %
	R/RT	-	-	-	-	-	-	-	2.00 %	0.05 %
	S/ST	7.00 %	-	7.00 %	-	-	-	-	1.50 %	0.05 %
	W/WT	-	-	-	-	-	-	-	1.50 %	0.01 %
X/XT	-	-	-	-	-	-	-	1.50 %	0.01 %	
Y/YT	-	-	-	-	-	-	-	1.00 %	0.05 %	
IndexManagement Balance	A/AT	5.00 %	-	5.00 %	-	-	-	-	1.20 %	0.05 %
	C/CT	5.00 %	-	5.00 %	-	-	-	-	1.65 %	0.05 %
	I/IT	2.00 %	-	2.00 %	-	-	-	-	0.84 %	0.01 %
	N/NT	-	-	-	-	-	-	-	0.69 %	0.05 %
	P/PT	2.00 %	-	2.00 %	-	-	-	-	0.85 %	0.05 %
	R/RT	-	-	-	-	-	-	-	1.00 %	0.05 %
	S/ST	7.00 %	-	7.00 %	-	-	-	-	0.85 %	0.05 %
	W/WT	-	-	-	-	-	-	-	0.68 %	0.01 %
	X/XT	-	-	-	-	-	-	-	0.50 %	0.01 %
Y/YT	-	-	-	-	-	-	-	0.84 %	0.05 %	
IndexManagement Chance	A/AT	5.00 %	-	5.00 %	-	-	-	-	1.20 %	0.05 %
	C/CT	5.00 %	-	5.00 %	-	-	-	-	1.65 %	0.05 %
	I/IT	2.00 %	-	2.00 %	-	-	-	-	0.84 %	0.01 %
	N/NT	-	-	-	-	-	-	-	0.69 %	0.05 %
	P/PT	2.00 %	-	2.00 %	-	-	-	-	0.85 %	0.05 %
	R/RT	-	-	-	-	-	-	-	1.00 %	0.05 %
	S/ST	7.00 %	-	7.00 %	-	-	-	-	0.85 %	0.05 %
	W/WT	-	-	-	-	-	-	-	0.68 %	0.01 %
	X/XT	-	-	-	-	-	-	-	0.50 %	0.01 %
Y/YT	-	-	-	-	-	-	-	0.84 %	0.05 %	

Sub-Fund Name	Share Class	Sales Charge	Placement Fee	Conversion Fee	Redemption Fee	Disinvestment Fee	Exit Fee	CDSC	All-in-Fee (p.a.)	Taxe d' Abonnement (p.a.)
IndexManagement Substanz	A/AT	5.00 %	-	5.00 %	-	-	-	-	1.20 %	0.05 %
	C/CT	5.00 %	-	5.00 %	-	-	-	-	1.65 %	0.05 %
	I/IT	2.00 %	-	2.00 %	-	-	-	-	0.84 %	0.01 %
	N/NT	-	-	-	-	-	-	-	0.69 %	0.05 %
	P/PT	2.00 %	-	2.00 %	-	-	-	-	0.85 %	0.05 %
	R/RT	-	-	-	-	-	-	-	1.00 %	0.05 %
	S/ST	7.00 %	-	7.00 %	-	-	-	-	0.85 %	0.05 %
	W/WT	-	-	-	-	-	-	-	0.68 %	0.01 %
	X/XT	-	-	-	-	-	-	-	0.50 %	0.01 %
Y/YT	-	-	-	-	-	-	-	0.84 %	0.05 %	
IndexManagement Wachstum	A/AT	5.00 %	-	5.00 %	-	-	-	-	1.20 %	0.05 %
	C/CT	5.00 %	-	5.00 %	-	-	-	-	1.65 %	0.05 %
	I/IT	2.00 %	-	2.00 %	-	-	-	-	0.84 %	0.01 %
	N/NT	-	-	-	-	-	-	-	0.69 %	0.05 %
	P/PT	2.00 %	-	2.00 %	-	-	-	-	0.85 %	0.05 %
	R/RT	-	-	-	-	-	-	-	1.00 %	0.05 %
	S/ST	7.00 %	-	7.00 %	-	-	-	-	0.85 %	0.05 %
	W/WT	-	-	-	-	-	-	-	0.68 %	0.01 %
	X/XT	-	-	-	-	-	-	-	0.50 %	0.01 %
Y/YT	-	-	-	-	-	-	-	0.84 %	0.05 %	

- ^{*)} For this Sub-Fund, the Company will reduce its share of the All-in Fee for part of the Sub-Fund which is invested in UCITS or UCI which are directly or indirectly managed by the Management Company or by another company with which the Management Company is linked by common management or control, or by a substantial direct or indirect participation by the respective actual calculated fixed management fee of the UCITS or UCI acquired. However, a decrease does not occur with respect to such linked UCITS or UCI as far as a reimbursement of this actually calculated fixed management fee is made in favor of this Sub-Fund.

Part B

Performance Fee

The following notes apply only to Sub-Funds that may charge a Performance Fee:

- The respective benchmark for the Performance Fee as well as the calculation method are mentioned for every Sub-Fund.
- Only Share Classes with a name affix in which the second digit is either 3, 4 or 5 may incur a performance fee.
- In case a Share Class is hedged against a certain currency, the respective benchmark is also hedged in the respective currency.

Sub-Funds that may charge a Performance Fee, Respective Benchmark and Calculation Method

Sub-Fund Name	Benchmark	Method
Allianz Advanced Fixed Income Euro	BLOOMBERG Euro Aggregate 1-10 Year Total Return	A
Allianz Advanced Fixed Income Global	J.P. MORGAN Government Bond (GBI) 1-10 Year	A
Allianz Advanced Fixed Income Global Aggregate	BLOOMBERG Global Aggregate 500 Excl. CNY Total Return	A
Allianz Advanced Fixed Income Short Duration	BLOOMBERG Euro-Aggregate: 1-3 Year Total Return	A
Allianz All China Equity	MSCI China All Shares Total Return Net	A
Allianz Alternative Investment Strategies	EURO SHORT-TERM RATE (€STR)	B
Allianz Asian Small Cap Equity	MSCI AC Asia Excl.-Japan Small Cap Total Return Net	A
Allianz Best Styles Euroland Equity	MSCI EMU Total Return Net	A
Allianz Best Styles Europe Equity	MSCI Europe Total Return Net	A
Allianz Best Styles Europe Equity SRI	MSCI Europe Ext.SRI 5% Issuer Capped Total Return Net	A
Allianz Best Styles Global AC Equity	MSCI AC World (ACWI) Total Return Net	A
Allianz Best Styles Global Equity	MSCI World Total Return Net	A
Allianz Best Styles Global Equity SRI	MSCI World Ext.SRI 5% Issuer Capped Total Return Net	A
Allianz Best Styles US Equity	S&P 500 Total Return Net	A
Allianz Blockchain Opportunities	50% MSCI ACWI SMID Cap Net Total Return USD Index + 50% Nasdaq Blockchain Economy Net Total Return Index	A
Allianz Capital Plus	70% BLOOMBERG Euro Aggregate 1-10 Year Total Return + 30% MSCI Europe Total Return Net	A
Allianz Capital Plus Global	70% BLOOMBERG Global Aggregate 500 Excl. CNY Total Return + 30% MSCI AC World (ACWI) Total Return Net	A
Allianz China A Opportunities	MSCI China A Total Return Net	A
Allianz China A-Shares	MSCI China A Onshore Total Return Net	A
Allianz China Equity	MSCI China 10/40 Total Return Net	A
Allianz China Thematica	MSCI China All Shares Total Return Net	A
Allianz Clean Planet	MSCI AC World (ACWI) Total Return Net	A
Allianz Climate Transition	MSCI Europe Total Return Net	A
Allianz Convertible Bond	Refinitiv Europe Focus CB (EUR)	A
Allianz Credit Opportunities	EURO SHORT-TERM RATE (€STR) p.a.	B
Allianz Credit Opportunities Plus	EURO SHORT-TERM RATE (€STR) p.a.	B

Sub-Fund Name	Benchmark	Method
Allianz Cyber Security	MSCI AC World (ACWI) Information Technology Total Return Net	A
Allianz Dynamic Allocation Plus Equity	MSCI World Total Return Net	A
Allianz Dynamic Asian High Yield Bond	J.P. MORGAN JACI Non-Investment Grade Custom Index	A
Allianz Emerging Asia Equity	MSCI Emerging Frontier Markets Asia Total Return Net	A
Allianz Emerging Europe Equity	MSCI Emerging Markets Europe 10-40 Total Return Net	A
Allianz Emerging Markets Equity	MSCI Emerging Markets Total Return Net	A
Allianz Emerging Markets Equity Opportunities	MSCI Emerging Markets Total Return Net	A
Allianz Emerging Markets Equity SRI	MSCI Emerging Markets Ext. SRI 5% Issuer Capped Total Return Net	A
Allianz Emerging Markets Select Bond	J.P. MORGAN Emerging Markets Blended (JEMB) Equal Weighted Total Return	A
Allianz Emerging Markets Short Duration Bond	SECURED OVERNIGHT FINANCING RATE (SOFR)	B
Allianz Emerging Markets Sovereign Bond	J.P. MORGAN Emerging Market Bond (EMBI) Global Diversified	A
Allianz Emerging Markets SRI Bond	J.P. MORGAN ESG Emerging Market Bond (EMBI) Global Diversified Total Return	A
Allianz Emerging Markets SRI Corporate Bond	J.P. MORGAN ESG Corporate Emerging Market Bond (CEMBI) Broad Diversified Total Return	A
Allianz Enhanced All China Equity	MSCI China All Shares Total Return Net	A
Allianz Enhanced Short Term Euro	EURO SHORT-TERM RATE (€STR)	B
Allianz Euro Balanced	50% IBOXX EUR Sovereigns Eurozone Total Return + 50% MSCI EMU Total Return Net	A
Allianz Euro Bond	BLOOMBERG Euro-Aggregate Total Return	A
Allianz Euro Bond Short Term 1-3 Plus	J.P. MORGAN EMU Bond 1-3 Year	A
Allianz Euro Credit SRI	ICE BOFAML Euro Corporate Index (ICE Indices incorporate transaction costs into their calculation)	A
Allianz Euro Government Bond	IBOXX EUR Sovereigns Eurozone Total Return	A
Allianz Euro High Yield Bond	ICE BOFAML Euro High Yield BB-B Constrained (ICE Indices incorporate transaction costs into their calculation)	A
Allianz Euro High Yield Defensive	ICE BOFAML Euro Non-Financial High Yield BB-B Constrained (ICE Indices incorporate transaction costs into their calculation)	A
Allianz Euro Inflation-linked Bond	BLOOMBERG Euro Government Inflation-Linked Bond Total Return	A
Allianz Europe Equity Growth	S&P Europe Large Mid Cap Growth Total Return Net	A
Allianz Europe Equity Growth Select	S&P Europe Large Cap Growth Total Return Net	A
Allianz Europe Equity powered by Artificial Intelligence	MSCI Europe Total Return Net	A
Allianz Europe Equity SRI	MSCI Europe Total Return Net	A
Allianz Europe Equity Value	S&P Europe Large Mid Cap Value Total Return Net	A
Allianz Europe Mid Cap Equity	MSCI Europe Mid Cap Total Return Net	A
Allianz Europe Small Cap Equity	MSCI Europe Small Cap Total Return Net	A
Allianz Fixed Income Macro	SONIA	B
Allianz Flexi Asia Bond	J.P. MORGAN JACI Composite Total Return	A

Sub-Fund Name	Benchmark	Method
Allianz Floating Rate Notes Plus	EURO SHORT-TERM RATE (€STR)	B
Allianz Food Security	MSCI AC World (ACWI) Total Return Net	A
Allianz German Equity	DAX	A
Allianz German Small and Micro Cap	SDAX Total Return Gross	A
Allianz Global Aggregate Bond	BLOOMBERG Global Aggregate Total Return	A
Allianz Global Diversified Dividend	MSCI World High Dividend Yield Net Return EUR Index	A
Allianz Global Equity powered by Artificial Intelligence	MSCI World Total Return Net	A
Allianz Global Equity Unconstrained	MSCI AC World (ACWI) Total Return Net	A
Allianz Global Floating Rate Notes Plus	SECURED OVERNIGHT FINANCING RATE (SOFR)	B
Allianz Global Government Bond	FTSE World Government Bond (WGBI) Total Return	A
Allianz Global High Yield	ICE BOFAML Global High Yield Constrained (hedged) (ICE Indices incorporate transaction costs into their calculation)	A
Allianz Global Inflation-Linked Bond	BLOOMBERG World Government Inflation-Linked Bond Total Return	A
Allianz Global Intelligent Cities Income	70% MSCI AC World (ACWI) Total Return Net + 30% ICE BOFAML US Corporate & High Yield Index (ICE Indices incorporate transaction costs into their calculation)	A
Allianz Global Metals and Mining	MSCI ACWI Metals & Mining 30% Buffer 10/40	A
Allianz Global Multi-Asset Credit	SECURED OVERNIGHT FINANCING RATE (SOFR)	B
Allianz Global Multi-Asset Credit SRI	SECURED OVERNIGHT FINANCING RATE (SOFR)	B
Allianz Global Opportunistic Bond	Secured Overnight Financing Rate (SOFR)	B
Allianz Global Small Cap Equity	MSCI World Small Cap Total Return Net	A
Allianz Global Sustainability	DOW JONES Sustainability World Total Return Net	A
Allianz Global Water	MSCI AC World (ACWI) Total Return Net	A
Allianz Green Bond	ICE BOFAML Green Bond (hedged into EUR) (ICE Indices incorporate transaction costs into their calculation)	A
Allianz Hong Kong Equity	FTSE MPF Hong Kong Index Total Return Net	A
Allianz India Equity	MSCI India Total Return Net	A
Allianz Indonesia Equity	JAKARTA Composite	A
Allianz Japan Equity	TOPIX Total Return Net	A
Allianz Little Dragons	MSCI AC Asia Excl. Japan Mid Cap Total Return Net	A
Allianz Metaverse	50% MSCI AC World (ACWI) Total Return Net + 50% MSCI AC World (ACWI) Information Technology Total Return Net	A
Allianz Multi Asset Long / Short	SECURED OVERNIGHT FINANCING RATE (SOFR)	B
Allianz Multi Asset Opportunities	SECURED OVERNIGHT FINANCING RATE (SOFR)	B
Allianz Multi Asset Risk Premia	SECURED OVERNIGHT FINANCING RATE (SOFR)	B
Allianz Oriental Income	MSCI AC Asia Pacific Total Return Net	A
Allianz Pet and Animal Wellbeing	MSCI AC World (ACWI) Total Return Net	A
Allianz Positive Change	MSCI AC World (ACWI) Total Return Net	A
Allianz Premium Champions	MSCI AC World (ACWI) Total Return Net	A
Allianz SDG Euro Credit	BLOOMBERG Euro Aggregate Corporate Total Return	A

Sub-Fund Name	Benchmark	Method
Allianz SDG Global Equity	MSCI World Net Total Return	A
Allianz Selective Global High Income	ICE BOFAML BB-B Global High Yield Index (hedged) (ICE Indices incorporate transaction costs into their calculation)	B
Allianz Smart Energy	MSCI AC World (ACWI) Total Return Net	A
Allianz Strategic Bond	BLOOMBERG Global Aggregate Total Return (hedged into USD)	A
Allianz Sustainable Health Evolution	MSCI AC World (ACWI) Total Return Net	A
Allianz Systematic Enhanced US Equity SRI	MSCI USA ESG Screened Index	A
Allianz Thematica	MSCI AC World (ACWI) Total Return Net	A
Allianz Total Return Asian Equity	MSCI AC Asia Excl. Japan Total Return Net	A
Allianz Treasury Short Term Plus Euro	EURIBOR 3-Month	B
Allianz Unconstrained Multi Asset Strategy	EURO SHORT-TERM RATE (€STR)	B
Allianz US Equity Fund	S&P 500 Total Return	A
Allianz US Equity powered by Artificial Intelligence	S&P 500 Total Return Net	A
Allianz US Investment Grade Credit	Bloomberg US Corporate Total Return	A
Allianz US Large Cap Value	Russell 1000 Value Total Return Net	A
Allianz Volatility Strategy Fund	EURO SHORT-TERM RATE (€STR)	B

General Participation Rates applicable to all Sub-Funds that may charge a Performance Fee unless otherwise stated below

The Management Company has discretion to levy a lower Performance Fee at its own discretion.

Share Class / Name Affix	A/AT	13	14	15													
		30%	30%	30%													
Participation Rate	D/DT	13	14	15													
		-	-	-													
Share Class / Name Affix	R/RT	13	14	15													
		30%	30%	30%													
Participation Rate	I/IT	13	14	15	73	75											
		30%	30%	30%	30%	30%											
Participation Rate	P/PT	13	14	15	23	24	25	33	35	43	45	53	55	63	65	73	75
		30%	30%	30%	30%	30%	30%	30%	30%	30%	30%	30%	30%	30%	30%	30%	30%
Participation Rate	W/WT	13	14	15	23	25	33	35	43	45	53	55	63	65	93	95	
		30%	30%	30%	30%	30%	30%	30%	30%	30%	30%	30%	30%	30%	30%	30%	
Participation Rate	Y/YT	13	14	15													
		30%	30%	30%													

Sub-Fund-Specific Participation Rates on an Individual Basis

The Management Company has discretion to levy a lower Performance Fee at its own discretion.

Allianz Asian Small Cap Equity	A/AT	13	14	15														
		20%	20%	20%														
	D/DT	13	14	15														
		-	-	-														
	R/RT	13	14	15														
		20%	20%	20%														
	I/IT	13	14	15	73	75												
		20%	20%	20%	20%	20%												
Share Class / Name Affix	P/PT	13	14	15	23	24	25	33	35	43	45	53	55	63	65	73	75	
		20%	20%	20%	20%	20%	20%	20%	20%	20%	20%	20%	20%	20%	20%	30%	30%	
	W/WT	13	14	15	23	25	33	35	43	45	53	55	63	65	93	95		
		20%	20%	20%	20%	20%	20%	20%	20%	20%	20%	20%	30%	30%	20%	20%		
	Y/YT	13	14	15														
		30%	30%	30%														
	Allianz Multi Asset Long / Short	A/AT	13	14	15													
		25%	25%	25%														
D/DT		13	14	15														
		-	-	-														
R/RT		13	14	15														
		25%	25%	25%														
I/IT		13	14	15	73	75												
		25%	25%	25%	25%	25%												
Share Class / Name Affix	P/PT	13	14	15	23	24	25	33	35	43	45	53	55	63	65	73	75	
		25%	25%	25%	25%	25%	25%	25%	25%	25%	25%	25%	25%	25%	25%	30%	30%	
	W/WT	13	14	15	23	25	33	35	43	45	53	55	63	65	93	95		
		25%	25%	25%	25%	25%	25%	25%	25%	25%	25%	25%	30%	30%	25%	25%		
	Y/YT	13	14	15														
		30%	30%	30%														
	Allianz Unconstrained Multi Asset Strategy	A/AT	13	14	15													
		25%	25%	25%														
D/DT		13	14	15														
		25%	25%	25%														
R/RT		13	14	15														
		25%	25%	25%														
I/IT		13	14	15	73	75												
		25%	25%	25%	25%	25%												
Share Class / Name Affix	P/PT	13	14	15	23	24	25	33	35	43	45	53	55	63	65	73	75	
		25%	25%	25%	25%	25%	25%	25%	25%	25%	25%	25%	25%	25%	25%	30%	30%	
	W/WT	13	14	15	23	25	33	35	43	45	53	55	63	65	93	95		
		25%	25%	25%	25%	25%	25%	25%	25%	25%	25%	25%	30%	30%	25%	25%		
	Y/YT	13	14	15														
		30%	30%	30%														

Appendix 3

Sub-Fund Specific Characteristics

The following notes apply to all Sub-Funds:

- The column “Dealing Day / Valuation Day” refers to each day on which banks and exchanges in the countries and/or cities indicated are open for business. In case that a specific day indicated is not a day on which banks and exchanges in such countries and/or cities are open for business the next day on which banks and exchanges in such countries and/or cities are open for business shall be considered.
- Dealing Applications received by the respective account keeping entities, the Distributors, the Paying Agents or at the Registrar and Transfer Agent at the time indicated on any Dealing Day will be dealt with at the applicable Dealing Price determined (but not yet published) on such Dealing Day. Dealing Applications received after this time will be dealt with at the applicable Dealing Price on the next Dealing Day. Different deadlines for receipt of Dealing Applications may be applicable to individual Sub-Funds. Indications are made within the column “Trading Deadline” when exceptions apply.

Sub-Fund Name	Base Currency	Dealing Day / Valuation Day	Trading Deadline	Fair Value Pricing Model
Allianz ActiveInvest Balanced	EUR	Luxembourg / Germany	2.00 p.m. CET or CEST on any Dealing Day two Dealing Days in advance of a Dealing Day. Subscription and redemption applications received by 2.00 p.m. CET or CEST on any Dealing Day are settled at the Subscription or Redemption Price of the second Dealing Day following the Dealing Day. Subscription and redemption applications received after that time are settled at the Subscription or Redemption Price of the Dealing Day after the second Dealing Day following the Dealing Day.	–
Allianz ActiveInvest Defensive	EUR	Luxembourg / Germany	2.00 p.m. CET or CEST on any Dealing Day two Dealing Days in advance of a Dealing Day. Subscription and redemption applications received by 2.00 p.m. CET or CEST on any Dealing Day are settled at the Subscription or Redemption Price of the second Dealing Day following the Dealing Day. Subscription and redemption applications received after that time are settled at the Subscription or Redemption Price of the Dealing Day after the second Dealing Day following the Dealing Day.	–
Allianz ActiveInvest Dynamic	EUR	Luxembourg / Germany	2.00 p.m. CET or CEST on any Dealing Day two Dealing Days in advance of a Dealing Day. Subscription and redemption applications received by 2.00 p.m. CET or CEST on any Dealing Day are settled at the Subscription or Redemption Price of the second Dealing Day following the Dealing Day. Subscription and redemption applications received after that time are settled at the Subscription or Redemption Price of the Dealing Day after the second Dealing Day following the Dealing Day.	–
Allianz Advanced Fixed Income Euro	EUR	Luxembourg / Germany	11.00 a.m. CET or CEST on any Dealing Day.	–
Allianz Advanced Fixed Income Global	EUR	Luxembourg / Germany	11.00 a.m. CET or CEST on any Dealing Day.	–
Allianz Advanced Fixed Income Global Aggregate	EUR	Luxembourg / Germany	11.00 a.m. CET or CEST on any Dealing Day.	–
Allianz Advanced Fixed Income Short Duration	EUR	Luxembourg / Germany	11.00 a.m. CET or CEST on any Dealing Day.	–
Allianz All China Equity	USD	Luxembourg / Hong Kong / PRC (including Stock Connect Northbound Trading Days)	11.00 a.m. CET or CEST on any Dealing Day.	YES

Sub-Fund Name	Base Currency	Dealing Day / Valuation Day	Trading Deadline	Fair Value Pricing Model
Allianz Alternative Investment Strategies	EUR	Luxembourg / France / Germany	2.00 p.m. CET or CEST on any Dealing Day two Dealing Days in advance of a Dealing Day. Subscription and redemption applications received by 2.00 p.m. CET or CEST on any Dealing Day are settled at the Subscription or Redemption Price of the third Dealing Day following the Dealing Day. Subscription and redemption applications received after that time are settled at the Subscription or Redemption Price of the Dealing Day after the third Dealing Day following the Dealing Day.	-
Allianz American Income	USD	Luxembourg / United States	11.00 a.m. CET or CEST on any Dealing Day.	-
Allianz Asian Multi Income Plus	USD	Luxembourg / Hong Kong / Singapore	11.00 a.m. CET or CEST on any Dealing Day.	YES
Allianz Asian Small Cap Equity	USD	Luxembourg / Hong Kong	6.00 p.m. CET or CEST on any Dealing Day preceding a Dealing Day. Subscription and redemption applications received by 6.00 p.m. CET or CEST on any Dealing Day preceding a Dealing Day are settled at the Subscription or Redemption Price of the next Dealing Day. Subscription and redemption applications received after that time are settled at the Subscription or Redemption Price of the second Dealing Day following the Dealing Day.	-
Allianz Best Ideas 2025	EUR	Luxembourg / United States	11.00 a.m. CET or CEST on any Dealing Day.	YES
Allianz Best of Managers	EUR	Luxembourg / Germany	2.00 p.m. CET or CEST on any Dealing Day two Dealing Days in advance of a Dealing Day. Subscription and redemption applications received by 2.00 p.m. CET or CEST on any Dealing Day are settled at the Subscription or Redemption Price of the second Dealing Day following the Dealing Day. Subscription and redemption applications received after that time are settled at the Subscription or Redemption Price of the Dealing Day after the second Dealing Day following the Dealing Day.	-
Allianz Best Styles Euroland Equity	EUR	Luxembourg	11.00 a.m. CET or CEST on any Dealing Day.	-
Allianz Best Styles Europe Equity	EUR	Luxembourg / Germany	11.00 a.m. CET or CEST on any Dealing Day.	-
Allianz Best Styles Europe Equity SRI	EUR	Luxembourg / Germany	11.00 a.m. CET or CEST on any Dealing Day preceding a Dealing Day. Subscription and redemption applications received by 11.00 a.m. CET or CEST on any Dealing Day preceding a Dealing Day are settled at the Subscription or Redemption Price of the next Dealing Day. Subscription and redemption applications received after that time are settled at the Subscription or Redemption Price of the second Dealing Day following the Dealing Day.	-
Allianz Best Styles Global AC Equity	EUR	Luxembourg / Germany / United States	11.00 a.m. CET or CEST on any Dealing Day preceding a Dealing Day. Subscription and redemption applications received by 11.00 a.m. CET or CEST on any Dealing Day preceding a Dealing Day are settled at the Subscription or Redemption Price of the next Dealing Day. Subscription and redemption applications received after that time are settled at the Subscription or Redemption Price of the second Dealing Day following the Dealing Day.	-
Allianz Best Styles Global Equity	EUR	Luxembourg / Germany	11.00 a.m. CET or CEST on any Dealing Day.	YES

Sub-Fund Name	Base Currency	Dealing Day / Valuation Day	Trading Deadline	Fair Value Pricing Model
Allianz Best Styles Global Equity SRI	USD	Luxembourg / Germany / United States	11.00 a.m. CET or CEST on any Dealing Day preceding a Dealing Day. Subscription and redemption applications received by 11.00 a.m. CET or CEST on any Dealing Day preceding a Dealing Day are settled at the Subscription or Redemption Price of the next Dealing Day. Subscription and redemption applications received after that time are settled at the Subscription or Redemption Price of the second Dealing Day following the Dealing Day.	-
Allianz Best Styles Pacific Equity	EUR	Luxembourg / Germany / Japan	11.00 a.m. CET or CEST on any Dealing Day preceding a Dealing Day. Subscription and redemption applications received by 11.00 a.m. CET or CEST on any Dealing Day preceding a Dealing Day are settled at the Subscription or Redemption Price of the next Dealing Day. Subscription and redemption applications received after that time are settled at the Subscription or Redemption Price of the second Dealing Day following the Dealing Day.	-
Allianz Best Styles US Equity	USD	Luxembourg / Germany / United States	11.00 a.m. CET or CEST on any Dealing Day.	YES
Allianz Better World Defensive	EUR	Luxembourg / Germany / France	11.00 a.m. CET or CEST on any Dealing Day.	YES
Allianz Better World Dynamic	EUR	Luxembourg / Germany / France	11.00 a.m. CET or CEST on any Dealing Day.	YES
Allianz Better World Moderate	EUR	Luxembourg / Germany / France	11.00 a.m. CET or CEST on any Dealing Day.	YES
Allianz Blockchain Opportunities	USD	Luxembourg / United States	11.00 a.m. CET or CEST on any Dealing Day.	YES
Allianz Capital Plus	EUR	Luxembourg / Germany	11.00 a.m. CET or CEST on any Dealing Day.	-
Allianz Capital Plus Global	EUR	Luxembourg / Germany	11.00 a.m. CET or CEST on any Dealing Day.	YES
Allianz China A Opportunities	USD	Luxembourg / Hong Kong / PRC (including Stock Connect Northbound Trading Days)	11.00 a.m. CET or CEST on any Dealing Day.	YES
Allianz China A-Shares	USD	Luxembourg / Hong Kong / PRC (including Stock Connect Northbound Trading Days)	11.00 a.m. CET or CEST on any Dealing Day.	YES
Allianz China Equity	USD	Luxembourg / Hong Kong	11.00 a.m. CET or CEST on any Dealing Day.	YES
Allianz China Future Technologies	USD	Luxembourg / Hong Kong / PRC (including Stock Connect Northbound Trading Days)	11.00 a.m. CET or CEST on any Dealing Day	YES
Allianz China Healthy Living	USD	Luxembourg / Hong Kong / PRC (including Stock Connect Northbound Trading Days)	11.00 a.m. CET or CEST on any Dealing Day	YES
Allianz China Multi Income Plus	USD	Luxembourg / Hong Kong / Singapore	11.00 a.m. CET or CEST on any Dealing Day.	YES
Allianz China Strategic Bond	USD	Luxembourg / Singapore	11.00 a.m. CET or CEST on any Dealing Day.	-
Allianz China Thematica	USD	Luxembourg / Germany / Hong Kong / PRC (including Stock Connect Northbound Trading Days)	11.00 a.m. CET or CEST on any Dealing Day.	YES
Allianz Clean Planet	USD	Luxembourg / Germany / United States	11.00 a.m. CET or CEST on any Dealing Day.	YES
Allianz Climate Transition	EUR	Luxembourg / France / Germany	11.00 a.m. CET or CEST on any Dealing Day.	-

Sub-Fund Name	Base Currency	Dealing Day / Valuation Day	Trading Deadline	Fair Value Pricing Model
Allianz Convertible Bond	EUR	Luxembourg / France / United Kingdom	11.00 a.m. CET or CEST on any Dealing Day.	-
Allianz Coupon Select Plus V	EUR	Luxembourg / Germany	2.00 p.m. CET or CEST on any Dealing Day two Dealing Days in advance of a Dealing Day. Subscription and redemption applications received by 2.00 p.m. CET or CEST on any Dealing Day are settled at the Subscription or Redemption Price of the second Dealing Day following the Dealing Day. Subscription and redemption applications received after that time are settled at the Subscription or Redemption Price of the Dealing Day after the second Dealing Day following the Dealing Day.	-
Allianz Coupon Select Plus VI	EUR	Luxembourg / Germany	2.00 p.m. CET or CEST on any Dealing Day two Dealing Days in advance of a Dealing Day. Subscription and redemption applications received by 2.00 p.m. CET or CEST on any Dealing Day are settled at the Subscription or Redemption Price of the second Dealing Day following the Dealing Day. Subscription and redemption applications received after that time are settled at the Subscription or Redemption Price of the Dealing Day after the second Dealing Day following the Dealing Day.	-
Allianz Credit Opportunities	EUR	Luxembourg / France / United Kingdom	2.00 p.m. CET or CEST on any Dealing Day two Dealing Days in advance of a Dealing Day. Subscription and redemption applications received by 2.00 p.m. CET or CEST on any Dealing Day are settled at the Subscription or Redemption Price of the second Dealing Day following the Dealing Day. Subscription and redemption applications received after that time are settled at the Subscription or Redemption Price of the Dealing Day after the second Dealing Day following the Dealing Day.	-
Allianz Credit Opportunities Plus	EUR	Luxembourg / France / United Kingdom	2.00 p.m. CET or CEST on any Dealing Day two Dealing Days in advance of a Dealing Day. Subscription and redemption applications received by 2.00 p.m. CET or CEST on any Dealing Day are settled at the Subscription or Redemption Price of the second Dealing Day following the Dealing Day. Subscription and redemption applications received after that time are settled at the Subscription or Redemption Price of the Dealing Day after the second Dealing Day following the Dealing Day.	-
Allianz Cyber Security	USD	Luxembourg / United States	11.00 a.m. CET or CEST on any Dealing Day.	YES
Allianz Dynamic Allocation Plus Equity	USD	Luxembourg / Germany / United States	11.00 a.m. CET or CEST on any Dealing Day preceding a Dealing Day. Subscription and redemption applications received by 11.00 a.m. CET or CEST on any Dealing Day preceding a Dealing Day are settled at the Subscription or Redemption Price of the next Dealing Day. Subscription and redemption applications received after that time are settled at the Subscription or Redemption Price of the second Dealing Day following the Dealing Day.	-
Allianz Dynamic Asian High Yield Bond	USD	Luxembourg / Singapore	11.00 a.m. CET or CEST on any Dealing Day.	-
Allianz Dynamic Commodities	EUR (valid until 30 September 2023) / USD (valid as of 1 October 2023)	Luxembourg / Austria / United Kingdom / United States (major exchanges in the United States on which derivatives on the major Commodity Indexes or their sub-indices or commodity-related ETCs are traded)	11.00 a.m. CET or CEST on any Dealing Day two Dealing Days in advance of a Dealing Day. Subscription and redemption applications received by 11.00 a.m. CET or CEST on any Dealing Day are settled at the Subscription or Redemption Price of the second Dealing Day following the Dealing Day. Subscription and redemption applications received after that time are settled at the Subscription or Redemption Price of the Dealing Day after the second Dealing Day following the Dealing Day.	-

Sub-Fund Name	Base Currency	Dealing Day / Valuation Day	Trading Deadline	Fair Value Pricing Model
Allianz Dynamic Multi Asset Strategy SRI 15	EUR	Luxembourg / Germany / United States	6.00 p.m. CET or CEST on any Dealing Day preceding a Dealing Day. Subscription and redemption applications received by 6.00 p.m. CET or CEST on any Dealing Day preceding a Dealing Day are settled at the Subscription or Redemption Price of the next Dealing Day. Subscription and redemption applications received after that time are settled at the Subscription or Redemption Price of the second Dealing Day following the Dealing Day.	-
Allianz Dynamic Multi Asset Strategy SRI 50	EUR	Luxembourg / Germany / United States	6.00 p.m. CET or CEST on any Dealing Day preceding a Dealing Day. Subscription and redemption applications received by 6.00 p.m. CET or CEST on any Dealing Day preceding a Dealing Day are settled at the Subscription or Redemption Price of the next Dealing Day. Subscription and redemption applications received after that time are settled at the Subscription or Redemption Price of the second Dealing Day following the Dealing Day.	-
Allianz Dynamic Multi Asset Strategy SRI 75	EUR	Luxembourg / Germany / United States	6.00 p.m. CET or CEST on any Dealing Day preceding a Dealing Day. Subscription and redemption applications received by 6.00 p.m. CET or CEST on any Dealing Day preceding a Dealing Day are settled at the Subscription or Redemption Price of the next Dealing Day. Subscription and redemption applications received after that time are settled at the Subscription or Redemption Price of the second Dealing Day following the Dealing Day.	-
Allianz Emerging Asia Equity	USD	Luxembourg / Hong Kong	- 5.00 p.m. Hong Kong Time for applications for subscription or redemptions received by the Singapore registrar and/or transfer agent as appointed by Singapore Representative and Hong Kong Representative on any Dealing Day. - 10.00 a.m. CET or CEST for applications for subscription or redemptions received by other account keeping entities, the Distributors, the Paying Agent or at the Registrar and Transfer Agent on any Dealing Day.	YES
Allianz Emerging Europe Equity	EUR	Luxembourg / Germany	7.00 a.m. CET or CEST on any Dealing Day.	-
Allianz Emerging Markets Equity	USD	Luxembourg / Germany / United Kingdom	11.00 a.m. CET or CEST on any Dealing Day preceding a Dealing Day. Subscription and redemption applications received by 11.00 a.m. CET or CEST on any Dealing Day preceding a Dealing Day are settled at the Subscription or Redemption Price of the next Dealing Day. Subscription and redemption applications received after that time are settled at the Subscription or Redemption Price of the second Dealing Day following the Dealing Day.	-
Allianz Emerging Markets Equity Opportunities	EUR	Luxembourg / United States	11.00 a.m. CET or CEST on any Dealing Day.	YES
Allianz Emerging Markets Equity SRI	USD	Luxembourg / Germany / United Kingdom	11.00 a.m. CET or CEST on any Dealing Day preceding a Dealing Day. Subscription and redemption applications received by 11.00 a.m. CET or CEST on any Dealing Day preceding a Dealing Day are settled at the Subscription or Redemption Price of the next Dealing Day. Subscription and redemption applications received after that time are settled at the Subscription or Redemption Price of the second Dealing Day following the Dealing Day.	-
Allianz Emerging Markets Multi Asset Income	USD	Luxembourg / Hong Kong / United States	11.00 a.m. CET or CEST on any Dealing Day.	YES
Allianz Emerging Markets Select Bond	USD	Luxembourg / United Kingdom / United States	7.00 a.m. CET or CEST on any Dealing Day.	-

Sub-Fund Name	Base Currency	Dealing Day / Valuation Day	Trading Deadline	Fair Value Pricing Model
Allianz Emerging Markets Short Duration Bond	USD	Luxembourg / United Kingdom / United States	7.00 a.m. CET or CEST on any Dealing Day.	-
Allianz Emerging Markets Sovereign Bond	USD	Luxembourg / United Kingdom / United States	7.00 a.m. CET or CEST on any Dealing Day.	-
Allianz Emerging Markets SRI Bond	USD	Luxembourg / United Kingdom / United States	7.00 a.m. CET or CEST on any Dealing Day.	-
Allianz Emerging Markets SRI Corporate Bond	USD	Luxembourg / United Kingdom / United States	7.00 a.m. CET or CEST on any Dealing Day.	-
Allianz Enhanced All China Equity	USD	Luxembourg / Hong Kong / PRC (including Stock Connect Northbound Trading Days)	11.00 a.m. CET or CEST on any Dealing Day.	YES
Allianz Enhanced Short Term Euro	EUR	Luxembourg	11.00 a.m. CET or CEST on any Dealing Day.	-
Allianz Euro Balanced	EUR	Luxembourg / Germany / Netherlands	11.00 a.m. CET or CEST on any Dealing Day.	-
Allianz Euro Bond	EUR	Luxembourg / France / Italy	11.00 a.m. CET or CEST on any Dealing Day.	-
Allianz Euro Bond Short Term 1-3 Plus	EUR	Luxembourg / France / Germany	11.00 a.m. CET or CEST on any Dealing Day.	-
Allianz Euro Credit SRI	EUR	Luxembourg / France / United Kingdom	11.00 a.m. CET or CEST on any Dealing Day.	-
Allianz Euro Government Bond	EUR	Luxembourg	11.00 a.m. CET or CEST on any Dealing Day.	-
Allianz Euro High Yield Bond	EUR	Luxembourg / France / United Kingdom	11.00 a.m. CET or CEST on any Dealing Day.	-
Allianz Euro High Yield Defensive	EUR	Luxembourg / France / United Kingdom	11.00 a.m. CET or CEST on any Dealing Day.	-
Allianz Euro Inflation-linked Bond	EUR	Luxembourg / France	11.00 a.m. CET or CEST on any Dealing Day.	-
Allianz Euroland Equity Growth	EUR	Luxembourg	11.00 a.m. CET or CEST on any Dealing Day.	-
Allianz Europe Equity Growth	EUR	Luxembourg	11.00 a.m. CET or CEST on any Dealing Day.	-
Allianz Europe Equity Growth Select	EUR	Luxembourg / Germany	11.00 a.m. CET or CEST on any Dealing Day.	-
Allianz Europe Equity powered by Artificial Intelligence	EUR	Luxembourg / Germany	11.00 a.m. CET or CEST on any Dealing Day preceding a Dealing Day. Subscription and redemption applications received by 11.00 a.m. CET or CEST on any Dealing Day preceding a Dealing Day are settled at the Subscription or Redemption Price of the next Dealing Day. Subscription and redemption applications received after that time are settled at the Subscription or Redemption Price of the second Dealing Day following the Dealing Day.	-
Allianz Europe Equity SRI	EUR	Luxembourg / France	11.00 a.m. CET or CEST on any Dealing Day.	-
Allianz Europe Equity Value	EUR	Luxembourg / Germany	11.00 a.m. CET or CEST on any Dealing Day.	-
Allianz Europe Income and Growth	EUR	Luxembourg / France / Germany / United Kingdom	11.00 a.m. CET or CEST on any Dealing Day.	-
Allianz Europe Mid Cap Equity	EUR	Luxembourg / Germany	11.00 a.m. CET or CEST on any Dealing Day.	-
Allianz Europe Small and Micro Cap Equity	EUR	Luxembourg / Germany	11.00 a.m. CET or CEST on any Dealing Day.	-
Allianz Europe Small Cap Equity	EUR	Luxembourg	11.00 a.m. CET or CEST on any Dealing Day.	-
Allianz European Bond RC	EUR	Luxembourg / France	11.00 a.m. CET or CEST on any Dealing Day.	-
Allianz European Equity Dividend	EUR	Luxembourg	11.00 a.m. CET or CEST on any Dealing Day.	-

Sub-Fund Name	Base Currency	Dealing Day / Valuation Day	Trading Deadline	Fair Value Pricing Model
Allianz Fixed Income Macro	GBP	Luxembourg / United Kingdom	11.00 a.m. CET or CEST on any Dealing Day.	-
Allianz Flexi Asia Bond	USD	Luxembourg / Singapore	11.00 a.m. CET or CEST on any Dealing Day.	-
Allianz Floating Rate Notes Plus	EUR	Luxembourg / France	11.00 a.m. CET or CEST on any Dealing Day.	-
Allianz Food Security	USD	Luxembourg / Germany / United States	11.00 a.m. CET or CEST on any Dealing Day.	YES
Allianz GEM Equity High Dividend	EUR	Luxembourg / United States	11.00 a.m. CET or CEST on any Dealing Day.	YES
Allianz German Equity	EUR	Luxembourg / Germany	11.00 a.m. CET or CEST on any Dealing Day.	-
Allianz German Small and Micro Cap	EUR	Luxembourg / Germany	11.00 a.m. CET or CEST on any Dealing Day five Dealing Days in advance of a Dealing Day. Subscription and redemption applications received by 11.00 a.m. CET or CEST on any Dealing Day are settled at the Subscription or Redemption Price of the fifth Dealing Day following the Dealing Day. Subscription and redemption applications received after that time are settled at the Subscription or Redemption Price of the Dealing Day after the fifth Dealing Day following the Dealing Day.	-
Allianz Global Aggregate Bond	USD	Luxembourg / United Kingdom / United States	11.00 a.m. CET or CEST on any Dealing Day.	-
Allianz Global Artificial Intelligence	USD	Luxembourg / United States	11.00 a.m. CET or CEST on any Dealing Day.	YES
Allianz Global Capital Plus	EUR	Luxembourg / Germany	11.00 a.m. CET or CEST on any Dealing Day.	YES
Allianz Global Credit SRI	USD	Luxembourg / United Kingdom / United States	11.00 a.m. CET or CEST on any Dealing Day.	-
Allianz Global Diversified Dividend	EUR	Luxembourg / Germany / United States	11.00 a.m. CET or CEST on any Dealing Day.	YES
Allianz Global Dividend	EUR	Luxembourg / Germany / United States	11.00 a.m. CET or CEST on any Dealing Day.	YES
Allianz Global Dynamic Multi Asset Income	USD	Luxembourg / Germany / Hong Kong / United States	11.00 a.m. CET or CEST on any Dealing Day.	YES
Allianz Global Emerging Markets Equity Dividend	USD	Luxembourg / United States	11.00 a.m. CET or CEST on any Dealing Day.	YES
Allianz Global Equity Growth	USD	Luxembourg / Germany	11.00 a.m. CET or CEST on any Dealing Day.	YES
Allianz Global Equity Insights	USD	Luxembourg / Germany / United States	11.00 a.m. CET or CEST on any Dealing Day.	YES
Allianz Global Equity powered by Artificial Intelligence	USD	Luxembourg / Germany / United States	11.00 a.m. CET or CEST on any Dealing Day preceding a Dealing Day. Subscription and redemption applications received by 11.00 a.m. CET or CEST on any Dealing Day preceding a Dealing Day are settled at the Subscription or Redemption Price of the next Dealing Day. Subscription and redemption applications received after that time are settled at the Subscription or Redemption Price of the second Dealing Day following the Dealing Day.	-
Allianz Global Equity Unconstrained	EUR	Luxembourg / United States	11.00 a.m. CET or CEST on any Dealing Day.	YES
Allianz Global Floating Rate Notes Plus	USD	Luxembourg / United Kingdom / United States	11.00 a.m. CET or CEST on any Dealing Day.	-
Allianz Global Government Bond	USD	Luxembourg / United Kingdom / United States	11.00 a.m. CET or CEST on any Dealing Day.	-
Allianz Global High Yield	USD	Luxembourg / United Kingdom / United States	11.00 a.m. CET or CEST on any Dealing Day.	-
Allianz Global Hi-Tech Growth	USD	Luxembourg / Germany	11.00 a.m. CET or CEST on any Dealing Day.	YES
Allianz Global Income	USD	Luxembourg / United States	11.00 a.m. CET or CEST on any Dealing Day.	-
Allianz Global Inflation-Linked Bond	USD	Luxembourg / France / United States	11.00 a.m. CET or CEST on any Dealing Day.	-

Sub-Fund Name	Base Currency	Dealing Day / Valuation Day	Trading Deadline	Fair Value Pricing Model
Allianz Global Intelligent Cities Income	USD	Luxembourg / United States	11.00 a.m. CET or CEST on any Dealing Day.	-
Allianz Global Metals and Mining	EUR	Luxembourg / Germany	11.00 a.m. CET or CEST on any Dealing Day.	YES
Allianz Global Multi-Asset Credit	USD	Luxembourg / United Kingdom / United States	11.00 a.m. CET or CEST on any Dealing Day.	-
Allianz Global Multi-Asset Credit SRI	USD	Luxembourg / United Kingdom / United States	11.00 a.m. CET or CEST on any Dealing Day.	-
Allianz Global Multi Asset Sustainability Balanced	USD	Luxembourg / Germany / Hong Kong / United States	11.00 a.m. CET or CEST on any Dealing Day.	YES
Allianz Global Multi Asset Sustainability Conservative	USD	Luxembourg / Germany / Hong Kong / United States	11.00 a.m. CET or CEST on any Dealing Day.	YES
Allianz Global Multi Asset Sustainability Growth	USD	Luxembourg / Germany / Hong Kong / United States	11.00 a.m. CET or CEST on any Dealing Day.	YES
Allianz Global Opportunistic Bond	USD	Luxembourg / United Kingdom / United States	11.00 a.m. CET or CEST on any Dealing Day.	-
Allianz Global Small Cap Equity	USD	Luxembourg / United States	11.00 a.m. CET or CEST on any Dealing Day.	YES
Allianz Global Sustainability	EUR	Luxembourg	11.00 a.m. CET or CEST on any Dealing Day.	YES
Allianz Global Water	USD	Luxembourg / Germany / United Kingdom / United States	11.00 a.m. CET or CEST on any Dealing Day.	YES
Allianz Green Bond	EUR	Luxembourg / France / Germany / United Kingdom	11.00 a.m. CET or CEST on any Dealing Day.	-
Allianz Green Future	EUR	Luxembourg / Germany	2.00 p.m. CET or CEST on any Dealing Day two Dealing Days in advance of a Dealing Day. Subscription and redemption applications received by 2.00 p.m. CET or CEST on any Dealing Day are settled at the Subscription or Redemption Price of the second Dealing Day following the Dealing Day. Subscription and redemption applications received after that time are settled at the Subscription or Redemption Price of the Dealing Day after the second Dealing Day following the Dealing Day.	-
Allianz Green Transition Bond	USD	Luxembourg / France / United Kingdom	7.00 a.m. CET or CEST on any Dealing Day.	-
Allianz High Dividend Asia Pacific Equity	USD	Luxembourg / Hong Kong	11.00 a.m. CET or CEST on any Dealing Day.	YES
Allianz HKD Income	HKD	Luxembourg / Hong Kong / PRC / United States	11.00 a.m. CET or CEST on any Dealing Day.	-
Allianz Hong Kong Equity	HKD	Luxembourg / Hong Kong	11.00 a.m. CET or CEST on any Dealing Day.	YES
Allianz Income and Growth	USD	Luxembourg / United States	11.00 a.m. CET or CEST on any Dealing Day.	-
Allianz India Equity	USD	Luxembourg / India	11.00 a.m. CET or CEST on any Dealing Day.	YES
Allianz Indonesia Equity	USD	Luxembourg / Indonesia	- 5.00 p.m. Hong Kong Time for applications for subscription or redemptions received by the Singapore registrar and/or transfer agent as appointed by Singapore Representative and Hong Kong Representative on any Dealing Day. - 10.00 a.m. CET or CEST for applications for subscription or redemptions received by other account keeping entities, the Distributors, the Paying Agents or at the Registrar and Transfer Agent on any Dealing Day.	-
Allianz Japan Equity	USD	Luxembourg / Germany / Japan	11.00 a.m. CET or CEST on any Dealing Day.	YES
Allianz Japan Smaller Companies Equity	EUR	Luxembourg / Japan	11.00 a.m. CET or CEST on any Dealing Day.	YES

Sub-Fund Name	Base Currency	Dealing Day / Valuation Day	Trading Deadline	Fair Value Pricing Model
Allianz Laufzeitfonds	EUR	Luxembourg / France / United Kingdom	11.00 a.m. CET or CEST on any Dealing Day - Subscription applications received by 11.00 a.m. CET or CEST on any Dealing Day are settled at the Subscription Price of this Dealing Day. Subscription applications received after that time are settled at the Subscription Price of the first Dealing Day following the Dealing Day. - Redemption applications received by 11.00 a.m. CET or CEST on any Dealing Day are settled at the Redemption Price of the second Dealing Day following the Dealing Day. Redemption applications received after that time are settled at the Redemption Price of the third Dealing Day following the Dealing Day.	-
Allianz Little Dragons	USD	Luxembourg	11.00 a.m. CET or CEST on any Dealing Day.	YES
Allianz Metaverse	USD	Luxembourg / United States	11.00 a.m. CET or CEST on any Dealing Day.	YES
Allianz Multi Asset Long / Short	USD	Luxembourg / Germany / United States	11.00 a.m. CET or CEST on any Dealing Day.	-
Allianz Multi Asset Opportunities	USD	Luxembourg / Germany / United States	11.00 a.m. CET or CEST on any Dealing Day.	-
Allianz Multi Asset Risk Premia	USD	Luxembourg / Germany / United States	11.00 a.m. CET or CEST on any Dealing Day.	-
Allianz Oriental Income	USD	Luxembourg	11.00 a.m. CET or CEST on any Dealing Day.	YES
Allianz Pet and Animal Wellbeing	USD	Luxembourg / Germany / United States	11.00 a.m. CET or CEST on any Dealing Day.	YES
Allianz Positive Change	USD	Luxembourg / Germany / United States	11.00 a.m. CET or CEST on any Dealing Day.	YES
Allianz Premium Champions	EUR	Luxembourg / Germany / United States	11.00 a.m. CET or CEST on any Dealing Day.	YES
Allianz Renminbi Fixed Income	RMB	Luxembourg / PRC / Singapore	11.00 a.m. CET or CEST on any Dealing Day.	-
Allianz SDG Euro Credit	EUR	Luxembourg / France	11.00 a.m. CET or CEST on any Dealing Day.	-
Allianz SDG Global Equity	EUR	Luxembourg / Germany / United States	11.00 a.m. CET or CEST on any Dealing Day	-
Allianz Select Income and Growth	USD	Luxembourg / United States	11.00 a.m. CET or CEST on any Dealing Day.	-
Allianz Selection Alternative	EUR	Luxembourg / France	11.00 a.m. CET or CEST on any Dealing Day.	-
Allianz Selection Fixed Income	EUR	Luxembourg / France	11.00 a.m. CET or CEST on any Dealing Day.	-
Allianz Selection Small and Mid Cap Equity	EUR	Luxembourg / France	11.00 a.m. CET or CEST on any Dealing Day.	-
Allianz Selective Global High Income	USD	Luxembourg / United Kingdom / United States	11.00 a.m. CET or CEST on any Dealing Day.	-
Allianz SGD Income	SGD	Luxembourg / Singapore	11.00 a.m. CET or CEST on any Dealing Day.	-
Allianz Short Duration Global Bond SRI	USD	Luxembourg / Hong Kong / United Kingdom / United States	11.00 a.m. CET or CEST on any Dealing Day.	-
Allianz Smart Energy	USD	Luxembourg / Germany / United States	11.00 a.m. CET or CEST on any Dealing Day.	YES
Allianz Social Conviction Equity	EUR	Luxembourg / France	11.00 a.m. CET or CEST on any Dealing Day.	-
Allianz Strategic Bond	USD	Luxembourg / United Kingdom	11.00 a.m. CET or CEST on any Dealing Day.	-
Allianz Strategy Select 30	EUR	Luxembourg / Germany / United States	11.00 a.m. CET or CEST on any Dealing Day.	-
Allianz Strategy Select 50	EUR	Luxembourg / Germany / United States	11.00 a.m. CET or CEST on any Dealing Day.	-
Allianz Strategy Select 75	EUR	Luxembourg / Germany / United States	11.00 a.m. CET or CEST on any Dealing Day.	-
Allianz Strategy4Life 30	EUR	Luxembourg / Germany / United States	11.00 a.m. CET or CEST on any Dealing Day.	-

Sub-Fund Name	Base Currency	Dealing Day / Valuation Day	Trading Deadline	Fair Value Pricing Model
Allianz Strategy4Life 50	EUR	Luxembourg / Germany / United States	11.00 a.m. CET or CEST on any Dealing Day.	-
Allianz Strategy4Life 75	EUR	Luxembourg / Germany / United States	11.00 a.m. CET or CEST on any Dealing Day.	-
Allianz Strategy4Life Europe 40	EUR	Luxembourg / Germany / United States	11.00 a.m. CET or CEST on any Dealing Day	-
Allianz Sustainable Health Evolution	USD	Luxembourg / Germany / United States	11.00 a.m. CET or CEST on any Dealing Day.	YES
Allianz Sustainable Multi Asset 75	EUR	Luxembourg / Germany / United States	6.00 p.m. CET or CEST on any Dealing Day preceding a Dealing Day. Subscription and redemption applications received by 6.00 p.m. CET or CEST on any Dealing Day preceding a Dealing Day are settled at the Subscription or Redemption Price of the next Dealing Day. Subscription and redemption applications received after that time are settled at the Subscription or Redemption Price of the second Dealing Day following the Dealing Day.	-
Allianz Systematic Enhanced US Equity SRI	USD	Luxembourg / Germany / United States	11.00 a.m. CET or CEST on any Dealing Day.	-
Allianz Target Maturity Euro Bond I	EUR	Luxembourg / Germany / United Kingdom (valid until 19 October 2023) Luxembourg / France / United Kingdom (valid as of 20 October 2023)	11.00 a.m. CET or CEST on any Dealing Day. - Subscription applications received by 11.00 a.m. CET or CEST on any Dealing Day are settled at the Subscription Price of this Dealing Day. Subscription applications received after that time are settled at the Subscription Price of the first Dealing Day following the Dealing Day. - Redemption applications received by 11.00 a.m. CET or CEST on any Dealing Day are settled at the Redemption Price of the second Dealing Day following the Dealing Day. Redemption applications received after that time are settled at the Redemption Price of the third Dealing Day following the Dealing Day.	-
Allianz Target Maturity Euro Bond II	EUR	Luxembourg / Germany (valid until 19 October 2023) Luxembourg / France / United Kingdom (valid as of 20 October 2023)	11.00 a.m. CET or CEST on any Dealing Day. - Subscription applications received by 11.00 a.m. CET or CEST on any Dealing Day are settled at the Subscription Price of this Dealing Day. Subscription applications received after that time are settled at the Subscription Price of the first Dealing Day following the Dealing Day. - Redemption applications received by 11.00 a.m. CET or CEST on any Dealing Day are settled at the Redemption Price of the second Dealing Day following the Dealing Day. Redemption applications received after that time are settled at the Redemption Price of the third Dealing Day following the Dealing Day.	-
Allianz Thematica	USD	Luxembourg / Germany / United States	11.00 a.m. CET or CEST on any Dealing Day.	YES
Allianz Total Return Asian Equity	USD	Luxembourg	11.00 a.m. CET or CEST on any Dealing Day.	YES
Allianz Treasury Short Term Plus Euro	EUR	Luxembourg	11.00 a.m. CET or CEST on any Dealing Day.	-
Allianz Trend and Brands	EUR	Luxembourg / Germany	2.00 p.m. CET or CEST on any Dealing Day two Dealing Days in advance of a Dealing Day. Subscription and redemption applications received by 2.00 p.m. CET or CEST on any Dealing Day are settled at the Subscription or Redemption Price of the second Dealing Day following the Dealing Day. Subscription and redemption applications received after that time are settled at the Subscription or Redemption Price of the Dealing Day after the second Dealing Day following the Dealing Day.	-
Allianz UK Government Bond	GBP	Luxembourg / United Kingdom	11.00 a.m. CET or CEST on any Dealing Day.	-
Allianz Unconstrained Multi Asset Strategy	EUR	Luxembourg / United States	11.00 a.m. CET or CEST on any Dealing Day.	-

Sub-Fund Name	Base Currency	Dealing Day / Valuation Day	Trading Deadline	Fair Value Pricing Model
Allianz US Equity Fund	USD	Luxembourg / United States	11.00 a.m. CET or CEST on any Dealing Day.	YES
Allianz US Equity Plus	USD	Luxembourg / United States	11.00 a.m. CET or CEST on any Dealing Day.	-
Allianz US Equity powered by Artificial Intelligence	USD	Luxembourg / Germany / United States	11.00 a.m. CET or CEST on any Dealing Day preceding a Dealing Day. Subscription and redemption applications received by 11.00 a.m. CET or CEST on any Dealing Day preceding a Dealing Day are settled at the Subscription or Redemption Price of the next Dealing Day. Subscription and redemption applications received after that time are settled at the Subscription or Redemption Price of the second Dealing Day following the Dealing Day.	-
Allianz US High Yield	USD	Luxembourg / United States	11.00 a.m. CET or CEST on any Dealing Day.	-
Allianz US Investment Grade Credit	USD	Luxembourg / United States	11.00 a.m. CET or CEST on any Dealing Day.	-
Allianz US Large Cap Value	USD	Luxembourg / United States	11.00 a.m. CET or CEST on any Dealing Day.	YES
Allianz US Short Duration High Income Bond	USD	Luxembourg / United States	11.00 a.m. CET or CEST on any Dealing Day.	-
Allianz Volatility Strategy Fund	EUR	Luxembourg / Germany	11.00 a.m. CET or CEST on any Dealing Day preceding a Dealing Day. Subscription and redemption applications received by 11.00 a.m. CET or CEST on any Dealing Day preceding a Dealing Day are settled at the Subscription or Redemption Price of the next Dealing Day. Subscription and redemption applications received after that time are settled at the Subscription or Redemption Price of the second Dealing Day following the Dealing Day.	-
IndexManagement Balance	EUR	Luxembourg / Germany	2.00 p.m. CET or CEST on any Dealing Day two Dealing Days in advance of a Dealing Day. Subscription and redemption applications received by 2.00 p.m. CET or CEST on any Dealing Day are settled at the Subscription or Redemption Price of the second Dealing Day following the Dealing Day. Subscription and redemption applications received after that time are settled at the Subscription or Redemption Price of the Dealing Day after the second Dealing Day following the Dealing Day.	-
IndexManagement Chance	EUR	Luxembourg / Germany	2.00 p.m. CET or CEST on any Dealing Day two Dealing Days in advance of a Dealing Day. Subscription and redemption applications received by 2.00 p.m. CET or CEST on any Dealing Day are settled at the Subscription or Redemption Price of the second Dealing Day following the Dealing Day. Subscription and redemption applications received after that time are settled at the Subscription or Redemption Price of the Dealing Day after the second Dealing Day following the Dealing Day.	-
IndexManagement Substanz	EUR	Luxembourg / Germany	2.00 p.m. CET or CEST on any Dealing Day two Dealing Days in advance of a Dealing Day. Subscription and redemption applications received by 2.00 p.m. CET or CEST on any Dealing Day are settled at the Subscription or Redemption Price of the second Dealing Day following the Dealing Day. Subscription and redemption applications received after that time are settled at the Subscription or Redemption Price of the Dealing Day after the second Dealing Day following the Dealing Day.	-

Sub-Fund Name	Base Currency	Dealing Day / Valuation Day	Trading Deadline	Fair Value Pricing Model
IndexManagement Wachstum	EUR	Luxembourg / Germany	2.00 p.m. CET or CEST on any Dealing Day two Dealing Days in advance of a Dealing Day. Subscription and redemption applications received by 2.00 p.m. CET or CEST on any Dealing Day are settled at the Subscription or Redemption Price of the second Dealing Day following the Dealing Day. Subscription and redemption applications received after that time are settled at the Subscription or Redemption Price of the Dealing Day after the second Dealing Day following the Dealing Day.	-

Appendix 4

Risk Management Process

Sub-Fund Name	Approach	Expected Level of Leverage in terms of gross derivative exposure of a Sub-Fund's Net Asset Value	Reference Portfolio
Allianz ActiveInvest Balanced	Commitment Approach	–	–
Allianz ActiveInvest Defensive	Commitment Approach	–	–
Allianz ActiveInvest Dynamic	Commitment Approach	–	–
Allianz Advanced Fixed Income Euro	Relative Value-at-Risk	0-2	The reference portfolio corresponds to the composition of the BLOOMBERG Euro Aggregate 1-10 Year.
Allianz Advanced Fixed Income Global	Relative Value-at-Risk	0-2	The reference portfolio corresponds to the composition of the J.P. MORGAN Government Bond (GBI) Global 1-10 Year.
Allianz Advanced Fixed Income Global Aggregate	Relative Value-at-Risk	0-2	The reference portfolio corresponds to the composition of the BLOOMBERG Global Aggregate 500 Excl. CNY.
Allianz Advanced Fixed Income Short Duration	Relative Value-at-Risk	0-2	The reference portfolio corresponds to the composition of 75% BLOOMBERG Euro Aggregate 1-3 Year + 25% ICE BOFAML Euro High Yield BB-B.
Allianz All China Equity	Relative Value-at-Risk	0-2	The reference portfolio corresponds to the composition of the MSCI China All Shares.
Allianz Alternative Investment Strategies	Absolute Value-at-Risk	0-2	–
Allianz American Income	Absolute Value-at-Risk	0-2	–
Allianz Asian Multi Income Plus	Commitment Approach	–	–
Allianz Asian Small Cap Equity	Relative Value-at-Risk	0-0.5	The reference portfolio corresponds to the composition of the MSCI AC Asia Excl. Japan Small Cap.
Allianz Best Ideas 2025	Relative Value-at-Risk	0-5	The reference portfolio corresponds to the composition of 70% MSCI AC World (ACWI) + 30% BLOOMBERG Global Aggregate.
Allianz Best of Managers	Commitment Approach	–	–
Allianz Best Styles Euroland Equity	Relative Value-at-Risk	0-2	The reference portfolio corresponds to the composition of the MSCI EMU.
Allianz Best Styles Europe Equity	Relative Value-at-Risk	0-2	The reference portfolio corresponds to the composition of the MSCI Europe.
Allianz Best Styles Europe Equity SRI	Relative Value-at-Risk	0-2	The reference portfolio corresponds to the composition of the MSCI Europe Ext. SRI 5% Issuer Capped.
Allianz Best Styles Global AC Equity	Relative Value-at-Risk	0-2	The reference portfolio corresponds to the composition of the MSCI AC World (ACWI).
Allianz Best Styles Global Equity	Relative Value-at-Risk	0-2	The reference portfolio corresponds to the composition of the MSCI World.
Allianz Best Styles Global Equity SRI	Relative Value-at-Risk	0-2	The reference portfolio corresponds to the composition of the MSCI World Ext. SRI 5% Issuer Capped.
Allianz Best Styles Pacific Equity	Relative Value-at-Risk	0-2	The reference portfolio corresponds to the composition of the MSCI Pacific.
Allianz Best Styles US Equity	Relative Value-at-Risk	0-2	The reference portfolio corresponds to the composition of the S&P 500.
Allianz Better World Defensive	Commitment Approach	–	–
Allianz Better World Dynamic	Commitment Approach	–	–

Sub-Fund Name	Approach	Expected Level of Leverage in terms of gross derivative exposure of a Sub-Fund's Net Asset Value	Reference Portfolio
Allianz Better World Moderate	Commitment Approach	–	–
Allianz Blockchain Opportunities	Commitment Approach	–	–
Allianz Capital Plus	Relative Value-at-Risk	0-2	The reference portfolio corresponds to the composition of 70% BLOOMBERG Euro Aggregate 1-10 Year + 30% MSCI Europe.
Allianz Capital Plus Global	Relative Value-at-Risk	0-2	The reference portfolio corresponds to the composition of 70% BLOOMBERG Global Aggregate 500 Excl. CNY + 30% MSCI AC World (ACWI).
Allianz China A Opportunities	Relative Value-at-Risk	0-2	The reference portfolio corresponds to the composition of the MSCI China A.
Allianz China A-Shares	Relative Value-at-Risk	0-2	The reference portfolio corresponds to the composition of the MSCI China A Onshore.
Allianz China Equity	Relative Value-at-Risk	0-2	The reference portfolio corresponds to the composition of the MSCI China 10/40.
Allianz China Future Technologies	Commitment Approach	–	–
Allianz China Healthy Living	Commitment Approach	–	–
Allianz China Multi Income Plus	Commitment Approach	–	–
Allianz China Strategic Bond	Relative Value-at-Risk	0-2	The reference portfolio corresponds to the composition of the J.P. MORGAN Asia Credit China.
Allianz China Thematica	Relative Value-at-Risk	0-2	The reference portfolio corresponds to the composition of the MSCI China All Shares.
Allianz Clean Planet	Commitment Approach	–	–
Allianz Climate Transition	Relative Value-at-Risk	0-0.5	The reference portfolio corresponds to the composition of the MSCI Europe.
Allianz Convertible Bond	Relative Value-at-Risk	0-2	The reference portfolio corresponds to the composition of the Refinitiv Europe Focus CB.
Allianz Coupon Select Plus V	Commitment Approach	–	–
Allianz Coupon Select Plus VI	Commitment Approach	–	–
Allianz Credit Opportunities	Commitment Approach	–	–
Allianz Credit Opportunities Plus	Absolute Value-at-Risk	0-5	–
Allianz Cyber Security	Commitment Approach	–	–
Allianz Dynamic Allocation Plus Equity	Relative Value-at-Risk	0-5	The reference portfolio corresponds to the composition of the MSCI World.
Allianz Dynamic Asian High Yield Bond	Relative Value-at-Risk	0-2	The reference portfolio corresponds to the composition of the J.P. MORGAN JACI Non-Investment Grade Custom.
Allianz Dynamic Commodities	Relative Value-at-Risk	0-5	The reference portfolio corresponds to the composition of the BLOOMBERG Commodity Excl. Agriculture Excl. Livestock Capped Total Return (Shifted By 2 Days Forward) (hedged into EUR) (valid until 30 September 2023) / BLOOMBERG Commodity Excl. Agriculture Excl. Livestock Capped (valid as of 1 October 2023).
Allianz Dynamic Multi Asset Strategy SRI 15	Commitment Approach	–	–
Allianz Dynamic Multi Asset Strategy SRI 50	Commitment Approach	–	–
Allianz Dynamic Multi Asset Strategy SRI 75	Commitment Approach	–	–
Allianz Emerging Asia Equity	Relative Value-at-Risk	0-0.5	The reference portfolio corresponds to the composition of the MSCI Emerging Frontier Markets Asia.

Sub-Fund Name	Approach	Expected Level of Leverage in terms of gross derivative exposure of a Sub-Fund's Net Asset Value	Reference Portfolio
Allianz Emerging Europe Equity	Relative Value-at-Risk	0-0.5	The reference portfolio corresponds to the composition of the MSCI EFM Europe + CIS.
Allianz Emerging Markets Equity	Relative Value-at-Risk	0-2	The reference portfolio corresponds to the composition of the MSCI Emerging Markets.
Allianz Emerging Markets Equity Opportunities	Relative Value-at-Risk	0-0.5	The reference portfolio corresponds to the composition of the MSCI Emerging Markets.
Allianz Emerging Markets Equity SRI	Relative Value-at-Risk	0-2	The reference portfolio corresponds to the composition of the MSCI Emerging Markets Ext. SRI 5% Issuer Capped.
Allianz Emerging Markets Multi Asset Income	Absolute Value-at-Risk	0-2	-
Allianz Emerging Markets Select Bond	Relative Value-at-Risk	0-5	The reference portfolio corresponds to the composition of the J.P. MORGAN Emerging Markets Equal Weight.
Allianz Emerging Markets Short Duration Bond	Relative Value-at-Risk	0-5	The reference portfolio corresponds to the composition of the J.P. MORGAN Corporate Emerging Markets Bond Broad Diversified.
Allianz Emerging Markets Sovereign Bond	Relative Value-at-Risk	0-2	The reference portfolio corresponds to the composition of the J.P. MORGAN Emerging Market Bond (EMBI) Global Diversified.
Allianz Emerging Markets SRI Bond	Relative Value-at-Risk	0-2	The reference portfolio corresponds to the composition of the J.P. MORGAN ESG Emerging Market Bond (EMBI) Global Diversified.
Allianz Emerging Markets SRI Corporate Bond	Relative Value-at-Risk	0-2	The reference portfolio corresponds to the composition of the J.P. MORGAN ESG Corporate Emerging Markets Bond (CEMBI) Broad Diversified.
Allianz Enhanced All China Equity	Relative Value-at-Risk	0-2	The reference portfolio corresponds to the composition of the MSCI China All Shares.
Allianz Enhanced Short Term Euro	Absolute Value-at-Risk	0-2	-
Allianz Euro Balanced	Relative Value-at-Risk	0-2	The reference portfolio is the 50% IBOXX EUR Eurozone + 50% MSCI EMU.
Allianz Euro Bond	Relative Value-at-Risk	0-5	The reference portfolio corresponds to the composition of the BLOOMBERG Euro Aggregate.
Allianz Euro Bond Short Term 1-3 Plus	Relative Value-at-Risk	0-2	The reference portfolio corresponds to the composition of 50% J.P. MORGAN EMU 1-3 Year + 50% BLOOMBERG Euro Corporate.
Allianz Euro Credit SRI	Relative Value-at-Risk	0-2	The reference portfolio corresponds to the composition of the ICE BOFAML Euro Corporate Index.
Allianz Euro Government Bond	Relative Value-at-Risk	0-2	The reference portfolio corresponds to the composition of the IBOXX EUR Eurozone.
Allianz Euro High Yield Bond	Relative Value-at-Risk	0-2	The reference portfolio corresponds to the composition of the ICE BOFAML Euro High Yield BB-B.
Allianz Euro High Yield Defensive	Relative Value-at-Risk	0-2	The reference portfolio corresponds to the composition of the ICE BOFAML Euro Non-Financial High Yield BB-B.
Allianz Euro Inflation-linked Bond	Relative Value-at-Risk	0-2	The reference portfolio corresponds to the composition of the BLOOMBERG Euro Government Inflation Linked Bond.
Allianz Euroland Equity Growth	Relative Value-at-Risk	0-0.5	The reference portfolio corresponds to the composition of the S&P Eurozone Large Mid Cap Growth.
Allianz Europe Equity Growth	Relative Value-at-Risk	0-0.5	The reference portfolio corresponds to the composition of the S&P Europe Large Mid Cap Growth.
Allianz Europe Equity Growth Select	Relative Value-at-Risk	0-0.5	The reference portfolio corresponds to the composition of the S&P Europe Large Cap Growth.

Sub-Fund Name	Approach	Expected Level of Leverage in terms of gross derivative exposure of a Sub-Fund's Net Asset Value	Reference Portfolio
Allianz Europe Equity powered by Artificial Intelligence	Relative Value-at-Risk	0-2	The reference portfolio corresponds to the composition of the MSCI Europe.
Allianz Europe Equity SRI	Relative Value-at-Risk	0-2	The reference portfolio corresponds to the composition of the MSCI Europe.
Allianz Europe Equity Value	Relative Value-at-Risk	0-2	The reference portfolio corresponds to the composition of the S&P Europe Large Mid Cap Value.
Allianz Europe Income and Growth	Absolute Value-at-Risk	0-2	-
Allianz Europe Mid Cap Equity	Relative Value-at-Risk	0-0.5	The reference portfolio corresponds to the composition of the MSCI Europe Mid Cap.
Allianz Europe Small and Micro Cap Equity	Relative Value-at-Risk	0-2	The reference portfolio corresponds to the composition of 70% MSCI Europe Small Cap + 30% MSCI Europe Micro Cap.
Allianz Europe Small Cap Equity	Relative Value-at-Risk	0-0.5	The reference portfolio corresponds to the composition of the MSCI Europe Small Cap.
Allianz European Bond RC	Absolute Value-at-Risk	0-5	-
Allianz European Equity Dividend	Relative Value-at-Risk	0-0.5	The reference portfolio corresponds to the composition of the MSCI Europe.
Allianz Fixed Income Macro	Absolute Value-at-Risk	0-35 The effective level of leverage may be higher than the expected level of leverage from time to time, primarily due to the acquisition of money market futures and related instruments, especially when exposures are capped and/or floored. This may particularly apply in the following cases: butterfly strategies, put/call-spreads or covered calls. As an additional example, a long only strategy aiming at a target duration of about 8 years would probably use leverage to a large extent.	-
Allianz Flexi Asia Bond	Commitment Approach	-	-
Allianz Floating Rate Notes Plus	Relative Value-at-Risk	0-2	The reference portfolio corresponds to the composition of 60% J.P. MORGAN EMU 1-3 Year + 40% BLOOMBERG EUR Floating Rate Note.
Allianz Food Security	Commitment Approach	-	-
Allianz GEM Equity High Dividend	Relative Value-at-Risk	0-0.5	The reference portfolio corresponds to the composition of the MSCI Emerging Markets.
Allianz German Equity	Relative Value-at-Risk	0-0.5	The reference portfolio corresponds to the composition of the DAX.
Allianz German Small and Micro Cap	Relative Value-at-Risk	0-2	The reference portfolio corresponds to the composition of the SDAX.
Allianz Global Aggregate Bond	Relative Value-at-Risk	0-2	The reference portfolio corresponds to the composition of the BLOOMBERG Global Aggregate.
Allianz Global Artificial Intelligence	Commitment Approach	-	-
Allianz Global Capital Plus	Relative Value-at-Risk	0-2	The reference portfolio corresponds to the composition of 70% BLOOMBERG Global Aggregate 500 Excl. CNY + 30% MSCI AC World (ACWI).

Sub-Fund Name	Approach	Expected Level of Leverage in terms of gross derivative exposure of a Sub-Fund's Net Asset Value	Reference Portfolio
Allianz Global Credit SRI	Relative Value-at-Risk	0-2	The reference portfolio corresponds to the composition of the BLOOMBERG Global Aggregate Credit.
Allianz Global Diversified Dividend	Relative Value-at-Risk	0-2	The reference portfolio corresponds to the composition of the MSCI World High Dividend Yield.
Allianz Global Dividend	Relative Value-at-Risk	0-2	The reference portfolio corresponds to the composition of the MSCI AC World (ACWI).
Allianz Global Dynamic Multi Asset Income	Absolute Value-at-Risk	0-2	-
Allianz Global Emerging Markets Equity Dividend	Relative Value-at-Risk	0-2	The reference portfolio corresponds to the composition of the MSCI Emerging Markets.
Allianz Global Equity Growth	Relative Value-at-Risk	0-0.5	The reference portfolio corresponds to the composition of the MSCI AC World (ACWI).
Allianz Global Equity Insights	Relative Value-at-Risk	0-2	The reference portfolio corresponds to the composition of the MSCI AC World (ACWI).
Allianz Global Equity powered by Artificial Intelligence	Relative Value-at-Risk	0-2	The reference portfolio corresponds to the composition of the MSCI World.
Allianz Global Equity Unconstrained	Relative Value-at-Risk	0-0.5	The reference portfolio corresponds to the composition of the MSCI AC World (ACWI).
Allianz Global Floating Rate Notes Plus	Relative Value-at-Risk	0-2	The reference portfolio corresponds to the composition of 50% ICE BOFAML Global Floating Rate High Yield + 25% BLOOMBERG EUR Floating Rate Notes + 25% BLOOMBERG US Floating Rate Notes.
Allianz Global Government Bond	Relative Value-at-Risk	0-2	The reference portfolio corresponds to the composition of the FTSE World Government Bond (WGBI).
Allianz Global High Yield	Relative Value-at-Risk	0-2	The reference portfolio corresponds to the composition of the ICE BOFAML Global High Yield Constrained.
Allianz Global Hi-Tech Growth	Relative Value-at-Risk	0-0.5	The reference portfolio corresponds to the composition of the MSCI World Information Technology.
Allianz Global Income	Absolute Value-at-Risk	0-2	-
Allianz Global Inflation-Linked Bond	Relative Value-at-Risk	0-5	The reference portfolio corresponds to the composition of the BLOOMBERG World Government Inflation Linked Bond.
Allianz Global Intelligent Cities Income	Commitment Approach	-	-
Allianz Global Metals and Mining	Relative Value-at-Risk	0-0.5	The reference portfolio corresponds to the composition of the MSCI ACWI Metals & Mining 30% Buffer 10/40.
Allianz Global Multi-Asset Credit	Absolute Value-at-Risk	0-2	-
Allianz Global Multi-Asset Credit SRI	Absolute Value-at-Risk	0-2	-
Allianz Global Multi Asset Sustainability Balanced	Absolute Value-at-Risk	0-2	-
Allianz Global Multi Asset Sustainability Conservative	Absolute Value-at-Risk	0-2	-
Allianz Global Multi Asset Sustainability Growth	Absolute Value-at-Risk	0-2	-
Allianz Global Opportunistic Bond	Relative Value-at-Risk	0-5	The reference portfolio corresponds to the composition of the BLOOMBERG Global Aggregate Bond.

Sub-Fund Name	Approach	Expected Level of Leverage in terms of gross derivative exposure of a Sub-Fund's Net Asset Value	Reference Portfolio
Allianz Global Small Cap Equity	Relative Value-at-Risk	0-0.5	The reference portfolio corresponds to the composition of the MSCI World Small Cap.
Allianz Global Sustainability	Relative Value-at-Risk	0-0.5	The reference portfolio corresponds to the composition of the DOW JONES Sustainability World.
Allianz Global Water	Commitment Approach	-	-
Allianz Green Bond	Relative Value-at-Risk	0-2	The reference portfolio corresponds to the composition of the ICE BOFAMLGreen Bond.
Allianz Green Future	Commitment Approach	-	-
Allianz Green Transition Bond	Relative Value-at-Risk	0-2	The reference portfolio corresponds to the composition of 1/3 BLOOMBERG MSCI Global Green Bond + 1/3 BLOOMBERG MSCI Global Corporate Sustainability + 1/3 J.P. MORGAN ESG Emerging Market Bond (EMBI) Global Diversified.
Allianz High Dividend Asia Pacific Equity	Relative Value-at-Risk	0-2	The reference portfolio corresponds to the composition of the MSCI AC Asia Pacific Excl. Japan.
Allianz HKD Income	Commitment Approach	-	-
Allianz Hong Kong Equity	Relative Value-at-Risk	0-2	The reference portfolio corresponds to the composition of the FTSE MPF Hong Kong.
Allianz Income and Growth	Absolute Value-at-Risk	0-2	-
Allianz India Equity	Commitment Approach	-	-
Allianz Indonesia Equity	Commitment Approach	-	-
Allianz Japan Equity	Relative Value-at-Risk	0-0.5	The reference portfolio corresponds to the composition of the TOPIX.
Allianz Japan Smaller Companies Equity	Relative Value-at-Risk	0-0.5	The reference portfolio corresponds to the composition of the MSCI Japan Small Cap.
Allianz Laufzeitfonds	Commitment Approach	-	-
Allianz Little Dragons	Commitment Approach	-	-
Allianz Metaverse	Commitment Approach	-	-
Allianz Multi Asset Long / Short	Absolute Value-at-Risk	0-5	-
Allianz Multi Asset Opportunities	Absolute Value-at-Risk	0-5	-
Allianz Multi Asset Risk Premia	Absolute Value-at-Risk	5-18 The effective level of leverage may be higher than the expected level of leverage from time to time due to investment in money market derivatives or related instruments, calendar spreads, portfolio risk hedges with option strategies or fixed income relative value exposures like butterfly strategies.	-
Allianz Oriental Income	Commitment Approach	-	-
Allianz Pet and Animal Wellbeing	Commitment Approach	-	-
Allianz Positive Change	Commitment Approach	-	-
Allianz Premium Champions	Commitment Approach	-	-
Allianz Renminbi Fixed Income	Commitment Approach	-	-

Sub-Fund Name	Approach	Expected Level of Leverage in terms of gross derivative exposure of a Sub-Fund's Net Asset Value	Reference Portfolio
Allianz SDG Euro Credit	Relative Value-at-Risk	0-2	The reference portfolio corresponds to the composition of the BLOOMBERG Euro Aggregate Corporate.
Allianz SDG Global Equity	Relative Value-at-Risk	0-2	The reference portfolio corresponds to the composition of the MSCI World.
Allianz Select Income and Growth	Commitment Approach	-	-
Allianz Selection Alternative	Commitment Approach	-	-
Allianz Selection Fixed Income	Commitment Approach	-	-
Allianz Selection Small and Mid Cap Equity	Commitment Approach	-	-
Allianz Selective Global High Income	Absolute Value-at-Risk	0-2	-
Allianz SGD Income	Absolute Value-at-Risk	0-2	-
Allianz Short Duration Global Bond SRI	Commitment Approach	-	-
Allianz Smart Energy	Commitment Approach	-	-
Allianz Social Conviction Equity	Relative Value-at-Risk	0-2	The reference portfolio corresponds to the composition of the MSCI EMU.
Allianz Strategic Bond	Absolute Value-at-Risk	0-10 The effective level of leverage may be higher than the expected level of leverage from time to time, primarily due to the acquisition of money market futures.	-
Allianz Strategy Select 30	Commitment Approach	-	-
Allianz Strategy Select 50	Commitment Approach	-	-
Allianz Strategy Select 75	Commitment Approach	-	-
Allianz Strategy4Life 30	Commitment Approach	-	-
Allianz Strategy4Life 50	Commitment Approach	-	-
Allianz Strategy4Life 75	Commitment Approach	-	-
Allianz Strategy4Life Europe 40	Commitment Approach	-	-
Allianz Sustainable Health Evolution	Commitment Approach	-	-
Allianz Sustainable Multi Asset 75	Commitment Approach	-	-
Allianz Systematic Enhanced US Equity SRI	Relative Value-at-Risk	0-2	The reference portfolio corresponds to the composition of the MSCI USA ESG Screened.
Allianz Target Maturity Euro Bond I	Commitment Approach	-	-
Allianz Target Maturity Euro Bond II	Commitment Approach	-	-
Allianz Thematica	Commitment Approach	-	-
Allianz Total Return Asian Equity	Commitment Approach	-	-
Allianz Treasury Short Term Plus Euro	Absolute Value-at-Risk	0-5	-
Allianz Trend and Brands	Commitment Approach	-	-

Sub-Fund Name	Approach	Expected Level of Leverage in terms of gross derivative exposure of a Sub-Fund's Net Asset Value	Reference Portfolio
Allianz UK Government Bond	Relative Value-at-Risk	0-5	The reference portfolio corresponds to the composition of the FTSE Actuaries UK Conventional Gilts All Stocks.
Allianz Unconstrained Multi Asset Strategy	Absolute Value-at-Risk	0-7	-
Allianz US Equity Fund	Relative Value-at-Risk	0-0.5	The reference portfolio corresponds to the composition of the S&P 500.
Allianz US Equity Plus	Commitment Approach	-	-
Allianz US Equity powered by Artificial Intelligence	Relative Value-at-Risk	0-2	The reference portfolio corresponds to the composition of the S&P 500.
Allianz US High Yield	Absolute Value-at-Risk	0-0.5	-
Allianz US Investment Grade Credit	Relative Value-at-Risk	0-2	The reference portfolio corresponds to the composition of the Bloomberg US Corporate.
Allianz US Large Cap Value	Relative Value-at-Risk	0-2	The reference portfolio corresponds to the composition of the Russell 1000 Value.
Allianz US Short Duration High Income Bond	Absolute Value-at-Risk	0-0.5	-
Allianz Volatility Strategy Fund	Absolute Value-at-Risk	0-2	-
IndexManagement Balance	Relative Value-at-Risk	0-2	The reference portfolio corresponds to the composition of 20% MSCI World + 16% MSCI Europe + 15% BLOOMBERG Euro Aggregate Corporate + 15% BLOOMBERG Euro Aggregate Treasury + 15 % BLOOMBERG US Corporate + 15% BLOOMBERG US Treasury + 4% MSCI Emerging Markets.
IndexManagement Chance	Relative Value-at-Risk	0-2	The reference portfolio corresponds to the composition of 40% MSCI World + 32% MSCI Europe + 8% MSCI Emerging Markets + 5% BLOOMBERG Euro Aggregate Corporate + 5% BLOOMBERG Euro Aggregate Treasury + 5 % BLOOMBERG US Corporate + 5% BLOOMBERG US Treasury.
IndexManagement Substanz	Relative Value-at-Risk	0-2	The reference portfolio corresponds to the composition of 20% BLOOMBERG Euro Aggregate Corporate + 20% BLOOMBERG Euro Aggregate Treasury + 20% BLOOMBERG US Corporate + 20% BLOOMBERG US Treasury + 10% MSCI World + 8% MSCI Europe + 2% MSCI Emerging Markets.
IndexManagement Wachstum	Relative Value-at-Risk	0-2	The reference portfolio corresponds to the composition of 30% MSCI World + 24% MSCI Europe + 10% BLOOMBERG Euro Aggregate Corporate + 10% BLOOMBERG Euro Aggregate Treasury + 10% BLOOMBERG US Corporate + 10% BLOOMBERG US Treasury + 6% MSCI Emerging Markets.

Appendix 5

Investment Manager / Sub-Investment Manager / Investment Advisor

The following notes apply to all Sub-Funds:

- Investment management may be performed by the Management Company or may be delegated to a specific Investment Manager. The full name of the Investment Manager is listed under Definitions. If the Investment Manager has delegated his duties to one or more sub-investment manager(s) indications are made within the column “Investment Manager/Sub-Investment Manager”. The appointment of sub-investment manager(s) shall ensure an appropriate coverage of all Sub-Fund’s assets during all relevant global time zones and/or as far as it concerns the respective regional market by either the investment manager or the sub-investment manager(s).
- Investment Advisors whose fees are paid out of a Sub-Fund’s assets are disclosed in this Appendix 5.

Sub-Fund Name	Investment Manager / Sub-Investment Manager, Investment Advisor
Allianz ActiveInvest Balanced	AllianzGI
Allianz ActiveInvest Defensive	AllianzGI
Allianz ActiveInvest Dynamic	AllianzGI
Allianz Advanced Fixed Income Euro	AllianzGI
Allianz Advanced Fixed Income Global	AllianzGI
Allianz Advanced Fixed Income Global Aggregate	AllianzGI
Allianz Advanced Fixed Income Short Duration	AllianzGI
Allianz All China Equity	AllianzGI AP
Allianz Alternative Investment Strategies	AllianzGI
Allianz American Income	Voya IM
Allianz Asian Multi Income Plus	AllianzGI AP AllianzGI AP acting in its function as the Sub-Fund’s lead investment manager has partially delegated the investment management to AllianzGI Singapore acting as a sub-investment manager.
Allianz Asian Small Cap Equity	AllianzGI AP
Allianz Best Ideas 2025	co-managed by AllianzGI and AllianzGI UK
Allianz Best of Managers	AllianzGI
Allianz Best Styles Euroland Equity	AllianzGI
Allianz Best Styles Europe Equity	AllianzGI
Allianz Best Styles Europe Equity SRI	AllianzGI
Allianz Best Styles Global AC Equity	AllianzGI
Allianz Best Styles Global Equity	AllianzGI
Allianz Best Styles Global Equity SRI	AllianzGI
Allianz Best Styles Pacific Equity	AllianzGI
Allianz Best Styles US Equity	AllianzGI
Allianz Better World Defensive	co-managed by AllianzGI (incl its France Branch) and AllianzGI UK

Sub-Fund Name	Investment Manager / Sub-Investment Manager, Investment Advisor
Allianz Better World Dynamic	co-managed by AllianzGI (incl its France Branch) and AllianzGI UK
Allianz Better World Moderate	co-managed by AllianzGI (incl its France Branch) and AllianzGI UK
Allianz Blockchain Opportunities	Voya IM
Allianz Capital Plus	AllianzGI
Allianz Capital Plus Global	AllianzGI
Allianz China A Opportunities	AllianzGI AP
Allianz China A-Shares	AllianzGI AP
Allianz China Equity	AllianzGI AP
Allianz China Future Technologies	AllianzGI AP
Allianz China Healthy Living	AllianzGI AP
Allianz China Multi Income Plus	co-managed by AllianzGI AP and AllianzGI Singapore
Allianz China Strategic Bond	co-managed by AllianzGI AP and AllianzGI Singapore
Allianz China Thematica	AllianzGI AP
Allianz Clean Planet	co-managed by AllianzGI and AllianzGI AP
Allianz Climate Transition	AllianzGI France Branch
Allianz Convertible Bond	AllianzGI France Branch
Allianz Coupon Select Plus V	AllianzGI
Allianz Coupon Select Plus VI	AllianzGI
Allianz Credit Opportunities	AllianzGI France Branch
Allianz Credit Opportunities Plus	AllianzGI France Branch
Allianz Cyber Security	Voya IM
Allianz Dynamic Allocation Plus Equity	co-managed by AllianzGI and AllianzGI UK
Allianz Dynamic Asian High Yield Bond	co-managed by AllianzGI AP and AllianzGI Singapore
Allianz Dynamic Commodities	AllianzGI
Allianz Dynamic Multi Asset Strategy SRI 15	AllianzGI
Allianz Dynamic Multi Asset Strategy SRI 50	AllianzGI
Allianz Dynamic Multi Asset Strategy SRI 75	AllianzGI
Allianz Emerging Asia Equity	AllianzGI AP
Allianz Emerging Europe Equity	AllianzGI
Allianz Emerging Markets Equity	AllianzGI
Allianz Emerging Markets Equity Opportunities	AllianzGI
Allianz Emerging Markets Equity SRI	AllianzGI
Allianz Emerging Markets Multi Asset Income	co-managed by AllianzGI Japan and AllianzGI Singapore AllianzGI Japan and AllianzGI Singapore acting in their function as the Sub-Fund's lead investment managers have partially delegated the investment management to AllianzGI, AllianzGI UK and AllianzGI AP acting as sub-investment manager. Such delegations include research and selection of Emerging Market Equities and Emerging Market Bonds

Sub-Fund Name	Investment Manager / Sub-Investment Manager, Investment Advisor
Allianz Emerging Markets Select Bond	co-managed by AllianzGI UK and AllianzGI AP
Allianz Emerging Markets Short Duration Bond	co-managed by AllianzGI UK and AllianzGI AP
Allianz Emerging Markets Sovereign Bond	AllianzGI UK
Allianz Emerging Markets SRI Bond	AllianzGI UK
Allianz Emerging Markets SRI Corporate Bond	co-managed by AllianzGI UK and AllianzGI AP
Allianz Enhanced All China Equity	co-managed by AllianzGI and AllianzGI AP
Allianz Enhanced Short Term Euro	AllianzGI
Allianz Euro Balanced	AllianzGI (incl its Netherlands Branch)
Allianz Euro Bond	AllianzGI France Branch
Allianz Euro Bond Short Term 1-3 Plus	AllianzGI France Branch
Allianz Euro Credit SRI	co-managed by AllianzGI (incl its France Branch) and AllianzGI UK
Allianz Euro Government Bond	AllianzGI (incl its Belgium Branch, France Branch and Netherlands Branch)
Allianz Euro High Yield Bond	AllianzGI France Branch
Allianz Euro High Yield Defensive	AllianzGI France Branch
Allianz Euro Inflation-linked Bond	AllianzGI France Branch
Allianz Euroland Equity Growth	AllianzGI
Allianz Europe Equity Growth	co-managed by AllianzGI and AllianzGI UK
Allianz Europe Equity Growth Select	AllianzGI
Allianz Europe Equity powered by Artificial Intelligence	AllianzGI
Allianz Europe Equity SRI	AllianzGI France Branch
Allianz Europe Equity Value	AllianzGI
Allianz Europe Income and Growth	AllianzGI (incl its France Branch)
Allianz Europe Mid Cap Equity	AllianzGI
Allianz Europe Small and Micro Cap Equity	co-managed by AllianzGI and AllianzGI UK
Allianz Europe Small Cap Equity	AllianzGI
Allianz European Bond RC	AllianzGI France Branch
Allianz European Equity Dividend	AllianzGI
Allianz Fixed Income Macro	AllianzGI UK
Allianz Flexi Asia Bond	co-managed by AllianzGI AP and AllianzGI Singapore
Allianz Floating Rate Notes Plus	AllianzGI France Branch
Allianz Food Security	AllianzGI UK
Allianz GEM Equity High Dividend	AllianzGI
Allianz German Equity	AllianzGI

Sub-Fund Name	Investment Manager / Sub-Investment Manager, Investment Advisor
Allianz German Small and Micro Cap	AllianzGI
Allianz Global Aggregate Bond	AllianzGI UK
Allianz Global Artificial Intelligence	Voya IM
Allianz Global Capital Plus	AllianzGI
Allianz Global Credit SRI	co-managed by AllianzGI and AllianzGI UK
Allianz Global Diversified Dividend	AllianzGI
Allianz Global Dividend	co-managed by AllianzGI and AllianzGI UK
Allianz Global Dynamic Multi Asset Income	co-managed by AllianzGI, AllianzGI UK and AllianzGI Singapore
Allianz Global Emerging Markets Equity Dividend	AllianzGI
Allianz Global Equity Growth	AllianzGI
Allianz Global Equity Insights	Voya IM
Allianz Global Equity powered by Artificial Intelligence	AllianzGI
Allianz Global Equity Unconstrained	AllianzGI
Allianz Global Floating Rate Notes Plus	co-managed by AllianzGI and AllianzGI UK
Allianz Global Government Bond	AllianzGI UK
Allianz Global High Yield	AllianzGI UK
Allianz Global Hi-Tech Growth	Voya IM
Allianz Global Income	Voya IM
Allianz Global Inflation-Linked Bond	AllianzGI France Branch
Allianz Global Intelligent Cities Income	Voya IM
Allianz Global Metals and Mining	co-managed by AllianzGI and AllianzGI AP
Allianz Global Multi-Asset Credit	AllianzGI UK
Allianz Global Multi-Asset Credit SRI	AllianzGI UK
Allianz Global Multi Asset Sustainability Balanced	co-managed by AllianzGI, AllianzGI UK, AllianzGI AP, AllianzGI Japan and AllianzGI Singapore
Allianz Global Multi Asset Sustainability Conservative	co-managed by AllianzGI, AllianzGI UK, AllianzGI AP, AllianzGI Japan and AllianzGI Singapore
Allianz Global Multi Asset Sustainability Growth	co-managed by AllianzGI, AllianzGI UK, AllianzGI AP, AllianzGI Japan and AllianzGI Singapore
Allianz Global Opportunistic Bond	AllianzGI UK
Allianz Global Small Cap Equity	co-managed by AllianzGI and AllianzGI UK AllianzGI acting in its function as one of the Sub-Fund's lead investment managers has partially delegated the investment management to AllianzGI AP acting as sub-investment manager as far as it concerns the respective regional Equity market. In addition, AllianzGI AP has partially delegated the investment management as far as it concerns Japanese Equity markets to AllianzGI Japan acting as a sub-investment manager.
Allianz Global Sustainability	AllianzGI UK
Allianz Global Water	AllianzGI
Allianz Green Bond	co-managed by AllianzGI (incl its France Branch) and AllianzGI UK

Sub-Fund Name	Investment Manager / Sub-Investment Manager, Investment Advisor
Allianz Green Future	AllianzGI
Allianz Green Transition Bond	co-managed by AllianzGI (incl its France Branch) and AllianzGI UK
Allianz High Dividend Asia Pacific Equity	AllianzGI AP
Allianz HKD Income	AllianzGI AP
Allianz Hong Kong Equity	AllianzGI AP
Allianz Income and Growth	Voya IM
Allianz India Equity	AllianzGI AP
Allianz Indonesia Equity	AllianzGI AP
Allianz Japan Equity	AllianzGI AP AllianzGI AP acting in its function as the Sub-Fund's lead investment manager has delegated the investment management to AllianzGI Japan acting as sub-investment manager.
Allianz Japan Smaller Companies Equity	AllianzGI Japan
Allianz Laufzeitfonds	co-managed by AllianzGI (incl its France Branch) and AllianzGI UK
Allianz Little Dragons	AllianzGI AP
Allianz Metaverse	Voya IM
Allianz Multi Asset Long / Short	co-managed by AllianzGI and AllianzGI UK
Allianz Multi Asset Opportunities	co-managed by AllianzGI and AllianzGI UK
Allianz Multi Asset Risk Premia	co-managed by AllianzGI and AllianzGI Japan
Allianz Oriental Income	AllianzGI AP
Allianz Pet and Animal Wellbeing	AllianzGI
Allianz Positive Change	AllianzGI UK
Allianz Premium Champions	AllianzGI
Allianz Renminbi Fixed Income	co-managed by AllianzGI AP and AllianzGI Singapore
Allianz SDG Euro Credit	co-managed by AllianzGI (incl its France Branch) and AllianzGI UK
Allianz SDG Global Equity	AllianzGI
Allianz Select Income and Growth	Voya IM
Allianz Selection Alternative	AllianzGI France Branch
Allianz Selection Fixed Income	AllianzGI France Branch
Allianz Selection Small and Mid Cap Equity	AllianzGI France Branch
Allianz Selective Global High Income	AllianzGI UK
Allianz SGD Income	AllianzGI Singapore
Allianz Short Duration Global Bond SRI	co-managed by AllianzGI and AllianzGI UK
Allianz Smart Energy	co-managed by AllianzGI and AllianzGI AP
Allianz Social Conviction Equity	AllianzGI France Branch
Allianz Strategic Bond	AllianzGI UK
Allianz Strategy Select 30	AllianzGI
Allianz Strategy Select 50	AllianzGI

Sub-Fund Name	Investment Manager / Sub-Investment Manager, Investment Advisor
Allianz Strategy Select 75	AllianzGI
Allianz Strategy4Life 30	AllianzGI
Allianz Strategy4Life 50	AllianzGI
Allianz Strategy4Life 75	AllianzGI
Allianz Strategy4Life Europe 40	AllianzGI
Allianz Sustainable Health Evolution	AllianzGI UK
Allianz Sustainable Multi Asset 75	AllianzGI
Allianz Systematic Enhanced US Equity SRI	AllianzGI
Allianz Target Maturity Euro Bond I	co-managed by AllianzGI (incl its France Branch) and AllianzGI UK
Allianz Target Maturity Euro Bond II	AllianzGI (incl its France Branch) (valid until 19 October 2023) co-managed by AllianzGI (incl its France Branch) and AllianzGI UK (valid as of 20 October 2023)
Allianz Thematica	AllianzGI
Allianz Total Return Asian Equity	AllianzGI AP
Allianz Treasury Short Term Plus Euro	AllianzGI
Allianz Trend and Brands	AllianzGI (incl its Italy Branch)
Allianz UK Government Bond	AllianzGI UK
Allianz Unconstrained Multi Asset Strategy	co-managed by AllianzGI and AllianzGI UK
Allianz US Equity Fund	Voya IM
Allianz US Equity Plus	Voya IM
Allianz US Equity powered by Artificial Intelligence	AllianzGI
Allianz US High Yield	Voya IM
Allianz US Investment Grade Credit	Voya IM
Allianz US Large Cap Value	Voya IM
Allianz US Short Duration High Income Bond	Voya IM
Allianz Volatility Strategy Fund	co-managed by AllianzGI and AllianzGI UK
IndexManagement Balance	AllianzGI
IndexManagement Chance	AllianzGI
IndexManagement Substanz	AllianzGI
IndexManagement Wachstum	AllianzGI

Appendix 6

Investor Profile and other Provisions / Restrictions or Additional Information

The following note applies to all Sub-Funds:

- In terms of risk assessment, the Sub-Funds are assigned to a certain risk class on a scale of 1 (conservative; very low to low expectation of returns) to 7 (very tolerant of risk; highest expectation of returns) which is published on the website <https://regulatory.allianzgi.com> and will be provided in the relevant key information documents.

Allianz ActiveInvest Balanced

Investor Profile

Allianz ActiveInvest Balanced is aimed at investors who pursue the objective of general capital formation/asset optimisation and/or above-average participation in price changes. It may not be suitable for investors who wish to withdraw their capital from the Sub-Fund within a period of 4 years. Allianz ActiveInvest Balanced is aimed at investors with basic knowledge and/or experience of financial products. Prospective investors should be capable of bearing a financial loss and should not attach any importance to capital protection.

Other Provisions / Restrictions / Additional Information

- Share Class type C/CT may only be acquired by Allianz SE, its subsidiaries and their clients. Shares of all other Share Classes may only be acquired by Allianz SE and its subsidiaries.
- The minimum subscription amount for the investment in Shares of all types of I/IT and W/WT share classes (after deduction of any Sales Charge) is EUR 25 million. In certain cases, the Management Company has discretion to permit lower minimum investments.

Allianz ActiveInvest Defensive

Investor Profile

Allianz ActiveInvest Defensive is aimed at investors who pursue the objective of general capital formation/asset optimisation and/or above-average participation in price changes. It may not be suitable for investors who wish to withdraw their capital from the Sub-Fund within a period of 3 years. Allianz ActiveInvest Defensive is aimed at investors with basic knowledge and/or experience of financial products. Prospective investors should be capable of bearing a financial loss and should not attach any importance to capital protection.

Other Provisions / Restrictions / Additional Information

- Share Class type C/CT may only be acquired by Allianz SE, its subsidiaries and their clients. Shares of all other Share Classes may only be acquired by Allianz SE and its subsidiaries.
- The minimum subscription amount for the investment in Shares of all types of I/IT and W/WT share classes (after deduction of any Sales Charge) is EUR 25 million. In certain cases, the Management Company has discretion to permit lower minimum investments.

Allianz ActiveInvest Dynamic

Investor Profile

Allianz ActiveInvest Dynamic is aimed at investors who pursue the objective of general capital formation/asset optimisation and/or above-average participation in price changes. It may not be suitable for investors who wish to withdraw their capital from the Sub-Fund within a period of 4 years. Allianz ActiveInvest Dynamic is aimed at investors with basic knowledge and/or experience of financial products. Prospective investors should be capable of bearing a financial loss and should not attach any importance to capital protection.

Other Provisions / Restrictions / Additional Information

- Share Class type C/CT may only be acquired by Allianz SE, its subsidiaries and their clients. Shares of all other Share Classes may only be acquired by Allianz SE and its subsidiaries.
- The minimum subscription amount for the investment in Shares of all types of I/IT and W/WT share classes (after deduction of any Sales Charge) is EUR 25 million. In certain cases, the Management Company has discretion to permit lower minimum investments.

Allianz Advanced Fixed Income Euro

Investor Profile

Allianz Advanced Fixed Income Euro is aimed at investors who prioritise safety and/or pursue the objective of general capital formation/asset optimisation. It may not be suitable for investors who wish to invest their capital in the Sub-Fund within a period of 3 years. Allianz Advanced Fixed Income Euro is aimed at investors with basic knowledge and/or experience of financial products. Prospective investors should be capable of bearing a financial loss and should not attach any importance to capital protection.

Other Provisions / Restrictions / Additional Information

- Shares of Share Class IT8 (EUR) may only be acquired for clients domiciled in Italy which have signed a discretionary investment management agreement with the Management Company.
- Shares of Share Classes W14 (EUR) and WT14 may only be acquired by Banca Aletti Italy.
- The minimum subscription amount for the investment in Shares of Share Classes W14 and WT14 (after deduction of any Sales Charge) is EUR 250 million. In certain cases, the Management Company has discretion to permit lower minimum investments.
- Shares of Share Classes W33 (EUR) and WT33 (EUR) may only be acquired by BNP Paribas Fortis and its subsidiaries.
- The minimum subscription amount for the investment in Shares of Share Classes W33 and WT33 (after deduction of any Sales Charge) is EUR 100 million. In certain cases, the Management Company has discretion to permit lower minimum investments.
- Shares of Share Classes C2 and CT2 may only be acquired by investors who are clients of Hellenic Bank or its affiliates.
- The minimum subscription amount for the investment in Shares of the Share Class C2 and CT2 (after deduction of any Sales Charge) is EUR 1 million or equivalent in other currencies. In certain cases, the Management Company has discretion to permit lower minimum investments.

Allianz Advanced Fixed Income Global

Investor Profile

Allianz Advanced Fixed Income Global is aimed at investors who pursue the objective of general capital formation/asset optimisation. It may not be suitable for investors who wish to invest their capital in the Sub-Fund within a period of 3 years. Allianz Advanced Fixed Income Global is aimed at investors with basic knowledge and/or experience of financial products. Prospective investors should be capable of bearing a financial loss and should not attach any importance to capital protection.

Other Provisions / Restrictions / Additional Information

-

Allianz Advanced Fixed Income Global Aggregate

Investor Profile

Allianz Advanced Fixed Income Global Aggregate is aimed at investors who pursue the objective of general capital formation/asset optimisation. It may not be suitable for investors who wish to withdraw their capital from the Sub-Fund within a period of 3 years. Allianz Advanced Fixed Income Global Aggregate is aimed at investors with basic knowledge and/or experience of financial products. Prospective investors should be capable of bearing a financial loss and should not attach any importance to capital protection.

Other Provisions / Restrictions / Additional Information

- Shares of Share Classes W33 (EUR) and WT33 (EUR) may only be acquired by BNP Paribas Fortis and its subsidiaries.
- The minimum subscription amount for the investment in Shares of Share Classes W33 and WT33 (after deduction of any Sales Charge) is EUR 100 million. In certain cases, the Management Company has discretion to permit lower minimum investments.

Allianz Advanced Fixed Income Short Duration

Investor Profile

Allianz Advanced Fixed Income Short Duration is aimed at investors who prioritise safety and/or pursue the objective of general capital formation/asset optimisation. It may not be suitable for investors who wish to withdraw their capital from the Sub-Fund within a period of 2 years. Allianz Advanced Fixed Income Short Duration is aimed at investors with basic knowledge and/or experience of financial products. Prospective investors should be capable of bearing a financial loss and should not attach any importance to capital protection.

Other Provisions / Restrictions / Additional Information

- Share Class P (EUR) contains the additional name "Euro Reserve Plus WM" which is placed prior to "P (EUR)".
- The minimum subscription amount for the investment in Shares of the Share Class Euro Reserve Plus WM P (EUR) (after deduction of any Sales Charge) is EUR 100,000. In certain cases, the Management Company has discretion to permit lower minimum investments.
- Share Class type A may contain the additional name "Euro Reserve Plus P+G" which is placed prior to the Share Class type.
- Shares of Share Classes R10 and RT10 may only be acquired by investors who are clients of UBS Switzerland AG and its affiliates or Singular Bank S.A.U. and its affiliates, and who have individual fee arrangements with UBS Switzerland AG and its affiliates or Singular Bank S.A.U. and its affiliates.
- The minimum subscription amounts for the investment in Shares in Share Classes R10 (EUR) and RT10 (EUR) (after deduction of any Sales Charge) is EUR 10 million. In certain cases, the Management Company has discretion to permit lower minimum investments.

Allianz All China Equity

Investor Profile

Allianz All China Equity is aimed at investors who pursue the objective of general capital formation/asset optimisation and/or above-average participation in price changes. It may not be suitable for investors who wish to withdraw their capital from the Sub-Fund within a period of 5 years. Allianz All China Equity is aimed at investors with basic knowledge and/or experience of financial products. Prospective investors should be capable of bearing a financial loss and should not attach any importance to capital protection.

Other Provisions / Restrictions / Additional Information

- The Subscription Price of the Shares must be received by the Company in cleared funds within three Valuation Days after the calculation of the Subscription Price. The Redemption Price will be paid out within three Valuation Days after calculation the Redemption Price.

Allianz Alternative Investment Strategies

Investor Profile

Allianz Alternative Investment Strategies is aimed at investors who pursue the objective of general capital formation/asset optimisation and/or above-average participation in price changes. It may not be suitable for investors who wish to withdraw their capital from the Sub-Fund within a period of 5 years. Allianz Alternative Investment Strategies is aimed at investors with basic knowledge and/or experience of financial products. Prospective investors should be capable of bearing a financial loss and should not attach any importance to capital protection.

Other Provisions / Restrictions / Additional Information

- The Subscription Price of the Shares must be received by the Company in cleared funds within three Valuation Days after the calculation of the Subscription Price, applicable for all Share Classes. The Redemption Price will be paid out within three Valuation Days after calculation the Redemption Price, applicable for all Share Classes.
- The minimum subscription amount for the investment in Shares in Share Classes P3 and PT3 (after deduction of any Sales Charge) is EUR 3 million or equivalent in other currencies. In certain cases, the Management Company has discretion to permit lower minimum investments.

Allianz American Income

Investor Profile

Allianz American Income is aimed at investors who pursue the objective of general capital formation/asset optimisation. It may not be suitable for investors who wish to withdraw their capital from the Sub-Fund within a period of 4 years. Allianz American Income is aimed at investors with basic knowledge and/or experience of financial products. Prospective investors should be capable of bearing a financial loss and should not attach any importance to capital protection.

Other Provisions / Restrictions / Additional Information

-

Allianz Asian Multi Income Plus

Investor Profile

Allianz Asian Multi Income Plus is aimed at investors who pursue the objective of general capital formation/asset optimisation and/or above-average participation in price changes. It may not be suitable for investors who wish to withdraw their capital from the Sub-Fund within a period of 4 years. Allianz Asian Multi Income Plus is aimed at investors with basic knowledge and/or experience of financial products. Prospective investors should be capable of bearing a financial loss and should not attach any importance to capital protection.

Other Provisions / Restrictions / Additional Information

- The Subscription Price of the Shares must be received by the Company in cleared funds within three Valuation Days after the calculation of the Subscription Price. The Redemption Price will be paid out within three Valuation Days after calculation the Redemption Price.

Allianz Asian Small Cap Equity

Investor Profile

Allianz Asian Small Cap Equity is aimed at investors who pursue the objective of general capital formation/asset optimisation and/or above-average participation in price changes. It may not be suitable for investors who wish to withdraw their capital from the Sub-Fund within a period of 5 years. Allianz Asian Small Cap Equity is aimed at investors with basic knowledge and/or experience of financial products. Prospective investors should be capable of bearing a financial loss and should not attach any importance to capital protection.

Other Provisions / Restrictions / Additional Information

- Share classes containing the additional denomination "2" may only be acquired by investors who are either domiciled in or are permanent residents of an Asian country, Australia or New Zealand.
- The minimum subscription amount for the investment in Shares in Share Classes W7 (USD) and WT7 (USD) (after deduction of any Sales Charge) is USD 250 million. In certain cases, the Management Company has discretion to permit lower minimum investments.
- Shares of Share Classes W7 and WT7 may only be acquired by Pension Funds domiciled in Latin America.

Allianz Best Ideas 2025

Investor Profile

Allianz Best Ideas 2025 is aimed at investors who pursue the objective of general capital formation/asset optimisation and/or above-average participation in price changes. It may not be suitable for investors who wish to withdraw their capital from the Sub-Fund prior to the maturity date of the Sub-Fund, i.e., not to withdraw their capital before 16 January 2025. Allianz Best Ideas 2025 is aimed at investors with basic knowledge and/or experience of financial products. Prospective investors should be capable of bearing a financial loss and should not attach any importance to capital protection.

Other Provisions / Restrictions / Additional Information

- A placement fee of up to 2.00% of initial NAV at Sub-Fund's launch date for all types of share classes is levied on the Sub-Fund and paid out in a single instalment after the end of the subscription period. This Placement Fee is then amortized over a 5-year period of the Sub-Fund. The Management Company has discretion to levy a lower Placement Fee.
- An exit fee of up to 2.00% of initial NAV at Sub-Fund's launch date for all types of share classes will be applied after the end of the subscription period. The exit fee will remain in the Sub-Fund and is calculated as a fix amount per Share of a Share Class. The amount will be reduced by 0.40% of the initial NAV at launch date on an annual basis.
- The Management Company intends to limit subscriptions such that the Sub-Fund or selected share classes will be closed for subscriptions after the end of a subscription period to be determined yet. This closure for subscriptions might not necessarily rely on market conditions and can be decided on a discretionary basis by the Management Company.

Allianz Best of Managers

Investor Profile

Allianz Best of Managers is aimed at investors who pursue the objective of general capital formation/asset optimisation and/or above-average participation in price changes. It may not be suitable for investors who wish to withdraw their capital from the Sub-Fund within a period of 3 years. Allianz Best of Managers is aimed at investors with basic knowledge and/or experience of financial products. Prospective investors should be capable of bearing a financial loss and should not attach any importance to capital protection.

Other Provisions / Restrictions / Additional Information

- A placement fee of up to 2.50% of initial NAV at Sub-Fund's launch date for all types of share classes is levied on the Sub-Fund and paid out in a single instalment after the end of the subscription period. This Placement Fee is then amortized over a 5-year period of the Sub-Fund. The Management Company has discretion to levy a lower Placement Fee.
- An exit fee of up to 2.50% of initial NAV at Sub-Fund's launch date for all types of share classes will be applied after the end of the subscription period. The exit fee will remain in the Sub-Fund and is calculated as a fix amount per Share of a Share Class. The amount will be reduced by 0.25% of the initial NAV at launch date on a semi-annual basis.

- The Management Company intends to limit subscriptions such that the Sub-Fund or selected share classes will be closed for subscriptions after the end of a subscription period to be determined yet. This closure for subscriptions might not necessarily rely on market conditions and can be decided on a discretionary basis by the Management Company.
- The balanced portfolio is constructed in such a way to offer attractive risk adjusted returns over the recommended holding period, namely the placement fee amortization period corresponding to the period during which exit fees are applicable.
- The Management Company has the intention – but is legally not obliged – to liquidate or merge the Sub-Fund into another UCITS or UCI after 5 to 9 years after the Sub-Fund's launch date.

Allianz Best Styles Euroland Equity

Investor Profile

Allianz Best Styles Euroland Equity is aimed at investors who pursue the objective of general capital formation/asset optimisation and/or above-average participation in price changes. It may not be suitable for investors who wish to withdraw their capital from the Sub-Fund within a period of 5 years. Allianz Best Styles Euroland Equity is aimed at investors with basic knowledge and/or experience of financial products. Prospective investors should be capable of bearing a financial loss and should not attach any importance to capital protection.

Other Provisions / Restrictions / Additional Information

- Shares of Share Class P14 and PT14 may only be acquired with the consent of the Management Company.
- No trail commissions may be paid to any sales partners in relation to Share Classes P14 and PT14.
- Shares of Share Class IT8 (EUR) may only be acquired for clients domiciled in Italy which have signed a discretionary investment management agreement with the Management Company.

Allianz Best Styles Europe Equity

Investor Profile

Allianz Best Styles Europe Equity is aimed at investors who pursue the objective of general capital formation/asset optimisation and/or above-average participation in price changes. It may not be suitable for investors who wish to withdraw their capital from the Sub-Fund within a period of 5 years. Allianz Best Styles Europe Equity is aimed at investors with basic knowledge and/or experience of financial products. Prospective investors should be capable of bearing a financial loss and should not attach any importance to capital protection.

Other Provisions / Restrictions / Additional Information

- The minimum subscription amount for the investment in Shares of the Share Class I2 (EUR) and IT2 (EUR) (after deduction of any Sales Charge) is EUR 500,000. In certain cases, the Management Company has discretion to permit lower minimum investments.
- Shares of Share Classes I4 (EUR) and IT4 (EUR) may only be acquired by Allianz Nederland Levensverzekering and/or Allianz Benelux.
- Shares of Share Classes IT8 (H-EUR) may only be acquired for clients domiciled in Italy which have signed a discretionary investment management agreement with the Management Company.
- Shares of Share Class P14 and PT14 may only be acquired with the consent of the Management Company.
- No trail commissions may be paid to any sales partners in relation to Share Classes P14 and PT14.
- Shares of Share Classes W33 (EUR) and WT33 (EUR) may only be acquired by BNP Paribas Fortis and its subsidiaries.
- The minimum subscription amount for the investment in Shares of Share Classes W33 and WT33 (after deduction of any Sales Charge) is EUR 100 million. In certain cases, the Management Company has discretion to permit lower minimum investments.

Allianz Best Styles Europe Equity SRI

Investor Profile

Allianz Best Styles Europe Equity SRI is aimed at investors who pursue the objective of general capital formation/asset optimisation and/or above-average participation in price changes. It may not be suitable for investors who wish to withdraw their capital from the Sub-Fund within a period of 5 years. Allianz Best Styles Europe Equity SRI is aimed at investors with basic knowledge and/or experience of financial products. Prospective investors should be capable of bearing a financial loss and should not attach any importance to capital protection.

Other Provisions / Restrictions / Additional Information

- The minimum subscription amount for the investment in Shares of the Share Class I2 (EUR) and IT2 (EUR) (after deduction of any Sales Charge) is EUR 500,000. In certain cases, the Management Company has discretion to permit lower minimum investments.
- Shares of Share Classes I4 (EUR) and IT4 (EUR) may only be acquired by Allianz Nederland Levensverzekering and/or Allianz Benelux.
- Shares of Share Classes IT8 (H-EUR) may only be acquired for clients domiciled in Italy which have signed a discretionary investment management agreement with the Management Company.
- Shares of Share Class P14 and PT14 may only be acquired with the consent of the Management Company.
- No trail commissions may be paid to any sales partners in relation to Share Classes P14 and PT14.
- Shares of Share Classes W33 (EUR) and WT33 (EUR) may only be acquired by BNP Paribas Fortis and its subsidiaries.

- The minimum subscription amount for the investment in Shares of Share Classes W33 and WT33 (after deduction of any Sales Charge) is EUR 100 million. In certain cases, the Management Company has discretion to permit lower minimum investments.

Allianz Best Styles Global AC Equity

Investor Profile

Allianz Best Styles Global AC Equity is aimed at investors who pursue the objective of general capital formation/asset optimisation and/or above-average participation in price changes. It may not be suitable for investors who wish to withdraw their capital from the Sub-Fund within a period of 5 years. Allianz Best Styles Global AC Equity is aimed at investors with basic knowledge and/or experience of financial products. Prospective investors should be capable of bearing a financial loss and should not attach any importance to capital protection.

Other Provisions / Restrictions / Additional Information

- Shares of Share Class P14 and PT14 may only be acquired with the consent of the Management Company.
- No trail commissions may be paid to any sales partners in relation to Share Classes P14 and PT14.
- The minimum subscription amounts for the investment in Shares in Share Classes W6 and WT6 (after deduction of any Sales Charge) are AUD 750 million, CAD 750 million, CHF 1 billion, CZK 15 billion, DKK 5 billion, EUR 500 million, GBP 500 million, HKD 5 billion, HUF 125 billion, JPY 100 billion, MXN 7,5 billion, NOK 4 billion, NZD 750 million, PLN 2 billion, RMB 5 billion, SEK 5 billion, SGD 1 billion, TRY 1,25 billion, USD 500 million and ZAR 7,5 million. In certain cases, the Management Company has discretion to permit lower minimum investments.
- The minimum subscription amount for the investment in Shares in Share Classes P7 and PT7 (after deduction of any Sales Charge) is EUR 10 million or equivalent in other currencies. In certain cases, the Management Company has discretion to permit lower minimum investments.

Allianz Best Styles Global Equity

Investor Profile

Allianz Best Styles Global Equity is aimed at investors who pursue the objective of general capital formation/asset optimisation and/or above-average participation in price changes. It may not be suitable for investors who wish to withdraw their capital from the Sub-Fund within a period of 5 years. Allianz Best Styles Global Equity is aimed at investors with basic knowledge and/or experience of financial products. Prospective investors should be capable of bearing a financial loss and should not attach any importance to capital protection.

Other Provisions / Restrictions / Additional Information

- Shares of Share Classes IT8 (H-EUR) may only be acquired for clients domiciled in Italy which have signed a discretionary investment management agreement with the Management Company.
- Shares of Share Class P14 and PT14 may only be acquired with the consent of the Management Company.
- No trail commissions may be paid to any sales partners in relation to Share Classes P14 and PT14.
- Shares of Share Class W8 (USD) may only be acquired by Pension Funds domiciled in Oman.
- Shares of Share Classes W33 (EUR) and WT33 (EUR) may only be acquired by BNP Paribas Fortis and its subsidiaries.
- The minimum subscription amount for the investment in Shares of the Share Class W8 (USD) is USD 150,000,000. In certain cases, the Management Company has discretion to permit lower minimum investments.
- The minimum subscription amount for the investment in Shares of Share Classes W33 and WT33 (after deduction of any Sales Charge) is EUR 100 million. In certain cases, the Management Company has discretion to permit lower minimum investments.

Allianz Best Styles Global Equity SRI

Investor Profile

Allianz Best Styles Global Equity SRI is aimed at investors who pursue the objective of general capital formation/asset optimisation and/or above-average participation in price changes. It may not be suitable for investors who wish to withdraw their capital from the Sub-Fund within a period of 5 years. Allianz Best Styles Global Equity SRI is aimed at investors with basic knowledge and/or experience of financial products. Prospective investors should be capable of bearing a financial loss and should not attach any importance to capital protection.

Other Provisions / Restrictions / Additional Information

- Shares of Share Classes IT8 (H-EUR) may only be acquired for clients domiciled in Italy which have signed a discretionary investment management agreement with the Management Company.
- Shares of Share Class P14 and PT14 may only be acquired with the consent of the Management Company.
- No trail commissions may be paid to any sales partners in relation to Share Classes P14 and PT14.
- Shares of Share Class W8 (USD) may only be acquired by Pension Funds domiciled in Oman.
- Shares of Share Classes W33 (EUR) and WT33 (EUR) may only be acquired by BNP Paribas Fortis and its subsidiaries.
- The minimum subscription amount for the investment in Shares of the Share Class W8 (USD) is USD 150,000,000. In certain cases, the Management Company has discretion to permit lower minimum investments.
- The minimum subscription amount for the investment in Shares of Share Classes W33 and WT33 (after deduction of any Sales Charge) is EUR 100 million. In certain cases, the Management Company has discretion to permit lower minimum investments.

Allianz Best Styles Pacific Equity

Investor Profile

Allianz Best Styles Pacific Equity is aimed at investors who pursue the objective of general capital formation/asset optimisation and/or above-average participation in price changes. It may not be suitable for investors who wish to withdraw their capital from the Sub-Fund within a period of 5 years. Allianz Best Styles Pacific Equity is aimed at investors with basic knowledge and/or experience of financial products. Prospective investors should be capable of bearing a financial loss and should not attach any importance to capital protection.

Other Provisions / Restrictions / Additional Information

- The minimum subscription amount for the investment in Shares of the Share Class I2 (EUR) and IT2 (EUR) (after deduction of any Sales Charge) is EUR 500,000. In certain cases, the Management Company has discretion to permit lower minimum investments.
- The minimum subscription amount for the investment in Shares of the Share Class I4 (EUR) and IT4 (EUR) (after deduction of any Sales Charge) is EUR 8 million. In certain cases, the Management Company has discretion to permit lower minimum investments.
- Shares of Share Classes IT8 (H-EUR) may only be acquired for clients domiciled in Italy which have signed a discretionary investment management agreement with the Management Company.

Allianz Best Styles US Equity

Investor Profile

Allianz Best Styles US Equity is aimed at investors who pursue the objective of general capital formation/asset optimisation and/or above-average participation in price changes. It may not be suitable for investors who wish to withdraw their capital from the Sub-Fund within a period of 5 years. Allianz Best Styles US Equity is aimed at investors with basic knowledge and/or experience of financial products. Prospective investors should be capable of bearing a financial loss and should not attach any importance to capital protection.

Other Provisions / Restrictions / Additional Information

- Shares of Share Class P14 and PT14 may only be acquired with the consent of the Management Company.
- No trail commissions may be paid to any sales partners in relation to Share Classes P14 and PT14.
- The minimum subscription amount for the investment in Shares of the Share Class I2 (EUR) and IT2 (EUR) (after deduction of any Sales Charge) is EUR 500,000. In certain cases, the Management Company has discretion to permit lower minimum investments.
- The minimum subscription amount for the investment in Shares of the Share Class I4 (EUR) and IT4 (EUR) (after deduction of any Sales Charge) is EUR 5 million. In certain cases, the Management Company has discretion to permit lower minimum investments.
- Shares of Share Classes IT8 (H-EUR) may only be acquired for clients domiciled in Italy which have signed a discretionary investment management agreement with the Management Company.
- The minimum subscription amount for the investment in Shares of the Share Class P2 (USD) (after deduction of any Sales Charge) is USD 3 million. In certain cases, the Management Company has discretion to permit lower minimum investments.
- The minimum subscription amount for the investment in Shares of the Share Class CT2 (USD) (after deduction of any Sales Charge) is USD 10,000. In certain cases, the Management Company has discretion to permit lower minimum investments.

Allianz Better World Defensive

Investor Profile

Allianz Better World Defensive is aimed at investors who pursue the objective of general capital formation/asset optimisation. It may not be suitable for investors who wish to withdraw their capital from the Sub-Fund within a period of 3 years. Allianz Better World Defensive is aimed at investors with basic knowledge and/or experience of financial products. Prospective investors should be capable of bearing a financial loss and should not attach any importance to capital protection.

Other Provisions / Restrictions / Additional Information

- Placement fee of up to 2.50% of Share Classes C6/CT6's and W6/WT6's initial Net Asset Value is levied at the launch date of Share Classes C6/CT6 and W6/WT6 and paid out in a single instalment within five months of the Share Classes C6/CT6's and W6/WT6's launch date. This Placement Fee is then amortized over a 5-year period of the Sub-Fund. The Management Company has discretion to levy a lower Placement Fee.
- An exit fee of up to 2.50% of Share Classes C6/CT6's and W6/WT6's initial Net Asset Value is levied at the launch of Share Classes C6/CT6 and W6/WT6. The exit fee will remain in the Share Classes C6/CT6 and W6/WT6 and is calculated as a fix amount per Share of Share Classes C6/CT6 and W6/WT6. The amount will be reduced by up to 0.25 % of the initial NAV at launch date on a semi-annual basis.
- Share Class type C2/CT2 may only be acquired by Allianz SE, its subsidiaries and their clients.
- Shares of Share Classes I2 (EUR) and IT2 (EUR) may only be acquired by Allianz Lebensversicherungs AG or its subsidiaries.

Allianz Better World Dynamic

Investor Profile

Allianz Better World Dynamic is aimed at investors who pursue the objective of general capital formation/asset optimisation and/ or above-average participation in price changes. It may not be suitable for investors who wish to withdraw their capital from the Sub-Fund within a period of 4 years. Allianz Better World Dynamic is aimed at investors with basic knowledge and/or experience of financial products. Prospective investors should be capable of bearing a financial loss and should not attach any importance to capital protection.

Other Provisions / Restrictions / Additional Information

- Placement fee of up to 3.00% of Share Classes C6/CT6's and W6/WT6's initial Net Asset Value is levied at the launch date of Share Classes C6/CT6 and W6/WT6 and paid out in a single instalment within five months of the Share Classes C6/CT6's and W6/WT6's launch date. This Placement Fee is then amortized over a 5-year period of the Sub-Fund. The Management Company has discretion to levy a lower Placement Fee.
- An exit fee of up to 3.00% of Share Classes C6/CT6's and W6/WT6's initial Net Asset Value is levied at the launch of Share Classes C6/CT6 and W6/WT6. The exit fee will remain in the Share Classes C6/CT6 and W6/WT6 and is calculated as a fix amount per Share of Share Classes C6/CT6 and W6/WT6. The amount will be reduced by up to 0.30% of the initial NAV at launch date on a semi-annual basis.
- Share Class type C2/CT2 may only be acquired by Allianz SE, its subsidiaries and their clients.
- Shares of Share Classes I2 (EUR) and IT2 (EUR) may only be acquired by Allianz Lebensversicherungs AG or its subsidiaries.

Allianz Better World Moderate

Investor Profile

Allianz Better World Moderate is aimed at investors who pursue the objective of general capital formation/asset optimisation and/or above average participation in price changes. It may not be suitable for investors who wish to withdraw their capital from the Sub-Fund within a period of 4 years. Allianz Better World Moderate is aimed at investors with basic knowledge and/or experience of financial products. Prospective investors should be capable of bearing a financial loss and should not attach any importance to capital protection.

Other Provisions / Restrictions / Additional Information

- Placement fee of up to 2.50% of Share Classes C6/CT6's and W6/WT6's initial Net Asset Value is levied at the launch date of Share Classes C6/CT6 and W6/WT6 and paid out in a single instalment within five months of the Share Classes C6/CT6's and W6/WT6's launch date. This Placement Fee is then amortized over a 5-year period of the Sub-Fund. The Management Company has discretion to levy a lower Placement Fee.
- An exit fee of up to 2.50% of Share Classes C6/CT6's and W6/WT6's initial Net Asset Value is levied at the launch of Share Classes C6/CT6 and W6/WT6. The exit fee will remain in the Share Classes C6/CT6 and W6/WT6 and is calculated as a fix amount per Share of Share Classes C6/CT6 and W6/WT6. The amount will be reduced by up to 0.25 % of the initial NAV at launch date on a semi-annual basis.
- Share Class type C2/CT2 may only be acquired by Allianz SE, its subsidiaries and their clients.
- Shares of Share Classes I2 (EUR) and IT2 (EUR) may only be acquired by Allianz Lebensversicherungs AG or its subsidiaries.

Allianz Blockchain Opportunities

Investor Profile

Allianz Blockchain Opportunities is aimed at investors who pursue the objective of general capital formation/asset optimisation and/or above average participation in price changes. It may not be suitable for investors who wish to withdraw their capital from the Sub-Fund within a period of 5 years. Allianz Blockchain Opportunities is aimed at investors with basic knowledge and/or experience of financial products. Prospective investors should be capable of bearing a financial loss and should not attach any importance to capital protection.

Other Provisions / Restrictions / Additional Information

-

Allianz Capital Plus

Investor Profile

Allianz Capital Plus is aimed at investors who pursue the objective of general capital formation/asset optimisation. It may not be suitable for investors who wish to withdraw their capital from the Sub-Fund within a period of 3 years. Allianz Capital Plus is aimed at investors with basic knowledge and/or experience of financial products. Prospective investors should be capable of bearing a financial loss and should not attach any importance to capital protection.

Other Provisions / Restrictions / Additional Information

-

Allianz Capital Plus Global

Investor Profile

Allianz Capital Plus Global is aimed at investors who pursue the objective of general capital formation/asset optimisation. It may not be suitable for investors who wish to withdraw their capital from the Sub-Fund within a period of 3 years. Allianz Capital Plus Global is aimed at investors with basic knowledge and/or experience of financial products. Prospective investors should be capable of bearing a financial loss and should not attach any importance to capital protection.

Other Provisions / Restrictions / Additional Information

- Share Class type C2/CT2 may only be acquired by Deutsche Vermögensberatung AG and its Subsidiaries and Generali Deutschland Lebensversicherung AG.

Allianz China A Opportunities

Investor Profile

Allianz China A Opportunities is aimed at investors who pursue the objective of general capital appreciation/asset optimisation and/or above-average participation in price changes. It may not be suitable for investors who wish to withdraw their capital from the Sub-Fund within a period of 5 years. Allianz China A Opportunities is aimed at investors with basic knowledge and/or experience of financial products. Prospective investors should be capable of bearing a financial loss and should not attach any importance to capital protection.

Other Provisions / Restrictions / Additional Information

- The Subscription Price of the Shares must be received by the Company in cleared funds within two Valuation Days after the calculation of the Subscription Price, applicable for all Share Classes. The Redemption Price will be paid out within four Valuation Days after calculation the Redemption Price, applicable for all Share Classes.
- The minimum subscription amount for the investment in Shares in Share Classes W7 and WT7 (after deduction of any Sales Charge) is USD 250 million or equivalent in other currencies. In certain cases, the Management Company has discretion to permit lower minimum investments.
- Shares of Share Classes W7 and WT7 may only be acquired by Pension Funds domiciled in Latin America.

Allianz China A-Shares

Investor Profile

Allianz China A-Shares is aimed at investors who pursue the objective of general capital appreciation/asset optimisation and/or above-average participation in price changes. It may not be suitable for investors who wish to withdraw their capital from the Sub-Fund within a period of 5 years. Allianz China A-Shares is aimed at investors with basic knowledge and/or experience of financial products. Prospective investors should be capable of bearing a financial loss and should not attach any importance to capital protection.

Other Provisions / Restrictions / Additional Information

- The Subscription Price of the Shares must be received by the Company in cleared funds within two Valuation Days after the calculation of the Subscription Price, applicable for all Share Classes. The Redemption Price will be paid out within four Valuation Days after calculation the Redemption Price, applicable for all Share Classes.
- Shares of Share Classes W4 or WT4 may only be acquired by Deutsche Bank Group
- The minimum subscription amount for the investment in Shares of the Share Class W7 (USD) (after deduction of any Sales Charge) is USD 200 million. In certain cases, the Management Company has discretion to permit lower minimum investments.
- Shares of Share Classes W7 and WT7 may only be acquired by Pension Funds domiciled in Latin America.

Allianz China Equity

Investor Profile

Allianz China Equity is aimed at investors who pursue the objective of general capital formation/asset optimisation and/or above-average participation in price changes. It may not be suitable for investors who wish to withdraw their capital from the Sub-Fund within a period of 5 years. Allianz China Equity is aimed at investors with basic knowledge and/or experience of financial products. Prospective investors should be capable of bearing a financial loss and should not attach any importance to capital protection.

Other Provisions / Restrictions / Additional Information

- The Subscription Price of the Shares must be received by the Company in cleared funds within three Valuation Days after the calculation of the Subscription Price. The Redemption Price will be paid out within three Valuation Days after calculation the Redemption Price.

Allianz China Future Technologies

Investor Profile

Allianz China Future Technologies is aimed at investors who pursue the objective of general capital formation/asset optimisation and/or above-average participation in price changes. It may not be suitable for investors who wish to withdraw their capital from the Sub-Fund within a period of 5 years. Allianz China Future Technologies is aimed at investors with basic knowledge and/or experience of financial products. Prospective investors should be capable of bearing a financial loss and should not attach any importance to capital protection.

Other Provisions / Restrictions / Additional Information

- Shares of Share Class PT9 may only be acquired by Credit Suisse or its affiliates.
- The minimum subscription amount for the investment in Shares of the Share Class PT9 (after deduction of any Sales Charge) is USD 10 million or equivalent in other currencies. In certain cases, the Management Company has discretion to permit lower minimum investments.
- The Subscription Price of the Shares must be received by the Company in cleared funds within three Valuation Days after the calculation of the Subscription Price. The Redemption Price will be paid out within three Valuation Days after the calculation of the Redemption Price.

Allianz China Healthy Living

Investor Profile

Allianz China Healthy Living is aimed at investors who pursue the objective of general capital formation/asset optimisation and/or above-average participation in price changes. It may not be suitable for investors who wish to withdraw their capital from the Sub-Fund within a period of 5 years. Allianz China Healthy Living is aimed at investors with basic knowledge and/or experience of financial products. Prospective investors should be capable of bearing a financial loss and should not attach any importance to capital protection.

Other Provisions / Restrictions / Additional Information

- The Subscription Price of the Shares must be received by the Company in cleared funds within three Valuation Days after the calculation of the Subscription Price. The Redemption Price will be paid out within three Valuation Days after the calculation of the Redemption Price.

Allianz China Multi Income Plus

Investor Profile

Allianz China Multi Income Plus is aimed at investors who pursue the objective of general capital formation/asset optimisation and/or above-average participation in price changes. It may not be suitable for investors who wish to withdraw their capital from the Sub-Fund within a period of 4 years. Allianz China Multi Income Plus is aimed at investors with basic knowledge and/or experience of financial products. Prospective investors should be capable of bearing a financial loss and should not attach any importance to capital protection.

Other Provisions / Restrictions / Additional Information

- The Subscription Price of the Shares must be received by the Company in cleared funds within three Valuation Days after the calculation of the Subscription Price. The Redemption Price will be paid out within three Valuation Days after calculation the Redemption Price.

Allianz China Strategic Bond

Investor Profile

Allianz China Strategic Bond is aimed at investors who pursue the objective of general capital formation/asset optimisation. It may not be suitable for investors who wish to withdraw their capital from the Sub-Fund within a period of 4 years. Allianz China Strategic Bond is aimed at investors with basic knowledge and/or experience of financial products. Prospective investors should be capable of bearing a financial loss and should not attach any importance to capital protection.

Other Provisions / Restrictions / Additional Information

- The Subscription Price of the Shares must be received by the Company in cleared funds within five Valuation Days after the calculation of the Subscription Price, applicable for all Share Classes. The Redemption Price will be paid out within five Valuation Days after calculation the Redemption Price, applicable for all Share Classes.

Allianz China Thematica

Investor Profile

Allianz China Thematica is aimed at investors who pursue the objective of general capital appreciation/asset optimisation and/or above-average participation in price changes. It may not be suitable for investors who wish to withdraw their capital from the Sub-Fund within a period of 5 years. Allianz China Thematica is aimed at investors with basic knowledge and/or experience of financial products. Prospective investors should be capable of bearing a financial loss and should not attach any importance to capital protection.

Other Provisions / Restrictions / Additional Information

- The Subscription Price of the Shares must be received by the Company in cleared funds within three Valuation Days after the calculation of the Subscription Price. The Redemption Price will be paid out within two Valuation Days after calculation of the Redemption Price, except for Share Class whose Reference Currency is AUD, CZK, DKK, HKD, HUF, JPY, NZD, PLN, RMB, SGD or ZAR which will be paid out within three Valuation Days after calculation of the Redemption Price.

Allianz Clean Planet

Investor Profile

Allianz Clean Planet is aimed at investors who pursue the objective of general capital formation/asset optimisation and/or above-average participation in price changes. It may not be suitable for investors who wish to withdraw their capital from the Sub-Fund within a period of 5 years. Allianz Clean Planet is aimed at investors with basic knowledge and/or experience of financial products. Prospective investors should be capable of bearing a financial loss and should not attach any importance to capital protection.

Other Provisions / Restrictions / Additional Information

-

Allianz Climate Transition

Investor Profile

Allianz Climate Transition is aimed at investors who pursue the objective of general capital formation/asset optimisation and/or above-average participation in price changes. It may not be suitable for investors who wish to withdraw their capital from the Sub-Fund within a period of 5 years. Allianz Climate Transition is aimed at investors with basic knowledge and/or experience of financial products. Prospective investors should be capable of bearing a financial loss and should not attach any importance to capital protection.

Other Provisions / Restrictions / Additional Information

-

Allianz Convertible Bond

Investor Profile

Allianz Convertible Bond is aimed at investors who pursue the objective of general capital formation/asset optimisation. It may not be suitable for investors who wish to withdraw their capital from the Sub-Fund within a period of 4 years. Allianz Convertible Bond is aimed at investors with basic knowledge and/or experience of financial products. Prospective investors should be capable of bearing a financial loss and should not attach any importance to capital protection.

Other Provisions / Restrictions / Additional Information

-

Allianz Coupon Select Plus V

Investor Profile

Allianz Coupon Select Plus V is aimed at investors who pursue the objective of general capital formation/asset optimisation and/or above-average participation in price changes. It may not be suitable for investors who wish to withdraw their capital from the Sub-Fund within a period of 3 years. Allianz Coupon Select Plus V is aimed at investors with basic knowledge and/or experience of financial products. Prospective investors should be capable of bearing a financial loss and should not attach any importance to capital protection.

Other Provisions / Restrictions / Additional Information

- A placement fee of up to 2.00% of initial NAV at Sub-Fund's launch date for all types of share classes is levied on the Sub-Fund and paid out in a single instalment after two months of the fund launch. This Placement Fee is then amortized over a 4-year period of the Sub-Fund. The Management Company has discretion to levy a lower Placement Fee.
- An exit fee of up to 2.00% of initial NAV at Sub-Fund's launch date for all types of share classes will be applied two months after the Sub-Fund's launch date. The exit fee will remain in the Sub-Fund and is calculated as a fix amount per Share of a Share Class. The amount will be reduced by 0.25% of the initial NAV at launch date on a semi-annual basis.
- The Management Company intends to limit the subscription period such that the Sub-Fund or selected share classes will be closed for subscriptions two month after the launch of the Sub-Fund. This closure for subscriptions might not necessarily rely on market conditions and can be decided on a discretionary basis by the Management Company.
- The investment strategy of the Sub-Fund is similar to the investment strategy followed by other Sub-Funds of the Company. However, these Sub-Funds may differ from each other on several criteria such as, but not limited to, the initial subscription period, the launch date, the investment horizon or the applicable pricing. The balanced portfolio is constructed in such a way to offer attractive risk adjusted returns over the recommended holding period, namely the placement fee amortization period corresponding to the period during which exit fees are applicable.
- The Management Company has the intention – but is legally not obliged – to liquidate or merge the Sub-Fund into another UCITS or UCI after 4 to 9 years after the Sub-Fund's launch date.

Allianz Coupon Select Plus VI

Investor Profile

Allianz Coupon Select Plus VI is aimed at investors who pursue the objective of general capital formation/asset optimisation and/or above-average participation in price changes. It may not be suitable for investors who wish to withdraw their capital from the Sub-Fund within a period of 4 years. Allianz Coupon Select Plus VI is aimed at investors with basic knowledge and/or experience of financial products. Prospective investors should be capable of bearing a financial loss and should not attach any importance to capital protection.

Other Provisions / Restrictions / Additional Information

- A placement fee of up to 2.50% of initial NAV at Sub-Fund's launch date for all types of share classes is levied on the Sub-Fund and paid out in a single instalment after the end of the subscription period. This Placement Fee is then amortized over a 5-year period of the Sub-Fund. The Management Company has discretion to levy a lower Placement Fee.
- An exit fee up of up to 2.50% of initial NAV at Sub-Fund's launch date for all types of share classes will be applied after the end of the subscription period. The exit fee will remain in the Sub-Fund and is calculated as a fix amount per Share of a Share Class. The amount will be reduced by 0.25% of the initial NAV at launch date on a semi-annual basis.
- The Management Company intends to limit subscriptions such that the Sub-Fund or selected share classes will be closed for subscriptions after the end of a subscription period to be determined yet. This closure for subscriptions might not necessarily rely on market conditions and can be decided on a discretionary basis by the Management Company.
- The investment strategy of the Sub-Fund is similar to the investment strategy followed by other Sub-Funds of the Company. However, these Sub-Funds may differ from each other on several criteria such as, but not limited to, the initial subscription period, the launch date, the investment horizon or the applicable pricing. The balanced portfolio is constructed in such a way to offer attractive risk adjusted returns over the recommended holding period, namely the placement fee amortization period corresponding to the period during which exit fees are applicable.
- The Management Company has the intention – but is legally not obliged – to liquidate or merge the Sub-Fund into another UCITS or UCI after 5 to 9 years after the Sub-Fund's launch date.

Allianz Credit Opportunities

Investor Profile

Allianz Credit Opportunities is aimed at investors who pursue the objective of general capital formation/asset optimisation and/or above-average participation in price changes. It may not be suitable for investors who wish to withdraw their capital from the Sub-Fund within a period of 4 years. Allianz Credit Opportunities is aimed at investors with basic knowledge and/or experience of financial products. Prospective investors should be capable of bearing a financial loss and should not attach any importance to capital protection.

Other Provisions / Restrictions / Additional Information

-

Allianz Credit Opportunities Plus

Investor Profile

Allianz Credit Opportunities Plus is aimed at investors who pursue the objective of general capital formation/asset optimisation and/or above-average participation in price changes. It may not be suitable for investors who wish to withdraw their capital from the Sub-Fund within a period of 4 years. Allianz Credit Opportunities Plus is aimed at investors with basic knowledge and/or experience of financial products. Prospective investors should be capable of bearing a financial loss and should not attach any importance to capital protection.

Other Provisions / Restrictions / Additional Information

- Shares of Share Classes P24 and PT24 may only be acquired by DekaBank Deutsche Girozentrale (and its affiliates), Landesbank Baden-Württemberg (and its affiliates) and UniCredit (and its affiliates).

Allianz Cyber Security

Investor Profile

Allianz Cyber Security is aimed at investors who pursue the objective of general capital formation/asset optimisation and/or above-average participation in price changes. It may not be suitable for investors who wish to withdraw their capital from the Sub-Fund within a period of 5 years. Allianz Cyber Security is aimed at investors with basic knowledge and/or experience of financial products. Prospective investors should be capable of bearing a financial loss and should not attach any importance to capital protection.

Other Provisions / Restrictions / Additional Information

-

Allianz Dynamic Allocation Plus Equity

Investor Profile

Allianz Dynamic Allocation Plus Equity is aimed at investors who pursue the objective of general capital formation/asset optimisation and/or above-average participation in price changes. It may not be suitable for investors who wish to withdraw their capital from the Sub-Fund within a period of 5 years. Allianz Dynamic Allocation Plus Equity is aimed at investors with basic knowledge and/or experience of financial products. Prospective investors should be capable of bearing a financial loss and should not attach any importance to capital protection.

Other Provisions / Restrictions / Additional Information

-

Allianz Dynamic Asian High Yield Bond

Investor Profile

Allianz Dynamic Asian High Yield Bond is aimed at investors who pursue the objective of general capital formation/asset optimisation and/or above-average participation in price changes. It may not be suitable for investors who wish to withdraw their capital from the Sub-Fund within a period of 4 years. Allianz Dynamic Asian High Yield Bond is aimed at investors with basic knowledge and/or experience of financial products. Prospective investors should be capable of bearing a financial loss and should not attach any importance to capital protection.

Other Provisions / Restrictions / Additional Information

- The Subscription Price of the Shares must be received by the Company in cleared funds within three Valuation Days after the calculation of the Subscription Price, applicable for all Share Classes. The Redemption Price will be paid out within three Valuation Days after calculation the Redemption Price, applicable for all Share Classes.
- The minimum subscription amount for the investment in Shares in Share Classes P8 and PT8 (after deduction of any Sales Charge) is EUR 2.4 million or equivalent in other currencies. In certain cases, the Management Company has discretion to permit lower minimum investments.

Allianz Dynamic Commodities

Investor Profile

Allianz Dynamic Commodities is aimed at investors who pursue the objective of general capital formation/asset optimisation and/or above-average participation in price changes. It may not be suitable for investors who wish to withdraw their capital from the Sub-Fund within a period of 5 years. Allianz Dynamic Commodities is aimed at investors with basic knowledge and/or experience of financial products. Prospective investors should be capable of bearing a financial loss and should not attach any importance to capital protection.

Other Provisions / Restrictions / Additional Information

-

Allianz Dynamic Multi Asset Strategy SRI 15

Investor Profile

Allianz Dynamic Multi Asset Strategy SRI 15 is aimed at investors who pursue the objective of general capital formation/asset optimisation. It may not be suitable for investors who wish to withdraw their capital from the Sub-Fund within a period of 3 years. Allianz Dynamic Multi Asset Strategy SRI 15 is aimed at investors with basic knowledge and/or experience of financial products. Prospective investors should be capable of bearing a financial loss and should not attach any importance to capital protection.

Other Provisions / Restrictions / Additional Information

- Placement fee of up to 2.50% of Share Classes C6/CT6's and W6/WT6's initial Net Asset Value is levied at the launch date of Share Classes C6/CT6 and W6/WT6 and paid out in a single instalment within five months of the Share Classes C6/CT6's and W6/WT6's launch date. This Placement Fee is then amortized over a 5-year period of the Sub-Fund. The Management Company has discretion to levy a lower Placement Fee.
- An exit fee of up to 2.50% of Share Classes C6/CT6's and W6/WT6's initial Net Asset Value is levied at the launch of Share Classes C6/CT6 and W6/WT6. The exit fee will remain in the Share Classes C6/CT6 and W6/WT6 and is calculated as a fix amount per Share of Share Classes C6/CT6 and W6/WT6. The amount will be reduced by up to 0.25 % of the initial NAV at launch date on a semi-annual basis.
- Share Class Type C/CT may contain additional name "Allianz Goal Sports" which is placed prior to the Share Class type.
- Shares of Share Class CT2 (EUR) may only be acquired by Allianz Compañía de Seguros y Reaseguros, S.A. and its subsidiaries.
- The minimum subscription amount for the investment in Shares of the Share Class CT2 (EUR) (after deduction of any Sales Charge) is EUR 75,000. In certain cases, the Management Company has discretion to permit lower minimum investments.
- The minimum subscription amount for the investment in Shares of the Share Class AT2 (H2-CHF) (after deduction of any Sales Charge) is CHF 75,000. In certain cases, the Management Company has discretion to permit lower minimum investments.
- Shares of Share Classes I2 (EUR) and IT2 (EUR) may only be acquired by Allianz Lebensversicherungs AG or its subsidiaries.
- Share Class types W/WT may contain the additional name "ASAC FAPES" which is placed prior to the Share Class type.
- Shares of Share Classes ASAC FAPES WT7 (EUR) may only be acquired by Allianz France and its subsidiaries.

Allianz Dynamic Multi Asset Strategy SRI 50

Investor Profile

Allianz Dynamic Multi Asset Strategy SRI 50 is aimed at investors who pursue the objective of general capital formation/asset optimisation and/or above-average participation in price changes. It may not be suitable for investors who wish to withdraw their capital from the Sub-Fund within a period of 4 years. Allianz Dynamic Multi Asset Strategy SRI 50 is aimed at investors with basic knowledge and/or experience of financial products. Prospective investors should be capable of bearing a financial loss and should not attach any importance to capital protection.

Other Provisions / Restrictions / Additional Information

- Placement fee of up to 2.50% of Share Classes C6/CT6's and W6/WT6's initial Net Asset Value is levied at the launch date of Share Classes C6/CT6 and W6/WT6 and paid out in a single instalment within five months of the Share Classes C6/CT6's and W6/WT6's launch date. This Placement Fee is then amortized over a 5-year period of the Sub-Fund. The Management Company has discretion to levy a lower Placement Fee.
- An exit fee of up to 2.50% of Share Classes C6/CT6's and W6/WT6's initial Net Asset Value is levied at the launch of Share Classes C6/CT6 and W6/WT6. The exit fee will remain in the Share Classes C6/CT6 and W6/WT6 and is calculated as a fix amount per Share of Share Classes C6/CT6 and W6/WT6. The amount will be reduced by up to 0.25 % of the initial NAV at launch date on a semi-annual basis.
- Shares of Share Class CT2 (EUR) may only be acquired by Allianz Compañía de Seguros y Reaseguros, S.A. and its subsidiaries.
- The minimum subscription amount for the investment in Shares of the Share Class CT2 (EUR) (after deduction of any Sales Charge) is EUR 75,000. In certain cases, the Management Company has discretion to permit lower minimum investments.
- The minimum subscription amount for the investment in Shares of the Share Class AT2 (H2-CHF) (after deduction of any Sales Charge) is CHF 75,000. In certain cases, the Management Company has discretion to permit lower minimum investments.
- The minimum subscription amount for the investment in Shares of the Share Class P9 (EUR) (after deduction of any Sales Charge) is EUR 50 million. In certain cases, the Management Company has discretion to permit lower minimum investments.
- Shares of Share Classes I2 (EUR) and IT2 (EUR) may only be acquired by Allianz Lebensversicherungs AG or its subsidiaries.

Allianz Dynamic Multi Asset Strategy SRI 75

Investor Profile

Allianz Dynamic Multi Asset Strategy SRI 75 is aimed at investors who pursue the objective of general capital formation/asset optimisation and/or above-average participation in price changes. It may not be suitable for investors who wish to withdraw their capital from the Sub-Fund within a period of 4 years. Allianz Dynamic Multi Asset Strategy SRI 75 is aimed at investors with basic knowledge and/or experience of financial products. Prospective investors should be capable of bearing a financial loss and should not attach any importance to capital protection.

Other Provisions / Restrictions / Additional Information

- Placement fee of up to 3.00% of Share Classes C6/CT6's and W6/WT6's initial Net Asset Value is levied at the launch date of Share Classes C6/CT6 and W6/WT6 and paid out in a single instalment within five months of the Share Classes C6/CT6's and W6/WT6's launch date. This Placement Fee is then amortized over a 5-year period of the Sub-Fund. The Management Company has discretion to levy a lower Placement Fee.
- An exit fee of up to 3.00% of Share Classes C6/CT6's and W6/WT6's initial Net Asset Value is levied at the launch of Share Classes C6/CT6 and W6/WT6. The exit fee will remain in the Share Classes C6/CT6 and W6/WT6 and is calculated as a fixed amount per Share of Share Classes C6/CT6 and W6/WT6. The amount will be reduced by up to 0.30% of the initial NAV at launch date on a semi-annual basis.
- Shares of Share Class CT2 (EUR) may only be acquired by Allianz Compañía de Seguros y Reaseguros, S.A. and its subsidiaries.
- The minimum subscription amount for the investment in Shares of the Share Class CT2 (EUR) (after deduction of any Sales Charge) is EUR 75,000. In certain cases, the Management Company has discretion to permit lower minimum investments.
- The minimum subscription amount for the investment in Shares of the Share Class AT2 (H2-CHF) (after deduction of any Sales Charge) is CHF 75,000. In certain cases, the Management Company has discretion to permit lower minimum investments.
- The minimum subscription amount for the investment in Shares of the Share Class P9 (EUR) (after deduction of any Sales Charge) is EUR 50 million. In certain cases, the Management Company has discretion to permit lower minimum investments.
- Shares of Share Classes I2 (EUR) and IT2 (EUR) may only be acquired by Allianz Lebensversicherungs AG or its subsidiaries.

Allianz Emerging Asia Equity

Investor Profile

Allianz Emerging Asia Equity is aimed at investors who pursue the objective of general capital formation/asset optimisation and/or above-average participation in price changes. It may not be suitable for investors who wish to withdraw their capital from the Sub-Fund within a period of 5 years. Allianz Emerging Asia Equity is aimed at investors with basic knowledge and/or experience of financial products. Prospective investors should be capable of bearing a financial loss and should not attach any importance to capital protection.

Other Provisions / Restrictions / Additional Information

- The Subscription Price of the Shares must be received by the Company in cleared funds within three Valuation Days after the calculation of the Subscription Price. The Redemption Price will be paid out within three Valuation Days after calculation the Redemption Price.

Allianz Emerging Europe Equity

Investor Profile

Allianz Emerging Europe Equity is aimed at investors who pursue the objective of general capital formation/asset optimisation and/or above-average participation in price changes. It may not be suitable for investors who wish to withdraw their capital from the Sub-Fund within a period of 5 years. Allianz Emerging Europe Equity is aimed at investors with basic knowledge and/or experience of financial products. Prospective investors should be capable of bearing a financial loss and should not attach any importance to capital protection.

Other Provisions / Restrictions / Additional Information

-

Allianz Emerging Markets Equity

Investor Profile

Allianz Emerging Markets Equity is aimed at investors who pursue the objective of general capital formation/asset optimisation and/or above-average participation in price changes. It may not be suitable for investors who wish to withdraw their capital from the Sub-Fund within a period of 5 years. Allianz Emerging Markets Equity is aimed at investors with basic knowledge and/or experience of financial products. Prospective investors should be capable of bearing a financial loss and should not attach any importance to capital protection.

Other Provisions / Restrictions / Additional Information

- Shares of Share Classes IT8 (EUR) and IT8 (H-EUR) may only be acquired for clients domiciled in Italy which have signed a discretionary investment management agreement with the Management Company.
- Shares of Share Class P14 and PT14 may only be acquired with the consent of the Management Company.
- No trail commissions may be paid to any sales partners in relation to Share Classes P14 and PT14.

Allianz Emerging Markets Equity Opportunities

Investor Profile

Allianz Emerging Markets Equity Opportunities is aimed at investors who pursue the objective of general capital formation/asset optimisation and/or above-average participation in price changes. It may not be suitable for investors who wish to withdraw their capital from the Sub-Fund within a period of 5 years. Allianz Emerging Markets Equity Opportunities is aimed at investors with basic knowledge and/or experience of financial products. Prospective investors should be capable of bearing a financial loss and should not attach any importance to capital protection.

Other Provisions / Restrictions / Additional Information

- The minimum subscription amount for the investment in Shares of the Share Class WT2 (EUR) (after deduction of any Sales Charge) is EUR 10 million. In certain cases, the Management Company has discretion to permit lower minimum investments.

Allianz Emerging Markets Equity SRI

Investor Profile

Allianz Emerging Markets Equity SRI is aimed at investors who pursue the objective of general capital formation/asset optimisation and/or above-average participation in price changes. It may not be suitable for investors who wish to withdraw their capital from the Sub-Fund within a period of 5 years. Allianz Emerging Markets Equity SRI is aimed at investors with basic knowledge and/or experience of financial products. Prospective investors should be capable of bearing a financial loss and should not attach any importance to capital protection.

Other Provisions / Restrictions / Additional Information

- Shares of Share Classes IT8 (EUR) and IT8 (H-EUR) may only be acquired for clients domiciled in Italy which have signed a discretionary investment management agreement with the Management Company.
- Shares of Share Class P14 and PT14 may only be acquired with the consent of the Management Company.
- No trail commissions may be paid to any sales partners in relation to Share Classes P14 and PT14.

Allianz Emerging Markets Multi Asset Income

Investor Profile

Allianz Emerging Markets Multi Asset Income is aimed at investors who pursue the objective of general capital formation/asset optimisation and/or above-average participation in price changes. It may not be suitable for investors who wish to withdraw their capital from the Sub-Fund within a period of 4 years. Allianz Emerging Markets Multi Asset Income is aimed at investors with basic knowledge and/or experience of financial products. Prospective investors should be capable of bearing a financial loss and should not attach any importance to capital protection.

Other Provisions / Restrictions / Additional Information

- The Subscription Price of the Shares must be received by the Company in cleared funds within three Valuation Days after the calculation of the Subscription Price. The Redemption Price will be paid out within three Valuation Days after calculation the Redemption Price.

Allianz Emerging Markets Select Bond

Investor Profile

Allianz Emerging Markets Select Bond is aimed at investors who pursue the objective of general capital formation/asset optimisation. It may not be suitable for investors who wish to withdraw their capital from the Sub-Fund within a period of 4 years. Allianz Emerging Markets Select Bond is aimed at investors with basic knowledge and/or experience of financial products. Prospective investors should be capable of bearing a financial loss and should not attach any importance to capital protection.

Other Provisions / Restrictions / Additional Information

-

Allianz Emerging Markets Short Duration Bond

Investor Profile

Allianz Emerging Markets Short Duration Bond is aimed at investors who pursue the objective of general capital formation/asset optimisation. It may not be suitable for investors who wish to withdraw their capital from the Sub-Fund within a period of 3 years. Allianz Emerging Markets Short Duration Bond is aimed at investors with basic knowledge and/or experience of financial products. Prospective investors should be capable of bearing a financial loss and should not attach any importance to capital protection.

Other Provisions / Restrictions / Additional Information

- The minimum subscription amount for the investment in Shares of the Share Class W2 (H2-EUR) (after deduction of any Sales Charge) is EUR 30 million. In certain cases, the Management Company has discretion to permit lower minimum investments.
- Shares of Share Classes IT8 (H-EUR) may only be acquired for clients domiciled in Italy which have signed a discretionary investment management agreement with the Management Company.

Allianz Emerging Markets Sovereign Bond

Investor Profile

Allianz Emerging Markets Sovereign Bond is aimed at investors who pursue the objective of general capital formation/asset optimisation. It may not be suitable for investors who wish to withdraw their capital from the Sub-Fund within a period of 4 years. Allianz Emerging Markets Sovereign Bond is aimed at investors with basic knowledge and/or experience of financial products. Prospective investors should be capable of bearing a financial loss and should not attach any importance to capital protection.

Other Provisions / Restrictions / Additional Information

- Shares of Share Classes IT8 (H2-EUR) may only be acquired for clients domiciled in Italy which have signed a discretionary investment management agreement with the Management Company.
- Shares of Share Classes W91/WT91 may only be acquired by investment vehicles managed by legal entities of Allianz Global Investors group.

Allianz Emerging Markets SRI Bond

Investor Profile

Allianz Emerging Markets SRI Bond is aimed at investors who pursue the objective of general capital formation/asset optimisation. It may not be suitable for investors who wish to withdraw their capital from the Sub-Fund within a period of 4 years. Allianz Emerging Markets SRI Bond is aimed at investors with basic knowledge and/or experience of financial products. Prospective investors should be capable of bearing a financial loss and should not attach any importance to capital protection.

Other Provisions / Restrictions / Additional Information

-

Allianz Emerging Markets SRI Corporate Bond

Investor Profile

Allianz Emerging Markets SRI Corporate Bond is aimed at investors who pursue the objective of general capital formation/asset optimisation. It may not be suitable for investors who wish to withdraw their capital from the Sub-Fund within a period of 4 years. Allianz Emerging Markets SRI Corporate Bond is aimed at investors with basic knowledge and/or experience of financial products. Prospective investors should be capable of bearing a financial loss and should not attach any importance to capital protection.

Other Provisions / Restrictions / Additional Information

- The minimum subscription amount for the investment in Shares of Share Class W26 (H2-EUR) is EUR 50 million. In certain cases, the Management Company has discretion to permit lower minimum investments.

Allianz Enhanced All China Equity

Investor Profile

Allianz Enhanced All China Equity is aimed at investors who pursue the objective of general capital formation/asset optimisation and/or above-average participation in price changes. It may not be suitable for investors who wish to withdraw their capital from the Sub-Fund within a period of 5 years. Allianz Enhanced All China Equity is aimed at investors with basic knowledge and/or experience of financial products. Prospective investors should be capable of bearing a financial loss and should not attach any importance to capital protection.

Other Provisions / Restrictions / Additional Information

- The Subscription Price of the Shares must be received by the Company in cleared funds within three Valuation Days after the calculation of the Subscription Price. The Redemption Price will be paid out within three Valuation Days after calculation the Redemption Price.

Allianz Enhanced Short Term Euro

Investor Profile

Allianz Enhanced Short Term Euro is aimed at investors who pursue the objective of general capital formation/asset optimisation. It may not be suitable for investors who wish to withdraw their capital from the Sub-Fund within a period of 1 year. Allianz Enhanced Short Term Euro is aimed at investors with basic knowledge and/or experience of financial products. Prospective investors should be capable of bearing a financial loss and should not attach any importance to capital protection.

Other Provisions / Restrictions / Additional Information

- Share Class types A/AT, I/IT, P/PT, R/RT and W/WT may contain the additional name "Euro Basis Plus" which is placed prior to the Share Class type.
- Share Class types A/AT may contain the additional name "Euro Basis Plus P+G" which is placed prior to the Share Class type.
- Share Class types A/AT may contain the additional name "CB Kurzfristanlage" which is placed prior to the Share Class type.
- The minimum subscription amount for the investment in Shares of Share Classes CB Kurzfristanlage A/AT (EUR) (after deduction of any Sales Charge) is EUR 100,000 or equivalent in other currencies. In certain cases, the Management Company has discretion to permit lower minimum investments.
- Shares of Share Classes CB Kurzfristanlage A/AT (EUR) may only be acquired by Commerzbank AG or its affiliates.
- Share Class types P/PT may contain the additional name "Euro Basis Plus WM" which is placed prior to the Share Class type.
- Shares of Share Classes P3 and PT3 may only be acquired by DeGroofPetercam.
- The minimum subscription amount for the investment in Shares of Share Classes P3 and PT3 (after deduction of any Sales Charge) is EUR 50 million or equivalent in other currencies. In certain cases, the Management Company has discretion to permit lower minimum investments.

Allianz Euro Balanced

Investor Profile

Allianz Euro Balanced is aimed at investors who pursue the objective of general capital formation/asset optimisation and/or above-average participation in price changes. It may not be suitable for investors who wish to withdraw their capital from the Sub-Fund within a period of 4 years. Allianz Euro Balanced is aimed at investors with basic knowledge and/or experience of financial products. Prospective investors should be capable of bearing a financial loss and should not attach any importance to capital protection.

Other Provisions / Restrictions / Additional Information

- The minimum subscription amount for the investment in Shares of the Share Class I2 (EUR) and IT2 (EUR) (after deduction of any Sales Charge) is EUR 500,000. In certain cases, the Management Company has discretion to permit lower minimum investments.

- Shares of Share Classes I4 (EUR) and IT4 (EUR) may only be acquired by Allianz Nederland Levensverzekering and/or Allianz Benelux.

Allianz Euro Bond

Investor Profile

Allianz Euro Bond is aimed at investors who prioritise safety and/or pursue the objective of general capital formation/asset optimisation. It may not be suitable for investors who wish to withdraw their capital from the Sub-Fund within a period of 3 years. Allianz Euro Bond is aimed at investors with basic knowledge and/or experience of financial products. Prospective investors should be capable of bearing a financial loss and should not attach any importance to capital protection.

Other Provisions / Restrictions / Additional Information

- Shares of Share Classes AT2 (EUR) may only be acquired by Allianz France and its subsidiaries
- Shares of Share Classes C2/CT2 (EUR) may only be acquired by Allianz Italy and its subsidiaries

Allianz Euro Bond Short Term 1-3 Plus

Investor Profile

Allianz Euro Bond Short Term 1-3 Plus is aimed at investors who pursue the objective of general capital formation/asset optimisation. It may not be suitable for investors who wish to withdraw their capital from the Sub-Fund within a period of 2 years. Allianz Euro Bond Short Term 1-3 Plus is aimed at investors with basic knowledge and/or experience of financial products. Prospective investors should be capable of bearing a financial loss and should not attach any importance to capital protection.

Other Provisions / Restrictions / Additional Information

-

Allianz Euro Credit SRI

Investor Profile

Allianz Euro Credit SRI is aimed at investors who pursue the objective of general capital formation/asset optimisation. It may not be suitable for investors who wish to withdraw their capital from the Sub-Fund within a period of 3 years. Allianz Euro Credit SRI is aimed at investors with basic knowledge and/or experience of financial products. Prospective investors should be capable of bearing a financial loss and should not attach any importance to capital protection.

Other Provisions / Restrictions / Additional Information

- Shares of Share Class R2 (EUR) may only be acquired by BNP Paribas for discretionary portfolio management solely.
- The minimum subscription amount for the investment in Shares of Share Class R2 (EUR) is EUR 10 million. In certain cases, the Management Company has discretion to permit lower minimum investments.
- Shares of Share Classes W33 (EUR) and WT33 (EUR) may only be acquired by BNP Paribas Fortis and its subsidiaries.
- The minimum subscription amount for the investment in Shares of Share Classes W33 and WT33 (after deduction of any Sales Charge) is EUR 100 million. In certain cases, the Management Company has discretion to permit lower minimum investments.

Allianz Euro Government Bond

Investor Profile

Allianz Euro Government Bond aimed at investors who prioritise safety and/or pursue the objective of general capital formation/asset optimisation. It may not be suitable for investors who wish to withdraw their capital from the Sub-Fund within a period of 3 years. Allianz Euro Government Bond is aimed at investors with basic knowledge and/or experience of financial products. Prospective investors should be capable of bearing a financial loss and should not attach any importance to capital protection.

Other Provisions / Restrictions / Additional Information

- The minimum subscription amount for the investment in Shares of the Share Class I2 (EUR) and IT2 (EUR) (after deduction of any Sales Charge) is EUR 500,000. In certain cases, the Management Company has discretion to permit lower minimum investments.
- Shares of Share Classes I4 (EUR) and IT4 (EUR) may only be acquired by Allianz Nederland Levensverzekering and/or Allianz Benelux.

Allianz Euro High Yield Bond

Investor Profile

Allianz Euro High Yield Bond is aimed at investors who pursue the objective of general capital formation/asset optimisation. It may not be suitable for investors who wish to withdraw their capital from the Sub-Fund within a period of 4 years. Allianz Euro High Yield Bond is aimed at investors with basic knowledge and/or experience of financial products. Prospective investors should be capable of bearing a financial loss and should not attach any importance to capital protection.

Other Provisions / Restrictions / Additional Information

- Shares of Share Classes IT8 (H-EUR) may only be acquired for clients domiciled in Italy which have signed a discretionary investment management agreement with the Management Company.

Allianz Euro High Yield Defensive

Investor Profile

Allianz Euro High Yield Defensive is aimed at investors who pursue the objective of general capital formation/asset optimisation. It may not be suitable for investors who wish to withdraw their capital from the Sub-Fund within a period of 4 years. Allianz Euro High Yield Defensive is aimed at investors with basic knowledge and/or experience of financial products. Prospective investors should be capable of bearing a financial loss and should not attach any importance to capital protection.

Other Provisions / Restrictions / Additional Information

-

Allianz Euro Inflation-linked Bond

Investor Profile

Allianz Euro Inflation-linked Bond is aimed at investors who pursue the objective of general capital formation/asset optimisation. It may not be suitable for investors who wish to withdraw their capital from the Sub-Fund within a period of 3 years. Allianz Euro Inflation-linked Bond is aimed at investors with basic knowledge and/or experience of financial products. Prospective investors should be capable of bearing a financial loss and should not attach any importance to capital protection.

Other Provisions / Restrictions / Additional Information

- Shares of Share Class IT8 (EUR) may only be acquired for clients domiciled in Italy which have signed a discretionary investment management agreement with the Management Company.

Allianz Euroland Equity Growth

Investor Profile

Allianz Euroland Equity Growth is aimed at investors who pursue the objective of general capital formation/asset optimisation and/or above-average participation in price changes. It may not be suitable for investors who wish to withdraw their capital from the Sub-Fund within a period of 5 years. Allianz Euroland Equity Growth is aimed at investors with basic knowledge and/or experience of financial products. Prospective investors should be capable of bearing a financial loss and should not attach any importance to capital protection.

Other Provisions / Restrictions / Additional Information

-

Allianz Europe Equity Growth

Investor Profile

Allianz Europe Equity Growth is aimed at investors who pursue the objective of general capital formation/asset optimisation and/or above-average participation in price changes. It may not be suitable for investors who wish to withdraw their capital from the Sub-Fund within a period of 5 years. Allianz Europe Equity Growth is aimed at investors with basic knowledge and/or experience of financial products. Prospective investors should be capable of bearing a financial loss and should not attach any importance to capital protection.

Other Provisions / Restrictions / Additional Information

-

Allianz Europe Equity Growth Select

Investor Profile

Allianz Europe Equity Growth Select is aimed at investors who pursue the objective of general capital formation/asset optimisation and/or above-average participation in price changes. It may not be suitable for investors who wish to withdraw their capital from the Sub-Fund within a period of 5 years. Allianz Europe Equity Growth Select is aimed at investors with basic knowledge and/or experience of financial products. Prospective investors should be capable of bearing a financial loss and should not attach any importance to capital protection.

Other Provisions / Restrictions / Additional Information

- Shares of Share Classes IT8 (H-EUR) may only be acquired for clients domiciled in Italy which have signed a discretionary investment management agreement with the Management Company.
- For the share class W6 (EUR) the Company targets to distribute an amount which will be determined each year individually. It is envisaged that the net performance of the share class of the previous fiscal year will be fully or partially distributed even if such distribution would require to distribute unrealized capital gains and/or capital. The amount will in no case exceed the amount distributable by applying the general distribution policy for Distribution Shares.
- Shares of Share Classes W63 and WT63 may only be acquired by Navigera AB or its affiliates.
- Share Class type A/AT and W/WT may contain the additional name "GAIPARE CROISSANCE EUROPE" which is placed prior to the Share Class type.
- Shares of Share Class GAIPARE CROISSANCE EUROPE AT and GAIPARE CROISSANCE EUROPE WT may only be acquired by Allianz France and its subsidiaries.

Allianz Europe Equity powered by Artificial Intelligence

Investor Profile

Allianz Europe Equity powered by Artificial Intelligence is aimed at investors who pursue the objective of general capital formation/asset optimisation and/or above-average participation in price changes. It may not be suitable for investors who wish to withdraw their capital from the Sub-Fund within a period of 5 years. Allianz Europe Equity powered by Artificial Intelligence is aimed at investors with basic knowledge and/or experience of financial products. Prospective investors should be capable of bearing a financial loss and should not attach any importance to capital protection.

Other Provisions / Restrictions / Additional Information

-

Allianz Europe Equity SRI

Investor Profile

Allianz Europe Equity SRI is aimed at investors who pursue the objective of general capital formation/asset optimisation and/or above-average participation in price changes. It may not be suitable for investors who wish to withdraw their capital from the Sub-Fund within a period of 5 years. Allianz Europe Equity SRI is aimed at investors with basic knowledge and/or experience of financial products. Prospective investors should be capable of bearing a financial loss and should not attach any importance to capital protection.

Other Provisions / Restrictions / Additional Information

- Shares of Share Class CT2 (EUR) may only be acquired by Allianz France S.A. and its subsidiaries.
- Shares of Share Classes IT8 (H-EUR) may only be acquired for clients domiciled in Italy which have signed a discretionary investment management agreement with the Management Company.
- Shares of Share Classes R2 (EUR) and RT2 (EUR) may only be acquired by BNP Paribas for discretionary portfolio management solely.
- The minimum subscription amount for the investment in Shares of Share Classes R2 (EUR) and RT2 (EUR) is EUR 10 million. In certain cases, the Management Company has discretion to permit lower minimum investments.

Allianz Europe Equity Value

Investor Profile

Allianz Europe Equity Value is aimed at investors who pursue the objective of general capital formation/asset optimisation and/or above-average participation in price changes. It may not be suitable for investors who wish to withdraw their capital from the Sub-Fund within a period of 5 years. Allianz Europe Equity Value is aimed at investors with basic knowledge and/or experience of financial products. Prospective investors should be capable of bearing a financial loss and should not attach any importance to capital protection.

Other Provisions / Restrictions / Additional Information

-

Allianz Europe Income and Growth

Investor Profile

Allianz Europe Income and Growth is aimed at investors who pursue the objective of general capital formation/asset optimisation and/or above-average participation in price changes. It may not be suitable for investors who wish to withdraw their capital from the Sub-Fund within a period of 4 years. Allianz Europe Income and Growth is aimed at investors with basic knowledge and/or experience of financial products. Prospective investors should be capable of bearing a financial loss and should not attach any importance to capital protection.

Other Provisions / Restrictions / Additional Information

-

Allianz Europe Mid Cap Equity

Investor Profile

Allianz Europe Mid Cap Equity is aimed at investors who pursue the objective of general capital formation/asset optimisation and/or above-average participation in price changes. It may not be suitable for investors who wish to withdraw their capital from the Sub-Fund within a period of 5 years. Allianz Europe Mid Cap Equity is aimed at investors with basic knowledge and/or experience of financial products. Prospective investors should be capable of bearing a financial loss and should not attach any importance to capital protection.

Other Provisions / Restrictions / Additional Information

-

Allianz Europe Small and Micro Cap Equity

Investor Profile

Allianz Europe Small and Micro Cap Equity is aimed at investors who pursue the objective of general capital formation/asset optimisation and/or above-average participation in price changes. It may not be suitable for investors who wish to withdraw their capital from the Sub-Fund within a period of 5 years. Allianz Europe Small and Micro Cap Equity is aimed at investors with basic knowledge and/or experience of financial products. Prospective investors should be capable of bearing a financial loss and should not attach any importance to capital protection.

Other Provisions / Restrictions / Additional Information

- Share Class type A/AT may contain the additional name "Allianz Actions Europe PME-ETI" which is placed prior to the Share Class type.
- Shares of Share Class Allianz Actions Europe PME-ETI AT (EUR) may only be acquired by Allianz France and its subsidiaries.

Allianz Europe Small Cap Equity

Investor Profile

Allianz Europe Small Cap Equity is aimed at investors who pursue the objective of general capital formation/asset optimisation and/or above-average participation in price changes. It may not be suitable for investors who wish to withdraw their capital from the Sub-Fund within a period of 5 years. Allianz Europe Small Cap Equity is aimed at investors with basic knowledge and/or experience of financial products. Prospective investors should be capable of bearing a financial loss and should not attach any importance to capital protection.

Other Provisions / Restrictions / Additional Information

-

Allianz European Bond RC

Investor Profile

Allianz European Bond RC is aimed at investors who pursue the objective of general capital formation/ asset optimisation and/or above-average participation in price changes. It may not be suitable for investors who wish to withdraw their capital from the Sub-Fund within a period of 2 years. Allianz European Bond RC is aimed at investors with advanced knowledge and/ or experience of financial products. Prospective investors should be capable of bearing financial loss and should not attach any importance to capital protection.

Other Provisions / Restrictions / Additional Information

- Shares of Share Classes W5 and WT5 may only be acquired by Allianz SE and its subsidiaries.
- The minimum subscription amount for the investment in Shares of the Share Class W5 and WT5 (after deduction of any Sales Charge) is EUR 500 million. In certain cases, the Management Company has discretion to permit lower minimum investments.

Allianz European Equity Dividend

Investor Profile

Allianz European Equity Dividend is aimed at investors who pursue the objective of general capital formation/asset optimisation and/or above-average participation in price changes. It may not be suitable for investors who wish to withdraw their capital from the Sub-Fund within a period of 5 years. Allianz European Equity Dividend is aimed at investors with basic knowledge and/or experience of financial products. Prospective investors should be capable of bearing a financial loss and should not attach any importance to capital protection.

Other Provisions / Restrictions / Additional Information

- Share Class type A may contain the additional name "Aktienzins" which is placed prior to the Share Class type.
- Shares of Share Class W7 (EUR) may only be acquired by Allianz SE and its subsidiaries.
- The minimum subscription amount for the investment in Shares of Share Classes W7 (EUR) (after deduction of any Sales Charge) is EUR 50 million. In certain cases, the Management Company has discretion to permit lower minimum investments.
- Distributions of Shares of Share Class W7 (EUR) will be made within 4 months after fiscal year end.
- Shares of Share Class W8 may only be acquired by Allianz SE and its subsidiaries.
- The minimum subscription amount for the investment in Shares of Share Classes W8 (after deduction of any Sales Charge) is EUR 50 million. In certain cases, the Management Company has discretion to permit lower minimum investments.

Allianz Fixed Income Macro

Investor Profile

Allianz Fixed Income Macro is aimed at investors who pursue the objective of general capital formation/asset optimisation. It may not be suitable for investors who wish to withdraw their capital from the Sub-Fund within a period of 4 years. Allianz Fixed Income Macro is aimed at investors with advanced knowledge and/or experience of financial products. Prospective investors should be capable of bearing a financial loss and should not attach any importance to capital protection.

Other Provisions / Restrictions / Additional Information

- The minimum subscription amount for the investment in Shares in Share Classes P8 and PT8 (after deduction of any Sales Charge) is EUR 100,000 or equivalent in other currencies. In certain cases, the Management Company has discretion to permit lower minimum investments.
- The minimum subscription amount for the investment in Shares in Share Classes R2 and RT2 (after deduction of any Sales Charge) is EUR 10,000 or equivalent in other currencies. In certain cases, the Management Company has discretion to permit lower minimum investments.

Allianz Flexi Asia Bond

Investor Profile

Allianz Flexi Asia Bond is aimed at investors who pursue the objective of general capital formation/asset optimisation. It may not be suitable for investors who wish to withdraw their capital from the Sub-Fund within a period of 4 years. Allianz Flexi Asia Bond is aimed at investors with basic knowledge and/or experience of financial products. Prospective investors should be capable of bearing a financial loss and should not attach any importance to capital protection.

Other Provisions / Restrictions / Additional Information

- The minimum subscription amount for the investment in Shares in Share Classes P8 and PT8 (after deduction of any Sales Charge) is EUR 2.4 million or equivalent in other currencies. In certain cases, the Management Company has discretion to permit lower minimum investments.

Allianz Floating Rate Notes Plus

Investor Profile

Allianz Floating Rate Notes Plus is aimed at investors who prioritise safety and/or pursue the objective of general capital formation/asset optimisation. It may not be suitable for investors who wish to withdraw their capital from the Sub-Fund within a period of 1 year. Allianz Floating Rate Notes Plus is aimed at investors with basic knowledge and/or experience of financial products. Prospective investors should be capable of bearing a financial loss and should not attach any importance to capital protection.

Other Provisions / Restrictions / Additional Information

- The Subscription Price of the Shares must be received by the Company in cleared funds within one Valuation Day after the calculation of the Subscription Price, applicable for all Share Classes denominated in EUR and USD. The Redemption Price will be paid out within one Valuation Day after calculation the Redemption Price, applicable for all Share Classes denominated in EUR and USD.
- The Share Class types A, I and P may contain the additional name "VarioZins" which is placed prior to the Share Class type.
- The minimum subscription amount for the investment in Shares of the Share Classes P (EUR) and VarioZins P (EUR) (after deduction of any Sales Charge) is EUR 1 million. In certain cases, the Management Company has discretion to permit lower minimum investments.
- The minimum subscription amount for the investment in Shares of the Share Class AT2 (EUR) (after deduction of any Sales Charge) is EUR 950,000. In certain cases, the Management Company has discretion to permit lower minimum investments.
- The minimum subscription amount for the investment in Shares of the Share Classes I2 (EUR) and VarioZins I2 (EUR) (after deduction of any Sales Charge) is EUR 10 million. In certain cases, the Management Company has discretion to permit lower minimum investments.
- The minimum subscription amount for the investment in Shares of the Share Class I3 (EUR) (after deduction of any Sales Charge) is EUR 1 million. In certain cases, the Management Company has discretion to permit lower minimum investments.
- The minimum subscription amount for the investment in Shares of the Share Class VarioZins P (H2-USD) (after deduction of any Sales Charge) is USD 1 million. In certain cases, the Management Company has discretion to permit lower minimum investments.

Allianz Food Security

Investor Profile

Allianz Food Security is aimed at investors who pursue the objective of general capital formation/asset optimisation and/or above-average participation in price changes. It may not be suitable for investors who wish to withdraw their capital from the Sub-Fund within a period of 5 years. Allianz Food Security is aimed at investors with basic knowledge and/or experience of financial products. Prospective investors should be capable of bearing a financial loss and should not attach any importance to capital protection.

Other Provisions / Restrictions / Additional Information

-

Allianz GEM Equity High Dividend

Investor Profile

Allianz GEM Equity High Dividend is aimed at investors who pursue the objective of general capital formation/asset optimisation and/or above-average participation in price changes. It may not be suitable for investors who wish to withdraw their capital from the Sub-Fund within a period of 5 years. Allianz GEM Equity High Dividend is aimed at investors with basic knowledge and/or experience of financial products. Prospective investors should be capable of bearing a financial loss and should not attach any importance to capital protection.

Other Provisions / Restrictions / Additional Information

-

Allianz German Equity

Investor Profile

Allianz German Equity is aimed at investors who pursue the objective of general capital formation/asset optimisation and/or above-average participation in price changes. It may not be suitable for investors who wish to withdraw their capital from the Sub-Fund within a period of 5 years. Allianz German Equity is aimed at investors with basic knowledge and/or experience of financial products. Prospective investors should be capable of bearing a financial loss and should not attach any importance to capital protection.

Other Provisions / Restrictions / Additional Information

-

Allianz German Small and Micro Cap

Investor Profile

Allianz German Small and Micro Cap is aimed at investors who pursue the objective of general capital formation/asset optimisation and/or above-average participation in price changes. It may not be suitable for investors who wish to withdraw their capital from the Sub-Fund within a period of 5 years. Allianz German Small and Micro Cap is aimed at investors with basic knowledge and/or experience of financial products. Prospective investors should be capable of bearing a financial loss and should not attach any importance to capital protection.

Other Provisions / Restrictions / Additional Information

-

Allianz Global Aggregate Bond

Investor Profile

Allianz Global Aggregate Bond is aimed at investors who pursue the objective of general capital formation/asset optimisation and/or above-average participation in price changes. It may not be suitable for investors who wish to withdraw their capital from the Sub-Fund within a period of 4 years. Allianz Global Aggregate Bond is aimed at investors with basic knowledge and/or experience of financial products. Prospective investors should be capable of bearing a financial loss and should not attach any importance to capital protection.

Other Provisions / Restrictions / Additional Information

- With regard to Share Classes where "H4" appears before the Reference Currency the respective benchmark is BLOOMBERG Global Aggregate Total Return.

Allianz Global Artificial Intelligence

Investor Profile

Allianz Global Artificial Intelligence is aimed at investors who pursue the objective of general capital formation/asset optimisation and/or above-average participation in price changes. It may not be suitable for investors who wish to withdraw their capital from the Sub-Fund within a period of 5 years. Allianz Global Artificial Intelligence is aimed at investors with basic knowledge and/or experience of financial products. Prospective investors should be capable of bearing a financial loss and should not attach any importance to capital protection.

Other Provisions / Restrictions / Additional Information

- Shares of Share Class IT4 (EUR) may only be acquired by Allianz SE and its subsidiaries.

Allianz Global Capital Plus

Investor Profile

Allianz Global Capital Plus is aimed at investors who pursue the objective of general capital formation/asset optimisation. It may not be suitable for investors who wish to withdraw their capital from the Sub-Fund within a period of 3 years. Allianz Global Capital Plus is aimed at investors with basic knowledge and/or experience of financial products. Prospective investors should be capable of bearing a financial loss and should not attach any importance to capital protection.

Other Provisions / Restrictions / Additional Information

- A placement fee of up to 2.50% of initial NAV at Sub-Fund's launch date for all types of share classes is levied at the launch date of Share Classes and paid out in a single instalment within five months of the Share Classes launch date. This Placement Fee is then amortized over a 5-year period of the Sub-Fund. The Management Company has discretion to levy a lower Placement Fee.
- An exit fee of up to 2.50% of initial NAV at Sub-Fund's launch date for all types of share classes is levied at the launch of the single Share Class. The exit fee will remain in the Share Class and is calculated as a fix amount per Share of Share Class. The amount will be reduced by up to 0.25% of the initial NAV at launch date on a semi-annual basis.
- The Management Company intends to limit subscriptions such that selected share classes will be closed for subscriptions after the end of a subscription period to be determined yet. This closure for subscriptions might not necessarily rely on market conditions and can be decided on a discretionary basis by the Management Company.
- The Sub-Fund may only be acquired by Allianz SE, its subsidiaries and their clients.
- The Management Company has the intention – but is legally not obliged – to liquidate or merge the Sub-Fund into another UCITS or UCI after 5 to 9 years after the Sub-Fund's launch date.

Allianz Global Credit SRI

Investor Profile

Allianz Global Credit SRI is aimed at investors who pursue the objective of general capital formation/asset optimisation. It may not be suitable for investors who wish to withdraw their capital from the Sub-Fund within a period of 3 years. Allianz Global Credit SRI is aimed at investors with basic knowledge and/or experience of financial products. Prospective investors should be capable of bearing a financial loss and should not attach any importance to capital protection.

Other Provisions / Restrictions / Additional Information

-

Allianz Global Diversified Dividend

Investor Profile

Allianz Global Diversified Dividend is aimed at investors who pursue the objective of general capital formation/asset optimisation and/or above-average participation in price changes. It may not be suitable for investors who wish to withdraw their capital from the Sub-Fund within a period of 5 years. Allianz Global Diversified Dividend is aimed at investors with basic knowledge and/or experience of financial products. Prospective investors should be capable of bearing a financial loss and should not attach any importance to capital protection.

Other Provisions / Restrictions / Additional Information

-

Allianz Global Dividend

Investor Profile

Allianz Global Dividend is aimed at investors who pursue the objective of general capital formation/asset optimisation and/or above-average participation in price changes. It may not be suitable for investors who wish to withdraw their capital from the Sub-Fund within a period of 5 years. Allianz Global Dividend is aimed at investors with basic knowledge and/or experience of financial products. Prospective investors should be capable of bearing a financial loss and should not attach any importance to capital protection.

Other Provisions / Restrictions / Additional Information

-

Allianz Global Dynamic Multi Asset Income

Investor Profile

Allianz Global Dynamic Multi Asset Income is aimed at investors who pursue the objective of general capital formation/asset optimisation. It may not be suitable for investors who wish to withdraw their capital from the Sub-Fund within a period of 3 years. Allianz Global Dynamic Multi Asset Income is aimed at investors with basic knowledge and/or experience of financial products. Prospective investors should be capable of bearing a financial loss and should not attach any importance to capital protection.

Other Provisions / Restrictions / Additional Information

-

Allianz Global Emerging Markets Equity Dividend

Investor Profile

Allianz Global Emerging Markets Equity Dividend is aimed at investors who pursue the objective of general capital formation/asset optimisation and/or above-average participation in price changes. It may not be suitable for investors who wish to withdraw their capital from the Sub-Fund within a period of 5 years. Allianz Global Emerging Markets Equity Dividend is aimed at investors with basic knowledge and/or experience of financial products. Prospective investors should be capable of bearing a financial loss and should not attach any importance to capital protection.

Other Provisions / Restrictions / Additional Information

- The Subscription Price of the Shares must be received by the Company in cleared funds within three Valuation Days after the calculation of the Subscription Price, applicable for all Share Classes. The Redemption Price will be paid out within three Valuation Days after calculation the Redemption Price, applicable for all Share Classes.

Allianz Global Equity Growth

Investor Profile

Allianz Global Equity Growth is aimed at investors who pursue the objective of general capital formation/asset optimisation and/or above-average participation in price changes. It may not be suitable for investors who wish to withdraw their capital from the Sub-Fund within a period of 5 years. Allianz Global Equity Growth is aimed at investors with basic knowledge and/or experience of financial products. Prospective investors should be capable of bearing a financial loss and should not attach any importance to capital protection.

Other Provisions / Restrictions / Additional Information

-

Allianz Global Equity Insights

Investor Profile

Allianz Global Equity Insights is aimed at investors who pursue the objective of general capital formation/asset optimisation and/or above-average participation in price changes. It may not be suitable for investors who wish to withdraw their capital from the Sub-Fund within a period of 5 years. Allianz Global Equity Insights is aimed at investors with basic knowledge and/or experience of financial products. Prospective investors should be capable of bearing a financial loss and should not attach any importance to capital protection.

Other Provisions / Restrictions / Additional Information

-

Allianz Global Equity powered by Artificial Intelligence

Investor Profile

Allianz Global Equity powered by Artificial Intelligence is aimed at investors who pursue the objective of general capital formation/asset optimisation and/or above-average participation in price changes. It may not be suitable for investors who wish to withdraw their capital from the Sub-Fund within a period of 5 years. Allianz Global Equity powered by Artificial Intelligence is aimed at investors with basic knowledge and/or experience of financial products. Prospective investors should be capable of bearing a financial loss and should not attach any importance to capital protection.

Other Provisions / Restrictions / Additional Information

-

Allianz Global Equity Unconstrained

Investor Profile

Allianz Global Equity Unconstrained is aimed at investors who pursue the objective of general capital formation/asset optimisation and/or above-average participation in price changes. It may not be suitable for investors who wish to withdraw their capital from the Sub-Fund within a period of 5 years. Allianz Global Equity Unconstrained is aimed at investors with basic knowledge and/or experience of financial products. Prospective investors should be capable of bearing a financial loss and should not attach any importance to capital protection.

Other Provisions / Restrictions / Additional Information

- Shares of Share Classes C2 and CT2 may only be acquired by investors who are clients of Hellenic Bank or its affiliates.
- The minimum subscription amount for the investment in Shares of the Share Class C2 and CT2 (after deduction of any Sales Charge) is EUR 1 million or equivalent in other currencies. In certain cases, the Management Company has discretion to permit lower minimum investments.

Allianz Global Floating Rate Notes Plus

Investor Profile

Allianz Global Floating Rate Notes Plus is aimed at investors who prioritise safety and/or pursue the objective of general capital formation/asset optimisation. It may not be suitable for investors who wish to withdraw their capital from the Sub-Fund within a period of 1 year. Allianz Global Floating Rate Notes Plus is aimed at investors with basic knowledge and/or experience of financial products. Prospective investors should be capable of bearing a financial loss and should not attach any importance to capital protection.

Other Provisions / Restrictions / Additional Information

- Shares of Share Classes A3/AT3 may only be acquired by investors who are clients of UBS Switzerland AG and its affiliates or Singular Bank S.A.U. and its affiliates.
- Share Class C2/CT2 and C3/CT3 will be closed after the end of the initial offer period.
- A redemption fee of up to 1.00% of Share Class C2's and C3's Net Asset Value is levied within the first year after the Share Class C2's or C3's launch date, thereafter no redemption fee will be charged.
- Shares of Share Classes R10/RT10 may only be acquired by investors who are clients of UBS Switzerland AG and its affiliates or Singular Bank S.A.U. and its affiliates, and who have individual fee arrangements with UBS Switzerland AG and its affiliates or Singular Bank S.A.U. and its affiliates.
- The minimum subscription amounts for the investment in Shares in Share Classes A3/AT3 (after deduction of any Sales Charge) is EUR 75,000 or equivalent in other currencies. In certain cases, the Management Company has discretion to permit lower minimum investments.
- The minimum subscription amounts for the investment in Shares in Share Classes R10/RT10 (after deduction of any Sales Charge) is EUR 100 million or equivalent in other currencies. In certain cases, the Management Company has discretion to permit lower minimum investments.

Allianz Global Government Bond

Investor Profile

Allianz Global Government Bond is aimed at investors who prioritise safety and/or pursue the objective of general capital formation/asset optimisation. It may not be suitable for investors who wish to withdraw their capital from the Sub-Fund within a period of 4 years. Allianz Global Government Bond is aimed at investors with basic knowledge and/or experience of financial products. Prospective investors should be capable of bearing a financial loss and should not attach any importance to capital protection.

Other Provisions / Restrictions / Additional Information

-

Allianz Global High Yield

Investor Profile

Allianz Global High Yield is aimed at investors who pursue the objective of general capital formation/asset optimisation. It may not be suitable for investors who wish to withdraw their capital from the Sub-Fund within a period of 4 years. Allianz Global High Yield is aimed at investors with basic knowledge and/or experience of financial products. Prospective investors should be capable of bearing a financial loss and should not attach any importance to capital protection.

Other Provisions / Restrictions / Additional Information

- Share Class C2/CT2 and C3/CT3 will be closed after the end of the initial offer period.
- A redemption fee of up to 1.00% of Share Class C2's and C3's Net Asset Value is levied within the first year after the Share Class C2's or C3's launch date; thereafter no redemption fee will be charged.

Allianz Global Hi-Tech Growth

Investor Profile

Allianz Global Hi-Tech Growth is aimed at investors who pursue the objective of general capital formation/asset optimisation and/or above-average participation in price changes. It may not be suitable for investors who wish to withdraw their capital from the Sub-Fund within a period of 5 years. Allianz Global Hi-Tech Growth is aimed at investors with basic knowledge and/or experience of financial products. Prospective investors should be capable of bearing a financial loss and should not attach any importance to capital protection.

Other Provisions / Restrictions / Additional Information

-

Allianz Global Income

Investor Profile

Allianz Global Income is aimed at investors who pursue the objective of general capital formation/asset optimisation and/or above-average participation in price changes. It may not be suitable for investors who wish to withdraw their capital from the Sub-Fund within a period of 4 years. Allianz Global Income is aimed at investors with basic knowledge and/or experience of financial products. Prospective investors should be capable of bearing a financial loss and should not attach any importance to capital protection.

Other Provisions / Restrictions / Additional Information

-

Allianz Global Inflation-Linked Bond

Investor Profile

Allianz Global Inflation-Linked Bond is aimed at investors who pursue the objective of general capital formation/asset optimisation. It may not be suitable for investors who wish to withdraw their capital from the Sub-Fund within a period of 3 years. Allianz Global Inflation-Linked Bond is aimed at investors with basic knowledge and/or experience of financial products. Prospective investors should be capable of bearing a financial loss and should not attach any importance to capital protection.

Other Provisions / Restrictions / Additional Information

-

Allianz Global Intelligent Cities Income

Investor Profile

Allianz Global Intelligent Cities Income is aimed at investors who pursue the objective of general capital formation/asset optimisation and/or above-average participation in price changes. It may not be suitable for investors who wish to withdraw their capital from the Sub-Fund within a period of 4 years. Allianz Global Intelligent Cities Income is aimed at investors with basic knowledge and/or experience of financial products. Prospective investors should be capable of bearing a financial loss and should not attach any importance to capital protection.

Other Provisions / Restrictions / Additional Information

- Placement fee of up to 2.50% of Share Classes C6/CT6's and W6/WT6's initial Net Asset Value is levied at the launch date of Share Classes C6/CT6 and W6/WT6 and paid out in a single instalment within five months of the Share Classes C6/CT6's and W6/WT6's launch date. This Placement Fee is then amortized over a 5-year period of the Sub-Fund. The Management Company has discretion to levy a lower Placement Fee.
- An exit fee of up to 2.50% of Share Classes C6/CT6's and W6/WT6's initial Net Asset Value is levied at the launch of Share Classes C6/CT6 and W6/WT6. The exit fee will remain in the Share Classes C6/CT6 and W6/WT6 and is calculated as a fix amount per Share of Share Classes C6/CT6 and W6/WT6. The amount will be reduced by up to 0.25 % of the initial NAV at launch date on a semi-annual basis.

Allianz Global Metals and Mining

Investor Profile

Allianz Global Metals and Mining is aimed at investors who pursue the objective of general capital formation/asset optimisation and/or above-average participation in price changes. It may not be suitable for investors who wish to withdraw their capital from the Sub-Fund within a period of 5 years. Allianz Global Metals and Mining is aimed at investors with basic knowledge and/or experience of financial products. Prospective investors should be capable of bearing a financial loss and should not attach any importance to capital protection.

Other Provisions / Restrictions / Additional Information

-

Allianz Global Multi-Asset Credit

Investor Profile

Allianz Global Multi-Asset Credit is aimed at investors who pursue the objective of general capital formation/asset optimisation. It may not be suitable for investors who wish to withdraw their capital from the Sub-Fund within a period of 4 years. Allianz Global Multi-Asset Credit is aimed at investors with basic knowledge and/or experience of financial products. Prospective investors should be capable of bearing a financial loss and should not attach any importance to capital protection.

Other Provisions / Restrictions / Additional Information

-

Allianz Global Multi-Asset Credit SRI

Investor Profile

Allianz Global Multi-Asset Credit SRI is aimed at investors who pursue the objective of general capital formation/asset optimisation. It may not be suitable for investors who wish to withdraw their capital from the Sub-Fund within a period of 4 years. Allianz Global Multi-Asset Credit SRI is aimed at investors with basic knowledge and/or experience of financial products. Prospective investors should be capable of bearing a financial loss and should not attach any importance to capital protection.

Other Provisions / Restrictions / Additional Information

-

Allianz Global Multi Asset Sustainability Balanced

Investor Profile

Allianz Global Multi Asset Sustainability Balanced is aimed at investors who pursue the objective of general capital formation/asset optimisation. It may not be suitable for investors who wish to withdraw their capital from the Sub-Fund within a period of 4 years. Allianz Global Multi Asset Sustainability Balanced is aimed at investors with basic knowledge and/or experience of financial products. Prospective investors should be capable of bearing a financial loss and should not attach any importance to capital protection.

Other Provisions / Restrictions / Additional Information

- The Subscription Price of the Shares must be received by the Company in cleared funds within three Valuation Days after the calculation of the Subscription Price. The Redemption Price will be paid out within three Valuation Days after calculation the Redemption Price.

Allianz Global Multi Asset Sustainability Conservative

Investor Profile

Allianz Global Multi Asset Sustainability Conservative is aimed at investors who pursue the objective of general capital formation/asset optimisation. It may not be suitable for investors who wish to withdraw their capital from the Sub-Fund within a period of 3 years. Allianz Global Multi Asset Sustainability Conservative is aimed at investors with basic knowledge and/or experience of financial products. Prospective investors should be capable of bearing a financial loss and should not attach any importance to capital protection.

Other Provisions / Restrictions / Additional Information

- The Subscription Price of the Shares must be received by the Company in cleared funds within three Valuation Days after the calculation of the Subscription Price. The Redemption Price will be paid out within three Valuation Days after calculation the Redemption Price.

Allianz Global Multi Asset Sustainability Growth

Investor Profile

Allianz Global Multi Asset Sustainability Growth is aimed at investors who pursue the objective of general capital formation/asset optimisation. It may not be suitable for investors who wish to withdraw their capital from the Sub-Fund within a period of 4 years. Allianz Global Multi Asset Sustainability Growth is aimed at investors with basic knowledge and/or experience of financial products. Prospective investors should be capable of bearing a financial loss and should not attach any importance to capital protection.

Other Provisions / Restrictions / Additional Information

- The Subscription Price of the Shares must be received by the Company in cleared funds within three Valuation Days after the calculation of the Subscription Price. The Redemption Price will be paid out within three Valuation Days after calculation the Redemption Price.

Allianz Global Opportunistic Bond

Investor Profile

Allianz Global Opportunistic Bond is aimed at investors who pursue the objective of general capital formation/asset optimisation. It may not be suitable for investors who wish to withdraw their capital from the Sub-Fund within a period of 3 years. Allianz Global Opportunistic Bond is aimed at investors with basic knowledge and/or experience of financial products. Prospective investors should be capable of bearing a financial loss and should not attach any importance to capital protection.

Other Provisions / Restrictions / Additional Information

- Share Class C2/CT2 and C3/CT3 will be closed after the end of the initial offer period except for reinvestment of distributions from Distribution Shares of Share Classes C2/CT2 and C3/CT3.
- A redemption fee of up to 2.00% of Share Class C2's and C3's Net Asset Value is levied within the first two years after the Share Class C2's or C3's launch date; thereafter no redemption fee will be charged.

Allianz Global Small Cap Equity

Investor Profile

Allianz Global Small Cap Equity is aimed at investors who pursue the objective of general capital formation/asset optimisation and/or above-average participation in price changes. It may not be suitable for investors who wish to withdraw their capital from the Sub-Fund within a period of 5 years. Allianz Global Small Cap Equity is aimed at investors with basic knowledge and/or experience of financial products. Prospective investors should be capable of bearing a financial loss and should not attach any importance to capital protection.

Other Provisions / Restrictions / Additional Information

- The minimum subscription amount for the investment in Shares of the Share Class PT2 (GBP) (after deduction of any Sales Charge) is GBP 3 million. In certain cases, the Management Company has discretion to permit lower minimum investments.
- The Subscription Price of the Shares must be received by the Company in cleared funds within three Valuation Days after the calculation of the Subscription Price. The Redemption Price will be paid out within three Valuation Days after calculation the Redemption Price.

Allianz Global Sustainability

Investor Profile

Allianz Global Sustainability is aimed at investors who pursue the objective of general capital formation/asset optimisation and/or above-average participation in price changes. It may not be suitable for investors who wish to withdraw their capital from the Sub-Fund within a period of 5 years. Allianz Global Sustainability is aimed at investors with basic knowledge and/or experience of financial products. Prospective investors should be capable of bearing a financial loss and should not attach any importance to capital protection.

Other Provisions / Restrictions / Additional Information

- The minimum subscription amount for the investment in Shares of the Share Class I2 (EUR) and IT2 (EUR) (after deduction of any Sales Charge) is EUR 500,000. In certain cases, the Management Company has discretion to permit lower minimum investments.
- Shares of Share Classes I4 (EUR) and IT4 (EUR) may only be acquired by Allianz Nederland Levensverzekering and/or Allianz Benelux.
- Shares of Share Class IT8 (EUR) may only be acquired for clients domiciled in Italy which have signed a discretionary investment management agreement with the Management Company.

Allianz Global Water

Investor Profile

Allianz Global Water is aimed at investors who pursue the objective of general capital formation/asset optimisation and/or above-average participation in price changes. It may not be suitable for investors who wish to withdraw their capital from the Sub-Fund within a period of 5 years. Allianz Global Water is aimed at investors with basic knowledge and/or experience of financial products. Prospective investors should be capable of bearing a financial loss and should not attach any importance to capital protection.

Other Provisions / Restrictions / Additional Information

- Shares of Share Class IT4 (EUR) may only be acquired by Allianz SE and its subsidiaries.
- Shares of Share Classes R10, RT10, W7 and WT7 may only be acquired by investors who are clients of UBS Switzerland AG and its affiliates or Singular Bank S.A.U. and its affiliates, and who have individual fee arrangements with UBS Switzerland AG and its affiliates or Singular Bank S.A.U. and its affiliates.
- Shares of Share Classes A3 and AT3 may only be acquired by investors who are clients of UBS Switzerland AG and its affiliates or Singular Bank S.A.U. and its affiliates.
- Shares of Share Classes A4, AT4, R11, RT11 and W8, WT8 may only be acquired by JP Morgan or its affiliates.

- The minimum subscription amount for the investment in Shares of Share Classes R10, RT10, W7 and WT7 (after deduction of any Sales Charge) is EUR 500 million or equivalent in other currencies. In certain cases, the Management Company has discretion to permit lower minimum investments.
- The minimum subscription amount for the investment in Shares of Share Classes A3 and AT3 (after deduction of any Sales Charge) is EUR 75,000 or equivalent in other currencies. In certain cases, the Management Company has discretion to permit lower minimum investments.

Allianz Green Bond

Investor Profile

Allianz Green Bond is aimed at investors who pursue the objective of general capital formation/asset optimisation. It may not be suitable for investors who wish to withdraw their capital from the Sub-Fund within a period of 3 years. Allianz Green Bond is aimed at investors with basic knowledge and/or experience of financial products. Prospective investors should be capable of bearing a financial loss and should not attach any importance to capital protection.

Other Provisions / Restrictions / Additional Information

- The minimum subscription amount for the investment in Shares of the Share Class AT3 (H2-SEK) (after deduction of any Sales Charge) is SEK 500,000. In certain cases, the Management Company has discretion to permit lower minimum investments.
- Shares of Share Class IT4 (EUR) may only be acquired by Allianz SE and its subsidiaries.

Allianz Green Future

Investor Profile

Allianz Green Future is aimed at investors who pursue the objective of general capital formation/asset optimisation and/or above-average participation in price changes. It may not be suitable for investors who wish to withdraw their capital from the Sub-Fund within a period of 3 years. Allianz Green Future is aimed at investors with basic knowledge and/or experience of financial products. Prospective investors should be capable of bearing a financial loss and should not attach any importance to capital protection.

Other Provisions / Restrictions / Additional Information

- A placement fee of up to 2.50% of Share Classes C/CT's and W6/WT6's initial Net Asset Value is levied at the launch date of Share Classes C/CT and W6/WT6 and paid out in a single instalment within five months of the Share Classes C/CT's and W6/WT6's launch date. This Placement Fee is then amortized over a 5-year period of the Sub-Fund. The Management Company has discretion to levy a lower Placement Fee.
- An exit fee of up to 2.50% of Share Classes C/CT's and W6/WT6's initial Net Asset Value is levied at the launch of Share Classes C/CT and W6/WT6. The exit fee will remain in the Share Classes C/CT and W6/WT6 and is calculated as a fix amount per Share of Share Classes C/CT and W6/WT6. The amount will be reduced by up to 0.50% of the initial NAV at launch date on an annual basis.
- The Management Company intends to limit subscriptions such that selected share classes will be closed for subscriptions after the end of a subscription period to be determined yet. This closure for subscriptions might not necessarily rely on market conditions and can be decided on a discretionary basis by the Management Company.
- The Management Company has the intention – but is legally not obliged – to liquidate or merge the Sub-Fund into another UCITS or UCI after 5 to 9 years after the Sub-Fund's launch date.

Allianz Green Transition Bond

Investor Profile

Allianz Green Transition Bond is aimed at investors who pursue the objective of general capital formation/asset optimisation and/or above-average participation in price changes. It may not be suitable for investors who wish to withdraw their capital from the Sub-Fund within a period of 4 years. Allianz Green Transition Bond is aimed at investors with basic knowledge and/or experience of financial products. Prospective investors should be capable of bearing a financial loss and should not attach any importance to capital protection.

Other Provisions / Restrictions / Additional Information

- The minimum subscription amount for the investment in Shares in Share Classes W6 and WT6 (after deduction of any Sales Charge) is EUR 50 million or equivalent in other currencies. In certain cases, the Management Company has discretion to permit lower minimum investments.
- Shares of Share Classes W6 and WT6 may only be acquired by Banca March Group or its affiliates.

Allianz High Dividend Asia Pacific Equity

Investor Profile

Allianz High Dividend Asia Pacific Equity is aimed at investors who pursue the objective of general capital formation/asset optimisation and/or above-average participation in price changes. It may not be suitable for investors who wish to withdraw their capital from the Sub-Fund within a period of 5 years. Allianz High Dividend Asia Pacific Equity is aimed at investors with basic knowledge and/or experience of financial products. Prospective investors should be capable of bearing a financial loss and should not attach any importance to capital protection.

Other Provisions / Restrictions / Additional Information

- The Subscription Price of the Shares must be received by the Company in cleared funds within three Valuation Days after the calculation of the Subscription Price. The Redemption Price will be paid out within three Valuation Days after calculation the Redemption Price.

Allianz HKD Income

Investor Profile

Allianz HKD Income is aimed at investors who pursue the objective of general capital formation/asset optimisation. It may not be suitable for investors who wish to withdraw their capital from the Sub-Fund within a period of 2 years. Allianz HKD Income is aimed at investors with basic knowledge and/or experience of financial products. Prospective investors should be capable of bearing a financial loss and should not attach any importance to capital protection.

Other Provisions / Restrictions / Additional Information

- The Subscription Price of the Shares must be received by the Company in cleared funds within three Valuation Days after the calculation of the Subscription Price. The Redemption Price will be paid out within three Valuation Days after calculation the Redemption Price.

Allianz Hong Kong Equity

Investor Profile

Allianz Hong Kong Equity is aimed at investors who pursue the objective of general capital formation/asset optimisation and/or above-average participation in price changes. It may not be suitable for investors who wish to withdraw their capital from the Sub-Fund within a period of 5 years. Allianz Hong Kong Equity is aimed at investors with basic knowledge and/or experience of financial products. Prospective investors should be capable of bearing a financial loss and should not attach any importance to capital protection.

Other Provisions / Restrictions / Additional Information

- The Subscription Price of the Shares must be received by the Company in cleared funds within three Valuation Days after the calculation of the Subscription Price. The Redemption Price will be paid out within three Valuation Days after calculation the Redemption Price.

Allianz Income and Growth

Investor Profile

Allianz Income and Growth is aimed at investors who pursue the objective of general capital formation/asset optimisation. It may not be suitable for investors who wish to withdraw their capital from the Sub-Fund within a period of 4 years. Allianz Income and Growth is aimed at investors with basic knowledge and/or experience of financial products. Prospective investors should be capable of bearing a financial loss and should not attach any importance to capital protection.

Other Provisions / Restrictions / Additional Information

- The minimum subscription amount for the investment in Shares in Share Classes P8 and PT8 (after deduction of any Sales Charge) is EUR 2.4 million or equivalent in other currencies. In certain cases, the Management Company has discretion to permit lower minimum investments.
- Shares of Share Class WT (USD H2-BRL) may only be acquired by a local Brazilian feeder fund administered by XP Inc. or one of its subsidiaries.

Allianz India Equity

Investor Profile

Allianz India Equity is aimed at investors who pursue the objective of general capital formation/asset optimisation and/or above-average participation in price changes. It may not be suitable for investors who wish to withdraw their capital from the Sub-Fund within a period of 5 years. Allianz India Equity is aimed at investors with basic knowledge and/or experience of financial products. Prospective investors should be capable of bearing a financial loss and should not attach any importance to capital protection.

Other Provisions / Restrictions / Additional Information

- The Subscription Price of the Shares must be received by the Company in cleared funds within three Valuation Days after the calculation of the Subscription Price. The Redemption Price will be paid out within three Valuation Days after calculation the Redemption Price.

Allianz Indonesia Equity

Investor Profile

Allianz Indonesia Equity is aimed at investors who pursue the objective of general capital formation/asset optimisation and/or above-average participation in price changes. It may not be suitable for investors who wish to withdraw their capital from the Sub-Fund within a period of 5 years. Allianz Indonesia Equity is aimed at investors with basic knowledge and/or experience of financial products. Prospective investors should be capable of bearing a financial loss and should not attach any importance to capital protection.

Other Provisions / Restrictions / Additional Information

- The Subscription Price of the Shares must be received by the Company in cleared funds within three Valuation Days after the calculation of the Subscription Price. The Redemption Price will be paid out within three Valuation Days after calculation the Redemption Price.

Allianz Japan Equity

Investor Profile

Allianz Japan Equity is aimed at investors who pursue the objective of general capital formation/asset optimisation and/or above-average participation in price changes. It may not be suitable for investors who wish to withdraw their capital from the Sub-Fund within a period of 5 years. Allianz Japan Equity is aimed at investors with basic knowledge and/or experience of financial products. Prospective investors should be capable of bearing a financial loss and should not attach any importance to capital protection.

Other Provisions / Restrictions / Additional Information

- The Subscription Price of the Shares must be received by the Company in cleared funds within three Valuation Days after the calculation of the Subscription Price. The Redemption Price will be paid out within three Valuation Days after calculation the Redemption Price.

Allianz Japan Smaller Companies Equity

Investor Profile

Allianz Japan Smaller Companies Equity is aimed at investors who pursue the objective of general capital formation/asset optimisation and/or above-average participation in price changes. It may not be suitable for investors who wish to withdraw their capital from the Sub-Fund within a period of 5 years. Allianz Japan Smaller Companies Equity is aimed at investors with basic knowledge and/or experience of financial products. Prospective investors should be capable of bearing a financial loss and should not attach any importance to capital protection.

Other Provisions / Restrictions / Additional Information

- The Subscription Price of the Shares must be received by the Company in cleared funds within three Valuation Days after the calculation of the Subscription Price. The Redemption Price will be paid out within three Valuation Days after calculation the Redemption Price.

Allianz Laufzeitfonds

Investor Profile

Allianz Laufzeitfonds is aimed at investors who pursue the objective of general capital formation/asset optimisation and/or above-average participation in price changes. It may not be suitable for investors who wish to withdraw their capital from the Sub-Fund before the maturity date. Allianz Laufzeitfonds is aimed at investors with basic knowledge and/or experience of financial products. Prospective investors should be capable of bearing a financial loss and should not attach any importance to capital protection.

Other Provisions / Restrictions / Additional Information

- All Share Class types may contain the additional name "Allianz Target Maturity Fund" which is placed prior to the Share Class type.
- A placement fee of up to 2.00 % of Share Classes A2/AT2's, C6/CT6's and W6/WT6's initial Net Asset Value is levied at the launch date of Share Classes A2/AT2's, C6/CT6 and W6/WT6 and paid out in a single instalment within two month of the Share Classes A2/AT2's, C6/CT6's and W6/WT6 `s launch date. This Placement Fee is then amortized over the terms of the Sub-Fund. The Management Company has discretion to levy a lower Placement Fee.
- An exit fee of up to 2.00 % of Share Classes A2/AT2's, C6/CT6's and W6/WT6's initial Net Asset Value is levied at the launch of Share Classes A2/AT2's, C6/CT6's and W6/WT6's. The exit fee will remain in the Share Classes A2/AT2's, C6/CT6's and W6/WT6's and is calculated as a fix amount per Share of Share Classes A2/AT2's, C6/CT6's and W6/WT6's. The amount will be reduced by up to 0.50% of the initial NAV at launch date on a semi-annual basis.
- The Management Company has the right - but is not obliged - to close the Sub-Fund or selected share classes for subscriptions after Sub-Fund's launch date. This closure for subscriptions might not necessarily rely on market conditions and can be decided on a discretionary basis by the Management Company.
- Share Classes A2/AT2, C6/CT6 and W6/WT6 will be closed for subscriptions after the end of the subscription period. As these share classes are subject to a Placement Fee an Exit Fee will become effective after the end of the applicable subscription period.

- The Company may, for purposes of orderly settlement and equal treatment of the investors, suspend the redemption of shares two months prior to Maturity Date (provided if it is not a Dealing Day, the next Dealing Day). The Company will publish the liquidation proceeds per share at which the investors may cash in their share certificates on final maturity of the Sub-Fund at the Registrar and Transfer Agent and the Paying Agents. Unclaimed liquidation proceeds shall be deposited at the Caisse de Consignation and will be forfeited if not claimed within the statutory period.
- The Management Company has the right - but is not obliged - to stop the carbon intensity KPI in the last two months prior to the sub-fund's maturity, as maturing bonds are invested in short-term money market/government bonds for which no carbon intensity data is / might be available.
- The term of the Sub-Fund is limited to the Maturity Date; however, the Sub-Fund may be liquidated by resolution of the Company at any time prior to that date or merged as a sub-fund being absorbed prior to that date. The Sub-Fund is also liquidated in the cases listed under Section III.5.
- Subject to any prior liquidation or merger of the Sub-Fund, the Company will begin to sell the Sub-Fund's assets two months prior to Maturity Date and sell all assets, collect receivables and settle liabilities by the Maturity Date.
- The Management Company may charge a Disinvestment Fee of up to 2 % of the Net Asset Value of the Sub-Fund or selected share classes. The Management Company has discretion to levy a lower Disinvestment Fee. The Disinvestment Fee will not be charged by the Management Company during an applicable subscription period.
- The investment strategy of the Sub-Fund is similar to the investment strategy followed by other Sub-Funds of the Company. However, these Sub-Funds may differ from each other on several criteria such as, but not limited to, the initial subscription period, the launch date, the investment horizon or the applicable pricing.
- For all distributing share classes the Company targets to distribute an amount which will be determined individually. However, such amount will in no case exceed the amount distributable by applying the general distribution policy for Distribution Shares.

Allianz Little Dragons

Investor Profile

Allianz Little Dragons is aimed at investors who pursue the objective of general capital formation/asset optimisation and/or above-average participation in price changes. It may not be suitable for investors who wish to withdraw their capital from the Sub-Fund within a period of 5 years. Allianz Little Dragons is aimed at investors with basic knowledge and/or experience of financial products. Prospective investors should be capable of bearing a financial loss and should not attach any importance to capital protection.

Other Provisions / Restrictions / Additional Information

- Share Classes containing the additional denomination "2" may not be acquired by investors who are either domiciled in or permanent residents of an Asian country, Australia or New Zealand. For the purpose of this restriction Afghanistan, Armenia, Azerbaijan, Bahrain, Cyprus, Egypt, Georgian Republic, Iran, Iraq, Israel, Jordan, Kuwait, Lebanon, Oman, Qatar, Russia, Saudi Arabia, Syria, Turkey, the United Arab Emirates, West Bank and Gaza as well as Yemen are not considered to be Asian countries.
- The Subscription Price of the Shares must be received by the Company in cleared funds within three Valuation Days after the calculation of the Subscription Price. The Redemption Price will be paid out within three Valuation Days after calculation the Redemption Price.

Allianz Metaverse

Investor Profile

Allianz Metaverse is aimed at investors who pursue the objective of general capital formation/asset optimisation and/or above-average participation in price changes. It may not be suitable for investors who wish to withdraw their capital from the Sub-Fund within a period of 5 years. Allianz Metaverse is aimed at investors with basic knowledge and/or experience of financial products. Prospective investors should be capable of bearing a financial loss and should not attach any importance to capital protection.

Other Provisions / Restrictions / Additional Information

-

Allianz Multi Asset Long / Short

Investor Profile

Allianz Multi Asset Long / Short is aimed at investors who pursue the objective of general capital formation/asset optimisation and/or above-average participation in price changes. It may not be suitable for investors who wish to withdraw their capital from the Sub-Fund within a period of 5 years. Allianz Multi Asset Long / Short is aimed at investors with basic knowledge and/or experience of financial products. Prospective investors should be capable of bearing a financial loss and should not attach any importance to capital protection.

Other Provisions / Restrictions / Additional Information

- Shares of Share Class I14(H2-JPY) may only be acquired by AllianzGI Japan's local (Japan domiciled) funds.
- Shares of Share Class WT2 (H2-EUR) may only be acquired by Allianz SE and its subsidiaries.

Allianz Multi Asset Opportunities

Investor Profile

Allianz Multi Asset Opportunities is aimed at investors who pursue the objective of general capital formation/asset optimisation and/or above-average participation in price changes. It may not be suitable for investors who wish to withdraw their capital from the Sub-Fund within a period of 5 years. Allianz Multi Asset Opportunities is aimed at investors with basic knowledge and/or experience of financial products. Prospective investors should be capable of bearing a financial loss and should not attach any importance to capital protection.

Other Provisions / Restrictions / Additional Information

- Shares of Share Class I14(H2-JPY) may only be acquired by AllianzGI Japan's local (Japan domiciled) funds.
- Shares of Share Class WT2 (H2-EUR) may only be acquired by Allianz SE and its subsidiaries.

Allianz Multi Asset Risk Premia

Investor Profile

Allianz Multi Asset Risk Premia is aimed at investors who pursue the objective of general capital formation/asset optimisation and/or above-average participation in price changes. It may not be suitable for investors who wish to withdraw their capital from the Sub-Fund within a period of 5 years. Allianz Multi Asset Risk Premia is aimed at investors with basic knowledge and/or experience of financial products. Prospective investors should be capable of bearing a financial loss and should not attach any importance to capital protection.

Other Provisions / Restrictions / Additional Information

- The minimum subscription amount for the investment in Shares in Share Classes P3 and PT3 (after deduction of any Sales Charge) is EUR 3 million or equivalent in other currencies. In certain cases, the Management Company has discretion to permit lower minimum investments.
- Shares of Share Class I14(H2-JPY) may only be acquired by AllianzGI Japan's local (Japan domiciled) funds.

Allianz Oriental Income

Investor Profile

Allianz Oriental Income is aimed at investors who pursue the objective of general capital formation/asset optimisation and/or above-average participation in price changes. It may not be suitable for investors who wish to withdraw their capital from the Sub-Fund within a period of 5 years. Allianz Oriental Income is aimed at investors with basic knowledge and/or experience of financial products. Prospective investors should be capable of bearing a financial loss and should not attach any importance to capital protection.

Other Provisions / Restrictions / Additional Information

- Share Class A2 (EUR) contains the additional name "Ertrag Asien Pazifik" which is placed prior to "A2 (EUR)".
- The Subscription Price of the Shares must be received by the Company in cleared funds within three Valuation Days after the calculation of the Subscription Price. The Redemption Price will be paid out within three Valuation Days after calculation the Redemption Price.

Allianz Pet and Animal Wellbeing

Investor Profile

Allianz Pet and Animal Wellbeing is aimed at investors who pursue the objective of general capital formation/asset optimisation and/or above-average participation in price changes. It may not be suitable for investors who wish to withdraw their capital from the Sub-Fund within a period of 5 years. Allianz Pet and Animal Wellbeing is aimed at investors with basic knowledge and/or experience of financial products. Prospective investors should be capable of bearing a financial loss and should not attach any importance to capital protection.

Other Provisions / Restrictions / Additional Information

- The minimum subscription amount for the investment in Shares in Share Classes P2 and PT2 (after deduction of any Sales Charge) is USD 3 million or equivalent in other currencies. In certain cases, the Management Company has discretion to permit lower minimum investments.

Allianz Positive Change

Investor Profile

Allianz Positive Change is aimed at investors who pursue the objective of general capital formation/asset optimisation and/or above-average participation in price changes. It may not be suitable for investors who wish to withdraw their capital from the Sub-Fund within a period of 5 years. Allianz Positive Change is aimed at investors with basic knowledge and/or experience of financial products. Prospective investors should be capable of bearing a financial loss and should not attach any importance to capital protection.

Other Provisions / Restrictions / Additional Information

- Placement fee of up to 3.00% of Share Classes C6/CT6's and W6/WT6's initial Net Asset Value is levied at the launch date of Share Classes C6/CT6 and W6/WT6 and paid out in a single instalment within five months of the Share Classes C6/CT6's and W6/WT6's launch date. This Placement Fee is then amortized over a 5-year period of the Sub-Fund. The Management Company has discretion to levy a lower Placement Fee.
- An exit fee of up to 3.00% of Share Classes C6/CT6's and W6/WT6's initial Net Asset Value is levied at the launch of Share Classes C6/CT6 and W6/WT6. The exit fee will remain in the Share Classes C6/CT6 and W6/WT6 and is calculated as a fixed amount per Share of Share Classes C6/CT6 and W6/WT6. The amount will be reduced by up to 0.30% of the initial NAV at launch date on a semi-annual basis.

Allianz Premium Champions

Investor Profile

Allianz Premium Champions is aimed at investors who pursue the objective of general capital formation/asset optimisation and/or above-average participation in price changes. It may not be suitable for investors who wish to withdraw their capital from the fund within a period of 5 years. Allianz Premium Champions is aimed at investors with basic knowledge and/or experience of financial products. Prospective investors should be capable of bearing a financial loss and should not attach any importance to capital protection.

Other Provisions / Restrictions / Additional Information

-

Allianz Renminbi Fixed Income

Investor Profile

Allianz Renminbi Fixed Income is aimed at investors who prioritise safety and/or pursue the objective of general capital formation/asset optimisation. It may not be suitable for investors who wish to withdraw their capital from the Sub-Fund within a period of 4 years. Allianz Renminbi Fixed Income is aimed at investors with basic knowledge and/or experience of financial products. Prospective investors should be capable of bearing a financial loss and should not attach any importance to capital protection.

Other Provisions / Restrictions / Additional Information

- The Subscription Price of the Shares must be received by the Company in cleared funds within five Valuation Days after the calculation of the Subscription Price, applicable for all Share Classes. The Redemption Price will be paid out within five Valuation Days after calculation the Redemption Price, applicable for all Share Classes.

Allianz SDG Euro Credit

Investor Profile

Allianz SDG Euro Credit is aimed at investors who pursue the objective of general capital formation/asset optimisation. It may not be suitable for investors who wish to withdraw their capital from the Sub-Fund within a period of 3 years. Allianz SDG Euro Credit is aimed at investors with basic knowledge and/or experience of financial products. Prospective investors should be capable of bearing a financial loss and should not attach any importance to capital protection.

Other Provisions / Restrictions / Additional Information

- Shares of Share Class IT8 (EUR) may only be acquired for clients domiciled in Italy which have signed a discretionary investment management agreement with the Management Company.

Allianz Select Income and Growth

Investor Profile

Allianz Select Income and Growth is aimed at investors who pursue the objective of general capital formation/asset optimisation. It may not be suitable for investors who wish to withdraw their capital from the Sub-Fund within a period of 4 years. Allianz Select Income and Growth is aimed at investors with basic knowledge and/or experience of financial products. Prospective investors should be capable of bearing a financial loss and should not attach any importance to capital protection.

Other Provisions / Restrictions / Additional Information

- The minimum subscription amount for the investment in Shares in Share Classes P8 and PT8 (after deduction of any Sales Charge) is EUR 2.4 million or equivalent in other currencies. In certain cases, the Management Company has discretion to permit lower minimum investments.

Allianz SDG Global Equity

Investor Profile

Allianz SDG Global Equity is aimed at investors who pursue the objective of general capital formation/asset optimisation and/or above-average participation in price changes. It may not be suitable for investors who wish to withdraw their capital from the Sub-Fund within a period of 5 years. Allianz SDG Global Equity is aimed at investors with basic knowledge and/or experience of financial products. Prospective investors should be capable of bearing a financial loss and should not attach any importance to capital protection.

Other Provisions / Restrictions / Additional Information

-

Allianz Selection Alternative

Investor Profile

Allianz Selection Alternative is aimed at investors who pursue the objective of general capital formation/asset optimisation and/or above-average participation in price changes. It may not be suitable for investors who wish to withdraw their capital from the Sub-Fund within a period of 5 years. Allianz Selection Alternative is aimed at investors with basic knowledge and/or experience of financial products. Prospective investors should be capable of bearing a financial loss and should not attach any importance to capital protection.

Other Provisions / Restrictions / Additional Information

- The Subscription Price of the Shares must be received by the Company in cleared funds within three Valuation Days after the calculation of the Subscription Price, applicable for all Share Classes. The Redemption Price will be paid out within three Valuation Days after calculation the Redemption Price, applicable for all Share Classes.
- Share Class types A/AT and R/RT may contain the additional name "Allianz Stratégies Opportunistes" which is placed prior to the Share Class type.
- Shares of Share Classes Allianz Stratégies Opportunistes AT (EUR), R/RT, and Allianz Stratégies Opportunistes R/RT (EUR) may only be acquired by Allianz France and its subsidiaries.

Allianz Selection Fixed Income

Investor Profile

Allianz Selection Fixed Income is aimed at investors who pursue the objective of general capital formation/asset optimisation. It may not be suitable for investors who wish to withdraw their capital from the Sub-Fund within a period of 4 years. Allianz Selection Fixed Income is aimed at investors with basic knowledge and/or experience of financial products. Prospective investors should be capable of bearing a financial loss and should not attach any importance to capital protection.

Other Provisions / Restrictions / Additional Information

- The Subscription Price of the Shares must be received by the Company in cleared funds within three Valuation Days after the calculation of the Subscription Price, applicable for all Share Classes. The Redemption Price will be paid out within three Valuation Days after calculation the Redemption Price, applicable for all Share Classes.
- Share Class types A/AT and R/RT may contain the additional name "Allianz Stratégies Obligataires" which is placed prior to the Share Class type.
- Shares of Share Classes Allianz Stratégies Obligataires AT (EUR), R/RT, and Allianz Stratégies Obligataires R/RT (EUR) may only be acquired by Allianz France and its subsidiaries.

Allianz Selection Small and Mid Cap Equity

Investor Profile

Allianz Selection Small and Mid Cap Equity is aimed at investors who pursue the objective of general capital formation/asset optimisation and/or above-average participation in price changes. It may not be suitable for investors who wish to withdraw their capital from the Sub-Fund within a period of 5 years. Allianz Selection Small and Mid Cap Equity is aimed at investors with basic knowledge and/or experience of financial products. Prospective investors should be capable of bearing a financial loss and should not attach any importance to capital protection.

Other Provisions / Restrictions / Additional Information

- The Subscription Price of the Shares must be received by the Company in cleared funds within three Valuation Days after the calculation of the Subscription Price, applicable for all Share Classes. The Redemption Price will be paid out within three Valuation Days after calculation the Redemption Price, applicable for all Share Classes.
- Share Class type A/AT may contain the additional name "Allianz Stratégies PME-ETI" which is placed prior to the Share Class type.
- Shares of Share Class Allianz Stratégies PME-ETI AT (EUR) may only be acquired by Allianz France and its subsidiaries.

Allianz Selective Global High Income

Investor Profile

Allianz Selective Global High Income is aimed at investors who pursue the objective of general capital formation/asset optimisation. It may not be suitable for investors who wish to withdraw their capital from the Sub-Fund within a period of 4 years. Allianz Selective Global High Income is aimed at investors with basic knowledge and/or experience of financial products. Prospective investors should be capable of bearing a financial loss and should not attach any importance to capital protection.

Other Provisions / Restrictions / Additional Information

- The minimum subscription amount for the investment in Shares in Share Classes PT9 (H2-EUR) and PT9 (USD) (after deduction of any Sales Charge) is respectively EUR 5 million and USD 5 million or equivalent in other currencies. In certain cases, the Management Company has discretion to permit lower minimum investments.

Allianz SGD Income

Investor Profile

Allianz SGD Income is aimed at investors who pursue the objective of general capital formation/asset optimisation. It may not be suitable for investors who wish to withdraw their capital from the Sub-Fund within a period of 4 years. Allianz SGD Income is aimed at investors with basic knowledge and/or experience of financial products. Prospective investors should be capable of bearing a financial loss and should not attach any importance to capital protection.

Other Provisions / Restrictions / Additional Information

- The Subscription Price of the Shares must be received by the Company in cleared funds within three Valuation Days after the calculation of the Subscription Price, applicable for all Share Classes. The Redemption Price will be paid out within three Valuation Days after calculation the Redemption Price, applicable for all Share Classes.
- Share Class C/CT will be closed after the end of the initial offer period.
- A redemption fee of up to 2.00% of Share Class C2's initial Net Asset Value is levied at the launch date of Share Class C2 within the first 2 years after the Share Class C2's launch date; thereafter no redemption fee will be charged.
- A placement fee of up to 2.00% of Share Class C3's initial Net Asset Value is levied at the launch of Share Class C3 and paid out in a single instalment within two months after Share Class C3's launch date. This Placement Fee is then amortized over a 2-year period of the Sub-Fund. The Management Company has discretion to levy a lower Placement Fee.
- An exit fee of up to 2.00% of Share Class C3's initial Net Asset Value is levied at the launch of Share Class C3. The exit fee will remain in Share Class C3 and is calculated as a fix amount per Share of Share Class C3. The amount will be reduced by 0.50% of Share Class C3's initial Net Asset Value at Share Class C3's launch date on a semi-annual basis.

Allianz Short Duration Global Bond SRI

Investor Profile

Allianz Short Duration Global Bond SRI is aimed at investors who pursue the objective of general capital formation/asset optimisation. It may not be suitable for investors who wish to withdraw their capital from the Sub-Fund within a period of 2 years. Allianz Short Duration Global Bond SRI is aimed at investors with basic knowledge and/or experience of financial products. Prospective investors should be capable of bearing a financial loss and should not attach any importance to capital protection.

Other Provisions / Restrictions / Additional Information

-

Allianz Smart Energy

Investor Profile

Allianz Smart Energy is aimed at investors who pursue the objective of general capital formation/asset optimisation and/or above-average participation in price changes. It may not be suitable for investors who wish to withdraw their capital from the Sub-Fund within a period of 5 years. Allianz Smart Energy is aimed at investors with basic knowledge and/or experience of financial products. Prospective investors should be capable of bearing a financial loss and should not attach any importance to capital protection.

Other Provisions / Restrictions / Additional Information

- Placement fee of up to 3.00% of Share Classes C6/CT6's and W6/WT6's initial Net Asset Value is levied at the launch date of Share Classes C6/CT6 and W6/WT6 and paid out in a single instalment within five months of the Share Classes C6/CT6's and W6/WT6's launch date. This Placement Fee is then amortized over a 5-year period of the Sub-Fund. The Management Company has discretion to levy a lower Placement Fee.
- An exit fee of up to 3.00% of Share Classes C6/CT6's and W6/WT6's initial Net Asset Value is levied at the launch of Share Classes C6/CT6 and W6/WT6. The exit fee will remain in the Share Classes C6/CT6 and W6/WT6 and is calculated as a fixed amount per Share of Share Classes C6/CT6 and W6/WT6. The amount will be reduced by up to 0.30% of the initial NAV at launch date on a semi-annual basis.

Allianz Social Conviction Equity

Investor Profile

Allianz Social Conviction Equity is aimed at investors who pursue the objective of general capital formation/asset optimisation and/or above-average participation in price changes. It may not be suitable for investors who wish to withdraw their capital from the Sub-Fund within a period of 5 years. Allianz Social Conviction Equity is aimed at investors with basic knowledge and/or experience of financial products. Prospective investors should be capable of bearing a financial loss and should not attach any importance to capital protection.

Other Provisions / Restrictions / Additional Information

-

Allianz Strategic Bond

Investor Profile

Allianz Strategic Bond is aimed at investors who pursue the objective of general capital formation/asset optimisation. It may not be suitable for investors who wish to withdraw their capital from the Sub-Fund within a period of 4 years. Allianz Strategic Bond is aimed at investors with basic knowledge and/or experience of financial products. Prospective investors should be capable of bearing a financial loss and should not attach any importance to capital protection.

Other Provisions / Restrictions / Additional Information

-

Allianz Strategy Select 30

Investor Profile

Allianz Strategy Select 30 is aimed at investors who pursue the objective of general capital formation/asset optimisation. It may not be suitable for investors who wish to withdraw their capital from the Sub-Fund within a period of 3 years. Allianz Strategy Select 30 is aimed at investors with basic knowledge and/or experience of financial products. Prospective investors should be capable of bearing a financial loss and should not attach any importance to capital protection.

Other Provisions / Restrictions / Additional Information

- Shares of all Share Classes may only be acquired by Allianz SE and its subsidiaries.
- The minimum subscription amount for the investment in Shares of all types of I/IT share classes (after deduction of any Sales Charge) is EUR 25 million. In certain cases, the Management Company has discretion to permit lower minimum investments.

Allianz Strategy Select 50

Investor Profile

Allianz Strategy Select 50 is aimed at investors who pursue the objective of general capital formation/asset optimisation. It may not be suitable for investors who wish to withdraw their capital from the Sub-Fund within a period of 4 years. Allianz Strategy Select 50 is aimed at investors with basic knowledge and/or experience of financial products. Prospective investors should be capable of bearing a financial loss and should not attach any importance to capital protection.

Other Provisions / Restrictions / Additional Information

- Shares of all Share Classes may only be acquired by Allianz SE and its subsidiaries.
- The minimum subscription amount for the investment in Shares in the Share Classes IT (EUR) and IT4 (EUR) (after deduction of any Sales Charge) is EUR 25 million. In certain cases, the Management Company has discretion to permit lower minimum investments.

Allianz Strategy Select 75

Investor Profile

Allianz Strategy Select 75 is aimed at investors who pursue the objective of general capital formation/asset optimisation. It may not be suitable for investors who wish to withdraw their capital from the Sub-Fund within a period of 4 years. Allianz Strategy Select 75 is aimed at investors with basic knowledge and/or experience of financial products. Prospective investors should be capable of bearing a financial loss and should not attach any importance to capital protection.

Other Provisions / Restrictions / Additional Information

- Shares of all Share Classes may only be acquired by Allianz SE and its subsidiaries.
- The minimum subscription amount for the investment in Shares in the Share Class IT (EUR) (after deduction of any Sales Charge) is EUR 25 million. In certain cases, the Management Company has discretion to permit lower minimum investments.

Allianz Strategy4Life 30

Investor Profile

Allianz Strategy4Life 30 is aimed at investors who pursue the objective of general capital formation/asset optimisation and/or above-average participation in price changes. It may not be suitable for investors who wish to withdraw their capital from the Sub-Fund within a period of 3 years. Allianz Strategy4Life 30 is aimed at investors with basic knowledge and/or experience of financial products. Prospective investors should be capable of bearing a financial loss and should not attach any importance to capital protection.

Other Provisions / Restrictions / Additional Information

- Shares of all Share Classes may only be acquired by Allianz SE and its subsidiaries.
- The minimum subscription amount for the investment in Shares of all types of I/IT share classes (after deduction of any Sales Charge) is EUR 25 million. In certain cases, the Management Company has discretion to permit lower minimum investments.

Allianz Strategy4Life 50

Investor Profile

Allianz Strategy4Life 50 is aimed at investors who pursue the objective of general capital formation/asset optimisation and/or above-average participation in price changes. It may not be suitable for investors who wish to withdraw their capital from the Sub-Fund within a period of 4 years. Allianz Strategy4Life 50 is aimed at investors with basic knowledge and/or experience of financial products. Prospective investors should be capable of bearing a financial loss and should not attach any importance to capital protection.

Other Provisions / Restrictions / Additional Information

- Shares of all Share Classes may only be acquired by Allianz SE and its subsidiaries.
- The minimum subscription amount for the investment in Shares of all types of I/IT share classes (after deduction of any Sales Charge) is EUR 25 million. In certain cases, the Management Company has discretion to permit lower minimum investments.

Allianz Strategy4Life 75

Investor Profile

Allianz Strategy4Life 75 is aimed at investors who pursue the objective of general capital formation/asset optimisation and/or above-average participation in price changes. It may not be suitable for investors who wish to withdraw their capital from the Sub-Fund within a period of 4 years. Allianz Strategy4Life 75 is aimed at investors with basic knowledge and/or experience of financial products. Prospective investors should be capable of bearing a financial loss and should not attach any importance to capital protection.

Other Provisions / Restrictions / Additional Information

- Shares of all Share Classes may only be acquired by Allianz SE and its subsidiaries.
- The minimum subscription amount for the investment in Shares of all types of I/IT share classes (after deduction of any Sales Charge) is EUR 25 million. In certain cases, the Management Company has discretion to permit lower minimum investments.

Allianz Strategy4Life Europe 40

Investor Profile

Allianz Strategy4Life Europe 40 is aimed at investors who pursue the objective of general capital formation/asset optimisation and/or above-average participation in price changes. It may not be suitable for investors who wish to withdraw their capital from the Sub-Fund within a period of 3 years. Allianz Strategy4Life Europe 40 is aimed at investors with basic knowledge and/or experience of financial products. Prospective investors should be capable of bearing a financial loss and should not attach any importance to capital protection.

Other Provisions / Restrictions / Additional Information

- Shares of all Share Classes may only be acquired by Allianz SE and its subsidiaries.
- The minimum subscription amount for the investment in Shares of all types of I/IT share classes (after deduction of any Sales Charge) is EUR 25 million. In certain cases, the Management Company has discretion to permit lower minimum investments.

Allianz Sustainable Health Evolution

Investor Profile

Allianz Sustainable Health Evolution is aimed at investors who pursue the objective of general capital formation/asset optimisation and/or above-average participation in price changes. It may not be suitable for investors who wish to withdraw their capital from the Sub-Fund within a period of 5 years. Allianz Sustainable Health Evolution is aimed at investors with basic knowledge and/or experience of financial products. Prospective investors should be capable of bearing a financial loss and should not attach any importance to capital protection.

Other Provisions / Restrictions / Additional Information

-

Allianz Sustainable Multi Asset 75

Investor Profile

Allianz Sustainable Multi Asset 75 is aimed at investors who pursue the objective of general capital formation/asset optimisation and/or above-average participation in price changes. It may not be suitable for investors who wish to withdraw their capital from the Sub-Fund within a period of 4 years. Allianz Sustainable Multi Asset 75 is aimed at investors with basic knowledge and/or experience of financial products. Prospective investors should be capable of bearing a financial loss and should not attach any importance to capital protection.

Other Provisions / Restrictions / Additional Information

-

Allianz Systematic Enhanced US Equity SRI

Investor Profile

Allianz Systematic Enhanced US Equity SRI is aimed at investors who pursue the objective of general capital formation/asset optimisation and/or above-average participation in price changes. It may not be suitable for investors who wish to withdraw their capital from the Sub-Fund within a period of 5 years. Allianz Systematic Enhanced US Equity SRI is aimed at investors with basic knowledge and/or experience of financial products. Prospective investors should be capable of bearing a financial loss and should not attach any importance to capital protection.

Other Provisions / Restrictions / Additional Information

- The minimum subscription amount for the investment in Shares of the Share Classes I2 (USD) and IT2 (USD) (after deduction of any Sales Charge) is USD 5 million. In certain cases, the Management Company has discretion to permit lower minimum investments.
- Shares of Share Classes P7, PT7, R7, RT7, W7 and WT7 are reserved for Commerzbank AG or its affiliates.
- The minimum subscription amount for the investment in Shares in Share Classes P7, PT7, R7, RT7, W7 and WT7 (after deduction of any Sales Charge) is USD 250 million or equivalent in other currencies. In certain cases, the Management Company has discretion to permit lower minimum investments.
- Shares of Share Classes WT8 may only be acquired by Apothekerversorgung Niedersachsen Einrichtung der Apothekerkammer Niedersachsen KdöR.

Allianz Target Maturity Euro Bond I

Investor Profile

Allianz Target Maturity Euro Bond I is aimed at investors who pursue the objective of general capital formation/asset optimisation and/or above-average participation in price changes. It may not be suitable for investors who wish to withdraw their capital from the Sub-Fund before the maturity date. Allianz Target Maturity Euro Bond I is aimed at investors with basic knowledge and/or experience of financial products. Prospective investors should be capable of bearing a financial loss and should not attach any importance to capital protection.

Other Provisions / Restrictions / Additional Information

- Share Class types A/AT, I/IT, P/PT and W/WT may contain the additional name "Allianz Rendite Plus I" which is placed prior to the Share Class type.
- The Management Company has the right - but is not obliged - to close the Sub-Fund or selected share classes for subscriptions after Sub-Fund's launch date. This closure for subscriptions might not necessarily rely on market conditions and can be decided on a discretionary basis by the Management Company.
- The Company may, for purposes of orderly settlement and equal treatment of the investors, suspend the redemption of shares two months prior to maturity date (provided if it is not a Dealing Day, the next Dealing Day). The Company will publish the liquidation proceeds per share at which the investors may cash in their share certificates on final maturity of the Sub-Fund at the Registrar and Transfer Agent and the Paying Agents. Unclaimed liquidation proceeds shall be deposited at the Caisse de Consignation and will be forfeited if not claimed within the statutory period.
- The Management Company has the right - but is not obliged - to stop the carbon intensity KPI in the last two months prior to the sub-fund's maturity, as the proceeds of maturing bonds may be re-invested in short-term money market/government bonds for which no carbon intensity data is/might be available.
- The term of the Sub-Fund is limited to the maturity date; however, the Sub-Fund may be liquidated by resolution of the Company at any time prior to that date or merged as a subfund being absorbed prior to that date. The Sub-Fund is also liquidated in the cases listed under Section III.5.
- Subject to any prior liquidation or merger of the Sub-Fund, the Company will begin to sell the Sub-Fund's assets two months prior to maturity date and sell all assets, collect receivables and settle liabilities by the maturity date.
- The Management Company may charge a Disinvestment Fee of up to 2 % of the Net Asset Value of the Sub-Fund or selected share classes. The Management Company has discretion to levy a lower Disinvestment Fee.
- The investment strategy of the Sub-Fund is similar to the investment strategy followed by other Sub-Funds of the Company. However, these Sub-Funds may differ from each other on several criteria such as, but not limited to, the initial subscription period, the launch date, the investment horizon or the applicable pricing.
- For all distributing share classes the Company targets to distribute an amount which will be determined individually. However, such amount will in no case exceed the amount distributable by applying the general distribution policy for Distribution Shares.

Allianz Target Maturity Euro Bond II

Investor Profile

Allianz Target Maturity Euro Bond II is aimed at investors who pursue the objective of general capital formation/asset optimisation and/or above-average participation in price changes. It may not be suitable for investors who wish to withdraw their capital from the Sub-Fund before the maturity date. Allianz Target Maturity Euro Bond II is aimed at investors with basic knowledge and/or experience of financial products. Prospective investors should be capable of bearing a financial loss and should not attach any importance to capital protection.

Other Provisions / Restrictions / Additional Information

- Share Class types A/AT, I/IT, P/PT and W/WT may contain the additional name "Allianz Rendite Plus II" which is placed prior to the Share Class type.
- A placement fee of up to 2.00% of Share Classes A2/AT2's, C6/CT6's and W6/WT6's initial Net Asset Value is levied at the launch date of Share Classes A2/AT2's, C6/CT6 and W6/WT6 and paid out in a single instalment within two month of the Share Classes A2/AT2's, C6/CT6's and W6/WT6 's launch date. This Placement Fee is then amortized over the terms of the Sub-Fund. The Management Company has discretion to levy a lower Placement Fee.
- An exit fee of up to 2.00% of Share Classes A2/AT 2's, C6/CT6's and W6/WT6's initial Net Asset Value is levied at the launch of Share Classes A2/AT2's, C6/CT6's and W6/WT6's. The exit fee will remain in the Share Classes A2/AT2's, C6/CT6's and W6/WT6's and is calculated as a fix amount per Share of Share Classes A2/AT2's, C6/CT6's and W6/WT6's. The amount will be reduced by up to 0.50% of the initial NAV at launch date on a semi-annual basis.
- The Management Company has the right - but is not obliged - to close the Sub-Fund or selected share classes for subscriptions after Sub-Fund's launch date. This closure for subscriptions might not necessarily rely on market conditions and can be decided on a discretionary basis by the Management Company.
- The Company may, for purposes of orderly settlement and equal treatment of the investors, suspend the redemption of shares two months prior to maturity date (provided if it is not a Dealing Day, the next Dealing Day). The Company will publish the liquidation proceeds per share at which the investors may cash in their share certificates on final maturity of the Sub-Fund at the Registrar and Transfer Agent and the Paying Agents. Unclaimed liquidation proceeds shall be deposited at the Caisse de Consignation and will be forfeited if not claimed within the statutory period.
- The Management Company has the right - but is not obliged - to stop the carbon intensity KPI in the last two months prior to the sub-fund's maturity, as the proceeds of maturing bonds may be re-invested in short-term money market/government bonds for which no carbon intensity data is/might be available.

- The term of the Sub-Fund is limited to the maturity date; however, the Sub-Fund may be liquidated by resolution of the Company at any time prior to that date or merged as a subfund being absorbed prior to that date. The Sub-Fund is also liquidated in the cases listed under Section III.5.
- Subject to any prior liquidation or merger of the Sub-Fund, the Company will begin to sell the Sub-Fund's assets two months prior to maturity date and sell all assets, collect receivables and settle liabilities by the maturity date.
- The Management Company may charge a Disinvestment Fee of up to 2 % of the Net Asset Value of the Sub-Fund or selected share classes. The Management Company has discretion to levy a lower Disinvestment Fee.
- The investment strategy of the Sub-Fund is similar to the investment strategy followed by other Sub-Funds of the Company. However, these Sub-Funds may differ from each other on several criteria such as, but not limited to, the initial subscription period, the launch date, the investment horizon or the applicable pricing.
- For all distributing share classes the Company targets to distribute an amount which will be determined individually. However, such amount will in no case exceed the amount distributable by applying the general distribution policy for Distribution Shares.

Allianz Thematica

Investor Profile

Allianz Thematica is aimed at investors who pursue the objective of general capital formation/asset optimisation and/or above-average participation in price changes. It may not be suitable for investors who wish to withdraw their capital from the Sub-Fund within a period of 5 years. Allianz Thematica is aimed at investors with basic knowledge and/or experience of financial products. Prospective investors should be capable of bearing a financial loss and should not attach any importance to capital protection.

Other Provisions / Restrictions / Additional Information

- Share Class C2/CT2 and C3/CT3 will be closed after the end of the initial offer period except for reinvestment of distributions from Distribution Shares of Share Classes C2/CT2 and C3/CT3.
- A redemption fee of up to 2.00% of Share Class C2's and C3's Net Asset Value is levied within the first two years after the Share Class C2's or C3's launch date; thereafter no redemption fee will be charged.
- Shares of Share Class IT4 (EUR) may only be acquired by Allianz SE and its subsidiaries.
- The minimum subscription amount for the investment in Shares in Share Classes W7 and WT7 (after deduction of any Sales Charge) is EUR 50 million or equivalent in other currencies. In certain cases, the Management Company has discretion to permit lower minimum investments.
- Shares of Share Classes W7 and WT7 may only be acquired by Generali Group or its affiliates.

Allianz Total Return Asian Equity

Investor Profile

Allianz Total Return Asian Equity is aimed at investors who pursue the objective of general capital formation/asset optimisation and/or above-average participation in price changes. It may not be suitable for investors who wish to withdraw their capital from the Sub-Fund within a period of 5 years. Allianz Total Return Asian Equity is aimed at investors with basic knowledge and/or experience of financial products. Prospective investors should be capable of bearing a financial loss and should not attach any importance to capital protection.

Other Provisions / Restrictions / Additional Information

- The Subscription Price of the Shares must be received by the Company in cleared funds within three Valuation Days after the calculation of the Subscription Price. The Redemption Price will be paid out within three Valuation Days after calculation the Redemption Price.

Allianz Treasury Short Term Plus Euro

Investor Profile

Allianz Treasury Short Term Plus Euro is aimed at investors who pursue the objective of general capital formation/asset optimisation. It may not be suitable for investors who wish to withdraw their capital from the Sub-Fund within a period of 1 year. Allianz Treasury Short Term Plus Euro is aimed at investors with basic knowledge and/or experience of financial products. Prospective investors should be capable of bearing a financial loss and should not attach any importance to capital protection.

Other Provisions / Restrictions / Additional Information

- The minimum subscription amount for the investment in Shares of the Share Class I2 (EUR) and IT2 (EUR) (after deduction of any Sales Charge) is EUR 8 million. In certain cases, the Management Company has discretion to permit lower minimum investments.
- Shares of Share Classes I4 (EUR) and IT4 (EUR) may only be acquired by Allianz Nederland Levensverzekering and/or Allianz Benelux.
- Shares of Share Classes WT7 may only be acquired by investors who are clients of FINECO, or its affiliates.
- The minimum subscription amount for the investment in Shares of the Share Class WT7 (after deduction of any Sales Charge) is EUR 500 million. In certain cases, the Management Company has discretion to permit lower minimum investments.

Allianz Trend and Brands

Investor Profile

Allianz Trend and Brands is aimed at investors who pursue the objective of general capital formation/asset optimisation and/or above-average participation in price changes. It may not be suitable for investors who wish to withdraw their capital from the Sub-Fund within a period of 3 years. Allianz Trend and Brands is aimed at investors with basic knowledge and/or experience of financial products. Prospective investors should be capable of bearing a financial loss and should not attach any importance to capital protection.

Other Provisions / Restrictions / Additional Information

- A placement fee of up to 3.50% of Initial NAV at Share Classes C/CT's and W6/WT6's launch date is levied on the Share Classes C/CT and W6/WT6 and paid out in a single instalment after the end of the subscription period. This Placement Fee is then amortized over a 5-year period of the Sub-Fund. The Management Company has discretion to levy a lower Placement Fee.
- An exit fee of up to 3.50% of initial NAV at Share Classes C/CT's and W6/WT6's launch date will be applied after the end of the subscription period for share classes C/CT and W6/WT6. The exit fee will remain in the Share Classes C/CT and W6/WT6 and is calculated as a fixed amount per Share of Share Classes C/CT and W6/WT6. The amount will be reduced by up to 0.35% of the initial NAV at launch date on a semi-annual basis.
- The Management Company intends to limit subscriptions such that selected share classes will be closed for subscriptions after the end of a subscription period to be determined yet. This closure for subscriptions might not necessarily rely on market conditions and can be decided on a discretionary basis by the Management Company.
- The Management Company has the intention – but is legally not obliged – to liquidate or merge the Sub-Fund into another UCITS or UCI after 5 to 15 years after the Sub-Fund's launch date.

Allianz UK Government Bond

Investor Profile

Allianz UK Government Bond is aimed at investors who prioritise safety and/or pursue the objective of general capital formation/asset optimisation. It may not be suitable for investors who wish to withdraw their capital from the Sub-Fund within a period of 3 years. Allianz UK Government Bond is aimed at investors with basic knowledge and/or experience of financial products. Prospective investors should be capable of bearing a financial loss and should not attach any importance to capital protection.

Other Provisions / Restrictions / Additional Information

-

Allianz Unconstrained Multi Asset Strategy

Investor Profile

Allianz Unconstrained Multi Asset Strategy is aimed at investors who pursue the objective of general capital formation/asset optimisation and/or above-average participation in price changes. It may not be suitable for investors who wish to withdraw their capital from the Sub-Fund within a period of 5 years. Allianz Unconstrained Multi Asset Strategy is aimed at investors with basic knowledge and/or experience of financial products. Prospective investors should be capable of bearing a financial loss and should not attach any importance to capital protection.

Other Provisions / Restrictions / Additional Information

- Shares of Share Classes A13 and AT13 may be acquired using exclusive distribution via online brokerage platforms, self-directing clients or fee-based advisory ("Honorarberatung") only.
- Shares of Share Classes C and CT may be acquired for all other sales channels (distribution via traditional branch business) which are not included in the exclusive scope of Share Classes A13 and AT13.
- The minimum subscription amount for the investment in Shares of the Share Class I4 (H2-EUR) (after deduction of any Sales Charge) is EUR 12.5 million. In certain cases, the Management Company has discretion to permit lower minimum investments.

Allianz US Equity Fund

Investor Profile

Allianz US Equity Fund is aimed at investors who pursue the objective of general capital formation/asset optimisation and/or above-average participation in price changes. It may not be suitable for investors who wish to withdraw their capital from the Sub-Fund within a period of 5 years. Allianz US Equity Fund is aimed at investors with basic knowledge and/or experience of financial products. Prospective investors should be capable of bearing a financial loss and should not attach any importance to capital protection.

Other Provisions / Restrictions / Additional Information

-

Allianz US Equity Plus

Investor Profile

Allianz US Equity Plus is aimed at investors who pursue the objective of general capital formation/asset optimisation and/or above-average participation in price changes. It may not be suitable for investors who wish to withdraw their capital from the Sub-Fund within a period of 5 years. Allianz US Equity Plus is aimed at investors with basic knowledge and/or experience of financial products. Prospective investors should be capable of bearing a financial loss and should not attach any importance to capital protection.

Other Provisions / Restrictions / Additional Information

-

Allianz US Equity powered by Artificial Intelligence

Investor Profile

Allianz US Equity powered by Artificial Intelligence is aimed at investors who pursue the objective of general capital formation/asset optimisation and/or above-average participation in price changes. It may not be suitable for investors who wish to withdraw their capital from the Sub-Fund within a period of 5 years. Allianz US Equity powered by Artificial Intelligence is aimed at investors with basic knowledge and/or experience of financial products. Prospective investors should be capable of bearing a financial loss and should not attach any importance to capital protection.

Other Provisions / Restrictions / Additional Information

-

Allianz US High Yield

Investor Profile

Allianz US High Yield is aimed at investors who pursue the objective of general capital formation/asset optimisation. It may not be suitable for investors who wish to withdraw their capital from the Sub-Fund within a period of 4 years. Allianz US High Yield is aimed at investors with basic knowledge and/or experience of financial products. Prospective investors should be capable of bearing a financial loss and should not attach any importance to capital protection.

Other Provisions / Restrictions / Additional Information

- Shares of Share Class IT8 (H2-EUR) may only be acquired for clients domiciled in Italy which have signed a discretionary investment management agreement with the Management Company.
- For the share class WQ (H2-EUR) the Company targets to distribute an amount which will be determined each quarter individually. It is envisaged that the net performance of the share class of the previous quarter will be fully or partially distributed even if such distribution would require to distribute unrealized capital gains and/or capital. The amount will in no case exceed the amount distributable by applying the current general distribution policy for Distribution Shares. The net performance will be calculated as the difference between the NAV of the share class at the beginning and at the end of the previous quarter. If the NAV at the end of the previous quarter will fall below the NAV at the beginning of the previous quarter, no distribution is envisaged.

Allianz US Investment Grade Credit

Investor Profile

The Allianz US Investment Grade Credit is aimed at investors who pursue the objective of general capital formation/asset optimisation. It may not be suitable for investors who wish to withdraw their capital from the Sub-Fund within a period of 5 years. The Allianz US Investment Grade Credit is aimed at investors with basic knowledge and/or experience of financial products. Prospective investors should be capable of bearing a financial loss and should not attach any importance to capital protection.

Other Provisions / Restrictions / Additional Information

-

Allianz US Large Cap Value

Investor Profile

The Allianz US Large Cap Value is aimed at investors who pursue the objective of general capital formation/asset optimisation and/or above-average participation in price changes. It may not be suitable for investors who wish to withdraw their capital from the fund within a period of 5 years. The Allianz US Large Cap Value is aimed at investors with basic knowledge and/or experience of financial products. Prospective investors should be capable of bearing a financial loss and should not attach any importance to capital protection.

Other Provisions / Restrictions / Additional Information

-

Allianz US Short Duration High Income Bond

Investor Profile

Allianz US Short Duration High Income Bond is aimed at investors who pursue the objective of general capital formation/asset optimisation. It may not be suitable for investors who wish to withdraw their capital from the Sub-Fund within a period of 3 years. Allianz US Short Duration High Income Bond is aimed at investors with basic knowledge and/or experience of financial products. Prospective investors should be capable of bearing a financial loss and should not attach any importance to capital protection.

Other Provisions / Restrictions / Additional Information

-

Allianz Volatility Strategy Fund

Investor Profile

Allianz Volatility Strategy Fund is aimed at investors who pursue the objective of general capital formation/asset optimisation and/or above-average participation in price changes. It may not be suitable for investors who wish to withdraw their capital from the Sub-Fund within a period of 5 years. Allianz Volatility Strategy Fund is aimed at investors with basic knowledge and/or experience of financial products. Prospective investors should be capable of bearing a financial loss and should not attach any importance to capital protection.

Other Provisions / Restrictions / Additional Information

- The minimum subscription amount for the investment in Shares in Share Classes P7 (EUR) and PT7 (EUR) (after deduction of any Sales Charge) is EUR 100,000. In certain cases, the Management Company has discretion to permit lower minimum investments.
- The minimum subscription amounts for the investment in Shares in Share Classes, P2, PT2 are CHF 100,000, CZK 1.5 million, DKK 500,000, EUR 50,000, JPY 10 million, GBP 50,000, HKD 500,000, HUF 12.5 million, NOK 400,000, PLN 200,000, SEK 500,000, SGD 100,000, USD 50,000. In certain cases, the Management Company has discretion to permit lower minimum investments.

IndexManagement Balance

Investor Profile

IndexManagement Balance is aimed at investors who prioritise safety and/or pursue the objective of general capital formation/asset optimisation. It may not be suitable for investors who wish to withdraw their capital from the Sub-Fund within a period of 3 years. IndexManagement Balance is aimed at investors with basic knowledge and/or experience of financial products. Prospective investors should be capable of bearing a financial loss and should not attach any importance to capital protection.

Other Provisions / Restrictions / Additional Information

-

IndexManagement Chance

Investor Profile

IndexManagement Chance is aimed at investors who pursue the objective of general capital formation/asset optimisation and/or above-average participation in price changes. It may not be suitable for investors who wish to withdraw their capital from the Sub-Fund within a period of 4 years. IndexManagement Chance is aimed at investors with basic knowledge and/or experience of financial products. Prospective investors should be capable of bearing a financial loss and should not attach any importance to capital protection.

Other Provisions / Restrictions / Additional Information

-

IndexManagement Substanz

Investor Profile

IndexManagement Substanz is aimed at investors who prioritise safety and/or pursue the objective of general capital formation/asset optimisation. It may not be suitable for investors who wish to withdraw their capital from the Sub-Fund within a period of 3 years. IndexManagement Substanz is aimed at investors with basic knowledge and/or experience of financial products. Prospective investors should be capable of bearing a financial loss and should not attach any importance to capital protection.

Other Provisions / Restrictions / Additional Information

-

IndexManagement Wachstum

Investor Profile

IndexManagement Wachstum is aimed at investors who pursue the objective of general capital formation/asset optimisation and/or above-average participation in price changes. It may not be suitable for investors who wish to withdraw their capital from the Sub-Fund within a period of 4 years. IndexManagement Wachstum is aimed at investors with basic knowledge and/or experience of financial products. Prospective investors should be capable of bearing a financial loss and should not attach any importance to capital protection.

Other Provisions / Restrictions / Additional Information

-

Appendix 7

Proportions of a Sub-Fund's Net Asset Value Subject to Securities Financing Transactions

The following maximum and expected proportion of the Net Asset Value apply to all Sub-Funds that can be subject to TRS/CFDs. Sub-Funds not listed below are at current not subject to TRS/CFDs and do not intend to make use of TRS/CFDs.

Sub-Fund Name	TRS and CFDS (summed up) Expected/Maximum Proportion of NAV (%)	Rationale for Usage of Securities Financing Transactions
Allianz Better World Defensive	20/50	The Sub-Fund uses TRS mainly to gain long or short exposure to certain asset classes in various situations e.g., where exposure to the asset is core meeting the stated investment objectives. In addition, TRS might also be used in e.g., situations where access to sustainability-oriented indices via securities is either not possible or not possible to a sufficient extent and therefore TRS are used for gaining more efficient exposure.
Allianz Better World Dynamic	20/50	The Sub-Fund uses TRS mainly to gain long or short exposure to certain asset classes in various situations e.g., where exposure to the asset is core meeting the stated investment objectives. In addition, TRS might also be used in e.g., situations where access to sustainability-oriented indices via securities is either not possible or not possible to a sufficient extent and therefore TRS are used for gaining more efficient exposure.
Allianz Better World Moderate	20/50	The Sub-Fund uses TRS mainly to gain long or short exposure to certain asset classes in various situations e.g., where exposure to the asset is core meeting the stated investment objectives. In addition, TRS might also be used in e.g., situations where access to sustainability-oriented indices via securities is either not possible or not possible to a sufficient extent and therefore TRS are used for gaining more efficient exposure.
Allianz Dynamic Allocation Plus Equity	100/200	The Sub-Fund uses TRS to gain long or short exposure to certain asset classes in an efficient manner with aim of enhancing the return profile or managing risk. In addition, TRS might also be used in e.g., situations where access to the underlyings via securities is either not possible or not possible to a sufficient extent.
Allianz Dynamic Commodities	150/300	The Sub-Fund uses TRS on commodities to gain exposure to commodity markets in an efficient manner with the aim of enhancing the return profile or managing risk. Sub-Fund's gross exposure to TRS may be therefore large without increasing the risk profile of the Sub-Fund in general.
Allianz Dynamic Multi Asset Strategy SRI 15	10/30	The Sub-Fund uses TRS mainly to gain long or short exposure to certain asset classes in various situations e.g., where exposure to the asset is core meeting the stated investment objectives. In addition, TRS might also be used in e.g., situations where access to specific opportunistic and/or thematic investments via securities is either not possible or not possible to a sufficient extent and therefore TRS are used for gaining more efficient exposure.
Allianz Dynamic Multi Asset Strategy SRI 50	10/30	The Sub-Fund uses TRS mainly to gain long or short exposure to certain asset classes in various situations e.g., where exposure to the asset is core meeting the stated investment objectives. In addition, TRS might also be used in e.g., situations where access to specific opportunistic and/or thematic investments via securities is either not possible or not possible to a sufficient extent and therefore TRS are used for gaining more efficient exposure.
Allianz Dynamic Multi Asset Strategy SRI 75	10/30	The Sub-Fund uses TRS mainly to gain long or short exposure to certain asset classes in various situations e.g., where exposure to the asset is core meeting the stated investment objectives. In addition, TRS might also be used in e.g., situations where access to specific opportunistic and/or thematic investments via securities is either not possible or not possible to a sufficient extent and therefore TRS are used for gaining more efficient exposure.
Allianz Global Multi Asset Sustainability Balanced	50/120	The Sub-Fund uses TRS to gain long or short exposure to certain asset classes in an efficient manner with aim of enhancing the return profile or managing risk. In addition, TRS might also be used in e.g., situations where access to the underlyings via securities is either not possible or not possible to a sufficient extent.

Sub-Fund Name	TRS and CFDs (summed up) Expected/Maximum Proportion of NAV (%)	Rationale for Usage of Securities Financing Transactions
Allianz Global Multi Asset Sustainability Conservative	50/120	The Sub-Fund uses TRS to gain long or short exposure to certain asset classes in an efficient manner with aim of enhancing the return profile or managing risk. In addition, TRS might also be used in e.g., situations where access to the underlyings via securities is either not possible or not possible to a sufficient extent.
Allianz Global Multi Asset Sustainability Growth	75/150	The Sub-Fund uses TRS to gain long or short exposure to certain asset classes in an efficient manner with aim of enhancing the return profile or managing risk. In addition, TRS might also be used in e.g., situations where access to the underlyings via securities is either not possible or not possible to a sufficient extent.
Allianz Multi Asset Long / Short	50/140	The Sub-Fund uses TRS to gain long or short exposure to certain asset classes in an efficient manner with aim of enhancing the return profile or managing risk. In addition, TRS might also be used in e.g., situations where access to the underlyings via securities is either not possible or not possible to a sufficient extent.
Allianz Multi Asset Opportunities	10/75	The Sub-Fund uses TRS on commodities which can provide additional diversification and income sources for Sub-Fund's portfolio. TRS may be used to gain exposure to assets in an efficient manner with aim of enhancing the return profile or managing risk. TRS on further underlyings might also be used in e.g., situations where access to the underlying via securities is either not possible or not possible to a sufficient extent and therefore TRS are used for gaining more efficient exposure.
Allianz Multi Asset Risk Premia	150/300	The Sub-Fund uses TRS to gain long or short exposure to certain asset classes in an efficient manner with aim of enhancing the return profile or managing risk. In addition, TRS might also be used in e.g., situations where access to the underlyings via securities is either not possible or not possible to a sufficient extent.
Allianz Sustainable Multi Asset 75	20/50	The Sub-Fund uses TRS mainly to gain long or short exposure to certain asset classes in various situations e.g., where exposure to the asset is core meeting the stated investment objectives. In addition, TRS might also be used in e.g., situations where access to specific opportunistic and/or thematic investments via securities is either not possible or not possible to a sufficient extent and therefore TRS are used for gaining more efficient exposure.
Allianz Unconstrained Multi Asset Strategy	30/75	The Sub-Fund uses TRS on commodities which can provide additional diversification and income sources for Sub-Fund's portfolio. TRS may be used to gain exposure to assets in an efficient manner with aim of enhancing the return profile or managing risk. TRS on further underlyings might also be used in e.g., situations where access to the underlying via securities is either not possible or not possible to a sufficient extent and therefore TRS are used for gaining more efficient exposure.

Appendix 8

Other Investment Funds Managed by the Management Company

As at the date of the Prospectus the Management Company managed undertakings for collective investment in transferable securities (UCITS) or other undertakings for collective investment (UCI) established in Luxembourg either in the legal form as “fonds communs de placement en valeurs mobilières” (FCP) or as Société d’Investissement à Capital Variable (SICAV) as defined in the Law.

The Management Company managed as well undertakings for collective investment situated in Luxembourg as specialised investment fund according to the Luxembourg Law of 13 February 2007 relating to specialised investment funds and undertakings for collective investment situated in Luxembourg as reserved alternative investment funds according to the Luxembourg Law of 23 July 2016 relating to reserved alternative investment funds, each as amended from time to time.

The Management Company managed as well undertakings for collective investment in transferable securities (UCITS) or other undertakings for collective investment (UCI) established in France, Germany and Italy according to the corresponding domestic jurisdiction.

A list of all Funds and Share Classes which are available for public distribution in your home country may be obtained, free of charge upon request, at the registered office of the Company, from the Management Company or from the website <https://regulatory.allianzgi.com>.

Appendix 9

Benchmark Regulation & ESMA Register

EU administrators and administrators of third country benchmarks if the benchmark is mentioned in Appendix 1, Part B, and/or in Appendix 2, Part B and/or in Appendix 4 of this Prospectus are listed in the overview below.

Benchmark Administrator	EU / European Economic Area Status (as at the date of this Prospectus)
Bank of England	Exempted according to Article 2 (2) of the Benchmark Regulation
Bloomberg Index Services Limited	Authorisation under Article 34 of the Benchmark Regulation
European Central Bank (ECB)	Exempted according to Article 2 (2) of the Benchmark Regulation
European Money Markets Institute	Authorisation under Article 34 of the Benchmark Regulation
FTSE International Limited	Authorisation under Article 34 of the Benchmark Regulation
ICE Benchmark Administration Limited	Authorisation under Article 34 of the Benchmark Regulation
IHS Markit Benchmark Administration Limited	Authorisation under Article 34 of the Benchmark Regulation
Indonesia Stock Exchange (IDX)	Transitional period applies for third country benchmarks that are not listed in the ESMA Register.
J.P. Morgan Securities PLC	Registration under Article 34 of the Benchmark Regulation
JPX Market Innovation & Research, Inc.	Recognition under Article 32 of the Benchmark Regulation
MSCI Limited	Authorisation under Article 34 of the Benchmark Regulation
Nasdaq Copenhagen A/S	Registration under Article 34 of the Benchmark Regulation
Refinitiv Benchmark Services (UK) Limited	Registration under Article 34 of the Benchmark Regulation
S&P Dow Jones Indices LLC	Endorsement under Article 33 of the Benchmark Regulation
STOXX Ltd.	Recognition under Article 32 of the Benchmark Regulation
US Federal Reserve Bank	Exempted according to Article 2 (2) of the Benchmark Regulation

The Management Company will monitor the ESMA Register and, if there are any changes, this information will be updated in the Prospectus at the next opportunity.

Appendix 10

Sub-Funds managed in accordance with the Sustainability-related Disclosure Regulation and specific information to be disclosed in accordance with the Taxonomy Regulation

The investments of a Sub-Fund may basically consist of assets and/or instruments as mentioned in the "General Investment Principles", whereby there may also be additional restrictions to be found in the Sub-Fund's specific Asset Class Principles and in the Sub-Fund's individual investment objectives and investment restrictions as described in Appendix 1, Part B.

Sub-Fund Name	Sub-Fund fulfils only transparency requirements according to SFDR Article 6	Sub-Fund is managed in accordance with SFDR Article 8 (1)	Sub-Fund is managed in accordance with SFDR Article 9 (1)	Minimum of Sustainable Investments	Minimum of Taxonomy aligned Investments	Considerations of principal adverse impacts
Allianz ActiveInvest Balanced	-	✓	-	10.00 %	0.01 %	✓
Allianz ActiveInvest Defensive	-	✓	-	10.00 %	0.01 %	✓
Allianz ActiveInvest Dynamic	-	✓	-	10.00 %	0.01 %	✓
Allianz Advanced Fixed Income Euro	-	✓	-	2.00 %	0.01 %	✓
Allianz Advanced Fixed Income Global	-	✓	-	2.00 %	0.01 %	✓
Allianz Advanced Fixed Income Global Aggregate	-	✓	-	2.00 %	0.01 %	✓
Allianz Advanced Fixed Income Short Duration	-	✓	-	10.00 %	0.01 %	✓
Allianz All China Equity	-	✓	-	5.00 %	0.00 %	✓
Allianz Alternative Investment Strategies	✓	-	-	-	-	-
Allianz American Income	✓	-	-	-	-	-
Allianz Asian Multi Income Plus	✓	-	-	-	-	-
Allianz Asian Small Cap Equity	✓	-	-	-	-	-
Allianz Best Ideas 2025	✓	-	-	-	-	-
Allianz Best of Managers	✓	-	-	-	-	-
Allianz Best Styles Euroland Equity	✓	-	-	-	-	-
Allianz Best Styles Europe Equity	✓	-	-	-	-	-
Allianz Best Styles Europe Equity SRI	-	✓	-	30.00 %	0.01 %	✓
Allianz Best Styles Global AC Equity	✓	-	-	-	-	-
Allianz Best Styles Global Equity	✓	-	-	-	-	-
Allianz Best Styles Global Equity SRI	-	✓	-	20.00 %	0.01 %	✓
Allianz Best Styles Pacific Equity	✓	-	-	-	-	-
Allianz Best Styles US Equity	-	✓	-	15.00 %	0.01 %	✓

Sub-Fund Name	Sub-Fund fulfils only transparency requirements according to SFDR Article 6	Sub-Fund is managed in accordance with SFDR Article 8 (1)	Sub-Fund is managed in accordance with SFDR Article 9 (1)	Minimum of Sustainable Investments	Minimum of Taxonomy aligned Investments	Considerations of principal adverse impacts
Allianz Better World Defensive	-	-	✓	80 %	0.01 %	✓
Allianz Better World Dynamic	-	-	✓	80 %	0.01 %	✓
Allianz Better World Moderate	-	-	✓	80 %	0.01 %	✓
Allianz Blockchain Opportunities	✓	-	-	-	-	-
Allianz Capital Plus	-	✓	-	1.50 %	0.01 %	✓
Allianz Capital Plus Global	-	✓	-	1.50 %	0.01 %	✓
Allianz China A Opportunities	-	✓	-	5.00 %	0.00 %	✓
Allianz China A-Shares	-	✓	-	5.00 %	0.00 %	✓
Allianz China Equity	-	✓	-	2.00 %	0.00 %	✓
Allianz China Future Technologies	✓	-	-	-	-	-
Allianz China Healthy Living	✓	-	-	-	-	-
Allianz China Multi Income Plus	✓	-	-	-	-	-
Allianz China Strategic Bond	✓	-	-	-	-	-
Allianz China Thematica	-	✓	-	5.00 %	0.00 %	✓
Allianz Clean Planet	-	✓	-	> 50 %	0.00 %	✓
Allianz Climate Transition	-	✓	-	15.00 %	0.01 %	✓
Allianz Convertible Bond	-	✓	-	0.00 %	0.00 %	✓
Allianz Coupon Select Plus V	✓	-	-	-	-	-
Allianz Coupon Select Plus VI	✓	-	-	-	-	-
Allianz Credit Opportunities	✓	-	-	-	-	-
Allianz Credit Opportunities Plus	✓	-	-	-	-	-
Allianz Cyber Security	-	✓	-	2.00 %	0.00 %	✓
Allianz Dynamic Allocation Plus Equity	✓	-	-	-	-	-
Allianz Dynamic Asian High Yield Bond	✓	-	-	-	-	-
Allianz Dynamic Commodities	✓	-	-	-	-	-
Allianz Dynamic Multi Asset Strategy SRI 15	-	✓	-	1.00 %	0.01 %	✓
Allianz Dynamic Multi Asset Strategy SRI 50	-	✓	-	3.00 %	0.01 %	✓
Allianz Dynamic Multi Asset Strategy SRI 75	-	✓	-	5.00 %	0.01 %	✓
Allianz Emerging Asia Equity	✓	-	-	-	-	-
Allianz Emerging Europe Equity	✓	-	-	-	-	-
Allianz Emerging Markets Equity	✓	-	-	-	-	-
Allianz Emerging Markets Equity Opportunities	✓	-	-	-	-	-

Sub-Fund Name	Sub-Fund fulfils only transparency requirements according to SFDR Article 6	Sub-Fund is managed in accordance with SFDR Article 8 (1)	Sub-Fund is managed in accordance with SFDR Article 9 (1)	Minimum of Sustainable Investments	Minimum of Taxonomy aligned Investments	Considerations of principal adverse impacts
Allianz Emerging Markets Equity SRI	-	✓	-	5.00 %	0.01 %	✓
Allianz Emerging Markets Multi Asset Income	✓	-	-	-	-	-
Allianz Emerging Markets Select Bond	✓	-	-	-	-	-
Allianz Emerging Markets Short Duration Bond	✓	-	-	-	-	-
Allianz Emerging Markets Sovereign Bond	✓	-	-	-	-	-
Allianz Emerging Markets SRI Bond	-	✓	-	5.00 %	0.01 %	✓
Allianz Emerging Markets SRI Corporate Bond	-	✓	-	5.00 %	0.01 %	✓
Allianz Enhanced All China Equity	✓	-	-	-	-	-
Allianz Enhanced Short Term Euro	-	✓	-	2.50 %	0.01 %	✓
Allianz Euro Balanced	-	✓	-	7.50 %	0.01 %	✓
Allianz Euro Bond	-	✓	-	3.00 %	0.01 %	✓
Allianz Euro Bond Short Term 1-3 Plus	-	✓	-	1.00 %	0.01 %	✓
Allianz Euro Credit SRI	-	✓	-	15.00 %	0.01 %	✓
Allianz Euro Government Bond	-	✓	-	1.00 %	0.00 %	✓
Allianz Euro High Yield Bond	-	✓	-	5.00 %	0.01 %	✓
Allianz Euro High Yield Defensive	-	✓	-	20.00 %	0.01 %	✓
Allianz Euro Inflation-linked Bond	-	✓	-	0.00 %	0.00 %	✓
Allianz Euroland Equity Growth	-	✓	-	0.00 %	0.00 %	✓
Allianz Europe Equity Growth	-	✓	-	0.00 %	0.00 %	✓
Allianz Europe Equity Growth Select	-	✓	-	0.00 %	0.00 %	✓
Allianz Europe Equity powered by Artificial Intelligence	✓	-	-	-	-	-
Allianz Europe Equity SRI	-	✓	-	15.00 %	0.01 %	✓
Allianz Europe Equity Value	-	✓	-	10.00 %	0.01 %	✓
Allianz Europe Income and Growth	✓	-	-	-	-	-
Allianz Europe Mid Cap Equity	-	✓	-	30.00 %	0.01 %	✓
Allianz Europe Small and Micro Cap Equity	-	✓	-	20.00 %	0.01 %	✓
Allianz Europe Small Cap Equity	-	✓	-	20.00 %	0.01 %	✓
Allianz European Bond RC	✓	-	-	-	-	-
Allianz European Equity Dividend	-	✓	-	10.00 %	0.01 %	✓
Allianz Fixed Income Macro	✓	-	-	-	-	-

Sub-Fund Name	Sub-Fund fulfils only transparency requirements according to SFDR Article 6	Sub-Fund is managed in accordance with SFDR Article 8 (1)	Sub-Fund is managed in accordance with SFDR Article 9 (1)	Minimum of Sustainable Investments	Minimum of Taxonomy aligned Investments	Considerations of principal adverse impacts
Allianz Flexi Asia Bond	-	✓	-	2.50 %	0.01 %	✓
Allianz Floating Rate Notes Plus	-	✓	-	3.00 %	0.01 %	✓
Allianz Food Security	-	✓	-	> 50 %	0.00 %	✓
Allianz GEM Equity High Dividend	✓	-	-	-	-	-
Allianz German Equity	-	✓	-	15.00 %	0.01 %	✓
Allianz German Small and Micro Cap	✓	-	-	-	-	-
Allianz Global Aggregate Bond	✓	-	-	-	-	-
Allianz Global Artificial Intelligence	-	✓	-	10.00 %	0.01 %	✓
Allianz Global Capital Plus	-	✓	-	1.50 %	0.01 %	✓
Allianz Global Credit SRI	-	✓	-	10.00 %	0.01 %	✓
Allianz Global Diversified Dividend	-	✓	-	10.00 %	0.01 %	✓
Allianz Global Dividend	✓	-	-	-	-	-
Allianz Global Dynamic Multi Asset Income	✓	-	-	-	-	-
Allianz Global Emerging Markets Equity Dividend	✓	-	-	-	-	-
Allianz Global Equity Growth	-	✓	-	0.00 %	0.00 %	✓
Allianz Global Equity Insights	-	✓	-	10.00 %	0.01 %	✓
Allianz Global Equity powered by Artificial Intelligence	✓	-	-	-	-	-
Allianz Global Equity Unconstrained	-	✓	-	0.00 %	0.00 %	✓
Allianz Global Floating Rate Notes Plus	-	✓	-	5.00 %	0.01 %	✓
Allianz Global Government Bond	✓	-	-	-	-	-
Allianz Global High Yield	-	✓	-	5.00 %	0.01 %	✓
Allianz Global Hi-Tech Growth	-	✓	-	10.00 %	0.01 %	✓
Allianz Global Income	✓	-	-	-	-	-
Allianz Global Inflation-Linked Bond	-	✓	-	0.00 %	0.00 %	✓
Allianz Global Intelligent Cities Income	-	✓	-	10.00 %	0.01 %	✓
Allianz Global Metals and Mining	✓	-	-	-	-	-
Allianz Global Multi-Asset Credit	-	✓	-	10.00 %	0.01 %	✓
Allianz Global Multi-Asset Credit SRI	-	✓	-	5.00 %	0.01 %	✓
Allianz Global Multi Asset Sustainability Balanced	-	✓	-	3.00 %	0.01 %	✓
Allianz Global Multi Asset Sustainability Conservative	-	✓	-	1.50 %	0.01 %	✓
Allianz Global Multi Asset Sustainability Growth	-	✓	-	3.00 %	0.01 %	✓

Sub-Fund Name	Sub-Fund fulfils only transparency requirements according to SFDR Article 6	Sub-Fund is managed in accordance with SFDR Article 8 (1)	Sub-Fund is managed in accordance with SFDR Article 9 (1)	Minimum of Sustainable Investments	Minimum of Taxonomy aligned Investments	Considerations of principal adverse impacts
Allianz Global Opportunistic Bond	✓	-	-	-	-	-
Allianz Global Small Cap Equity	✓	-	-	-	-	-
Allianz Global Sustainability	-	✓	-	20.00 %	0.01 %	✓
Allianz Global Water	-	✓	-	> 50 %	0.00 %	✓
Allianz Green Bond	-	-	✓	80 %	0.01 %	✓
Allianz Green Future	-	✓	-	5.00 %	0.01 %	✓
Allianz Green Transition Bond	-	✓	-	20.00 %	0.01 %	✓
Allianz High Dividend Asia Pacific Equity	-	✓	-	2.00 %	0.00 %	✓
Allianz HKD Income	✓	-	-	-	-	-
Allianz Hong Kong Equity	✓	-	-	-	-	-
Allianz Income and Growth	✓	-	-	-	-	-
Allianz India Equity	✓	-	-	-	-	-
Allianz Indonesia Equity	✓	-	-	-	-	-
Allianz Japan Equity	-	✓	-	5.00 %	0.00 %	✓
Allianz Japan Smaller Companies Equity	✓	-	-	-	-	-
Allianz Laufzeitfonds	-	✓	-	5.00 %	0.01 %	✓
Allianz Little Dragons	✓	-	-	-	-	-
Allianz Metaverse	✓	-	-	-	-	-
Allianz Multi Asset Long / Short	✓	-	-	-	-	-
Allianz Multi Asset Opportunities	✓	-	-	-	-	-
Allianz Multi Asset Risk Premia	✓	-	-	-	-	-
Allianz Oriental Income	✓	-	-	-	-	-
Allianz Pet and Animal Wellbeing	-	✓	-	20.00 %	0.00 %	✓
Allianz Positive Change	-	✓	-	> 50 %	0.01 %	✓
Allianz Premium Champions	✓	-	-	-	-	-
Allianz Renminbi Fixed Income	✓	-	-	-	-	-
Allianz SDG Euro Credit	-	-	✓	80 %	0.01 %	✓
Allianz SDG Global Equity	-	✓	-	> 50 %	0.01 %	-
Allianz Select Income and Growth	✓	-	-	-	-	-
Allianz Selection Alternative	✓	-	-	-	-	-
Allianz Selection Fixed Income	✓	-	-	-	-	-
Allianz Selection Small and Mid Cap Equity	✓	-	-	-	-	-
Allianz Selective Global High Income	-	✓	-	5.00 %	0.01 %	✓
Allianz SGD Income	✓	-	-	-	-	-

Sub-Fund Name	Sub-Fund fulfils only transparency requirements according to SFDR Article 6	Sub-Fund is managed in accordance with SFDR Article 8 (1)	Sub-Fund is managed in accordance with SFDR Article 9 (1)	Minimum of Sustainable Investments	Minimum of Taxonomy aligned Investments	Considerations of principal adverse impacts
Allianz Short Duration Global Bond SRI	-	✓	-	10.00 %	0.01 %	✓
Allianz Smart Energy	-	✓	-	> 50 %	0.00 %	✓
Allianz Social Conviction Equity	-	✓	-	30.00 %	0.01 %	✓
Allianz Strategic Bond	✓	-	-	-	-	-
Allianz Strategy Select 30	✓	-	-	-	-	-
Allianz Strategy Select 50	✓	-	-	-	-	-
Allianz Strategy Select 75	✓	-	-	-	-	-
Allianz Strategy4Life 30	-	✓	-	0.00 %	0.00 %	✓
Allianz Strategy4Life 50	-	✓	-	0.00 %	0.00 %	✓
Allianz Strategy4Life 75	-	✓	-	0.00 %	0.00 %	✓
Allianz Strategy4Life Europe 40	-	✓	-	0.00 %	0.00 %	✓
Allianz Sustainable Health Evolution	-	✓	-	> 50 %	0.00 %	✓
Allianz Sustainable Multi Asset 75	-	✓	-	20.00 %	0.01 %	✓
Allianz Systematic Enhanced US Equity SRI	-	✓	-	20.00 %	0.01 %	✓
Allianz Target Maturity Euro Bond I	-	✓	-	5.00 %	0.01 %	✓
Allianz Target Maturity Euro Bond II	-	✓	-	5.00 %	0.01 %	✓
Allianz Thematica	-	✓	-	30.00 %	0.00 %	✓
Allianz Total Return Asian Equity	-	✓	-	2.00 %	0.00 %	✓
Allianz Treasury Short Term Plus Euro	-	✓	-	5.00 %	0.01 %	✓
Allianz Trend and Brands	✓	-	-	-	-	-
Allianz UK Government Bond	✓	-	-	-	-	-
Allianz Unconstrained Multi Asset Strategy	✓	-	-	-	-	-
Allianz US Equity Fund	✓	-	-	-	-	-
Allianz US Equity Plus	✓	-	-	-	-	-
Allianz US Equity powered by Artificial Intelligence	✓	-	-	-	-	-
Allianz US High Yield	✓	-	-	-	-	-
Allianz US Investment Grade Credit	✓	-	-	-	-	-
Allianz US Large Cap Value	✓	-	-	-	-	-
Allianz US Short Duration High Income Bond	-	✓	-	3.00 %	0.00 %	✓
Allianz Volatility Strategy Fund	✓	-	-	-	-	-
IndexManagement Balance	✓	-	-	-	-	-
IndexManagement Chance	✓	-	-	-	-	-

Sub-Fund Name	Sub-Fund fulfils only transparency requirements according to SFDR Article 6	Sub-Fund is managed in accordance with SFDR Article 8 (1)	Sub-Fund is managed in accordance with SFDR Article 9 (1)	Minimum of Sustainable Investments	Minimum of Taxonomy aligned Investments	Considerations of principal adverse impacts
IndexManagement Substanz	✓	-	-	-	-	-
IndexManagement Wachstum	✓	-	-	-	-	-

The Sub-Fund committing to a minimum percentage of investments that take into account the EU criteria for environmentally sustainable economic activities (i.e., Taxonomy-aligned) contributes through its investments to the following environmental objectives: (i) mitigation of climate change, and/or (ii) adaptation to climate change. The Technical Screening Criteria (“TSC”) for environmentally sustainable economic have not yet been fully developed (in particular for the other four environmental objectives determined by the Taxonomy Regulation). These detailed criteria will require the availability of multiple, specific data points regarding each investment, mainly relying on Company reported data. As at the date hereof, there is only limited reliable, timely and verifiable data available to be able to assess investments using the TSC. In, this context, the Management Company has selected an external Data and Research provider for determining the committed Taxonomy shares. The external Data and Research provider assesses corporate disclosures to evaluate if business activities of corporates meet the TSCs defined by the EU Commission. An additional Do No Significant Harm assessment on issuer is performed by the Management Company to evaluate the eligibility of the Taxonomy-aligned.

The “do no significant harm” principle applies only to those investments underlying the financial product that take into account the EU criteria for environmentally sustainable economic activities. The investments underlying the remaining portion of this financial product do not take into account the EU criteria for environmentally sustainable economic activities. Any other Sustainable Investments must also not significantly harm any environmental or social objectives.

SFDR Article 8 and Article 9 products, which have a high proportion of third-party target funds, do not mitigate PAI indicators, as the third-party target investment manager’s approach to exclusion criteria will likely be different than the Investment Managers` for instance regarding calculation methodology, underlying data and thresholds. Sub-Funds, which are not managed in accordance with SFDR Article 8 and Article 9 do not mitigate PAI indicators as they do not apply the sustainable minimum exclusion criteria.

Appendix 11

Important Information for Investors

Australia

This Prospectus is not a prospectus or product disclosure statement under the Corporations Act 2001 (Cth) (Corporations Act) and does not constitute a recommendation to acquire, an invitation to apply for, an offer to apply for or buy, an offer to arrange the issue or sale of, or an offer for issue or sale of, any securities in Australia except as set out below. The Company has not authorised nor taken any action to prepare or lodge with the Australian Securities & Investments Commission an Australian law compliant prospectus or product disclosure statement.

Accordingly, this Prospectus may not be issued or distributed in Australia and the Shares may not be offered, issued, sold or distributed in Australia by any person, under this Prospectus other than by way of or pursuant to an offer or invitation that does not need disclosure to investors under Part 6D.2 or Part 7.9 of the Corporations Act or otherwise.

This Prospectus does not constitute or involve a recommendation to acquire, an offer or invitation for issue or sale, an offer or invitation to arrange the issue or sale, or an issue or sale, of Shares to a 'retail client' (as defined in section 761G of the Corporations Act and applicable regulations) in Australia.

Austria

Note for Investors in the Republic of Austria

The sale of Shares of the Sub-Funds Allianz Advanced Fixed Income Global, Allianz Advanced Fixed Income Global Aggregate, Allianz Advanced Fixed Income Short Duration, Allianz All China Equity, Allianz Asian Small Cap Equity, Allianz Best Styles Europe Equity, Allianz Best Styles Global Equity, Allianz Best Styles US Equity, Allianz China A Opportunities, Allianz China A-Shares, Allianz China Equity, Allianz China Strategic Bond, Allianz Clean Planet, Allianz Convertible Bond, Allianz Credit Opportunities, Allianz Credit Opportunities Plus, Allianz Cyber Security, Allianz Dynamic Multi Asset Strategy SRI 15, Allianz Dynamic Multi Asset Strategy SRI 50, Allianz Dynamic Multi Asset Strategy SRI 75, Allianz Emerging Asia Equity, Allianz Emerging Europe Equity, Allianz Emerging Markets Equity, Allianz Emerging Markets Equity Opportunities, Allianz Emerging Markets Short Duration Bond, Allianz Emerging Markets Sovereign Bond, Allianz Enhanced All China Equity, Allianz Enhanced Short Term Euro, Allianz Euro Bond, Allianz Euro Credit SRI, Allianz Euro High Yield Bond, Allianz Euro High Yield Defensive, Allianz Euro Inflation-linked Bond, Allianz Euroland Equity Growth, Allianz Europe Equity Growth, Allianz Europe Equity Growth Select, Allianz Europe Equity SRI, Allianz Europe Equity Value, Allianz Europe Small Cap Equity, Allianz European Equity Dividend, Allianz Flexi Asia Bond, Allianz Floating Rate Notes Plus, Allianz Food Security, Allianz GEM Equity High Dividend, Allianz German Equity, Allianz Global Artificial Intelligence, Allianz Global Credit SRI, Allianz Global Diversified Dividend, Allianz Global Dividend, Allianz Global Emerging Markets Equity Dividend, Allianz Global Equity Insights, Allianz Global Equity Unconstrained, Allianz Global Floating Rate Notes Plus, Allianz Global Hi-Tech Growth, Allianz Global High Yield, Allianz Global Income, Allianz Global Metals and Mining, Allianz Global Multi-Asset Credit, Allianz Global Small Cap Equity, Allianz Global Sustainability, Allianz Global Water, Allianz Green Bond, Allianz Hong Kong Equity, Allianz Income and Growth, Allianz Japan Equity, Allianz Japan Smaller Companies Equity, Allianz Multi Asset Long / Short, Allianz Multi Asset Opportunities, Allianz Oriental Income, Allianz Pet and Animal Wellbeing, Allianz Positive Change, Allianz Renminbi Fixed Income, Allianz SDG Euro Credit, Allianz Selective Global High Income, Allianz Smart Energy, Allianz Strategic Bond, Allianz Sustainable Health Evolution, Allianz Thematica, Allianz Total Return Asian Equity, Allianz Treasury Short Term Plus Euro, Allianz Unconstrained Multi Asset Strategy, Allianz US Equity Fund, Allianz US High Yield, Allianz US Investment Grade Credit and Allianz US Short Duration High Income Bond in the Republic of Austria has been registered with the Finanzmarktaufsicht (Vienna) pursuant to section 140 InvFG. It is recommended to the investors to check before the acquisition of shares of the Sub-Funds if for the respective share class the required fiscal data are published via Oesterreichische Kontrollbank AG.

Brunei

This Prospectus relates to a foreign collective investment scheme which is not subject to any form of domestic regulation by the Autoriti Monetari Brunei Darussalam (the "Authority"). The Authority is not responsible for reviewing or verifying any prospectus or other documents in connection with this collective investment scheme. The Authority has not approved this Prospectus or any other associated documents nor taken any steps to verify the information set out in this Prospectus and is not responsible for it.

This Prospectus is addressed to a specific and selected class of investors who are an accredited investor, an expert investor or an institutional investor as defined in section 20 of the Securities Market Order, 2013, only, at their request so that they may consider an investment and subscription in the Shares. If you are not such a person, you may not receive, use or rely on this Prospectus. This Prospectus is not issued to the public or any class or section of the public in Brunei.

The Shares to which this Prospectus relates may be illiquid or subject to restrictions on their resale. Prospective purchasers should conduct their own due diligence on the Shares.

If you do not understand the contents of this Prospectus, you should consult a licensed financial adviser.

Denmark

Taxation of Danish Investors in Denmark

The description below is based on Danish tax law as in place on 2 December 2011.

The following summary does not purport to be a comprehensive description of all the tax considerations that may be relevant to a decision to acquire, hold or dispose of the shares, and does not purport to deal with the tax consequences applicable to all categories of investors, some of which (such as professional dealers in securities) may be subject to special rules. Potential

investors are under all circumstances strongly recommended to contact their own tax advisor to clarify the individual consequences of their investment, holding and disposal of the shares.

The Company makes no representations regarding the tax consequences of purchase, holding or disposal of the shares.

The Company is an investment company with variable capital under Luxembourg law and governed by the UCITS Directive and is, thus perceived as an investment company governed by Section 19 of the Danish Capital Gain Tax Act.

Individuals

Individuals investing in an investment company will be subject to tax on capital gains and losses on an unrealised basis (according to the mark-to-market principle).

Gains and losses are calculated as the annual increase or decrease in the value of the investor's shares in the investment company. The annual period used is the investment company's income year. If the Danish investor has only owned the shares for a part of the investment company's income year, the increase or decrease in the value of the shares in this partial period will be included in the Danish investor's income. For shares acquired by the investor during the income year, the purchase price will thus replace the value of the shares at the beginning of the investment company's income year, and for shares sold by the investor during the income year, the sales price will replace the value of the shares at the end of the investment company's income year.

If the Danish investor has not sold the shares in the investment company during the investment company's income year, the Danish investor shall include the gains or losses in his taxable income in the income year comprising the last day of the investment company's income year. If the Danish investor disposes the shares during the investment company's income year, the Danish investor must include the gains or losses in the taxable income in the year of disposal.

Gains and losses will normally be taxed as capital income at a rate of up to 47.5% in 2011 (the rate will be lowered to 45.5% in 2012, 43.5% in 2013 and 42% in 2014). If the individual is considered a professional dealer of shares in investment companies, gains and losses will normally be taxed as personal income at a rate of up to 56%.

Dividends are taxed as capital income at the rates described above.

Companies

Companies investing in an investment company will be subject to tax on capital gains and losses on an unrealised basis (according to the mark-to-market principle).

Gains and losses are calculated as the annual increase or decrease in the value of the investor's shares in the investment company. The annual period used is the investment company's income year. If the Danish investor has only owned the shares for a part of the investment company's income year, the increase or decrease in the value of the shares in this partial period will be included in the Danish investor's income. For shares acquired by the investor during the income year, the purchase price will thus replace the value of the shares at the beginning of the investment company's income year, and for shares sold by the investor during the income year, the sales price will replace the value of the shares at the end of the investment company's income year.

If the Danish investor has not sold the shares in the investment company during the investment company's income year, the Danish investor shall include the gains or losses in his taxable income in the income year comprising the last day of the investment company's income year. If the Danish investor disposes the shares during the investment company's income year, the Danish investor must include the gains or losses in the taxable income in the year of disposal.

Gains, losses and dividends will be taxed as ordinary corporate income at a rate of 25%.

Life Insurance Companies, Pension Funds and Deposits in Pension Accounts

Gains and losses are taxed on an unrealised basis (according to the mark-to-market principle). Under the Pension Savings Tax Regime gains, losses and dividends are taxed at a flat rate of 15%. The tax liability is imposed on the individual. Life insurance companies, pension funds etc. are, however, subject to taxation in certain situations as described in the Danish Act on Taxation of Pension Yield.

Life insurance companies are also liable to corporate tax and as such also subject to the tax rules described above under the heading "Companies".

The taxation under the corporate tax rules covers the part of the income, which is not related to pure life insurance activity. The Pension Savings Tax Regime, on the other hand, aims at taxing the yield paid out to the insured. Special rules ensure that the life insurance companies are not subject to double taxation.

Banks

Banks investing in investment companies are taxed on gains and losses on an unrealised basis (according to the mark-to-market principle) at a rate of 25%.

Dividends are taxable at a rate of 25 %.

Information the Company must publish

The Management Company is required to publish prices, major changes to the Company's Articles of Incorporation, key information document and Prospectus as well as information regarding mergers and closure in the appropriate durable medium in Luxembourg. This information will be made public in Denmark in the same way. The net asset value per Share of each share class as well as the subscription, redemption and conversion price per Share of each share class of the individual Sub-Funds may also be requested at the registered office of the Company and at the Management Company, the Paying and Information Agents, and the Distributors during business hours. The Share prices of each share class may also be obtained over the Internet at <https://regulatory.allianzgi.com> and Reuters.

Information the Company must provide to its investors

The Management Company is required to make the following information available to investors in Luxembourg: the Prospectus, key information document and annual and semi-annual reports for the Company. This information will always be available in

English to individual investors by request to the Company, the Management Company, the Distributors and the Paying and Information Agents. The key information document will be available in Danish by request to the Management Company.

Procedure in the event of Termination of a Fund

Should the Fund cease to be marketed in Denmark the investors will be informed thereof. In connection therewith the investors will be informed that any information and documents available upon written request to the Company, the Management Company, the Paying and Information Agents, and the Distributors will still be available to the investors in the same way. However, in connection therewith it will be stressed that information and documents will no longer be available in Danish. Furthermore, it will be ensured that the procedure for the payment of dividend and redemption proceeds will continue unchanged for the Danish investors unless the general procedure of the Fund is changed.

Taxation of Danish Investors

Local tax requirements for investors are subject to constant change and Investors under all circumstances are strongly recommended to contact their own tax advisor to clarify the individual consequences of their investment into, holding and disposal of any shares in Denmark.

France

Note for Investors Subject to Taxes in France

The investment policies for the Sub-Funds Allianz Euroland Equity Growth, Allianz German Equity, and Allianz German Small and Micro Cap are worded to ensure eligibility for the French Plan d'Épargne en Actions (PEA). Please refer to the specific information sheets for these Sub-Funds for further details.

The investment policies for the Sub-Fund Allianz Europe Small and Micro Cap Equity is worded to ensure eligibility for the French Plan d'Épargne en Actions destiné au financement des PME-ETI (PEA-PME). Please refer to the specific information sheets for this Sub-Fund for further details.

Germany

Note for Investors in the Federal Republic of Germany

No notification of public distribution in the Federal Republic of Germany in accordance with § 310 of the German Investment Code (KAGB) has been issued for the Allianz ActiveInvest Balanced, Allianz ActiveInvest Defensive, Allianz ActiveInvest Dynamic, Allianz American Income, Allianz Best Ideas 2025, Allianz Best of Managers, Allianz Blockchain Opportunities, Allianz China Healthy Living, Allianz Coupon Select Plus V, Allianz Coupon Select Plus VI, Allianz Emerging Markets Multi Asset Income, Allianz Euro Balanced, Allianz Euro Government Bond, Allianz Europe Small and Micro Cap Equity, Allianz Global Capital Plus, Allianz Global Multi-Asset Credit SRI, Allianz Green Future, Allianz Metaverse, Allianz Premium Champions, Allianz Select Income and Growth, Allianz Selection Alternative, Allianz Selection Fixed Income, Allianz Selection Small and Mid Cap Equity, Allianz SGD Income, Allianz Strategy Select 30, Allianz Strategy4Life 30, Allianz Strategy4Life 50, Allianz Strategy4Life 75, Allianz Sustainable Multi Asset 75, Allianz Trend and Brands and Allianz UK Government Bond. Therefore, Shares of these Sub-Funds may not be publicly distributed to investors in the Federal Republic of Germany.

All payments to Shareholders (proceeds from redemption, any distributions and other payments) can be made through the German Paying Agent listed in the "Directory". Applications for redemption and conversion may be submitted through the German Paying Agent.

With respect to sales in the Federal Republic of Germany, subscription prices, redemption prices and, if applicable, conversion prices are published on the website <https://de.allianzgi.com>. For selected Share Classes (e.g., Share Classes intended exclusively for institutional investors), the information may be published on one of the following websites: <https://regulatory.allianzgi.com> or <https://lu.allianzgi.com>.

Any announcements to investors are published in the Börsen-Zeitung (published in Frankfurt/Main) and online at the website <https://regulatory.allianzgi.com> or – if permitted by the Company's Articles of Incorporation, the Law and applicable Luxembourg and German regulations – solely online at the website <https://regulatory.allianzgi.com>.

In addition, in accordance with § 298 paragraph 2 of the German Investment Code a durable medium within the meaning of § 167 of the German Investment Code is used to inform investors in the Federal Republic of Germany in the following cases:

- Suspension of share redemption for a Sub-Fund,
- Termination of management of the Company or a Sub-Fund or dissolution of the Company or a Sub-Fund,
- Amendments to the terms and conditions that are not reconcilable with previous investment principles, affect important investor rights, or concern fees or expense reimbursements that can be taken from a Sub-Fund, including background information on the amendments and the rights of investors,
- In the event of a merger of a Sub-Fund with another Fund, the merger information required under Art. 43 of Council Directive 2009/65/EC,
- In the event of conversion of a Sub-Fund into a feeder fund or, if applicable, the changes to a master fund in the form of information required under Art. 64 of Council Directive 2009/65/EC.

The Prospectus, key information document, Articles of Incorporation, current annual and semi-annual reports, subscription, redemption and, if applicable, conversion prices, and the additional documentation listed under "Available Documentation" may be obtained in hard copy without charge from the Information Agent listed in the "Directory" and on the website <https://de.allianzgi.com>. For selected Share Classes (e.g., Share Classes intended exclusively for institutional investors), the information may be published on one of the following websites: <https://regulatory.allianzgi.com> or <https://lu.allianzgi.com>. The depositary agreement is available for inspection without charge at the offices of the Information Agent.

Neither the Management Company, the Depositary, the Registrar and Transfer Agent, the Distributor nor the Paying and Information Agents are liable for errors or omissions in the published prices.

Hong Kong

The Company is authorised as a collective investment scheme by the SFC. The SFC's authorisation is not a recommendation or endorsement of the Company of the Sub-Funds, nor does it guarantee their commercial merits or performance. It does not mean the Company is suitable for all investors nor is it an endorsement of its suitability for any particular investor or class of investors. Hong Kong offering documents of the Company are available for Hong Kong residents in both English and Chinese. Please note that not all of the Sub-Funds are available for distribution to the public in Hong Kong and investors should read the Hong Kong offering documents, which contain information for Hong Kong residents.

The Company's representative in Hong Kong is AllianzGI AP.

India

The Shares are not being offered to the Indian public for sale or subscription. The Shares are not registered and/or approved by the Securities and Exchange Board of India, the Reserve Bank of India or any other governmental/ regulatory authority in India. This Prospectus is not and should not be deemed to be a 'prospectus' as defined under the provisions of the companies act, 2013 (18 of 2013) and the same shall not be filed with any regulatory authority in India. The Company does not guarantee or promise to return any portion of the money invested towards the Shares by an investor and an investment in the Shares is subject to applicable risks associated with an investment in the Shares and shall not constitute a deposit within the meaning of the Banning of Unregulated Deposits Schemes Act, 2019. Pursuant to the Foreign Exchange Management Act, 1999 and the regulations issued there under, any investor resident in India may be required to obtain prior special permission of the Reserve Bank of India before making investments outside of India, including any investment in the Company. The Company has neither obtained any approval from the Reserve Bank of India or any other regulatory authority in India nor does it intend to do so.

Indonesia

This Prospectus does not constitute an offer to sell nor a solicitation to buy securities by the public in Indonesia.

Ireland

Taxation in Ireland

The following statements are provided in accordance with the requirements of Irish law and do not constitute tax advice. Any prospective investors and shareholders should consult their own independent tax advisers regarding their tax position in relation to the Company. The following statements are made on the basis of current Irish tax law and practice of the Revenue Commissioners in Ireland applicable to the holding and disposal of Shares in the Company where the shareholder regarded as holding a material interest in an offshore fund and is resident or ordinarily resident in Ireland or carrying on a trade in Ireland through a branch or agency in Ireland. Shareholders should note that this summary reflects the law and practice in force at the date of this document and may change in the future.

Scope of Irish Tax

Shareholders in the Company who are resident or ordinarily resident in Ireland or carrying on a trade in Ireland through a branch or agency in Ireland will be liable to tax in respect of income and gains arising on their Shares in accordance with the provisions of Chapter 4 Part 27 of the Taxes Consolidation Act, 1997. Accordingly, such shareholders will be obliged to comply with the requirements set out therein, together with any other provisions of Irish tax law which may apply to them.

Encashment Tax

Shareholders in the Company should note that any distributions made by a paying agent in Ireland on behalf of the Company or which are presented to, collected by, received by or otherwise realised by a bank or other person acting on behalf of the Shareholder in Ireland may be subject to encashment tax at the standard rate of income tax in Ireland. Encashment tax is creditable against the shareholder's final income tax liability.

Italy

In particular in Italy, the Shares may also be offered under Savings Plans by local distributors who offer this service in accordance with the terms and conditions which will be detailed in the Italian Subscription Form and relevant annex.

With regard to the SICAV's distributing share classes, either upon subscription or at a later date, the investor may request that part or all of the proceeds of the dividends distributed be allocated to a non-commercial entity or a non-profit organisation that is deemed 'socially useful' ("organizzazione non lucrativa di utilita' sociale") pursuant to Italian Legislative Decree no. 460 of 4 December 1997, as amended.

Liechtenstein

Note for Investors in Liechtenstein

1. Paying Agent in Liechtenstein

LGT Bank AG, Herrengasse 12, FL-9490 Vaduz, is Paying Agent in Liechtenstein for the shares distributed in Liechtenstein.

2. Place where the relevant documents may be obtained

The Prospectus, the key information document, the Articles of Incorporation as well as the annual and semi-annual reports may be obtained without charge from the Paying Agent in Liechtenstein.

3. Publications

The Net Asset Value of the Shares is published on <https://regulatory.allianzgi.com>.

4. Place of performance and jurisdiction

The place of performance and jurisdiction for Shares distributed in and from Liechtenstein is at the registered office of the Paying Agent in Liechtenstein.

Malaysia

No action has been, or will be, taken to comply with Malaysian laws for making available, offering for subscription or purchase, or issuing any invitation to subscribe for or purchase or sale of the Shares within Malaysia or to persons within Malaysia as the Shares are not intended by the issuer to be made available, or made the subject of any offer or invitation to subscribe or purchase, within Malaysia. Neither this Prospectus nor any document or other material in connection with the Shares should be distributed, caused to be distributed or circulated within Malaysia. No person should make available or make any invitation or offer or invitation to sell or purchase the Shares within Malaysia unless such person takes the necessary action to comply with Malaysian laws.

New Zealand

This Prospectus is not a product disclosure statement for the purposes of the Financial Markets Conduct Act 2013 (the FMCA) and does not contain all the information typically included in such offering documentation.

This offer of Shares does not constitute “regulated offer” for the purposes of the FMCA and, accordingly, there is neither a product disclosure statement nor a register entry available in respect of the offer. Shares may only be offered to “wholesale investors” in New Zealand in accordance with the laws of New Zealand, the FMCA, or in other circumstances where there is no contravention of the Financial Markets Conduct Regulations 2013

Philippines

Any person claiming an exemption under Section 10.1 of the Securities Regulation Code (“SRC”) (or the exempt transactions) must provide to any party to whom it offers or sells securities in reliance on such exemption a written disclosure containing the following information:

1. The specific provision of Section 10.1 of the SRC on which the exemption from registration is claimed; and
2. The following statement must be made in bold face, prominent type:

THE SECURITIES BEING OFFERED OR SOLD HEREIN HAVE NOT BEEN REGISTERED WITH THE SECURITIES AND EXCHANGE COMMISSION UNDER THE SECURITIES REGULATION CODE OF THE PHILIPPINES. ANY FUTURE OFFER OR SALE THEREOF IS SUBJECT TO REGISTRATION REQUIREMENTS UNDER THE CODE UNLESS SUCH OFFER OR SALE QUALIFIES AS AN EXEMPT TRANSACTION.

Where an offer or sale is not made pursuant to an exempt transaction under the SRC, by a purchase of the Shares, the investor will be deemed to acknowledge that the issue of, offer for subscription or purchase of, or invitation to subscribe for or purchase, such Shares was made outside the Philippines.

Poland

The Management Company has decided to cease distribution of Shares in the territory of the Republic of Poland to new individual investors, i.e., individual investors who were not Shareholders at the time as the subscription order was placed.

On the base of the Management Company’s right to reject, wholly or in part, any subscription application on any grounds, subscription applications for Shares of the sub-funds submitted by new individual investors (who were not Shareholders at the time the application was placed) will not be considered for execution.

Existing individual Shareholders and all potential Institutional Investors still have the possibility to purchase Shares in accordance with this prospectus.

Notwithstanding the foregoing, redemption applications for Shares of the Sub-Funds have not been restricted and the rules applicable to redemption of Shares as described in this prospectus apply.

Starting from 1 June 2022, orders for redemption of Shares may be submitted by sending the redemption form available on the website <https://regulatory.allianzgi.com/pl-PL/B2C/Poland-PL/Zawiadomienia-dla-Inwestorow>. Applications for redemption may be submitted by post at the address:

International Financial Data Services S.A. (IFDS)
DMC & Wire Room
Att.: AGI/AZZ Dealing Desk
49, avenue J.F. Kennedy
L-1855 Luxembourg
InvestorServicesAllianzGI@StateStreet.com

PRC

This Prospectus does not constitute a public offer of the Company, whether by sale or subscription, in the PRC. The Company is not being offered or sold directly or indirectly in the PRC to or for the benefit of, legal or natural persons of the PRC within the PRC.

Further, no legal or natural persons of the PRC within the PRC may directly or indirectly purchase any of the Company or any beneficial interest therein without obtaining all prior PRC’s governmental approvals that are required, whether statutorily or otherwise. Persons who come into possession of this document are required by the issuer and its representatives to observe these restrictions.

Singapore

Certain Sub-Funds are recognised schemes under the Securities and Futures Act, Chapter 289 of Singapore (the "SFA"). Certain Sub-Funds are restricted schemes under the Sixth Schedule to the Securities and Futures (Offers of Investments) (Collective Investment Schemes) Regulations, as may be amended from time to time. Please note that not all of the Sub-Funds are registered as recognised schemes and/or restricted schemes in Singapore and investors should read the offering documents of the respective schemes in Singapore for details.

The Singapore representative of the Company is AllianzGI Singapore.

Switzerland

Information for Investors in Switzerland

1. Representative and Paying Agent in Switzerland

BNP Paribas, Paris, Zurich Branch, Selnaustrasse 16, CH-8002 Zurich, is Representative and Paying Agent in Switzerland for the shares offered in Switzerland.

2. Place where the relevant documents may be obtained

The Prospectus, the key information document, the Articles of Incorporation as well as the annual and semi-annual reports may be obtained without charge from the Representative in Switzerland.

3. Publications

Publications in Switzerland are made on www.fundinfo.com. In Switzerland, Subscription and Redemption Prices together and/or the Net Asset Value (with the indication "commissions excluded") of the Shares are published daily on www.fundinfo.com.

4. Payment of retrocessions and rebates Retrocessions:

The Management Company and its agents may pay retrocessions as remuneration for distribution activity in respect of Shares in Switzerland. This remuneration may be deemed payment for the following services in particular:

- Setting up processes for subscribing, holding and safe custody of the units,
- Keeping a supply of marketing and legal documents, and issuing the said,
- Forwarding or providing access to legally required publications and other publications,
- Performing due diligence delegated by the Management Company in areas such as money laundering, ascertaining client needs and distribution restrictions,
- Operating and maintaining an electronic distribution and/or information platform,
- Clarifying and answering specific questions from investors pertaining to the investment product or the Management Company or the Sub-Investmentmanager,
- Drawing up fund research material,
- Central relationship management,
- Subscribing units/shares as a "nominee" for several clients as mandated by the Management Company,
- Training client advisors in collective investment schemes,
- Mandating and monitoring additional distributors,

Retrocessions are not deemed to be rebates even if they are ultimately passed on, in full or in part, to the investors.

Disclosure of the receipt of retrocessions is based on the applicable provisions of FinSA.

Rebates:

In the case of distribution activity in Switzerland, the Management Company and its agents may, upon request, pay rebates directly to investors. The purpose of rebates is to reduce the fees or costs incurred by the investor in question. Rebates are permitted provided that

- they are paid from fees received by the Management Company and therefore do not represent an additional charge on the fund assets,
- they are granted on the basis of objective criteria,
- all investors who meet these objective criteria and demand rebates are also granted these within the same timeframe and to the same extent.

The objective criteria for the granting of rebates by the Management Company are:

- the volume subscribed by the investor or the total volume they hold in the collective investment scheme or, where applicable, in the product range of the promoter,
- the amount of the fees generated by the investor,
- the investment behaviour shown by the investor (e.g., expected investment period);
- the investor's willingness to provide support in the launch phase of a collective investment scheme.

At the request of the investor, the Management Company must disclose the amounts of such rebates free of charge.

5. Place of performance and jurisdiction

In respect of the Shares offered in Switzerland, the place of performance is at the registered office of the Representative in Switzerland. The place of jurisdiction is at the registered office of the Representative in Switzerland or at the registered office or place of residence of the investor.

Taiwan

Certain Sub-Funds of the Company have been approved by the Financial Supervisory Commission (the "FSC"), or effectively registered with FSC, for public offering and sale through Allianz Global Investors Taiwan Limited ("AllianzGI Taiwan"), as the master agent in Taiwan and other distribution channels which have entered into the distribution agreements with AllianzGI Taiwan, in accordance with the Securities Investment Trust and Consulting Act, Regulations Governing the Offshore Funds, and other applicable laws and regulations. Full details of the Sub-Funds that are available for investment in Taiwan are set out in the offering documents for Taiwan (which is available in Chinese only).

With respect to certain Sub-Funds of the Company that have not been approved by the FSC, such Sub-Funds may not be offered in Taiwan, except to (i) outside Taiwan for purchase outside Taiwan by Taiwan resident investors, or (ii) to the offshore banking units (as defined in the Taiwan Offshore Banking Act) of Taiwan banks, the offshore securities units (as defined in the Taiwan Offshore Banking Act) of Taiwan securities firms or the offshore insurance units (as defined in the Taiwan Offshore Banking Act) of Taiwan insurance companies purchasing the sub-funds either for their proprietary account or for the accounts of their non-Taiwan clients or (iii) to other investors in Taiwan to the extent permitted under relevant Taiwan laws and regulations.

Thailand

The Prospectus has not been approved by the Securities and Exchange Commission which takes no responsibility for its contents. No offer to the public to purchase the Shares will be made in Thailand and this Prospectus is intended to be read by the addressee only and must not be passed to, issued to, or shown to the public generally.

United Arab Emirates (UAE)

For Unregistered Funds – for use in respect of unsolicited requests only for United Arab Emirates (excluding Dubai International Financial Centre and Abu Dhabi Global Market) residents only:

This Prospectus, and the information contained herein, does not constitute, and is not intended to constitute, a public offer of securities in the United Arab Emirates and accordingly should not be construed as such. The Shares are only being offered to a limited number of investors in the UAE who (a) are willing and able to conduct an independent investigation of the risks involved in an investment in such Shares, and (b) upon their specific request. The Shares have not been approved by or licensed or registered with the UAE Central Bank, the Securities and Commodities Authority or any other relevant licensing authorities or governmental agencies in the UAE. The Prospectus is for the use of the named addressee only, who has specifically requested it without a promotion effected by the Management Company, its promoters or the distributors of its units, and should not be given or shown to any other person (other than employees, agents or consultants in connection with the addressee's consideration thereof). No transaction will be concluded in the UAE and any enquiries regarding the Shares should be made to the Management Company.

For Unregistered Funds – for use in respect of the Qualified Investor Exemption only for United Arab Emirates (excluding Dubai International Financial Centre and Abu Dhabi Global Market) residents only:

This Prospectus, and the information contained herein, does not constitute, and is not intended to constitute, a public offer of securities in the United Arab Emirates ("UAE") and accordingly should not be construed as such. The Shares are only being offered to a limited number of exempt investors in the UAE who fall under one of the following categories of Exempt Qualified Investors unless the provisions of the Directors' Chairman Decision No. 9/R.M. of 2016 concerning the regulations on mutual funds and exemptions to the SCA Resolution No. 3 R.M. of 2017 regulating promotions and introductions do not apply: (1) an investor which is able to manage its investments on its own (unless such person wishes to be classified as a retail investor), namely: (a) the federal government, local governments, and governmental entities, institutions and authorities, or companies wholly-owned by any such entities; (b) foreign governments, their respective entities, institutions and authorities or companies wholly owned by any such entities; (c) international entities and organisations; (d) entities licensed by the Securities and Commodities Authority (the "SCA") or a regulatory authority that is an ordinary or associate member of the International Organisation of Securities Commissions (a "Counterpart Authority"); or (e) any legal person that meets, as at the date of its most recent financial statements, at least two of the following conditions: (i) it has a total assets or balance sheet of AED 75 million; (ii) it has a net revenues of AED 150 million; (iii) it has total net equities or paid capital of AED 7 million; or (2) a natural person licensed by the SCA or a Counterpart Authority to carry out any of the functions related to financial activities or services, (each an "Exempt Qualified Investor").

The Shares have not been approved by or licensed or registered with the UAE Central Bank, the SCA, the Dubai Financial Services Authority, the Financial Services Regulatory Authority or any other relevant licensing authorities or governmental agencies in the UAE (the "Authorities"). The Authorities assume no liability for any investment that the named addressee makes as an Exempt Qualified Investor. The Prospectus is for the use of the named addressee only and should not be given or shown to any other person (other than employees, agents or consultants in connection with the addressee's consideration thereof).

United Kingdom

Note for Investors in the United Kingdom

The names and addresses of the UK Distributor(s) and Facilities Agent in the United Kingdom are listed in the Directory.

Any purchaser and any Shareholder may partially or completely sell Shares by providing written instructions to the Facilities Agent in the United Kingdom.

The Subscription and Redemption Prices may be obtained from the Facilities Agent in the United Kingdom.

Complaints may be submitted to the Facilities Agent in the United Kingdom.

UK Reporting Status Shares

For United Kingdom tax purposes, the Board of Directors currently intends to apply in respect of each accounting period for certification of certain of its Share Classes in line with the reporting status regime. However, no guarantee can be given that such certification will be obtained.

The UK Retail Distribution Review (RDR)

Intermediaries that are regulated by the UK's Financial Conduct Authority (FCA) or are a UK branch of a regulated entity in a member state of the European Economic Area (EEA) are from 31 December 2012 subject to the FCA's RDR rules in relation to investment advice that they provide to retail clients.

In accordance with the RDR rules, any intermediary distributing funds who (i) is subject to these rules and (ii) who provides personal recommendations or advice to retail clients located in the UK, shall not be entitled to receive any commission from the fund provider in respect of any investment made after 31 December 2012 on behalf of, or related services provided to, such retail clients.

Any potential investor who is subject to the RDR rules and who provides personal recommendations or advice to retail clients located in the UK is therefore obliged to ensure that it only invests in appropriate share classes on behalf of its clients.

All variations of the Share Class P (GBP) do not pay an adviser commission.

The above summary does not purport to be a comprehensive description of all the considerations that may be relevant to an investor with regard to RDR. Potential investors are strongly recommended to contact their own legal advisers in this respect.

Available Documentation

The following documents are available at no charge at the UK Distributor and Facilities Agent during normal business hours on each Business Day:

- a) Articles of Incorporation of the Fund and any amendments thereto,
- b) the latest Prospectus,
- c) the latest key information documents,
- d) the latest annual and semi-annual reports

Temporary Marketing Permissions Regime

The Company and the following Sub-Funds Allianz Advanced Fixed Income Short Duration, Allianz All China Equity, Allianz American Income, Allianz Asian Multi Income Plus, Allianz Asian Small Cap Equity, Allianz Best Styles Euroland Equity, Allianz Best Styles Global Equity, Allianz Best Styles US Equity, Allianz China A-Shares, Allianz China Equity, Allianz China Future Technologies, Allianz China Multi Income Plus, Allianz China Strategic Bond, Allianz Climate Transition, Allianz Convertible Bond, Allianz Credit Opportunities, Allianz Dynamic Asian High Yield Bond, Allianz Dynamic Commodities, Allianz Emerging Asia Equity, Allianz Emerging Europe Equity, Allianz Emerging Markets Equity Opportunities, Allianz Emerging Markets Equity SRI, Allianz Emerging Markets Select Bond, Allianz Emerging Markets Short Duration Bond, Allianz Emerging Markets Sovereign Bond, Allianz Emerging Markets SRI Bond, Allianz Emerging Markets SRI Corporate Bond, Allianz Enhanced All China Equity, Allianz Euro Bond, Allianz Euro Credit SRI, Allianz Euro High Yield Bond, Allianz Euroland Equity Growth, Allianz Europe Equity Growth, Allianz Europe Equity Growth Select, Allianz Europe Equity SRI, Allianz Europe Mid Cap Equity, Allianz Europe Small Cap Equity, Allianz European Equity Dividend, Allianz Fixed Income Macro, Allianz Flexi Asia Bond, Allianz Food Security, Allianz GEM Equity High Dividend, Allianz German Equity, Allianz Global Artificial Intelligence, Allianz Global Credit SRI, Allianz Global Equity Insights, Allianz Global Equity Unconstrained, Allianz Global Floating Rate Notes Plus, Allianz Global High Yield, Allianz Global Hi-Tech Growth, Allianz Global Multi-Asset Credit, Allianz Global Multi-Asset Credit SRI, Allianz Global Opportunistic Bond, Allianz Global Small Cap Equity, Allianz Global Sustainability, Allianz Global Water, Allianz Green Bond, Allianz High Dividend Asia Pacific Equity, Allianz Hong Kong Equity, Allianz Income and Growth, Allianz India Equity, Allianz Indonesia Equity, Allianz Japan Equity, Allianz Japan Smaller Companies Equity, Allianz Little Dragons, Allianz Multi Asset Long / Short, Allianz Multi Asset Opportunities, Allianz Multi Asset Risk Premia, Allianz Oriental Income, Allianz Pet and Animal Wellbeing, Allianz Renminbi Fixed Income, Allianz Selective Global High Income, Allianz Short Duration Global Bond SRI, Allianz Strategic Bond, Allianz Thematica, Allianz Total Return Asian Equity, Allianz Treasury Short Term Plus Euro, Allianz Unconstrained Multi Asset Strategy, Allianz US Equity Fund, Allianz US High Yield, Allianz US Short Duration High Income Bond, and Allianz Volatility Strategy Fund (together "the Funds") have been established and are authorised as an EEA UCITS (in accordance with the EU UCITS Directive) in Luxembourg. The Funds have been notified to the Financial Conduct Authority of the UK (the "FCA") for the purposes of the temporary marketing permissions regime in the United Kingdom and therefore are considered to be a recognised collective investment scheme for the purposes of the Financial Services and Markets Act 2000 of the United Kingdom ("FSMA").

The distribution of this Prospectus and the offering of Shares in the United Kingdom may be restricted. Persons into whose possession this Prospectus comes are required by the Management Company to inform themselves about and to observe any such restrictions. This Prospectus does not constitute an offer or solicitation to any person to whom it is unlawful to make such offer or solicitation.

National Private Placement Regime

Allianz China A Opportunities, Allianz Clean Planet, Allianz Cyber Security, Allianz Global Intelligent Cities Income, Allianz Green Transition Bond, Allianz Positive Change, Allianz Smart Energy, Allianz Sustainable Health Evolution and Allianz UK Government Bond ("the Sub-funds")

This Prospectus may only be distributed and the Shares of these Sub-Funds may only be offered or placed in the United Kingdom to the extent that (1) these Sub-Funds are permitted to be marketed to professional investors in the United Kingdom in accordance with Alternative Investment Fund Managers Directive (Directive (2011/61/EU) (the "AIFMD") (including the delegated and implementing acts adopted under it) as implemented, retained, amended, extended, re-enacted or otherwise given effect in the United Kingdom at the end of the transitional period agreed between the European Union and the United Kingdom pursuant to the European Union (Withdrawal) Act 2018 and as amended or supplemented in the United Kingdom thereafter. This Prospectus is being issued in the United Kingdom by the Management Company to and/or is directed only at persons who are professional investors for the purposes of the Alternative Investment Fund Managers Regulations 2013, as amended, and is accordingly exempt from the financial promotion restriction in Section 21 of the Financial Services and Markets Act 2000 ("FSMA") in accordance with article 29(3) of the FSMA (Financial Promotions) Order 2005. The opportunity to invest in these Sub-Funds is only available to such persons in the United Kingdom and this Prospectus must not be relied or acted upon by any other persons in the United Kingdom.

Allianz Global Investors GmbH

Bockenheimer Landstrasse 42 – 44

DE-60323 Frankfurt/Main

Internet: <https://de.allianzgi.com>

E-Mail: info@allianzgi.de

Allianz Global Investors GmbH, acting through the Luxembourg Branch

6A, route de Trèves

LU-2633 Senningerberg

Internet: <https://lu.allianzgi.com>

E-mail: info-lux@allianzgi.com

Template pre-contractual disclosure for the financial products referred to in Article 8, paragraphs 1, 2 and 2a, of Regulation (EU) 2019/2088 and Article 6, first paragraph, of Regulation (EU) 2020/852

Product name:

Allianz ActiveInvest Balanced

Legal entity identifier: 529900NM5P2JVX9T0X69

Environmental and/or social characteristics

Sustainable investment means an investment in an economic activity that contributes to an environmental or social objective, provided that the investment does not significantly harm any environmental or social objective and that the investee companies follow good governance practices.

The **EU Taxonomy** is a classification system laid down in Regulation (EU) 2020/852, establishing a list of **environmentally sustainable economic activities**. That Regulation does not include a list of socially sustainable economic activities. Sustainable investments with an environmental objective might be aligned with the Taxonomy or not.

Does this financial product have a sustainable investment objective?	
Yes	No
<input type="checkbox"/> It will make a minimum of sustainable investments with an environmental objective: ___% <ul style="list-style-type: none"> <input type="checkbox"/> in economic activities that qualify as environmentally sustainable under the EU Taxonomy <input type="checkbox"/> in economic activities that do not qualify as environmentally sustainable under the EU Taxonomy 	<input checked="" type="checkbox"/> It promotes Environmental/Social (E/S) characteristics and while it does not have as its objective a sustainable investment, it will have a minimum proportion of 10.00% of sustainable investments <ul style="list-style-type: none"> <input checked="" type="checkbox"/> with an environmental objective in economic activities that qualify as environmentally sustainable under the EU Taxonomy <input checked="" type="checkbox"/> with an environmental objective in economic activities that do not qualify as environmentally sustainable under the EU Taxonomy <input checked="" type="checkbox"/> with a social objective
<input type="checkbox"/> It will make a minimum of sustainable investments with a social objective ___%	<input type="checkbox"/> It promotes E/S characteristics, but will not make any sustainable investments



What environmental and/or social characteristics are promoted by this financial product?

Allianz ActiveInvest Balanced (the "Sub-Fund") promotes a broad range of environmental and/or social characteristics. The Sub-Fund invests at least 70% of its assets following the "Multi Asset Sustainability Strategy" which includes, but is not limited to, various sustainability strategies of the management company and/or, invests in Green Bonds and/or Social Bonds, and/or Sustainability Bonds and/or SFDR Article 8 & 9 Target Funds ("SFDR Target Funds").

Depending on the sustainability strategy selected by the Investment Manager the promoted environmental and/or social characteristics could comprise environmental, social, human rights, governance, business behaviour factors or investments in companies providing solutions that create positive environmental and social outcomes.

In addition, sustainable minimum exclusion criteria apply.

No reference benchmark has been designated for the purpose of attaining the environmental and/or social characteristics promoted by the Sub-Fund.

- **What sustainability indicators are used to measure the attainment of each of the environmental or social characteristics promoted by this financial product?**

As part of the Multi Asset Sustainability Strategy the Investment Manager allocates at least 70% of Fund's assets in various sustainability approaches.

Sustainability indicators measure how the environmental or social characteristics promoted by the financial product are attained.

To measure the attainment of the environmental and/or social characteristics the following sustainability indicators are used and reported on, at the fiscal year end:

- The actual percentage of the Sub-Fund's assets invested in Green Bonds, and/or Social Bonds, and/or Sustainability Bonds and/or in SFDR Target Funds and/or in Equities and/or Debt Securities in accordance with the Multi Asset Sustainability Strategy.
- In case the Investment Manager decides to directly invest in Debt or Equity Securities as part of the Multi Asset Sustainability Strategy the adherence to the respective binding element will be reported.
- Confirmation that Principal Adverse Impacts (PAIs) of investment decisions on sustainability factors are considered through the application of exclusion criteria (with exception of cash, derivatives, external Target Funds and internal Target Funds not following a sustainability strategy).

● **What are the objectives of the sustainable investments that the financial product partially intends to make and how does the sustainable investment contribute to such objectives?**

Sustainable investments contribute to environmental and/or social objectives, for which the Investment Manager uses as reference frameworks, among others, the UN Sustainable Development Goals (SDGs), as well as the objectives of the EU Taxonomy:

1. Climate Change Mitigation
2. Climate Change Adaptation
3. Sustainable Use and Protection of Water and Marine Resources
4. Transition to a Circular Economy
5. Pollution Prevention and Control
6. Protection and Restoration of Biodiversity and Ecosystems

The assessment of the positive contribution to the environmental or social objectives is based on a proprietary framework which combines quantitative elements with qualitative inputs from internal research. The methodology applies first a quantitative breakdown of a securities issuer into its business activities. The qualitative element of the framework is an assessment if business activities contribute positively to an environmental or a social objective.

To calculate the positive contribution on the Sub-Fund level the revenue share of each issuer attributable to business activities contributing to environmental and/or social objectives is considered provided the issuer is satisfying the Do No Significant Harm ("DNSH") and Good Governance principles, and an asset-weighted aggregation is performed as a second step. Moreover, for certain types of securities, which finance specific projects contributing to environmental or social objectives the overall investment is considered to contribute to environmental and/or social objectives, but also for these a DNSH as well as a Good Governance check for issuers is performed.

● **How do the sustainable investments that the financial product partially intends to make, not cause significant harm to any environmental or social sustainable investment objective?**

In order to ensure that Sustainable Investments do not significantly harm any other environmental and/or social objective, the Investment Manager is leveraging the PAI indicators, whereby significance thresholds have been defined to identify significantly harmful issuers. Issuers not meeting the significance threshold can be engaged for a limited time period to remediate the adverse impact. Otherwise, if the issuer does not meet the defined significance thresholds twice subsequently or in case of a failed engagement, it does not pass the DNSH assessment. Investments in securities of issuers which do not pass the DNSH assessment are not counted as sustainable investments.

● **How have the indicators for adverse impacts on sustainability factors been taken into account?**

All mandatory PAI indicators are considered either as part of the application of the exclusion criteria or through thresholds on a sectorial or absolute basis. Significance thresholds have been defined and they refer to qualitative or quantitative criteria.

Recognizing the lack of data coverage for some of the PAI indicators equivalent data points are used to assess PAI indicators when applying the DNSH assessment, when relevant, for the following indicators for corporates: share of non-renewable energy consumption and production, activities negatively affecting biodiversity-sensitive areas, emissions to water, lack of processes and compliance mechanisms to monitor compliance with UNGC principles and OECD Guidelines for Multinational Enterprises; for sovereigns: GHG Intensity and investee countries subject to social violations. In case of securities which

Principal adverse impacts are the most significant negative impacts of investment decisions on sustainability factors relating to environmental, social and employee matters, respect for human rights, anti-corruption and anti-bribery matters.

finance specific projects contributing to environmental or social objectives equivalent data at project level might be used to ensure that Sustainable Investments do not significantly harm any other environmental and/or social objective. The Investment Manager will strive to increase data coverage for PAI indicators with low data coverage by engaging with issuers and data providers. The Investment Manager will regularly evaluate whether the availability of data has increased sufficiently to potentially include assessment of such data in the investment process.

● *How are the sustainable investments aligned with the OECD Guidelines for Multinational Enterprises and the UN Guiding Principles on Business and Human Rights? Details:*

The Investment Manager's sustainable minimum exclusion list screens out companies based on their involvement in controversial practices against international norms. The core normative framework consists of the Principles of the UN Global Compact, the OECD Guidelines for Multinational Enterprises and the UN Guiding Principles for Business and Human Rights. Securities issued by companies having a severe violation of these frameworks will be restricted from the investment universe.

The EU Taxonomy sets out a "do not significant harm" principle by which Taxonomy-aligned investments should not significantly harm EU Taxonomy objectives and is accompanied by specific EU criteria.

The "do not significant harm" principle applies only to those investments underlying the financial product that take into account the EU criteria for environmentally sustainable economic activities. The investments underlying the remaining portion of this financial product do not take into account the EU criteria for environmentally sustainable economic activities.

Any other sustainable investments must also not significantly harm any environmental or social objectives.



Does this financial product consider principal adverse impacts on sustainability factors?

Yes

No

The Management Company has joined the Net Zero Asset Manager Initiative and considers PAI indicators through stewardship including engagement, both are relevant to mitigate potential adverse impact as a company.

Due to the commitment to the Net Zero Asset Manager Initiative, the Management Company aims to reduce greenhouse gas emissions in partnership with asset owner clients on decarbonisation goals, consistent with an ambition to reach net zero emission by 2050 or sooner across all assets under management. As part of this objective the Management Company will set an interim target for the proportion of assets to be managed in line with the attainment of net zero emissions by 2050 or sooner.

The Sub-Fund's Investment Manager addresses PAI indicators regarding greenhouse gas emission, biodiversity, water, waste as well as social and employee matters for corporate issuers, and, where relevant, the freedom house index is applied to investments in sovereigns. PAI indicators are considered within the Investment Manager's investment process through the means of exclusions as described in the "binding elements" section of the Sub-Fund.

The data coverage for the data required for the PAI indicators is heterogenous. The data coverage related to biodiversity, water and waste is low and the related PAI indicators are considered through exclusion of securities issued by companies having a severe violation / breach of principles and guidelines such as the Principles of the United Nations Global Compact, the OECD Guidelines for Multinational Enterprises, and the United Nations Guiding Principles for Business and Human Rights on the grounds of problematic practices around human rights, labour rights, environment, and corruption issues. Therefore, the Investment Manager will strive to increase data coverage for PAI indicators with low data coverage. The Investment Manager will regularly evaluate whether the availability of data has increased sufficiently to potentially include assessment of such data in the investment process.

The following PAI indicators are considered:

Applicable to corporate issuers

- GHG Emissions
- Carbon footprint
- GHG Intensity of investee companies
- Exposure to companies active in the fossil fuel sector

- Activities negatively affecting biodiversity-sensitive areas
- Emissions to water
- Hazardous waste ratio
- Violation of UN Global compact principles
- Lack of processes and compliance mechanisms to monitor compliance with UN Global Compact principles
- Board gender diversity
- Exposure to controversial weapons

Applicable to sovereign and supranational issuers

- Investee countries subject to social violations

The information on the PAI indicators will be available in the end-year report of the Sub-Fund.



What investment strategy does this financial product follow?

The investment strategy guides investment decisions based on factors such as investment objectives and risk tolerance.

Allianz ActiveInvest Balanced's investment objective is to invest in a broad range of asset classes, in particular in the global bond-, equity-, alternative- and money markets. The Sub-Fund achieves its investment objective by investing in investment funds (including internal SFDR Target Funds) with different regional focuses from a global investment universe. Overall, the goal is to achieve over the medium-term a performance comparable to a balanced portfolio consisting of global Equity Markets and Euro Bond Markets. The assessment of the volatility of the capital markets by the Investment Manager is an important factor in this process, with the aim of typically not falling below or exceeding a volatility of the Share price within a range of 6% to 12% on a medium to long-term average. A Sub-Fund managed according to the Multi Asset Sustainability Strategy ("MAS Strategy") invests in (i) Equities and / or Debt Securities of companies that either provide for environmental and/or social characteristics and/or pursue activities contributing to an environmental or social objective and / or invests (ii) in Green Bonds and/or Social Bonds, and/or in Sustainability Bonds and/or (iii) in SFDR Target Funds.

In case of direct investments in Equities and/or Debt Securities, the Sub-Fund's Investment Manager may choose one or more of the below strategies that promote environmental and/or social characteristics and/or pursue activities contributing to an environmental or social objective:

- SRI Strategy

The Sub-Fund or strategy promotes environmental and social characteristics through integrating environmental, social, human rights, governance and business behaviour factors into the Sub-Fund's investment process through a best-in-class approach. This encompasses the evaluation of corporate or sovereign issuers based on an SRI Rating that it is used to construct the portfolio.

- Climate Engagement with Outcome Strategy

The Sub-Fund or strategy promotes environmental characteristics through the engagement with the top 10 carbon emitting issuers to encourage their transition pathway to a low carbon economy by setting objectives which are sector specific.

- SDG-Aligned & SDG-Aligned Type A Strategy

The Sub-Fund's or strategy's Sustainable Investment objective is to invest in Equities and/or in Debt Securities of companies providing solutions that create positive environmental and social outcomes, as assessed by the contribution of companies' outputs to the attainment of one or more of the SDGs or other Sustainable Investment objectives, which the Sub-Fund's Investment Manager may additionally determine and to which the companies contribute to.

- Green Bond Strategy

The Sub-Fund's or strategy's Sustainable Investment objective is to mobilize capital markets towards the transition to a low carbon society, natural capital preservation and adaptation to climate change. The Sub-Fund or strategy invests primarily in Green Bonds financing climate change mitigation or adaptation projects or other environmental sustainability projects, notably in the following fields: energy efficiency, renewable energy, raw materials, water and land, waste management, greenhouse gas emissions reduction, biodiversity preservation or circular economy.

- Green Transition Strategy

The Sub-Fund or strategy promotes environmental and/or social characteristics through the mobilization of capital markets towards the transition to a low carbon society, natural capital preservation and adaptation to climate change.

- KPI Strategy (Absolute)

A Sub-Fund or strategy managed according to the Sustainability Key Performance Indicator Strategy (Absolute) ("KPI Strategy (Absolute)") promotes environmental objectives by applying an investment objective related to an environmental key performance indicator referred to as "Sustainability KPI" to provide transparency on the measurable sustainability outcome pursued. The "Sustainability KPI" to be measured is the GHG Intensity defined by the Weighted Average GHG Intensity (Sales) of issuers included in the Fund's portfolio. GHG Intensity will be addressed by ensuring a pre-determined year-on-year improvement pathway of the weighted average GHG Intensity on Fund's portfolio level at the Fund's fiscal year ends.

- KPI Strategy (Relative)

A Sub-Fund or strategy managed according to the Sustainability Key Performance Indicator Strategy (Relative) ("KPI Strategy (Relative)") promotes environmental objectives by applying an investment objective related to an environmental key performance indicator referred to as "Sustainability KPI" to provide transparency on the measurable sustainability outcome pursued. The "Sustainability KPI" to be measured is the GHG Intensity of issuers acquired by the Fund defined by the Weighted Average GHG Intensity (Sales). GHG Intensity of the Fund will be addressed by outperforming the Fund's benchmark (respectively the Weighted Average GHG Intensity of the issuers included in the Fund's benchmark) in terms of Weighted Average GHG Intensity.

- ESG Score Strategy

A Sub-Fund or strategy managed according to the ESG Score Strategy promotes Environment, Social and Governance factors through the ESG Score Strategy. The ESG Score Strategy aims to measure a company's resilience to long-term risks across the three pillars of Environment, Social and Governance. ESG pillars will be addressed by outperforming the Weighted Average ESG Score of issuers whose shares have been acquired by the Fund against the Weighted Average ESG Score of issuers which are components of Fund's benchmark.

- KPI Strategy (Absolute Threshold)

A Sub-Fund or strategy managed according to the Sustainability Key Performance Indicator Strategy (Absolute Threshold) ("KPI Strategy (Absolute Threshold)") targets a specific minimum allocation into Sustainable Investments. Sustainable investments are investments in economic activities which contribute to environmental and/or social objectives, for which the Investment Managers uses as reference frameworks the UN Sustainable Development Goals (SDGs), as well as the objectives of the EU Taxonomy.

The Sub-Fund's general investment approach (Sub-Fund's applicable General Asset Class Principles in combination with its individual investment restrictions) is described in the prospectus.

● **What are the binding elements of the investment strategy used to select the investments to attain each of the environmental or social characteristics promoted by this financial product?**

A Sub-Fund managed according to the Multi Asset Sustainability Strategy ("MAS Strategy") invests in (i) Equities and / or Debt Securities of companies that either provide for environmental and/or social characteristics and/or pursue activities contributing to an environmental or social objective and / or invests (ii) in Green Bonds and/or Social Bonds, and/or in Sustainability Bonds and/or (iii) in SFDR Target Funds.

Overall, the Investment Manager is required to invest min 70% of Sub-Fund's assets in SFDR Target Funds and/or in Equities and/or Debt Securities in accordance with the Multi Asset Sustainability Strategy.

- Application of the following sustainable minimum exclusion criteria for direct investments (with exception of cash, derivatives, external Target Funds, and internal Target Funds not following a sustainable strategy):
- securities issued by companies having a severe violation / breach of principles and guidelines such as the Principles of the United Nations Global Compact, the OECD Guidelines for Multinational Enterprises, and the United Nations Guiding Principles for Business and Human Rights on the grounds of problematic practices around human rights, labour rights, environment, and corruption issues,
- securities issued by companies involved in controversial weapons (anti-personnel mines, cluster munitions, chemical weapons, biological weapons, depleted uranium, white phosphorus, and nuclear weapons),
- securities issued by companies that derive more than 10% of their revenues from weapons, military equipment, and services,

- securities issued by companies that derive more than 10% of their revenue from thermal coal extraction
- securities issued by utility companies that generate more than 20% of their revenues from coal,
- securities issued by companies involved in the production of tobacco, and securities issued by companies involved in the distribution of tobacco with more than 5% of their revenues

Direct investments in sovereign issuers with an insufficient freedom house index score are excluded.

The sustainable minimum exclusion criteria are based on information from an external data provider and coded in pre- and post-trade compliance. The review is performed at least half yearly.

● **What is the committed minimum rate to reduce the scope of the investments considered prior to the application of that investment strategy?**

The Sub-Fund does not commit to reduce the scope of the investments by a certain minimum rate.

● **What is the policy to assess good governance practices of the investee companies?**

Good governance principles are considered by screening out companies based on their involvement in controversies around international norms corresponding to the four good governance practices: sound management structures, employee relations, remuneration of staff and tax compliance. Companies having a severe violation in either of those areas will not be investible. For certain cases, flagged issuers shall be on a watch list. These companies will appear on this watch list when the Investment Manager believes that engagement may lead to improvements or when the company is assessed to take remedial actions. Companies on the watch list remain investible unless the Investment Manager believes that the engagement or the remedial actions of the company does not lead to the desired remedy of the severe controversy.

In addition, the Sub-Fund's Investment Manager is committed to actively encourage open dialogues with investee companies on corporate governance, proxy voting and broader sustainability issues in advance of shareholder meetings (regularly for direct investments in shares). The Sub-Fund's Investment Manager's approach to proxy voting and company engagement is set out in the Management Company's Stewardship Statement.

Good governance practices include sound management structures, employee relations, remuneration of staff and tax compliance.



What is the asset allocation planned for this financial product?

Asset allocation describes the share of investments in specific assets.

Min. 70% of the Sub-Funds' assets are used to meet the environmental or social characteristics promoted by this Sub-Fund. A low portion of the Sub-Fund might contain assets which do not promote environmental or social characteristics. Example of such instruments are derivatives, cash and deposits, some Target Funds and investment with temporarily divergent or absent environmental, social, or good governance qualifications or investments outside of the specified quota to be invested as part of the Multi Asset Sustainability Strategy. Min. 10% of the Sub-Funds' assets will be invested in Sustainable Investments. The minimum percentage of investments that are aligned with the EU Taxonomy is 0.01%. The Sub-Fund's Investment Manager does not commit to a minimum share of environmentally Sustainable Investments that are not aligned with the EU Taxonomy. The Sub-Fund's Investment Manager does not commit to a minimum share of socially sustainable investments. While the Sub-Fund cannot commit to a minimum share of environmentally or socially sustainable investments, such investments may be freely allocated to within the Sub-Fund aggregated sustainable investment commitment disclosed (min. 10%).

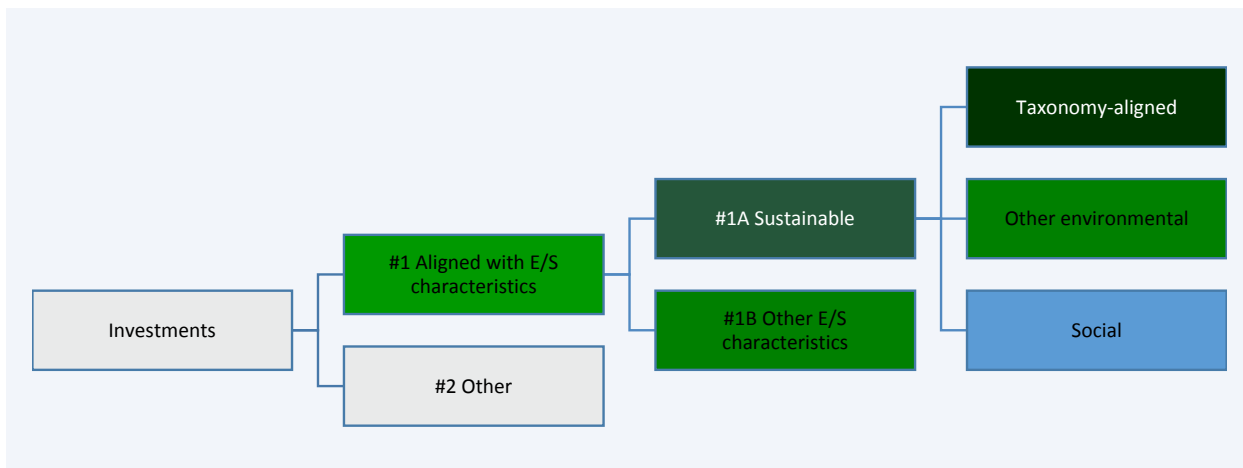

#1 Aligned with E/S characteristics includes the investments of the financial product used to attain the environmental or social characteristics promoted by the financial product.

#2 Other includes the remaining investments of the financial product which are neither aligned with the environmental or social characteristics, nor are qualified as sustainable investments.

The category #1 Aligned with E/S characteristics covers:

- The sub-category #1A Sustainable covers sustainable investments with environmental or social objectives.
- The sub-category #1B Other E/S characteristics covers investments aligned with the environmental or social characteristics that do not qualify as sustainable investments.

● How does the use of derivatives attain the environmental or social characteristics promoted by the financial product?

Not applicable



To what minimum extent are sustainable investments with an environmental objective aligned with the EU Taxonomy?

The Taxonomy-aligned investments include debt and/or equity in environmentally sustainable economic activities aligned with the EU-Taxonomy. The minimum percentage of investments that are aligned with the EU Taxonomy is 0.01%. Taxonomy-aligned data is provided by an external data provider. The Investment Manager has assessed the quality of such data. The data will not be subject to an assurance provided by auditors or a review by third parties. The data will not reflect any data in government bonds. As of today, there is no recognized methodology available to determine the proportion of Taxonomy-aligned activities when investing in government bonds.

Taxonomy-aligned activities in this disclosure are based on share of turnover. Pre-contractual figures use turnover as its financial metric as a default in line with the regulatory requirements and based on the fact that complete, verifiable or up-to date data for CAPEX and/or OPEX as financial metric is even less available.

Taxonomy-aligned data is only in rare cases data reported by companies in accordance with the EU Taxonomy. The data provider has derived Taxonomy-aligned data from other available equivalent public data.

● Does the financial product invest in fossil gas and/or nuclear energy related activities that comply with the EU Taxonomy ¹?

- Yes:
 - In fossil gas
 - In nuclear energy
- No

The Sub-Fund does not pursue any investments in fossil gas and/or nuclear energy related activities that comply with the EU Taxonomy. Nevertheless, as result of this investment strategy, investments may occur in corporates which are also active in these activities. Further information will be provided as part of the annual reporting, if relevant.

Taxonomy-aligned activities are expressed as a share of:

- turnover reflecting the share of revenue from green activities of investee companies
- capital expenditure (CapEx) showing the green investments made by investee companies, e.g. for a transition to a green

¹ Fossil gas and/or nuclear related activities will only comply with the EU Taxonomy where they contribute to limiting climate change ("climate change mitigation") and do not significantly harm any EU Taxonomy objective - see explanatory note in the left hand margin. The full criteria for fossil gas and nuclear energy economic activities that comply with the EU Taxonomy are laid down in Commission Delegated Regulation (EU) 2022/1214.

economy.
 - **operational expenditure (OpEx)** reflecting green operational activities of investee companies.

The two graphs below show in green the minimum percentage of investments that are aligned with the EU Taxonomy. As there is no appropriate methodology to determine the Taxonomy-alignment of sovereign bonds*, the first graph shows the Taxonomy-alignment in relation to all the investments of the financial product including sovereign bonds, while the second graph shows the Taxonomy-alignment only in relation to the investments of the financial product other than sovereign bonds.

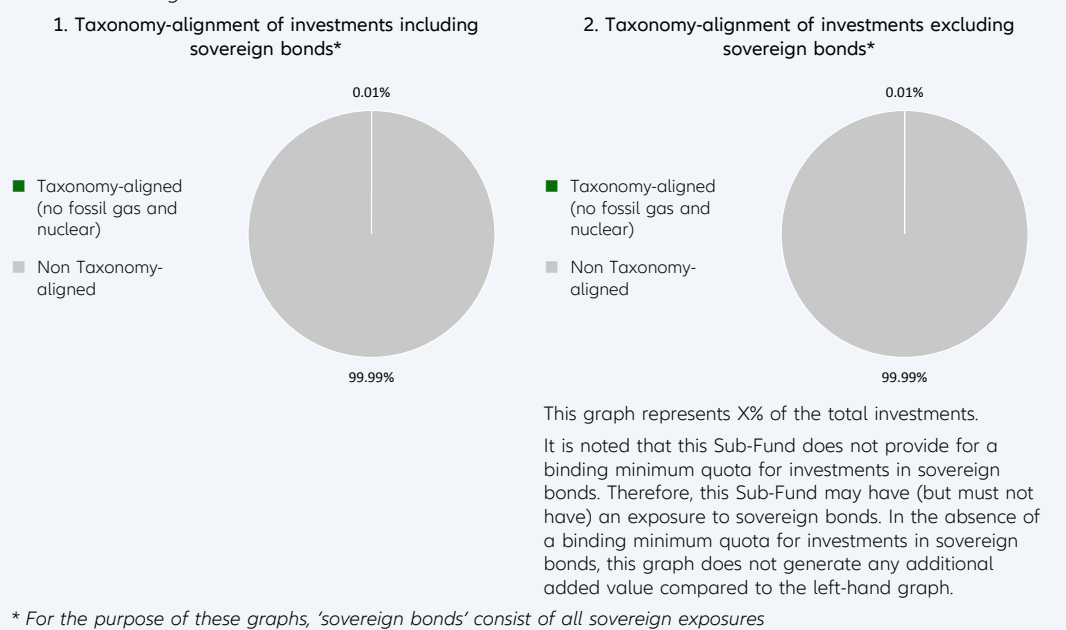

Enabling activities directly enable other activities to make a substantial contribution to an environmental objective.

Transitional activities are activities for which low-carbon alternatives are not yet available and among others have greenhouse gas emission levels corresponding to the best performance.

● **What is the minimum share of investments in transitional and enabling activities?**

The Sub-Fund's Investment Manager does not commit to a split of minimum taxonomy alignment into transitional, enabling activities and own performance.



What is the minimum share of sustainable investments with an environmental objective that are not aligned with the EU Taxonomy?

Taxonomy-aligned investments are considered a sub-category of Sustainable Investments. If an investment is not Taxonomy-aligned since the activity is not yet covered under the EU Taxonomy or the positive contribution is not substantial enough to comply with the Taxonomy technical screening criteria, the investment can still be considered an environmentally Sustainable Investment provided it complies with all criteria. The Investment Manager does not commit to a minimum share of environmentally Sustainable Investments that are not aligned with the EU Taxonomy. The overall sustainable investment share may also include investments with an environmental objective in economic activities that do not qualify as environmentally sustainable under the EU Taxonomy, and while the Sub-Fund cannot commit to a minimum share of environmentally or socially sustainable investments, such investments may be freely allocated to within the Sub-Fund aggregated sustainable investment commitment disclosed (min 10%).

are sustainable investments with an environmental objective that **do not take into account the criteria** for environmentally sustainable economic activities under the EU Taxonomy.



What is the minimum share of socially sustainable investments?

The Investment Manager defines Sustainable Investments based on internal research, which uses, among others, the UN Sustainable Development Goals (SDGs), as well as the objectives of the EU Taxonomy as reference frameworks. The Investment Manager does not commit to a minimum share of socially Sustainable Investments, as the SDGs contain environmental as well as social objectives. The overall sustainable investment share may also include investments with a social objective, and while the Sub-Fund cannot commit to a minimum share of environmentally or socially sustainable investments, such investments may be freely allocated to within the Sub-Fund aggregated sustainable investment commitment disclosed (min 10%).



What investments are included under “#2 Other”, what is their purpose and are there any minimum environmental or social safeguards?

Under “#2 Other” investments into cash, Target Funds, or derivatives can be included. Derivatives might be used for efficient portfolio management (including risk hedging) and/or investment purposes, and Target Funds to benefit from a specific strategy. For those investments no environmental or social safeguards are applied.



Is a specific index designated as a reference benchmark to determine whether this financial product is aligned with the environmental and/or social characteristics that it promotes?

No reference benchmark has been designated for the purpose of attaining the environmental and/or social characteristics promoted by the Sub-Fund.

- How is the reference benchmark continuously aligned with each of the environmental or social characteristics promoted by the financial product?

Not applicable

- How is the alignment of the investment strategy with the methodology of the index ensured on a continuous basis?

Not applicable

- How does the designated index differ from a relevant broad market index?

Not applicable

- Where can the methodology used for the calculation of the designated index be found?

Not applicable



Where can I find more product specific information online?

More product-specific information can be found on the website: <https://regulatory.allianzgi.com/SFDR>

Reference benchmarks are indexes to measure whether the financial product attains the environmental or social characteristics that they promote.

Template pre-contractual disclosure for the financial products referred to in Article 8, paragraphs 1, 2 and 2a, of Regulation (EU) 2019/2088 and Article 6, first paragraph, of Regulation (EU) 2020/852

Product name:

Allianz ActiveInvest Defensive

Legal entity identifier: 52990094VFHIL03QZ388

Environmental and/or social characteristics

Sustainable investment means an investment in an economic activity that contributes to an environmental or social objective, provided that the investment does not significantly harm any environmental or social objective and that the investee companies follow good governance practices.

The EU Taxonomy is a classification system laid down in Regulation (EU) 2020/852, establishing a list of environmentally sustainable economic activities. That Regulation does not include a list of socially sustainable economic activities. Sustainable investments with an environmental objective might be aligned with the Taxonomy or not.

Does this financial product have a sustainable investment objective?	
Yes	No
<input type="checkbox"/> It will make a minimum of sustainable investments with an environmental objective: ___% <input type="checkbox"/> in economic activities that qualify as environmentally sustainable under the EU Taxonomy <input type="checkbox"/> in economic activities that do not qualify as environmentally sustainable under the EU Taxonomy	<input checked="" type="checkbox"/> It promotes Environmental/Social (E/S) characteristics and while it does not have as its objective a sustainable investment, it will have a minimum proportion of 10.00% of sustainable investments <input checked="" type="checkbox"/> with an environmental objective in economic activities that qualify as environmentally sustainable under the EU Taxonomy <input checked="" type="checkbox"/> with an environmental objective in economic activities that do not qualify as environmentally sustainable under the EU Taxonomy <input checked="" type="checkbox"/> with a social objective
<input type="checkbox"/> It will make a minimum of sustainable investments with a social objective ___%	<input type="checkbox"/> It promotes E/S characteristics, but will not make any sustainable investments



What environmental and/or social characteristics are promoted by this financial product?

Allianz ActiveInvest Defensive (the "Sub-Fund") promotes a broad range of environmental and/or social characteristics. The Sub-Fund invests at least 70% of its assets following the "Multi Asset Sustainability Strategy" which includes, but is not limited to, various sustainability strategies of the management company and/or, invests in Green Bonds and/or Social Bonds, and/or Sustainability Bonds and/or SFDR Article 8 & 9 Target Funds ("SFDR Target Funds").

Depending on the sustainability strategy selected by the Investment Manager the promoted environmental and/or social characteristics could comprise environmental, social, human rights, governance, business behaviour factors or investments in companies providing solutions that create positive environmental and social outcomes.

In addition, sustainable minimum exclusion criteria apply.

No reference benchmark has been designated for the purpose of attaining the environmental and/or social characteristics promoted by the Sub-Fund.

- **What sustainability indicators are used to measure the attainment of each of the environmental or social characteristics promoted by this financial product?**

As part of the Multi Asset Sustainability Strategy the Investment Manager allocates at least 70% of Fund's assets in various sustainability approaches.

Sustainability indicators measure how the environmental or social characteristics promoted by the financial product are attained.

To measure the attainment of the environmental and/or social characteristics the following sustainability indicators are used and reported on, at the fiscal year end:

- The actual percentage of the Sub-Fund's assets invested in Green Bonds, and/or Social Bonds, and/or Sustainability Bonds and/or in SFDR Target Funds and/or in Equities and/or Debt Securities in accordance with the Multi Asset Sustainability Strategy.
- In case the Investment Manager decides to directly invest in Debt or Equity Securities as part of the Multi Asset Sustainability Strategy the adherence to the respective binding element will be reported.
- Confirmation that Principal Adverse Impacts (PAIs) of investment decisions on sustainability factors are considered through the application of exclusion criteria (with exception of cash, derivatives, external Target Funds and internal Target Funds not following a sustainability strategy).

● **What are the objectives of the sustainable investments that the financial product partially intends to make and how does the sustainable investment contribute to such objectives?**

Sustainable investments contribute to environmental and/or social objectives, for which the Investment Manager uses as reference frameworks, among others, the UN Sustainable Development Goals (SDGs), as well as the objectives of the EU Taxonomy:

1. Climate Change Mitigation
2. Climate Change Adaptation
3. Sustainable Use and Protection of Water and Marine Resources
4. Transition to a Circular Economy
5. Pollution Prevention and Control
6. Protection and Restoration of Biodiversity and Ecosystems

The assessment of the positive contribution to the environmental or social objectives is based on a proprietary framework which combines quantitative elements with qualitative inputs from internal research. The methodology applies first a quantitative breakdown of a securities issuer into its business activities. The qualitative element of the framework is an assessment if business activities contribute positively to an environmental or a social objective.

To calculate the positive contribution on the Sub-Fund level the revenue share of each issuer attributable to business activities contributing to environmental and/or social objectives is considered provided the issuer is satisfying the Do No Significant Harm ("DNSH") and Good Governance principles, and an asset-weighted aggregation is performed as a second step. Moreover, for certain types of securities, which finance specific projects contributing to environmental or social objectives the overall investment is considered to contribute to environmental and/or social objectives, but also for these a DNSH as well as a Good Governance check for issuers is performed.

● **How do the sustainable investments that the financial product partially intends to make, not cause significant harm to any environmental or social sustainable investment objective?**

In order to ensure that Sustainable Investments do not significantly harm any other environmental and/or social objective, the Investment Manager is leveraging the PAI indicators, whereby significance thresholds have been defined to identify significantly harmful issuers. Issuers not meeting the significance threshold can be engaged for a limited time period to remediate the adverse impact. Otherwise, if the issuer does not meet the defined significance thresholds twice subsequently or in case of a failed engagement, it does not pass the DNSH assessment. Investments in securities of issuers which do not pass the DNSH assessment are not counted as sustainable investments.

● **How have the indicators for adverse impacts on sustainability factors been taken into account?**

All mandatory PAI indicators are considered either as part of the application of the exclusion criteria or through thresholds on a sectorial or absolute basis. Significance thresholds have been defined and they refer to qualitative or quantitative criteria.

Recognizing the lack of data coverage for some of the PAI indicators equivalent data points are used to assess PAI indicators when applying the DNSH assessment, when relevant, for the following indicators for corporates: share of non-renewable energy consumption and production, activities negatively affecting biodiversity-sensitive areas, emissions to water, lack of processes and compliance mechanisms to monitor compliance with UNGC principles and OECD Guidelines for Multinational Enterprises; for sovereigns: GHG Intensity and investee countries subject to social violations. In case of securities which

Principal adverse impacts are the most significant negative impacts of investment decisions on sustainability factors relating to environmental, social and employee matters, respect for human rights, anti-corruption and anti-bribery matters.

finance specific projects contributing to environmental or social objectives equivalent data at project level might be used to ensure that Sustainable Investments do not significantly harm any other environmental and/or social objective. The Investment Manager will strive to increase data coverage for PAI indicators with low data coverage by engaging with issuers and data providers. The Investment Manager will regularly evaluate whether the availability of data has increased sufficiently to potentially include assessment of such data in the investment process.

- *How are the sustainable investments aligned with the OECD Guidelines for Multinational Enterprises and the UN Guiding Principles on Business and Human Rights? Details:*

The Investment Manager's sustainable minimum exclusion list screens out companies based on their involvement in controversial practices against international norms. The core normative framework consists of the Principles of the UN Global Compact, the OECD Guidelines for Multinational Enterprises and the UN Guiding Principles for Business and Human Rights. Securities issued by companies having a severe violation of these frameworks will be restricted from the investment universe.

The EU Taxonomy sets out a "do not significant harm" principle by which Taxonomy-aligned investments should not significantly harm EU Taxonomy objectives and is accompanied by specific EU criteria.

The "do not significant harm" principle applies only to those investments underlying the financial product that take into account the EU criteria for environmentally sustainable economic activities. The investments underlying the remaining portion of this financial product do not take into account the EU criteria for environmentally sustainable economic activities.

Any other sustainable investments must also not significantly harm any environmental or social objectives.



Does this financial product consider principal adverse impacts on sustainability factors?

Yes

No

The Management Company has joined the Net Zero Asset Manager Initiative and considers PAI indicators through stewardship including engagement, both are relevant to mitigate potential adverse impact as a company.

Due to the commitment to the Net Zero Asset Manager Initiative, the Management Company aims to reduce greenhouse gas emissions in partnership with asset owner clients on decarbonisation goals, consistent with an ambition to reach net zero emission by 2050 or sooner across all assets under management. As part of this objective the Management Company will set an interim target for the proportion of assets to be managed in line with the attainment of net zero emissions by 2050 or sooner.

The Sub-Fund's Investment Manager addresses PAI indicators regarding greenhouse gas emission, biodiversity, water, waste as well as social and employee matters for corporate issuers, and, where relevant, the freedom house index is applied to investments in sovereigns. PAI indicators are considered within the Investment Manager's investment process through the means of exclusions as described in the "binding elements" section of the Sub-Fund.

The data coverage for the data required for the PAI indicators is heterogenous. The data coverage related to biodiversity, water and waste is low and the related PAI indicators are considered through exclusion of securities issued by companies having a severe violation / breach of principles and guidelines such as the Principles of the United Nations Global Compact, the OECD Guidelines for Multinational Enterprises, and the United Nations Guiding Principles for Business and Human Rights on the grounds of problematic practices around human rights, labour rights, environment, and corruption issues. Therefore, the Investment Manager will strive to increase data coverage for PAI indicators with low data coverage. The Investment Manager will regularly evaluate whether the availability of data has increased sufficiently to potentially include assessment of such data in the investment process.

The following PAI indicators are considered:

Applicable to corporate issuers

- GHG Emissions
- Carbon footprint
- GHG Intensity of investee companies
- Exposure to companies active in the fossil fuel sector

- Activities negatively affecting biodiversity-sensitive areas
- Emissions to water
- Hazardous waste ratio
- Violation of UN Global compact principles
- Lack of processes and compliance mechanisms to monitor compliance with UN Global Compact principles
- Board gender diversity
- Exposure to controversial weapons

Applicable to sovereign and supranational issuers

- Investee countries subject to social violations

The information on the PAI indicators will be available in the end-year report of the Sub-Fund.



What investment strategy does this financial product follow?

The investment strategy guides investment decisions based on factors such as investment objectives and risk tolerance.

Allianz ActiveInvest Defensive's investment objective is to invest in a broad range of asset classes, in particular in the global bond-, equity-, alternative- and money markets. The Sub-Fund achieves its investment objective by investing in investment funds (including internal SFDR Target Funds) with different regional focuses from a global investment universe. Overall, the goal is to achieve over the medium-term a performance comparable to a defensive portfolio consisting of global Equity Markets and Euro Bond Markets. The assessment of the volatility of the capital markets by the Investment Manager is an important factor in this process, with the aim of typically not falling below or exceeding a volatility of the Share price within a range of 3% to 9% on a medium to long-term average. A Sub-Fund managed according to the Multi Asset Sustainability Strategy ("MAS Strategy") invests in (i) Equities and / or Debt Securities of companies that either provide for environmental and/or social characteristics and/or pursue activities contributing to an environmental or social objective and / or invests (ii) in Green Bonds and/or Social Bonds, and/or in Sustainability Bonds and/or (iii) in SFDR Target Funds.

In case of direct investments in Equities and/or Debt Securities, the Sub-Fund's Investment Manager may choose one or more of the below strategies that promote environmental and/or social characteristics and/or pursue activities contributing to an environmental or social objective:

- SRI Strategy

The Sub-Fund or strategy promotes environmental and social characteristics through integrating environmental, social, human rights, governance and business behaviour factors into the Sub-Fund's investment process through a best-in-class approach. This encompasses the evaluation of corporate or sovereign issuers based on an SRI Rating that it is used to construct the portfolio.

- Climate Engagement with Outcome Strategy

The Sub-Fund or strategy promotes environmental characteristics through the engagement with the top 10 carbon emitting issuers to encourage their transition pathway to a low carbon economy by setting objectives which are sector specific.

- SDG-Aligned & SDG-Aligned Type A Strategy

The Sub-Fund's or strategy's Sustainable Investment objective is to invest in Equities and/or in Debt Securities of companies providing solutions that create positive environmental and social outcomes, as assessed by the contribution of companies' outputs to the attainment of one or more of the SDGs or other Sustainable Investment objectives, which the Sub-Fund's Investment Manager may additionally determine and to which the companies contribute to.

- Green Bond Strategy

The Sub-Fund's or strategy's Sustainable Investment objective is to mobilize capital markets towards the transition to a low carbon society, natural capital preservation and adaptation to climate change. The Sub-Fund or strategy invests primarily in Green Bonds financing climate change mitigation or adaptation projects or other environmental sustainability projects, notably in the following fields: energy efficiency, renewable energy, raw materials, water and land, waste management, greenhouse gas emissions reduction, biodiversity preservation or circular economy.

- Green Transition Strategy

The Sub-Fund or strategy promotes environmental and/or social characteristics through the mobilization of capital markets towards the transition to a low carbon society, natural capital preservation and adaptation to climate change.

- KPI Strategy (Absolute)

A Sub-Fund or strategy managed according to the Sustainability Key Performance Indicator Strategy (Absolute) ("KPI Strategy (Absolute)") promotes environmental objectives by applying an investment objective related to an environmental key performance indicator referred to as "Sustainability KPI" to provide transparency on the measurable sustainability outcome pursued. The "Sustainability KPI" to be measured is the GHG Intensity defined by the Weighted Average GHG Intensity (Sales) of issuers included in the Fund's portfolio. GHG Intensity will be addressed by ensuring a pre-determined year-on-year improvement pathway of the weighted average GHG Intensity on Fund's portfolio level at the Fund's fiscal year ends.

- KPI Strategy (Relative)

A Sub-Fund or strategy managed according to the Sustainability Key Performance Indicator Strategy (Relative) ("KPI Strategy (Relative)") promotes environmental objectives by applying an investment objective related to an environmental key performance indicator referred to as "Sustainability KPI" to provide transparency on the measurable sustainability outcome pursued. The "Sustainability KPI" to be measured is the GHG Intensity of issuers acquired by the Fund defined by the Weighted Average GHG Intensity (Sales). GHG Intensity of the Fund will be addressed by outperforming the Fund's benchmark (respectively the Weighted Average GHG Intensity of the issuers included in the Fund's benchmark) in terms of Weighted Average GHG Intensity.

- ESG Score Strategy

A Sub-Fund or strategy managed according to the ESG Score Strategy promotes Environment, Social and Governance factors through the ESG Score Strategy. The ESG Score Strategy aims to measure a company's resilience to long-term risks across the three pillars of Environment, Social and Governance. ESG pillars will be addressed by outperforming the Weighted Average ESG Score of issuers whose shares have been acquired by the Fund against the Weighted Average ESG Score of issuers which are components of Fund's benchmark.

- KPI Strategy (Absolute Threshold)

A Sub-Fund or strategy managed according to the Sustainability Key Performance Indicator Strategy (Absolute Threshold) ("KPI Strategy (Absolute Threshold)") targets a specific minimum allocation into Sustainable Investments. Sustainable investments are investments in economic activities which contribute to environmental and/or social objectives, for which the Investment Managers uses as reference frameworks the UN Sustainable Development Goals (SDGs), as well as the objectives of the EU Taxonomy.

The Sub-Fund's general investment approach (Sub-Fund's applicable General Asset Class Principles in combination with its individual investment restrictions) is described in the prospectus.

● **What are the binding elements of the investment strategy used to select the investments to attain each of the environmental or social characteristics promoted by this financial product?**

A Sub-Fund managed according to the Multi Asset Sustainability Strategy ("MAS Strategy") invests in (i) Equities and / or Debt Securities of companies that either provide for environmental and/or social characteristics and/or pursue activities contributing to an environmental or social objective and / or invests (ii) in Green Bonds and/or Social Bonds, and/or in Sustainability Bonds and/or (iii) in SFDR Target Funds.

Overall, the Investment Manager is required to invest min 70% of Sub-Fund's assets in SFDR Target Funds and/or in Equities and/or Debt Securities in accordance with the Multi Asset Sustainability Strategy.

- Application of the following sustainable minimum exclusion criteria for direct investments (with exception of cash, derivatives, external Target Funds, and internal Target Funds not following a sustainable strategy):
- securities issued by companies having a severe violation / breach of principles and guidelines such as the Principles of the United Nations Global Compact, the OECD Guidelines for Multinational Enterprises, and the United Nations Guiding Principles for Business and Human Rights on the grounds of problematic practices around human rights, labour rights, environment, and corruption issues,
- securities issued by companies involved in controversial weapons (anti-personnel mines, cluster munitions, chemical weapons, biological weapons, depleted uranium, white phosphorus, and nuclear weapons),
- securities issued by companies that derive more than 10% of their revenues from weapons, military equipment, and services,

- securities issued by companies that derive more than 10% of their revenue from thermal coal extraction,
- securities issued by utility companies that generate more than 20% of their revenues from coal,
- securities issued by companies involved in the production of tobacco, and securities issued by companies involved in the distribution of tobacco with more than 5% of their revenues.

Direct investments in sovereign issuers with an insufficient freedom house index score are excluded.

The sustainable minimum exclusion criteria are based on information from an external data provider and coded in pre- and post-trade compliance. The review is performed at least half yearly.

● **What is the committed minimum rate to reduce the scope of the investments considered prior to the application of that investment strategy?**

The Sub-Fund does not commit to reduce the scope of the investments by a certain minimum rate.

● **What is the policy to assess good governance practices of the investee companies?**

Good governance principles are considered by screening out companies based on their involvement in controversies around international norms corresponding to the four good governance practices: sound management structures, employee relations, remuneration of staff and tax compliance. Companies having a severe violation in either of those areas will not be investible. For certain cases, flagged issuers shall be on a watch list. These companies will appear on this watch list when the Investment Manager believes that engagement may lead to improvements or when the company is assessed to take remedial actions. Companies on the watch list remain investible unless the Investment Manager believes that the engagement or the remedial actions of the company does not lead to the desired remedy of the severe controversy.

In addition, the Sub-Fund's Investment Manager is committed to actively encourage open dialogues with investee companies on corporate governance, proxy voting and broader sustainability issues in advance of shareholder meetings (regularly for direct investments in shares). The Sub-Fund's Investment Manager's approach to proxy voting and company engagement is set out in the Management Company's Stewardship Statement.

Good governance practices include sound management structures, employee relations, remuneration of staff and tax compliance.



What is the asset allocation planned for this financial product?

Asset allocation describes the share of investments in specific assets.

Min. 70% of the Sub-Funds' assets are used to meet the environmental or social characteristics promoted by this Sub-Fund. A low portion of the Sub-Fund might contain assets which do not promote environmental or social characteristics. Example of such instruments are derivatives, cash and deposits, some Target Funds and investment with temporarily divergent or absent environmental, social, or good governance qualifications or investments outside of the specified quota to be invested as part of the Multi Asset Sustainability Strategy. Min. 10% of the Sub-Funds' assets will be invested in Sustainable Investments. The minimum percentage of investments that are aligned with the EU Taxonomy is 0.01%. The Sub-Fund's Investment Manager does not commit to a minimum share of environmentally Sustainable Investments that are not aligned with the EU Taxonomy. The Sub-Fund's Investment Manager does not commit to a minimum share of socially sustainable investments. While the Sub-Fund cannot commit to a minimum share of environmentally or socially sustainable investments, such investments may be freely allocated to within the Sub-Fund aggregated sustainable investment commitment disclosed (min.10%).

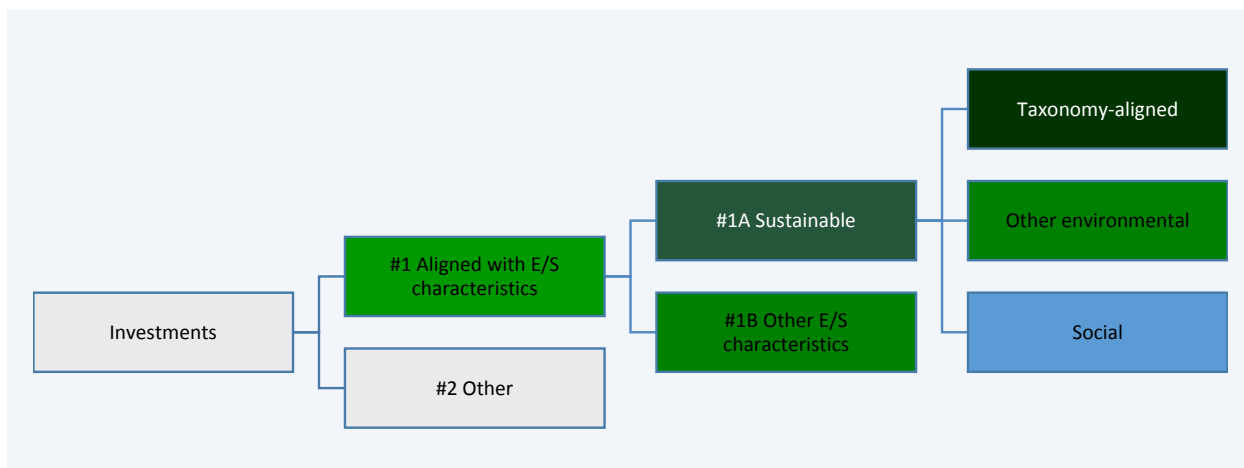

#1 Aligned with E/S characteristics includes the investments of the financial product used to attain the environmental or social characteristics promoted by the financial product.

#2 Other includes the remaining investments of the financial product which are neither aligned with the environmental or social characteristics, nor are qualified as sustainable investments.

The category **#1 Aligned with E/S characteristics** covers:

- The sub-category **#1A Sustainable** covers sustainable investments with environmental or social objectives.
- The sub-category **#1B Other E/S characteristics** covers investments aligned with the environmental or social characteristics that do not qualify as sustainable investments.

● **How does the use of derivatives attain the environmental or social characteristics promoted by the financial product?**

Not applicable



To what minimum extent are sustainable investments with an environmental objective aligned with the EU Taxonomy?

The Taxonomy-aligned investments include debt and/or equity in environmentally sustainable economic activities aligned with the EU-Taxonomy. The minimum percentage of investments that are aligned with the EU Taxonomy is 0.01%. Taxonomy-aligned data is provided by an external data provider. The Investment Manager has assessed the quality of such data. The data will not be subject to an assurance provided by auditors or a review by third parties. The data will not reflect any data in government bonds. As of today, there is no recognized methodology available to determine the proportion of Taxonomy-aligned activities when investing in government bonds.

Taxonomy-aligned activities in this disclosure are based on share of turnover. Pre-contractual figures use turnover as its financial metric as a default in line with the regulatory requirements and based on the fact that complete, verifiable or up-to date data for CAPEX and/or OPEX as financial metric is even less available.

Taxonomy-aligned data is only in rare cases data reported by companies in accordance with the EU Taxonomy. The data provider has derived Taxonomy-aligned data from other available equivalent public data.

● **Does the financial product invest in fossil gas and/or nuclear energy related activities that comply with the EU Taxonomy ¹?**

- Yes:
 - In fossil gas
 - In nuclear energy
- No

The Sub-Fund does not pursue any investments in fossil gas and/or nuclear energy related activities that comply with the EU Taxonomy. Nevertheless, as result of this investment strategy, investments may occur in corporates which are also active in these activities. Further information will be provided as part of the annual reporting, if relevant.

Taxonomy-aligned activities are expressed as a share of:
 - **turnover** reflecting the share of revenue from green activities of investee companies
 - **capital expenditure (CapEx)** showing the green investments made by investee companies, e.g. for a transition to a green

¹ Fossil gas and/or nuclear related activities will only comply with the EU Taxonomy where they contribute to limiting climate change ("climate change mitigation") and do not significantly harm any EU Taxonomy objective - see explanatory note in the left hand margin. The full criteria for fossil gas and nuclear energy economic activities that comply with the EU Taxonomy are laid down in Commission Delegated Regulation (EU) 2022/1214.

economy.
 - **operational expenditure (OpEx)** reflecting green operational activities of investee companies.

The two graphs below show in green the minimum percentage of investments that are aligned with the EU Taxonomy. As there is no appropriate methodology to determine the Taxonomy-alignment of sovereign bonds*, the first graph shows the Taxonomy-alignment in relation to all the investments of the financial product including sovereign bonds, while the second graph shows the Taxonomy-alignment only in relation to the investments of the financial product other than sovereign bonds.

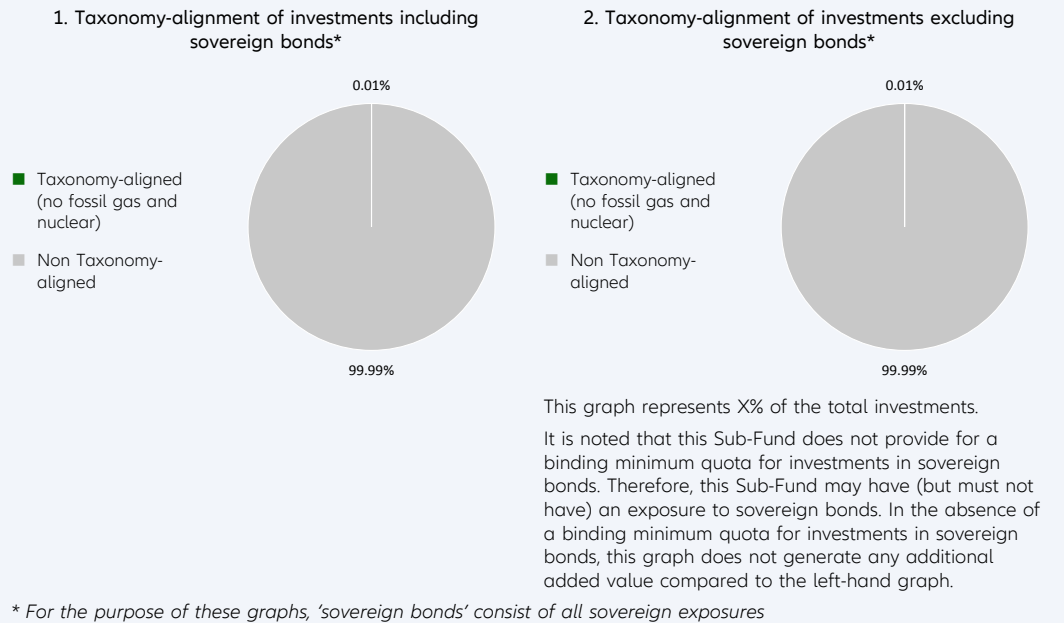

Enabling activities directly enable other activities to make a substantial contribution to an environmental objective.

Transitional activities are activities for which low-carbon alternatives are not yet available and among others have greenhouse gas emission levels corresponding to the best performance.

● **What is the minimum share of investments in transitional and enabling activities?**

The Sub-Fund's Investment Manager does not commit to a split of minimum taxonomy alignment into transitional, enabling activities and own performance.



What is the minimum share of sustainable investments with an environmental objective that are not aligned with the EU Taxonomy?

Taxonomy-aligned investments are considered a sub-category of Sustainable Investments. If an investment is not Taxonomy-aligned since the activity is not yet covered under the EU Taxonomy or the positive contribution is not substantial enough to comply with the Taxonomy technical screening criteria, the investment can still be considered an environmentally Sustainable Investment provided it complies with all criteria. The Investment Manager does not commit to a minimum share of environmentally Sustainable Investments that are not aligned with the EU Taxonomy. The overall sustainable investment share may also include investments with an environmental objective in economic activities that do not qualify as environmentally sustainable under the EU Taxonomy, and while the Sub-Fund cannot commit to a minimum share of environmentally or socially sustainable investments, such investments may be freely allocated to within the Sub-Fund aggregated sustainable investment commitment disclosed (min 10%).

are sustainable investments with an environmental objective that **do not take into account the criteria** for environmentally sustainable economic activities under the EU Taxonomy.



What is the minimum share of socially sustainable investments?

The Investment Manager defines Sustainable Investments based on internal research, which uses, among others, the UN Sustainable Development Goals (SDGs), as well as the objectives of the EU Taxonomy as reference frameworks. The Investment Manager does not commit to a minimum share of socially Sustainable Investments, as the SDGs contain environmental as well as social objectives. The overall sustainable investment share may also include investments with a social objective, and while the Sub-Fund cannot commit to a minimum share of environmentally or socially sustainable investments, such investments may be freely allocated to within the Sub-Fund aggregated sustainable investment commitment disclosed (min 10%).



What investments are included under “#2 Other”, what is their purpose and are there any minimum environmental or social safeguards?

Under “#2 Other” investments into cash, Target Funds, or derivatives can be included. Derivatives might be used for efficient portfolio management (including risk hedging) and/or investment purposes, and Target Funds to benefit from a specific strategy. For those investments no environmental or social safeguards are applied.



Is a specific index designated as a reference benchmark to determine whether this financial product is aligned with the environmental and/or social characteristics that it promotes?

No reference benchmark has been designated for the purpose of attaining the environmental and/or social characteristics promoted by the Sub-Fund.

- How is the reference benchmark continuously aligned with each of the environmental or social characteristics promoted by the financial product?

Not applicable

- How is the alignment of the investment strategy with the methodology of the index ensured on a continuous basis?

Not applicable

- How does the designated index differ from a relevant broad market index?

Not applicable

- Where can the methodology used for the calculation of the designated index be found?

Not applicable

Reference benchmarks are indexes to measure whether the financial product attains the environmental or social characteristics that they promote.



Where can I find more product specific information online?

More product-specific information can be found on the website: <https://regulatory.allianzgi.com/SFDR>

Template pre-contractual disclosure for the financial products referred to in Article 8, paragraphs 1, 2 and 2a, of Regulation (EU) 2019/2088 and Article 6, first paragraph, of Regulation (EU) 2020/852

Product name:

Allianz ActiveInvest Dynamic

Legal entity identifier: 529900HO90TX5SRRYZ37

Environmental and/or social characteristics

Sustainable investment means an investment in an economic activity that contributes to an environmental or social objective, provided that the investment does not significantly harm any environmental or social objective and that the investee companies follow good governance practices.

The EU Taxonomy is a classification system laid down in Regulation (EU) 2020/852, establishing a list of **environmentally sustainable economic activities**. That Regulation does not include a list of socially sustainable economic activities. Sustainable investments with an environmental objective might be aligned with the Taxonomy or not.

Does this financial product have a sustainable investment objective?	
Yes	No
<input type="checkbox"/> It will make a minimum of sustainable investments with an environmental objective: ___% <ul style="list-style-type: none"> <input type="checkbox"/> in economic activities that qualify as environmentally sustainable under the EU Taxonomy <input type="checkbox"/> in economic activities that do not qualify as environmentally sustainable under the EU Taxonomy 	<input checked="" type="checkbox"/> It promotes Environmental/Social (E/S) characteristics and while it does not have as its objective a sustainable investment, it will have a minimum proportion of 10.00% of sustainable investments <ul style="list-style-type: none"> <input checked="" type="checkbox"/> with an environmental objective in economic activities that qualify as environmentally sustainable under the EU Taxonomy <input checked="" type="checkbox"/> with an environmental objective in economic activities that do not qualify as environmentally sustainable under the EU Taxonomy <input checked="" type="checkbox"/> with a social objective
<input type="checkbox"/> It will make a minimum of sustainable investments with a social objective ___%	<input type="checkbox"/> It promotes E/S characteristics, but will not make any sustainable investments



What environmental and/or social characteristics are promoted by this financial product?

Allianz ActiveInvest Dynamic (the "Sub-Fund") promotes a broad range of environmental and/or social characteristics. The Sub-Fund invests at least 70% of its assets following the "Multi Asset Sustainability Strategy" which includes, but is not limited to, various sustainability strategies of the management company and/or, invests in Green Bonds and/or Social Bonds, and/or Sustainability Bonds and/or SFDR Article 8 & 9 Target Funds ("SFDR Target Funds").

Depending on the sustainability strategy selected by the Investment Manager the promoted environmental and/or social characteristics could comprise environmental, social, human rights, governance, business behaviour factors or investments in companies providing solutions that create positive environmental and social outcomes.

In addition, sustainable minimum exclusion criteria apply.

No reference benchmark has been designated for the purpose of attaining the environmental and/or social characteristics promoted by the Sub-Fund.

● What sustainability indicators are used to measure the attainment of each of the environmental or social characteristics promoted by this financial product?

As part of the Multi Asset Sustainability Strategy the Investment Manager allocates at least 70% of Fund's assets in various sustainability approaches.

Sustainability indicators measure how the environmental or social characteristics promoted by the financial product are attained.

To measure the attainment of the environmental and/or social characteristics the following sustainability indicators are used and reported on, at the fiscal year end:

- The actual percentage of the Sub-Fund's assets invested in Green Bonds, and/or Social Bonds, and/or Sustainability Bonds and/or in SFDR Target Funds and/or in Equities and/or Debt Securities in accordance with the Multi Asset Sustainability Strategy.
- In case the Investment Manager decides to directly invest in Debt or Equity Securities as part of the Multi Asset Sustainability Strategy the adherence to the respective binding element will be reported.
- Confirmation that Principal Adverse Impacts (PAIs) of investment decisions on sustainability factors are considered through the application of exclusion criteria (with exception of cash, derivatives, external Target Funds and internal Target Funds not following a sustainability strategy).

● **What are the objectives of the sustainable investments that the financial product partially intends to make and how does the sustainable investment contribute to such objectives?**

Sustainable investments contribute to environmental and/or social objectives, for which the Investment Manager uses as reference frameworks, among others, the UN Sustainable Development Goals (SDGs), as well as the objectives of the EU Taxonomy:

1. Climate Change Mitigation
2. Climate Change Adaptation
3. Sustainable Use and Protection of Water and Marine Resources
4. Transition to a Circular Economy
5. Pollution Prevention and Control
6. Protection and Restoration of Biodiversity and Ecosystems

The assessment of the positive contribution to the environmental or social objectives is based on a proprietary framework which combines quantitative elements with qualitative inputs from internal research. The methodology applies first a quantitative breakdown of a securities issuer into its business activities. The qualitative element of the framework is an assessment if business activities contribute positively to an environmental or a social objective.

To calculate the positive contribution on the Sub-Fund level the revenue share of each issuer attributable to business activities contributing to environmental and/or social objectives is considered provided the issuer is satisfying the Do No Significant Harm ("DNSH") and Good Governance principles, and an asset-weighted aggregation is performed as a second step. Moreover, for certain types of securities, which finance specific projects contributing to environmental or social objectives the overall investment is considered to contribute to environmental and/or social objectives, but also for these a DNSH as well as a Good Governance check for issuers is performed.

● **How do the sustainable investments that the financial product partially intends to make, not cause significant harm to any environmental or social sustainable investment objective?**

In order to ensure that Sustainable Investments do not significantly harm any other environmental and/or social objective, the Investment Manager is leveraging the PAI indicators, whereby significance thresholds have been defined to identify significantly harmful issuers. Issuers not meeting the significance threshold can be engaged for a limited time period to remediate the adverse impact. Otherwise, if the issuer does not meet the defined significance thresholds twice subsequently or in case of a failed engagement, it does not pass the DNSH assessment. Investments in securities of issuers which do not pass the DNSH assessment are not counted as sustainable investments.

● **How have the indicators for adverse impacts on sustainability factors been taken into account?**

All mandatory PAI indicators are considered either as part of the application of the exclusion criteria or through thresholds on a sectorial or absolute basis. Significance thresholds have been defined and they refer to qualitative or quantitative criteria.

Recognizing the lack of data coverage for some of the PAI indicators equivalent data points are used to assess PAI indicators when applying the DNSH assessment, when relevant, for the following indicators for corporates: share of non-renewable energy consumption and production, activities negatively affecting biodiversity-sensitive areas, emissions to water, lack of processes and compliance mechanisms to monitor compliance with UNGC principles and OECD Guidelines for Multinational Enterprises; for sovereigns: GHG Intensity and investee countries subject to social violations. In case of securities which

Principal adverse impacts are the most significant negative impacts of investment decisions on sustainability factors relating to environmental, social and employee matters, respect for human rights, anti-corruption and anti-bribery matters.

finance specific projects contributing to environmental or social objectives equivalent data at project level might be used to ensure that Sustainable Investments do not significantly harm any other environmental and/or social objective. The Investment Manager will strive to increase data coverage for PAI indicators with low data coverage by engaging with issuers and data providers. The Investment Manager will regularly evaluate whether the availability of data has increased sufficiently to potentially include assessment of such data in the investment process.

● *How are the sustainable investments aligned with the OECD Guidelines for Multinational Enterprises and the UN Guiding Principles on Business and Human Rights? Details:*

The Investment Manager's sustainable minimum exclusion list screens out companies based on their involvement in controversial practices against international norms. The core normative framework consists of the Principles of the UN Global Compact, the OECD Guidelines for Multinational Enterprises and the UN Guiding Principles for Business and Human Rights. Securities issued by companies having a severe violation of these frameworks will be restricted from the investment universe.

The EU Taxonomy sets out a "do not significant harm" principle by which Taxonomy-aligned investments should not significantly harm EU Taxonomy objectives and is accompanied by specific EU criteria.

The "do not significant harm" principle applies only to those investments underlying the financial product that take into account the EU criteria for environmentally sustainable economic activities. The investments underlying the remaining portion of this financial product do not take into account the EU criteria for environmentally sustainable economic activities.

Any other sustainable investments must also not significantly harm any environmental or social objectives.



Does this financial product consider principal adverse impacts on sustainability factors?

Yes

No

The Management Company has joined the Net Zero Asset Manager Initiative and considers PAI indicators through stewardship including engagement, both are relevant to mitigate potential adverse impact as a company.

Due to the commitment to the Net Zero Asset Manager Initiative, the Management Company aims to reduce greenhouse gas emissions in partnership with asset owner clients on decarbonisation goals, consistent with an ambition to reach net zero emission by 2050 or sooner across all assets under management. As part of this objective the Management Company will set an interim target for the proportion of assets to be managed in line with the attainment of net zero emissions by 2050 or sooner.

The Sub-Fund's Investment Manager addresses PAI indicators regarding greenhouse gas emission, biodiversity, water, waste as well as social and employee matters for corporate issuers, and, where relevant, the freedom house index is applied to investments in sovereigns. PAI indicators are considered within the Investment Manager's investment process through the means of exclusions as described in the "binding elements" section of the Sub-Fund.

The data coverage for the data required for the PAI indicators is heterogenous. The data coverage related to biodiversity, water and waste is low and the related PAI indicators are considered through exclusion of securities issued by companies having a severe violation / breach of principles and guidelines such as the Principles of the United Nations Global Compact, the OECD Guidelines for Multinational Enterprises, and the United Nations Guiding Principles for Business and Human Rights on the grounds of problematic practices around human rights, labour rights, environment, and corruption issues. Therefore, the Investment Manager will strive to increase data coverage for PAI indicators with low data coverage. The Investment Manager will regularly evaluate whether the availability of data has increased sufficiently to potentially include assessment of such data in the investment process.

The following PAI indicators are considered:

Applicable to corporate issuers

- GHG Emissions
- Carbon footprint
- GHG Intensity of investee companies
- Exposure to companies active in the fossil fuel sector

- Activities negatively affecting biodiversity-sensitive areas
- Emissions to water
- Hazardous waste ratio
- Violation of UN Global compact principles
- Lack of processes and compliance mechanisms to monitor compliance with UN Global Compact principles
- Board gender diversity
- Exposure to controversial weapons

Applicable to sovereign and supranational issuers

- Investee countries subject to social violations

The information on the PAI indicators will be available in the end-year report of the Sub-Fund.



What investment strategy does this financial product follow?

The investment strategy guides investment decisions based on factors such as investment objectives and risk tolerance.

Allianz ActiveInvest Dynamic's investment objective is to invest in a broad range of asset classes, in particular in the global bond-, equity-, alternative- and money markets. The Sub-Fund achieves its investment objective by investing in investment funds (including internal SFDR Target Funds) with different regional focuses from a global investment universe. Overall, the goal is to achieve over the medium-term a performance comparable to a dynamic portfolio consisting of global Equity Markets and Euro Bond Markets. The assessment of the volatility of the capital markets by the Investment Manager is an important factor in this process, with the aim of typically not falling below or exceeding a volatility of the Share price within a range of 10% to 18% on a medium to long-term average. A Sub-Fund managed according to the Multi Asset Sustainability Strategy ("MAS Strategy") invests in (i) Equities and / or Debt Securities of companies that either provide for environmental and/or social characteristics and/or pursue activities contributing to an environmental or social objective and / or invests (ii) in Green Bonds and/or Social Bonds, and/or in Sustainability Bonds and/or (iii) in SFDR Target Funds.

In case of direct investments in Equities and/or Debt Securities, the Sub-Fund's Investment Manager may choose one or more of the below strategies that promote environmental and/or social characteristics and/or pursue activities contributing to an environmental or social objective:

- SRI Strategy

The Sub-Fund or strategy promotes environmental and social characteristics through integrating environmental, social, human rights, governance and business behaviour factors into the Sub-Fund's investment process through a best-in-class approach. This encompasses the evaluation of corporate or sovereign issuers based on an SRI Rating that it is used to construct the portfolio.

- Climate Engagement with Outcome Strategy

The Sub-Fund or strategy promotes environmental characteristics through the engagement with the top 10 carbon emitting issuers to encourage their transition pathway to a low carbon economy by setting objectives which are sector specific.

- SDG-Aligned & SDG-Aligned Type A Strategy

The Sub-Fund's or strategy's Sustainable Investment objective is to invest in Equities and/or in Debt Securities of companies providing solutions that create positive environmental and social outcomes, as assessed by the contribution of companies' outputs to the attainment of one or more of the SDGs or other Sustainable Investment objectives, which the Sub-Fund's Investment Manager may additionally determine and to which the companies contribute to.

- Green Bond Strategy

The Sub-Fund's or strategy's Sustainable Investment objective is to mobilize capital markets towards the transition to a low carbon society, natural capital preservation and adaptation to climate change. The Sub-Fund or strategy invests primarily in Green Bonds financing climate change mitigation or adaptation projects or other environmental sustainability projects, notably in the following fields: energy efficiency, renewable energy, raw materials, water and land, waste management, greenhouse gas emissions reduction, biodiversity preservation or circular economy.

- Green Transition Strategy

The Sub-Fund or strategy promotes environmental and/or social characteristics through the mobilization of capital markets towards the transition to a low carbon society, natural capital preservation and adaptation to climate change.

- KPI Strategy (Absolute)

A Sub-Fund or strategy managed according to the Sustainability Key Performance Indicator Strategy (Absolute) ("KPI Strategy (Absolute)") promotes environmental objectives by applying an investment objective related to an environmental key performance indicator referred to as "Sustainability KPI" to provide transparency on the measurable sustainability outcome pursued. The "Sustainability KPI" to be measured is the GHG Intensity defined by the Weighted Average GHG Intensity (Sales) of issuers included in the Fund's portfolio. GHG Intensity will be addressed by ensuring a pre-determined year-on-year improvement pathway of the weighted average GHG Intensity on Fund's portfolio level at the Fund's fiscal year ends.

- KPI Strategy (Relative)

A Sub-Fund or strategy managed according to the Sustainability Key Performance Indicator Strategy (Relative) ("KPI Strategy (Relative)") promotes environmental objectives by applying an investment objective related to an environmental key performance indicator referred to as "Sustainability KPI" to provide transparency on the measurable sustainability outcome pursued. The "Sustainability KPI" to be measured is the GHG Intensity of issuers acquired by the Fund defined by the Weighted Average GHG Intensity (Sales). GHG Intensity of the Fund will be addressed by outperforming the Fund's benchmark (respectively the Weighted Average GHG Intensity of the issuers included in the Fund's benchmark) in terms of Weighted Average GHG Intensity.

- ESG Score Strategy

A Sub-Fund or strategy managed according to the ESG Score Strategy promotes Environment, Social and Governance factors through the ESG Score Strategy. The ESG Score Strategy aims to measure a company's resilience to long-term risks across the three pillars of Environment, Social and Governance. ESG pillars will be addressed by outperforming the Weighted Average ESG Score of issuers whose shares have been acquired by the Fund against the Weighted Average ESG Score of issuers which are components of Fund's benchmark.

- KPI Strategy (Absolute Threshold)

A Sub-Fund or strategy managed according to the Sustainability Key Performance Indicator Strategy (Absolute Threshold) ("KPI Strategy (Absolute Threshold)") targets a specific minimum allocation into Sustainable Investments. Sustainable investments are investments in economic activities which contribute to environmental and/or social objectives, for which the Investment Managers uses as reference frameworks the UN Sustainable Development Goals (SDGs), as well as the objectives of the EU Taxonomy.

The Sub-Fund's general investment approach (Sub-Fund's applicable General Asset Class Principles in combination with its individual investment restrictions) is described in the prospectus.

● **What are the binding elements of the investment strategy used to select the investments to attain each of the environmental or social characteristics promoted by this financial product?**

A Sub-Fund managed according to the Multi Asset Sustainability Strategy ("MAS Strategy") invests in (i) Equities and / or Debt Securities of companies that either provide for environmental and/or social characteristics and/or pursue activities contributing to an environmental or social objective and / or invests (ii) in Green Bonds and/or Social Bonds, and/or in Sustainability Bonds and/or (iii) in SFDR Target Funds.

Overall, the Investment Manager is required to invest min 70% of Sub-Fund's assets in SFDR Target Funds and/or in Equities and/or Debt Securities in accordance with the Multi Asset Sustainability Strategy.

- Application of the following sustainable minimum exclusion criteria for direct investments (with exception of cash, derivatives, external Target Funds, and internal Target Funds not following a sustainable strategy):
- securities issued by companies having a severe violation / breach of principles and guidelines such as the Principles of the United Nations Global Compact, the OECD Guidelines for Multinational Enterprises, and the United Nations Guiding Principles for Business and Human Rights on the grounds of problematic practices around human rights, labour rights, environment, and corruption issues,
- securities issued by companies involved in controversial weapons (anti-personnel mines, cluster munitions, chemical weapons, biological weapons, depleted uranium, white phosphorus, and nuclear weapons),
- securities issued by companies that derive more than 10% of their revenues from weapons, military equipment, and services,

- securities issued by companies that derive more than 10% of their revenue from thermal coal extraction,
- securities issued by utility companies that generate more than 20% of their revenues from coal,
- securities issued by companies involved in the production of tobacco, and securities issued by companies involved in the distribution of tobacco with more than 5% of their revenues.

Direct investments in sovereign issuers with an insufficient freedom house index score are excluded.

The sustainable minimum exclusion criteria are based on information from an external data provider and coded in pre- and post-trade compliance. The review is performed at least half yearly.

● **What is the committed minimum rate to reduce the scope of the investments considered prior to the application of that investment strategy?**

The Sub-Fund does not commit to reduce the scope of the investments by a certain minimum rate.

● **What is the policy to assess good governance practices of the investee companies?**

Good governance principles are considered by screening out companies based on their involvement in controversies around international norms corresponding to the four good governance practices: sound management structures, employee relations, remuneration of staff and tax compliance. Companies having a severe violation in either of those areas will not be investible. For certain cases, flagged issuers shall be on a watch list. These companies will appear on this watch list when the Investment Manager believes that engagement may lead to improvements or when the company is assessed to take remedial actions. Companies on the watch list remain investible unless the Investment Manager believes that the engagement or the remedial actions of the company does not lead to the desired remedy of the severe controversy.

In addition, the Sub-Fund's Investment Manager is committed to actively encourage open dialogues with investee companies on corporate governance, proxy voting and broader sustainability issues in advance of shareholder meetings (regularly for direct investments in shares). The Sub-Fund's Investment Manager's approach to proxy voting and company engagement is set out in the Management Company's Stewardship Statement.

Good governance practices include sound management structures, employee relations, remuneration of staff and tax compliance.



What is the asset allocation planned for this financial product?

Asset allocation describes the share of investments in specific assets.

Min. 70% of the Sub-Funds' assets are used to meet the environmental or social characteristics promoted by this Sub-Fund. A low portion of the Sub-Fund might contain assets which do not promote environmental or social characteristics. Example of such instruments are derivatives, cash and deposits, some Target Funds and investment with temporarily divergent or absent environmental, social, or good governance qualifications or investments outside of the specified quota to be invested as part of the Multi Asset Sustainability Strategy. Min. 10% of the Sub-Funds' assets will be invested in Sustainable Investments. The minimum percentage of investments that are aligned with the EU Taxonomy is 0.01%. The Sub-Fund's Investment Manager does not commit to a minimum share of environmentally Sustainable Investments that are not aligned with the EU Taxonomy. The Sub-Fund's Investment Manager does not commit to a minimum share of socially sustainable investments. While the Sub-Fund cannot commit to a minimum share of environmentally or socially sustainable investments, such investments may be freely allocated to within the Sub-Fund aggregated sustainable investment commitment disclosed (min.10%).

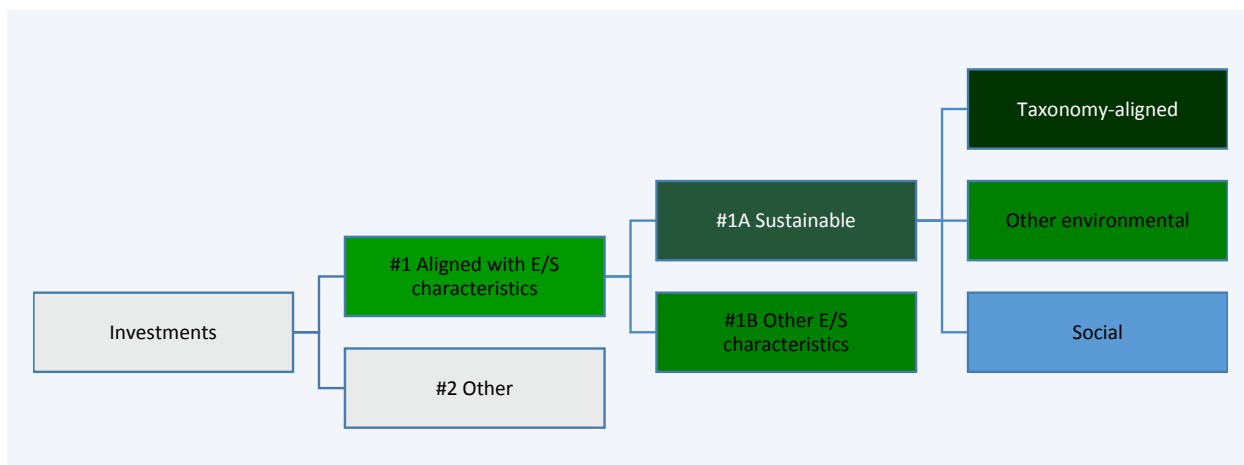

#1 Aligned with E/S characteristics includes the investments of the financial product used to attain the environmental or social characteristics promoted by the financial product.

#2 Other includes the remaining investments of the financial product which are neither aligned with the environmental or social characteristics, nor are qualified as sustainable investments.

The category **#1 Aligned with E/S characteristics** covers:

- The sub-category **#1A Sustainable** covers sustainable investments with environmental or social objectives.
- The sub-category **#1B Other E/S characteristics** covers investments aligned with the environmental or social characteristics that do not qualify as sustainable investments.

- **How does the use of derivatives attain the environmental or social characteristics promoted by the financial product?**

Not applicable



To what minimum extent are sustainable investments with an environmental objective aligned with the EU Taxonomy?

The Taxonomy-aligned investments include debt and/or equity in environmentally sustainable economic activities aligned with the EU-Taxonomy. The minimum percentage of investments that are aligned with the EU Taxonomy is 0.01%. Taxonomy-aligned data is provided by an external data provider. The Investment Manager has assessed the quality of such data. The data will not be subject to an assurance provided by auditors or a review by third parties. The data will not reflect any data in government bonds. As of today, there is no recognized methodology available to determine the proportion of Taxonomy-aligned activities when investing in government bonds.

Taxonomy-aligned activities in this disclosure are based on share of turnover. Pre-contractual figures use turnover as its financial metric as a default in line with the regulatory requirements and based on the fact that complete, verifiable or up-to date data for CAPEX and/or OPEX as financial metric is even less available.

Taxonomy-aligned data is only in rare cases data reported by companies in accordance with the EU Taxonomy. The data provider has derived Taxonomy-aligned data from other available equivalent public data.

- **Does the financial product invest in fossil gas and/or nuclear energy related activities that comply with the EU Taxonomy ¹?**

Yes:

In fossil gas In nuclear energy

No

The Sub-Fund does not pursue any investments in fossil gas and/or nuclear energy related activities that comply with the EU Taxonomy. Nevertheless, as result of this investment strategy, investments may occur in corporates which are also active in these activities. Further information will be provided as part of the annual reporting, if relevant.

Taxonomy-aligned activities are expressed as a share of:

- **turnover** reflecting the share of revenue from green activities of investee companies
- **capital expenditure (CapEx)** showing the green investments made by investee companies, e.g. for a transition to a green

¹ Fossil gas and/or nuclear related activities will only comply with the EU Taxonomy where they contribute to limiting climate change ("climate change mitigation") and do not significantly harm any EU Taxonomy objective - see explanatory note in the left hand margin. The full criteria for fossil gas and nuclear energy economic activities that comply with the EU Taxonomy are laid down in Commission Delegated Regulation (EU) 2022/1214.

economy.
 - **operational expenditure (OpEx)** reflecting green operational activities of investee companies.

The two graphs below show in green the minimum percentage of investments that are aligned with the EU Taxonomy. As there is no appropriate methodology to determine the Taxonomy-alignment of sovereign bonds*, the first graph shows the Taxonomy-alignment in relation to all the investments of the financial product including sovereign bonds, while the second graph shows the Taxonomy-alignment only in relation to the investments of the financial product other than sovereign bonds.

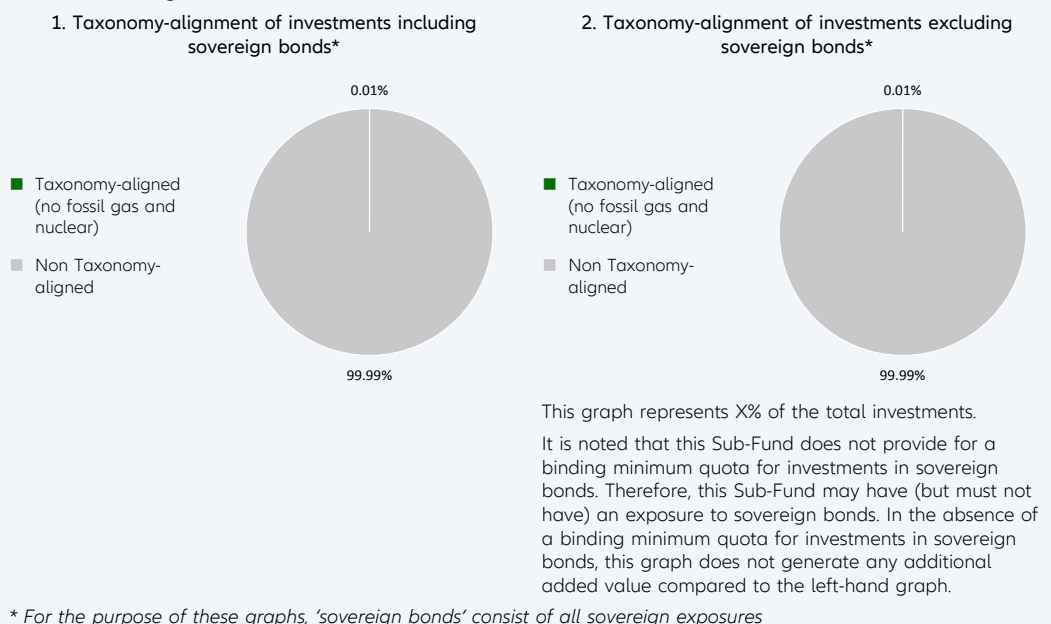

Enabling activities directly enable other activities to make a substantial contribution to an environmental objective.

● **What is the minimum share of investments in transitional and enabling activities?**

The Sub-Fund's Investment Manager does not commit to a split of minimum taxonomy alignment into transitional, enabling activities and own performance.

Transitional activities are activities for which low-carbon alternatives are not yet available and among others have greenhouse gas emission levels corresponding to the best performance.



What is the minimum share of sustainable investments with an environmental objective that are not aligned with the EU Taxonomy?

Taxonomy-aligned investments are considered a sub-category of Sustainable Investments. If an investment is not Taxonomy-aligned since the activity is not yet covered under the EU Taxonomy or the positive contribution is not substantial enough to comply with the Taxonomy technical screening criteria, the investment can still be considered an environmentally Sustainable Investment provided it complies with all criteria. The Investment Manager does not commit to a minimum share of environmentally Sustainable Investments that are not aligned with the EU Taxonomy. The overall sustainable investment share may also include investments with an environmental objective in economic activities that do not qualify as environmentally sustainable under the EU Taxonomy, and while the Sub-Fund cannot commit to a minimum share of environmentally or socially sustainable investments, such investments may be freely allocated to within the Sub-Fund aggregated sustainable investment commitment disclosed (min 10%).

are sustainable investments with an environmental objective that **do not take into account the criteria** for environmentally sustainable economic activities under the EU Taxonomy.



What is the minimum share of socially sustainable investments?

The Investment Manager defines Sustainable Investments based on internal research, which uses, among others, the UN Sustainable Development Goals (SDGs), as well as the objectives of the EU Taxonomy as reference frameworks. The Investment Manager does not commit to a minimum share of socially Sustainable Investments, as the SDGs contain environmental as well as social objectives. The overall sustainable investment share may also include investments with a social objective, and while the Sub-Fund cannot commit to a minimum share of environmentally or socially sustainable investments, such investments may be freely allocated to within the Sub-Fund aggregated sustainable investment commitment disclosed (min 10%).



What investments are included under “#2 Other”, what is their purpose and are there any minimum environmental or social safeguards?

Under “#2 Other” investments into cash, Target Funds, or derivatives can be included. Derivatives might be used for efficient portfolio management (including risk hedging) and/or investment purposes, and Target Funds to benefit from a specific strategy. For those investments no environmental or social safeguards are applied.



Is a specific index designated as a reference benchmark to determine whether this financial product is aligned with the environmental and/or social characteristics that it promotes?

No reference benchmark has been designated for the purpose of attaining the environmental and/or social characteristics promoted by the Sub-Fund.

- How is the reference benchmark continuously aligned with each of the environmental or social characteristics promoted by the financial product?

Not applicable

- How is the alignment of the investment strategy with the methodology of the index ensured on a continuous basis?

Not applicable

- How does the designated index differ from a relevant broad market index?

Not applicable

- Where can the methodology used for the calculation of the designated index be found?

Not applicable



Where can I find more product specific information online?

More product-specific information can be found on the website: <https://regulatory.allianzgi.com/SFDR>

Reference benchmarks are indexes to measure whether the financial product attains the environmental or social characteristics that they promote.

Template pre-contractual disclosure for the financial products referred to in Article 8, paragraphs 1, 2 and 2a, of Regulation (EU) 2019/2088 and Article 6, first paragraph, of Regulation (EU) 2020/852

Product name:

Allianz Advanced Fixed Income Euro

Legal entity identifier: 529900W7WKKWPZ6I8386

Environmental and/or social characteristics

Sustainable investment means an investment in an economic activity that contributes to an environmental or social objective, provided that the investment does not significantly harm any environmental or social objective and that the investee companies follow good governance practices.

The **EU Taxonomy** is a classification system laid down in Regulation (EU) 2020/852, establishing a list of **environmentally sustainable economic activities**. That Regulation does not include a list of socially sustainable economic activities. Sustainable investments with an environmental objective might be aligned with the Taxonomy or not.

Does this financial product have a sustainable investment objective?	
<input checked="" type="radio"/> <input checked="" type="radio"/> Yes	<input checked="" type="radio"/> <input type="radio"/> No
<input type="checkbox"/> It will make a minimum of sustainable investments with an environmental objective: ___% <ul style="list-style-type: none"> <input type="checkbox"/> in economic activities that qualify as environmentally sustainable under the EU Taxonomy <input type="checkbox"/> in economic activities that do not qualify as environmentally sustainable under the EU Taxonomy 	<input checked="" type="checkbox"/> It promotes Environmental/Social (E/S) characteristics and while it does not have as its objective a sustainable investment, it will have a minimum proportion of 2.00% of sustainable investments <ul style="list-style-type: none"> <input checked="" type="checkbox"/> with an environmental objective in economic activities that qualify as environmentally sustainable under the EU Taxonomy <input checked="" type="checkbox"/> with an environmental objective in economic activities that do not qualify as environmentally sustainable under the EU Taxonomy <input checked="" type="checkbox"/> with a social objective
<input type="checkbox"/> It will make a minimum of sustainable investments with a social objective ___%	<input type="checkbox"/> It promotes E/S characteristics, but will not make any sustainable investments



What environmental and/or social characteristics are promoted by this financial product?

Allianz Advanced Fixed Income Euro (the "Sub-Fund") promotes environmental, social, human rights, governance, and business behaviour factors (this domain does not apply for sovereigns issued by a Sovereign Entity) through integration of a best-in-class approach into the Sub-Fund's investment process. This encompasses the evaluation of corporate or sovereign issuers based on an SRI Rating which is used to construct the portfolio.

In addition, sustainable minimum exclusion criteria apply.

No reference benchmark has been designated for the purpose of attaining the environmental and/or social characteristics promoted by the Sub-Fund.

● What sustainability indicators are used to measure the attainment of each of the environmental or social characteristics promoted by this financial product?

To measure the attainment of the environmental and/or social characteristics the following sustainability indicators are used and reported on, at the fiscal year end:

- The actual percentage of the Sub-Fund's Portfolio (Portfolio in this respect does not comprise non-rated derivatives and instruments that are non-rated by nature (e. g., cash and deposits)) assets invested in best-in-class issuers (issuers with a minimum SRI Rating of 1 out of a scale from 0-4; 0 being the worst rating and 4 the best rating) is compared to the actual percentage of the benchmarks best-in-class issuers.
- Confirmation that Principal Adverse Impacts (PAIs) of investment decisions on sustainability factors are considered through the application of exclusion criteria.

Sustainability indicators measure how the environmental or social characteristics promoted by the financial product are attained.

● **What are the objectives of the sustainable investments that the financial product partially intends to make and how does the sustainable investment contribute to such objectives?**

Sustainable investments contribute to environmental and/or social objectives, for which the Investment Manager uses as reference frameworks, among others, the UN Sustainable Development Goals (SDGs), as well as the objectives of the EU Taxonomy:

1. Climate Change Mitigation
2. Climate Change Adaptation
3. Sustainable Use and Protection of Water and Marine Resources
4. Transition to a Circular Economy
5. Pollution Prevention and Control
6. Protection and Restoration of Biodiversity and Ecosystems

The assessment of the positive contribution to the environmental or social objectives is based on a proprietary framework which combines quantitative elements with qualitative inputs from internal research. The methodology applies first a quantitative breakdown of a securities issuer into its business activities. The qualitative element of the framework is an assessment if business activities contribute positively to an environmental or a social objective.

To calculate the positive contribution on the Sub-Fund level the revenue share of each issuer attributable to business activities contributing to environmental and/or social objectives is considered provided the issuer is satisfying the Do No Significant Harm (“DNSH”) and Good Governance principles, and an asset-weighted aggregation is performed as a second step. Moreover, for certain types of securities, which finance specific projects contributing to environmental or social objectives the overall investment is considered to contribute to environmental and/or social objectives, but also for these a DNSH as well as a Good Governance check for issuers is performed.

● **How do the sustainable investments that the financial product partially intends to make, not cause significant harm to any environmental or social sustainable investment objective?**

In order to ensure that Sustainable Investments do not significantly harm any other environmental and/or social objective, the Investment Manager is leveraging the PAI indicators, whereby significance thresholds have been defined to identify significantly harmful issuers. Issuers not meeting the significance threshold can be engaged for a limited time period to remediate the adverse impact. Otherwise, if the issuer does not meet the defined significance thresholds twice subsequently or in case of a failed engagement, it does not pass the DNSH assessment. Investments in securities of issuers which do not pass the DNSH assessment are not counted as sustainable investments.

● *How have the indicators for adverse impacts on sustainability factors been taken into account?*

All mandatory PAI indicators are considered either as part of the application of the exclusion criteria or through thresholds on a sectorial or absolute basis. Significance thresholds have been defined and they refer to qualitative or quantitative criteria.

Recognizing the lack of data coverage for some of the PAI indicators equivalent data points are used to assess PAI indicators when applying the DNSH assessment, when relevant, for the following indicators for corporates: share of non-renewable energy consumption and production, activities negatively affecting biodiversity-sensitive areas, emissions to water, lack of processes and compliance mechanisms to monitor compliance with UNGC principles and OECD Guidelines for Multinational Enterprises; for sovereigns: GHG Intensity and investee countries subject to social violations. In case of securities which finance specific projects contributing to environmental or social objectives equivalent data at project level might be used to ensure that Sustainable Investments do not significantly harm any other environmental and/or social objective. The Investment Manager will strive to increase data coverage for PAI indicators with low data coverage by engaging with issuers and data providers. The Investment Manager will regularly evaluate whether the availability of data has increased sufficiently to potentially include assessment of such data in the investment process.

● *How are the sustainable investments aligned with the OECD Guidelines for Multinational Enterprises and the UN Guiding Principles on Business and Human Rights? Details:*

The Investment Manager’s sustainable minimum exclusion list screens out companies based on their involvement in controversial practices against international norms. The core normative framework consists of the Principles of the UN Global Compact, the OECD Guidelines for Multinational Enterprises

Principal adverse impacts are the most significant negative impacts of investment decisions on sustainability factors relating to environmental, social and employee matters, respect for human rights, anti-corruption and anti-bribery matters.

and the UN Guiding Principles for Business and Human Rights. Securities issued by companies having a severe violation of these frameworks will be restricted from the investment universe.

The EU Taxonomy sets out a “do not significant harm” principle by which Taxonomy-aligned investments should not significantly harm EU Taxonomy objectives and is accompanied by specific EU criteria.

The “do not significant harm” principle applies only to those investments underlying the financial product that take into account the EU criteria for environmentally sustainable economic activities. The investments underlying the remaining portion of this financial product do not take into account the EU criteria for environmentally sustainable economic activities.

Any other sustainable investments must also not significantly harm any environmental or social objectives.



Does this financial product consider principal adverse impacts on sustainability factors?

Yes

No

The Management Company has joined the Net Zero Asset Manager Initiative and considers PAI indicators through stewardship including engagement, both are relevant to mitigate potential adverse impact as a company.

Due to the commitment to the Net Zero Asset Manager Initiative, the Management Company aims to reduce greenhouse gas emissions in partnership with asset owner clients on decarbonisation goals, consistent with an ambition to reach net zero emission by 2050 or sooner across all assets under management. As part of this objective the Management Company will set an interim target for the proportion of assets to be managed in line with the attainment of net zero emissions by 2050 or sooner.

The Sub-Fund’s Investment Manager considers PAI indicators regarding greenhouse gas emission, biodiversity, water, waste as well as social and employee matters for corporate issuers, and, where relevant, the freedom house index is applied to investments in sovereigns. PAI indicators are considered within the Investment Manager’s investment process through the means of exclusions as described in the “binding elements” section of the Sub-Fund.

The data coverage for the data required for the PAI indicators is heterogenous. The data coverage related to biodiversity, water and waste is low and the related PAI indicators are considered through exclusion of securities issued by companies having a severe violation / breach of principles and guidelines such as the Principles of the United Nations Global Compact, the OECD Guidelines for Multinational Enterprises, and the United Nations Guiding Principles for Business and Human Rights on the grounds of problematic practices around human rights, labour rights, environment, and corruption issues. Therefore, the Investment Manager will strive to increase data coverage for PAI indicators with low data coverage. The Investment Manager will regularly evaluate whether the availability of data has increased sufficiently to potentially include assessment of such data in the investment process.

Additionally, PAI indicators are, among other sustainability factors, applied to derive the SRI Rating. The SRI Rating is used for the portfolio construction.

The following PAI indicators are considered:

Applicable to corporate issuers

- GHG Emissions
- Carbon footprint
- GHG Intensity of investee companies
- Exposure to companies active in the fossil fuel sector
- Activities negatively affecting biodiversity-sensitive areas
- Emissions to water
- Hazardous waste ratio
- Violation of UN Global compact principles
- Lack of processes and compliance mechanisms to monitor compliance with UN Global Compact principles
- Board gender diversity
- Exposure to controversial weapons

Applicable to sovereign and supranational issuers

- Investee countries subject to social violations

The information on the PAI indicators will be available in the end-year report of the Sub-Fund.



The investment strategy guides investment decisions based on factors such as investment objectives and risk tolerance.

What investment strategy does this financial product follow?

Allianz Advanced Fixed Income Euro's investment objective is to invest in global Bond Markets with Euro exposure in accordance with the Sustainable and Responsible Investment Strategy (SRI Strategy).

As part of the SRI best-in-class approach, the Sub-Fund takes environmental, social, human rights, governance, and business behaviour factors into account as follows:

- The aforesaid sustainability factors are analysed through SRI Research by the Investment Manager in order to assess how sustainable development and long-term issues are taken into account in the strategy of an issuer. SRI Research means the overall process of identifying potential risks as well as potential opportunities of an investment in securities of an issuer related to the analysis of sustainability factors. SRI Research data combines external research data (which might have some limitations) with internal analyses.
- Based on a combination of the results of the external and/or internal analyses of the sustainability factors, an internal rating is derived monthly (SRI Rating) and is afterwards assigned to a corporate or sovereign issuer.

This internal SRI Rating is used to rank and select or weight securities for the portfolio construction.

The Sub-Fund's general investment approach (Sub-Fund's applicable General Asset Class Principles in combination with its individual investment restrictions) is described in the prospectus.

● What are the binding elements of the investment strategy used to select the investments to attain each of the environmental or social characteristics promoted by this financial product?

The binding elements are:

- Minimum rating coverage: At least 90% of the Sub-Fund's portfolio is required to have an SRI Rating (portfolio in this respect does not comprise non-rated derivatives and instruments that are non-rated by nature e.g., cash and deposits). While most holdings of the Sub-Fund will have a corresponding SRI Rating some investments cannot be rated according to the SRI Research methodology. Examples of instruments not attaining to the SRI Rating include, but are not limited to cash, deposits, Target Funds, and non-rated investments.
- The rated instruments are adhering to the minimum rating threshold of 1 (out of a rating scale from 0 – 4; 0 being the worst rating and 4 the best rating).
- Application of the following sustainable minimum exclusion criteria for direct investments:
 - securities issued by companies having a severe violation / breach of principles and guidelines such as the Principles of the United Nations Global Compact, the OECD Guidelines for Multinational Enterprises, and the United Nations Guiding Principles for Business and Human Rights on the grounds of problematic practices around human rights, labour rights, environment, and corruption issues,
 - securities issued by companies involved in controversial weapons (anti-personnel mines, cluster munitions, chemical weapons, biological weapons, depleted uranium, white phosphorus, and nuclear weapons),
 - securities issued by companies that derive more than 10% of their revenues from weapons, military equipment, and services,
 - securities issued by companies that derive more than 10% of their revenue from thermal coal extraction,
 - securities issued by utility companies that generate more than 20% of their revenues from coal,
 - securities issued by companies involved in the production of tobacco, and securities issued by companies involved in the distribution of tobacco with more than 5% of their revenues.

Direct investments in sovereign issuers with an insufficient freedom house index score are excluded.

The sustainable minimum exclusion criteria are based on information from an external data provider and coded in pre- and post-trade compliance. The review is performed at least half yearly.

- **What is the committed minimum rate to reduce the scope of the investments considered prior to the application of that investment strategy?**

The Sub-Fund does not commit to reduce the scope of the investments by a certain minimum rate.

- **What is the policy to assess good governance practices of the investee companies?**

Good governance principles are considered by screening out companies based on their involvement in controversies around international norms corresponding to the four good governance practices: sound management structures, employee relations, remuneration of staff and tax compliance. Companies having a severe violation in either of those areas will not be investible. For certain cases, flagged issuers shall be on a watch list. These companies will appear on this watch list when the Investment Manager believes that engagement may lead to improvements or when the company is assessed to take remedial actions. Companies on the watch list remain investible unless the Investment Manager believes that the engagement or the remedial actions of the company does not lead to the desired remedy of the severe controversy.

In addition, the Sub-Fund's Investment Manager is committed to actively encourage open dialogues with investee companies on corporate governance, proxy voting and broader sustainability issues in advance of shareholder meetings (regularly for direct investments in shares). The Sub-Fund's Investment Manager's approach to proxy voting and company engagement is set out in the Management Company's Stewardship Statement.

Good governance practices include sound management structures, employee relations, remuneration of staff and tax compliance.



What is the asset allocation planned for this financial product?

Asset allocation describes the share of investments in specific assets.

Min. 90% of the Sub-Funds' assets (excluding cash and non-rated derivatives) are used to meet the environmental or social characteristics promoted by this Sub-Fund. A low portion of the Sub-Fund might contain assets which do not promote environmental or social characteristics. Examples of such instruments are derivatives, cash and deposits, some Target Funds and investment with temporarily divergent or absent environmental, social, or good governance qualifications. Min. 2% of the Sub-Funds' assets will be invested in Sustainable Investments. The minimum percentage of investments that are aligned with the EU Taxonomy is 0.01%. The Sub-Fund's Investment Manager does not commit to a minimum share of environmentally Sustainable Investments that are not aligned with the EU Taxonomy. The Sub-Fund's Investment Manager does not commit to a minimum share of socially sustainable investments. While the Sub-Fund cannot commit to a minimum share of environmentally or socially sustainable investments, such investments may be freely allocated to within the Sub-Fund aggregated sustainable investment commitment disclosed (min. 2%).

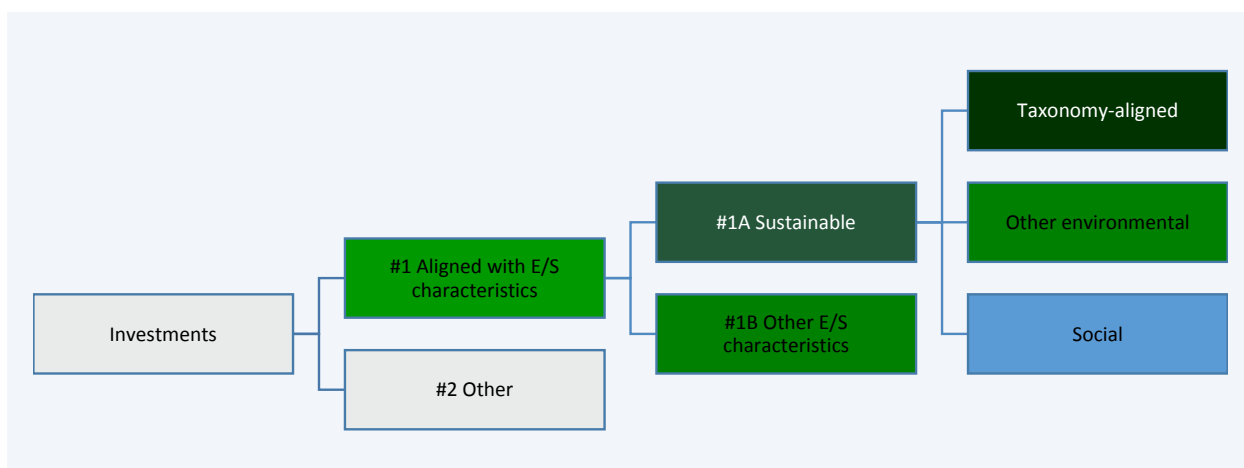

#1 Aligned with E/S characteristics includes the investments of the financial product used to attain the environmental or social characteristics promoted by the financial product.

#2 Other includes the remaining investments of the financial product which are neither aligned with the environmental or social characteristics, nor are qualified as sustainable investments.

The category **#1 Aligned with E/S characteristics** covers:

- The sub-category **#1A Sustainable** covers sustainable investments with environmental or social objectives.
- The sub-category **#1B Other E/S characteristics** covers investments aligned with the environmental or social characteristics that do not qualify as sustainable investments.

- **How does the use of derivatives attain the environmental or social characteristics promoted by the financial product?**

Not applicable



To what minimum extent are sustainable investments with an environmental objective aligned with the EU Taxonomy?

The Taxonomy-aligned investments include debt and/or equity in environmentally sustainable economic activities aligned with the EU-Taxonomy. The minimum percentage of investments that are aligned with the EU Taxonomy is 0.01%. Taxonomy-aligned data is provided by an external data provider. The Investment Manager has assessed the quality of such data. The data will not be subject to an assurance provided by auditors or a review by third parties. The data will not reflect any data in government bonds. As of today, there is no recognized methodology available to determine the proportion of Taxonomy-aligned activities when investing in government bonds.

Taxonomy-aligned activities in this disclosure are based on share of turnover. Pre-contractual figures use turnover as its financial metric as a default in line with the regulatory requirements and based on the fact that complete, verifiable or up-to date data for CAPEX and/or OPEX as financial metric is even less available.

Taxonomy-aligned data is only in rare cases data reported by companies in accordance with the EU Taxonomy. The data provider has derived Taxonomy-aligned data from other available equivalent public data.

- **Does the financial product invest in fossil gas and/or nuclear energy related activities that comply with the EU Taxonomy¹?**

- Yes:
 - In fossil gas
 - In nuclear energy
- No

The Sub-Fund does not pursue any investments in fossil gas and/or nuclear energy related activities that comply with the EU Taxonomy. Nevertheless, as result of this investment strategy, investments may occur in corporates which are also active in these activities. Further information will be provided as part of the annual reporting, if relevant.

The two graphs below show in green the minimum percentage of investments that are aligned with the EU Taxonomy. As there is no appropriate methodology to determine the Taxonomy-alignment of sovereign bonds, the first graph shows the Taxonomy-alignment in relation to all the investments of the financial product including sovereign bonds, while the second graph shows the Taxonomy-alignment only in relation to the investments of the financial product other than sovereign bonds.*

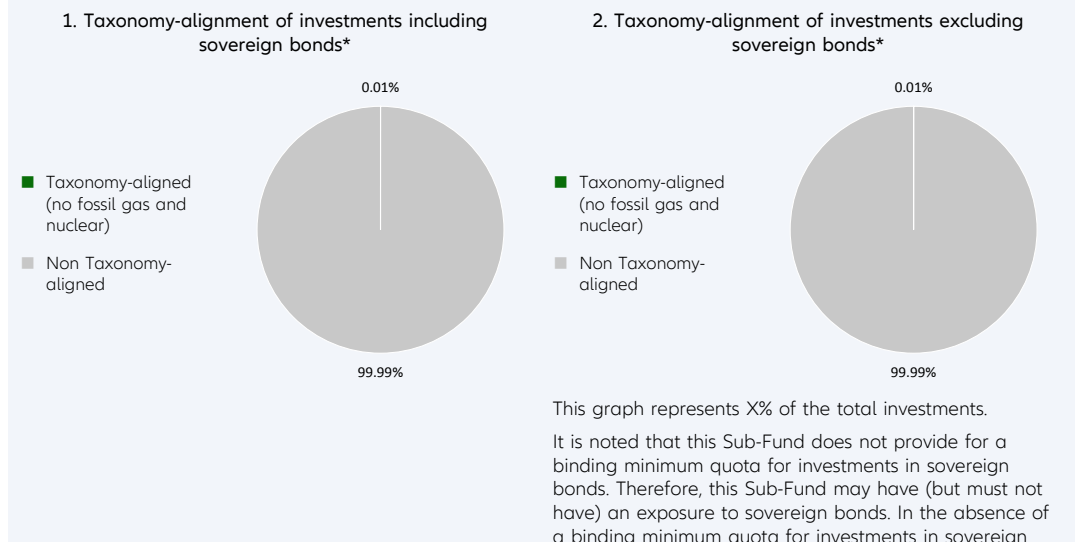

Taxonomy-aligned activities are expressed as a share of:

- **turnover** reflecting the share of revenue from green activities of investee companies
- **capital expenditure (CapEx)** showing the green investments made by investee companies, e.g. for a transition to a green economy.
- **operational expenditure (OpEx)** reflecting green operational activities of investee companies.

¹ Fossil gas and/or nuclear related activities will only comply with the EU Taxonomy where they contribute to limiting climate change ("climate change mitigation") and do not significantly harm any EU Taxonomy objective - see explanatory note in the left hand margin. The full criteria for fossil gas and nuclear energy economic activities that comply with the EU Taxonomy are laid down in Commission Delegated Regulation (EU) 2022/1214.

bonds, this graph does not generate any additional added value compared to the left-hand graph.

* For the purpose of these graphs, 'sovereign bonds' consist of all sovereign exposures

Enabling activities directly enable other activities to make a substantial contribution to an environmental objective.

Transitional activities are activities for which low-carbon alternatives are not yet available and among others have greenhouse gas emission levels corresponding to the best performance.

● **What is the minimum share of investments in transitional and enabling activities?**

The Sub-Fund's Investment Manager does not commit to a split of minimum taxonomy alignment into transitional, enabling activities and own performance.



What is the minimum share of sustainable investments with an environmental objective that are not aligned with the EU Taxonomy?

Taxonomy-aligned investments are considered a sub-category of Sustainable Investments. If an investment is not Taxonomy-aligned since the activity is not yet covered under the EU Taxonomy or the positive contribution is not substantial enough to comply with the Taxonomy technical screening criteria, the investment can still be considered an environmentally Sustainable Investment provided it complies with all criteria. The Investment Manager does not commit to a minimum share of environmentally Sustainable Investments that are not aligned with the EU Taxonomy. The overall sustainable investment share may also include investments with an environmental objective in economic activities that do not qualify as environmentally sustainable under the EU Taxonomy, and while the Sub-Fund cannot commit to a minimum share of environmentally or socially sustainable investments, such investments may be freely allocated to within the Sub-Fund aggregated sustainable investment commitment disclosed (min. 2%).



are sustainable investments with an environmental objective that **do not take into account the criteria** for environmentally sustainable economic activities under the EU Taxonomy.



What is the minimum share of socially sustainable investments?

The Investment Manager defines Sustainable Investments based on internal research, which uses, among others, the UN Sustainable Development Goals (SDGs), as well as the objectives of the EU Taxonomy as reference frameworks. The Investment Manager does not commit to a minimum share of socially Sustainable Investments, as the SDGs contain environmental as well as social objectives. The overall sustainable investment share may also include investments with a social objective, and while the Sub-Fund cannot commit to a minimum share of environmentally or socially sustainable investments, such investments may be freely allocated to within the Sub-Fund aggregated sustainable investment commitment disclosed (min. 2%).



What investments are included under “#2 Other”, what is their purpose and are there any minimum environmental or social safeguards?

Under “#2 Other” investments into cash, Target Funds, or derivatives can be included. Derivatives might be used for efficient portfolio management (including risk hedging) and/or investment purposes, and Target Funds to benefit from a specific strategy. For those investments no environmental or social safeguards are applied.



Is a specific index designated as a reference benchmark to determine whether this financial product is aligned with the environmental and/or social characteristics that it promotes?

No reference benchmark has been designated for the purpose of attaining the environmental and/or social characteristics promoted by the Sub-Fund.

Reference benchmarks are indexes to measure whether the financial product attains the environmental or social characteristics that they promote.

- **How is the reference benchmark continuously aligned with each of the environmental or social characteristics promoted by the financial product?**
Not applicable
- **How is the alignment of the investment strategy with the methodology of the index ensured on a continuous basis?**
Not applicable
- **How does the designated index differ from a relevant broad market index?**
Not applicable
- **Where can the methodology used for the calculation of the designated index be found?**
Not applicable



Where can I find more product specific information online?

More product-specific information can be found on the website: <https://regulatory.allianzgi.com/SFDR>

Template pre-contractual disclosure for the financial products referred to in Article 8, paragraphs 1, 2 and 2a, of Regulation (EU) 2019/2088 and Article 6, first paragraph, of Regulation (EU) 2020/852

Product name:

Allianz Advanced Fixed Income Global

Legal entity identifier: 549300GEEY2YMMHYW726

Environmental and/or social characteristics

Sustainable investment means an investment in an economic activity that contributes to an environmental or social objective, provided that the investment does not significantly harm any environmental or social objective and that the investee companies follow good governance practices.

The **EU Taxonomy** is a classification system laid down in Regulation (EU) 2020/852, establishing a list of **environmentally sustainable economic activities**. That Regulation does not include a list of socially sustainable economic activities. Sustainable investments with an environmental objective might be aligned with the Taxonomy or not.

Does this financial product have a sustainable investment objective?	
<input checked="" type="radio"/> <input checked="" type="radio"/> Yes	<input checked="" type="radio"/> <input type="radio"/> No
<input type="checkbox"/> It will make a minimum of sustainable investments with an environmental objective: ___% <ul style="list-style-type: none"> <input type="checkbox"/> in economic activities that qualify as environmentally sustainable under the EU Taxonomy <input type="checkbox"/> in economic activities that do not qualify as environmentally sustainable under the EU Taxonomy 	<input checked="" type="checkbox"/> It promotes Environmental/Social (E/S) characteristics and while it does not have as its objective a sustainable investment, it will have a minimum proportion of 2.00% of sustainable investments <ul style="list-style-type: none"> <input checked="" type="checkbox"/> with an environmental objective in economic activities that qualify as environmentally sustainable under the EU Taxonomy <input checked="" type="checkbox"/> with an environmental objective in economic activities that do not qualify as environmentally sustainable under the EU Taxonomy <input checked="" type="checkbox"/> with a social objective
<input type="checkbox"/> It will make a minimum of sustainable investments with a social objective ___%	<input type="checkbox"/> It promotes E/S characteristics, but will not make any sustainable investments



What environmental and/or social characteristics are promoted by this financial product?

Allianz Advanced Fixed Income Global (the "Sub-Fund") promotes environmental, social, human rights, governance, and business behaviour factors (this domain does not apply for sovereigns issued by a Sovereign Entity) through integration of a best-in-class approach into the Sub-Fund's investment process. This encompasses the evaluation of corporate or sovereign issuers based on an SRI Rating which is used to construct the portfolio.

In addition, sustainable minimum exclusion criteria apply.

No reference benchmark has been designated for the purpose of attaining the environmental and/or social characteristics promoted by the Sub-Fund.

● What sustainability indicators are used to measure the attainment of each of the environmental or social characteristics promoted by this financial product?

To measure the attainment of the environmental and/or social characteristics the following sustainability indicators are used and reported on, at the fiscal year end:

- The actual percentage of the Sub-Fund's Portfolio (Portfolio in this respect does not comprise non-rated derivatives and instruments that are non-rated by nature (e. g., cash and deposits)) assets invested in best-in-class issuers (issuers with a minimum SRI Rating of 1 out of a scale from 0-4; 0 being the worst rating and 4 the best rating) is compared to the actual percentage of the benchmarks best-in-class issuers.
- Confirmation that Principal Adverse Impacts (PAIs) of investment decisions on sustainability factors are considered through the application of exclusion criteria.

Sustainability indicators measure how the environmental or social characteristics promoted by the financial product are attained.

- **What are the objectives of the sustainable investments that the financial product partially intends to make and how does the sustainable investment contribute to such objectives?**

Sustainable investments contribute to environmental and/or social objectives, for which the Investment Manager uses as reference frameworks, among others, the UN Sustainable Development Goals (SDGs), as well as the objectives of the EU Taxonomy:

1. Climate Change Mitigation
2. Climate Change Adaptation
3. Sustainable Use and Protection of Water and Marine Resources
4. Transition to a Circular Economy
5. Pollution Prevention and Control
6. Protection and Restoration of Biodiversity and Ecosystems

The assessment of the positive contribution to the environmental or social objectives is based on a proprietary framework which combines quantitative elements with qualitative inputs from internal research. The methodology applies first a quantitative breakdown of a securities issuer into its business activities. The qualitative element of the framework is an assessment if business activities contribute positively to an environmental or a social objective.

To calculate the positive contribution on the Sub-Fund level the revenue share of each issuer attributable to business activities contributing to environmental and/or social objectives is considered provided the issuer is satisfying the Do No Significant Harm ("DNSH") and Good Governance principles, and an asset-weighted aggregation is performed as a second step. Moreover, for certain types of securities, which finance specific projects contributing to environmental or social objectives the overall investment is considered to contribute to environmental and/or social objectives, but also for these a DNSH as well as a Good Governance check for issuers is performed.

- **How do the sustainable investments that the financial product partially intends to make, not cause significant harm to any environmental or social sustainable investment objective?**

In order to ensure that Sustainable Investments do not significantly harm any other environmental and/or social objective, the Investment Manager is leveraging the PAI indicators, whereby significance thresholds have been defined to identify significantly harmful issuers. Issuers not meeting the significance threshold can be engaged for a limited time period to remediate the adverse impact. Otherwise, if the issuer does not meet the defined significance thresholds twice subsequently or in case of a failed engagement, it does not pass the DNSH assessment. Investments in securities of issuers which do not pass the DNSH assessment are not counted as sustainable investments.

- *How have the indicators for adverse impacts on sustainability factors been taken into account?*

All mandatory PAI indicators are considered either as part of the application of the exclusion criteria or through thresholds on a sectorial or absolute basis. Significance thresholds have been defined and they refer to qualitative or quantitative criteria.

Recognizing the lack of data coverage for some of the PAI indicators equivalent data points are used to assess PAI indicators when applying the DNSH assessment, when relevant, for the following indicators for corporates: share of non-renewable energy consumption and production, activities negatively affecting biodiversity-sensitive areas, emissions to water, lack of processes and compliance mechanisms to monitor compliance with UNGC principles and OECD Guidelines for Multinational Enterprises; for sovereigns: GHG Intensity and investee countries subject to social violations. In case of securities which finance specific projects contributing to environmental or social objectives equivalent data at project level might be used to ensure that Sustainable Investments do not significantly harm any other environmental and/or social objective. The Investment Manager will strive to increase data coverage for PAI indicators with low data coverage by engaging with issuers and data providers. The Investment Manager will regularly evaluate whether the availability of data has increased sufficiently to potentially include assessment of such data in the investment process.

- *How are the sustainable investments aligned with the OECD Guidelines for Multinational Enterprises and the UN Guiding Principles on Business and Human Rights? Details:*

The Investment Manager's sustainable minimum exclusion list screens out companies based on their involvement in controversial practices against international norms. The core normative framework consists of the Principles of the UN Global Compact, the OECD Guidelines for Multinational Enterprises

Principal adverse impacts are the most significant negative impacts of investment decisions on sustainability factors relating to environmental, social and employee matters, respect for human rights, anti-corruption and anti-bribery matters.

and the UN Guiding Principles for Business and Human Rights. Securities issued by companies having a severe violation of these frameworks will be restricted from the investment universe.

The EU Taxonomy sets out a “do not significant harm” principle by which Taxonomy-aligned investments should not significantly harm EU Taxonomy objectives and is accompanied by specific EU criteria.

The “do not significant harm” principle applies only to those investments underlying the financial product that take into account the EU criteria for environmentally sustainable economic activities. The investments underlying the remaining portion of this financial product do not take into account the EU criteria for environmentally sustainable economic activities.

Any other sustainable investments must also not significantly harm any environmental or social objectives.



Does this financial product consider principal adverse impacts on sustainability factors?

Yes

No

The Management Company has joined the Net Zero Asset Manager Initiative and considers PAI indicators through stewardship including engagement, both are relevant to mitigate potential adverse impact as a company.

Due to the commitment to the Net Zero Asset Manager Initiative, the Management Company aims to reduce greenhouse gas emissions in partnership with asset owner clients on decarbonisation goals, consistent with an ambition to reach net zero emission by 2050 or sooner across all assets under management. As part of this objective the Management Company will set an interim target for the proportion of assets to be managed in line with the attainment of net zero emissions by 2050 or sooner.

The Sub-Fund’s Investment Manager considers PAI indicators regarding greenhouse gas emission, biodiversity, water, waste as well as social and employee matters for corporate issuers, and, where relevant, the freedom house index is applied to investments in sovereigns. PAI indicators are considered within the Investment Manager’s investment process through the means of exclusions as described in the “binding elements” section of the Sub-Fund.

The data coverage for the data required for the PAI indicators is heterogenous. The data coverage related to biodiversity, water and waste is low and the related PAI indicators are considered through exclusion of securities issued by companies having a severe violation / breach of principles and guidelines such as the Principles of the United Nations Global Compact, the OECD Guidelines for Multinational Enterprises, and the United Nations Guiding Principles for Business and Human Rights on the grounds of problematic practices around human rights, labour rights, environment, and corruption issues. Therefore, the Investment Manager will strive to increase data coverage for PAI indicators with low data coverage. The Investment Manager will regularly evaluate whether the availability of data has increased sufficiently to potentially include assessment of such data in the investment process.

Additionally, PAI indicators are, among other sustainability factors, applied to derive the SRI Rating. The SRI Rating is used for the portfolio construction.

The following PAI indicators are considered:

Applicable to corporate issuers

- GHG Emissions
- Carbon footprint
- GHG Intensity of investee companies
- Exposure to companies active in the fossil fuel sector
- Activities negatively affecting biodiversity-sensitive areas
- Emissions to water
- Hazardous waste ratio
- Violation of UN Global compact principles
- Lack of processes and compliance mechanisms to monitor compliance with UN Global Compact principles
- Board gender diversity
- Exposure to controversial weapons

Applicable to sovereign and supranational issuers

- Investee countries subject to social violations

The information on the PAI indicators will be available in the end-year report of the Sub-Fund.



The investment strategy guides investment decisions based on factors such as investment objectives and risk tolerance.

What investment strategy does this financial product follow?

Allianz Advanced Fixed Income Global's investment strategy is to invest in the global sovereign bond markets in accordance with the Sustainable and Responsible Investment Strategy (SRI Strategy).

As part of the SRI best-in-class approach, the Sub-Fund takes environmental, social, human rights, governance, and business behaviour factors into account as follows:

- The aforesaid sustainability factors are analysed through SRI Research by the Investment Manager in order to assess how sustainable development and long-term issues are taken into account in the strategy of an issuer. SRI Research means the overall process of identifying potential risks as well as potential opportunities of an investment in securities of an issuer related to the analysis of sustainability factors. SRI Research data combines external research data (which might have some limitations) with internal analyses.
- Based on a combination of the results of the external and/or internal analyses of the sustainability factors, an internal rating is derived monthly (SRI Rating) and is afterwards assigned to a corporate or sovereign issuer.

This internal SRI Rating is used to rank and select or weight securities for the portfolio construction.

The Sub-Fund's general investment approach (Sub-Fund's applicable General Asset Class Principles in combination with its individual investment restrictions) is described in the prospectus.

● What are the binding elements of the investment strategy used to select the investments to attain each of the environmental or social characteristics promoted by this financial product?

The binding elements are:

- Minimum rating coverage: At least 90% of the Sub-Fund's portfolio is required to have an SRI Rating (portfolio in this respect does not comprise non-rated derivatives and instruments that are non-rated by nature e.g., cash and deposits). While most holdings of the Sub-Fund will have a corresponding SRI Rating some investments cannot be rated according to the SRI Research methodology. Examples of instruments not attaining to the SRI Rating include, but are not limited to cash, deposits, Target Funds, and non-rated investments.
- The rated instruments are adhering to the minimum rating threshold of 1 (out of a rating scale from 0 – 4; 0 being the worst rating and 4 the best rating).
- Application of the following sustainable minimum exclusion criteria for direct investments:
 - securities issued by companies having a severe violation / breach of principles and guidelines such as the Principles of the United Nations Global Compact, the OECD Guidelines for Multinational Enterprises, and the United Nations Guiding Principles for Business and Human Rights on the grounds of problematic practices around human rights, labour rights, environment, and corruption issues,
 - securities issued by companies involved in controversial weapons (anti-personnel mines, cluster munitions, chemical weapons, biological weapons, depleted uranium, white phosphorus, and nuclear weapons),
 - securities issued by companies that derive more than 10% of their revenues from weapons, military equipment, and services,
 - securities issued by companies that derive more than 10% of their revenue from thermal coal extraction,
 - securities issued by utility companies that generate more than 20% of their revenues from coal,
 - securities issued by companies involved in the production of tobacco, and securities issued by companies involved in the distribution of tobacco with more than 5% of their revenues.

Direct investments in sovereign issuers with an insufficient freedom house index score are excluded.

The sustainable minimum exclusion criteria are based on information from an external data provider and coded in pre- and post-trade compliance. The review is performed at least half yearly.

- **What is the committed minimum rate to reduce the scope of the investments considered prior to the application of that investment strategy?**

The Sub-Fund does not commit to reduce the scope of the investments by a certain minimum rate.

- **What is the policy to assess good governance practices of the investee companies?**

Good governance principles are considered by screening out companies based on their involvement in controversies around international norms corresponding to the four good governance practices: sound management structures, employee relations, remuneration of staff and tax compliance. Companies having a severe violation in either of those areas will not be investible. For certain cases, flagged issuers shall be on a watch list. These companies will appear on this watch list when the Investment Manager believes that engagement may lead to improvements or when the company is assessed to take remedial actions. Companies on the watch list remain investible unless the Investment Manager believes that the engagement or the remedial actions of the company does not lead to the desired remedy of the severe controversy.

In addition, the Sub-Fund’s Investment Manager is committed to actively encourage open dialogues with investee companies on corporate governance, proxy voting and broader sustainability issues in advance of shareholder meetings (regularly for direct investments in shares). The Sub-Fund’s Investment Manager’s approach to proxy voting and company engagement is set out in the Management Company’s Stewardship Statement.

Good governance practices include sound management structures, employee relations, remuneration of staff and tax compliance.



What is the asset allocation planned for this financial product?

Asset allocation describes the share of investments in specific assets.

Min. 90% of the Sub-Funds’ assets (excluding cash and non-rated derivatives) are used to meet the environmental or social characteristics promoted by this Sub-Fund. A low portion of the Sub-Fund might contain assets which do not promote environmental or social characteristics. Examples of such instruments are derivatives, cash and deposits, some Target Funds and investment with temporarily divergent or absent environmental, social, or good governance qualifications. Min. 2% of the Sub-Funds' assets will be invested in Sustainable Investments. The minimum percentage of investments that are aligned with the EU Taxonomy is 0.01%. The Sub-Fund’s Investment Manager does not commit to a minimum share of environmentally Sustainable Investments that are not aligned with the EU Taxonomy. The Sub-Fund’s Investment Manager does not commit to a minimum share of socially sustainable investments. While the Sub-Fund cannot commit to a minimum share of environmentally or socially sustainable investments, such investments may be freely allocated to within the Sub-Fund aggregated sustainable investment commitment disclosed (min. 2%).

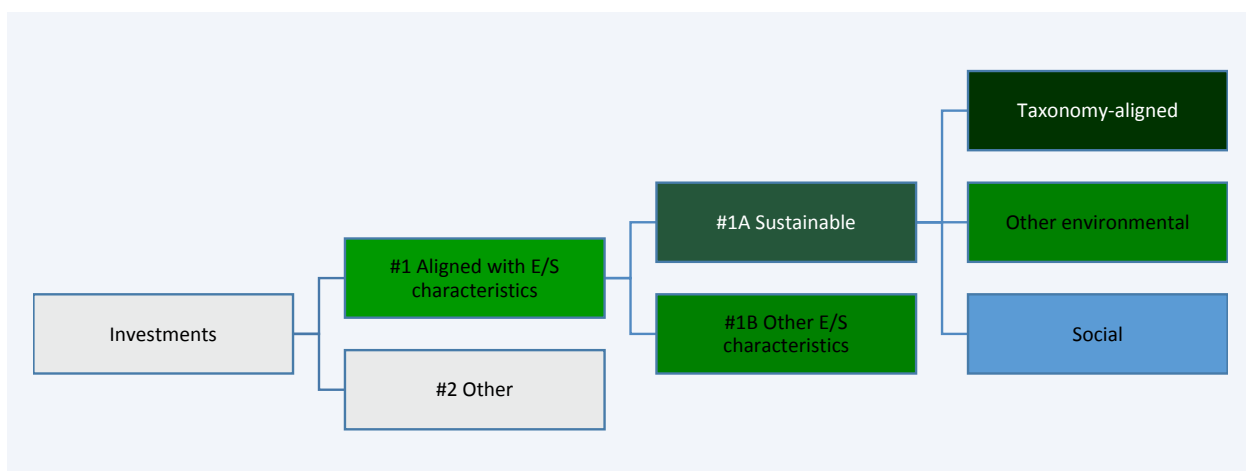

#1 Aligned with E/S characteristics includes the investments of the financial product used to attain the environmental or social characteristics promoted by the financial product.

#2 Other includes the remaining investments of the financial product which are neither aligned with the environmental or social characteristics, nor are qualified as sustainable investments.

The category **#1 Aligned with E/S characteristics** covers:

- The sub-category **#1A Sustainable** covers sustainable investments with environmental or social objectives.
- The sub-category **#1B Other E/S characteristics** covers investments aligned with the environmental or social characteristics that do not qualify as sustainable investments.

- How does the use of derivatives attain the environmental or social characteristics promoted by the financial product?

Not applicable



To what minimum extent are sustainable investments with an environmental objective aligned with the EU Taxonomy?

The Taxonomy-aligned investments include debt and/or equity in environmentally sustainable economic activities aligned with the EU-Taxonomy. The minimum percentage of investments that are aligned with the EU Taxonomy is 0.01%. Taxonomy-aligned data is provided by an external data provider. The Investment Manager has assessed the quality of such data. The data will not be subject to an assurance provided by auditors or a review by third parties. The data will not reflect any data in government bonds. As of today, there is no recognized methodology available to determine the proportion of Taxonomy-aligned activities when investing in government bonds.

Taxonomy-aligned activities in this disclosure are based on share of turnover. Pre-contractual figures use turnover as its financial metric as a default in line with the regulatory requirements and based on the fact that complete, verifiable or up-to date data for CAPEX and/or OPEX as financial metric is even less available.

Taxonomy-aligned data is only in rare cases data reported by companies in accordance with the EU Taxonomy. The data provider has derived Taxonomy-aligned data from other available equivalent public data.

- Does the financial product invest in fossil gas and/or nuclear energy related activities that comply with the EU Taxonomy ¹?

Yes:

In fossil gas In nuclear energy

No

The Sub-Fund does not pursue any investments in fossil gas and/or nuclear energy related activities that comply with the EU Taxonomy. Nevertheless, as result of this investment strategy, investments may occur in corporates which are also active in these activities. Further information will be provided as part of the annual reporting, if relevant.

The two graphs below show in green the minimum percentage of investments that are aligned with the EU Taxonomy. As there is no appropriate methodology to determine the Taxonomy-alignment of sovereign bonds*, the first graph shows the Taxonomy-alignment in relation to all the investments of the financial product including sovereign bonds, while the second graph shows the Taxonomy-alignment only in relation to the investments of the financial product other than sovereign bonds.

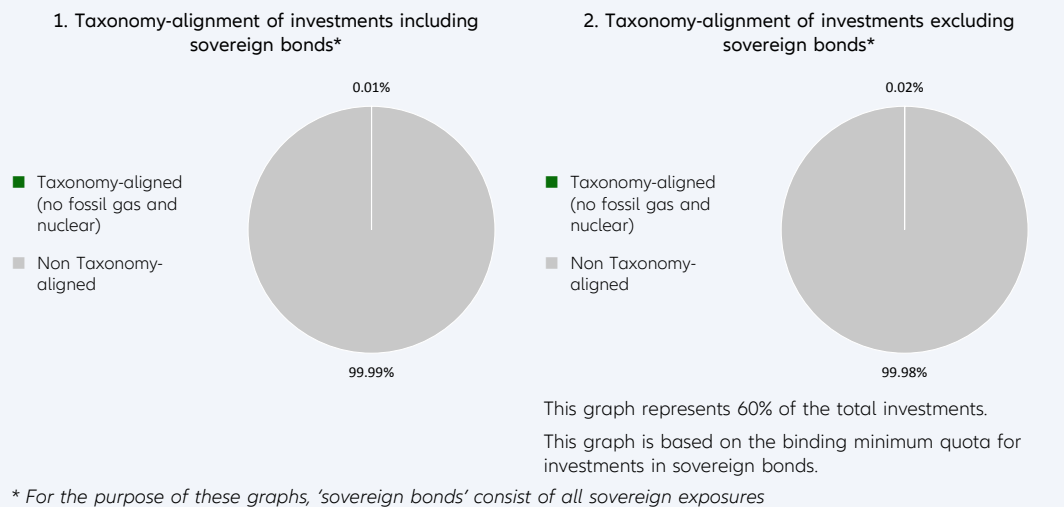

Taxonomy-aligned activities are expressed as a share of:

- **turnover** reflecting the share of revenue from green activities of investee companies
- **capital expenditure (CapEx)** showing the green investments made by investee companies, e.g. for a transition to a green economy.
- **operational expenditure (OpEx)** reflecting green operational activities of investee companies.

¹ Fossil gas and/or nuclear related activities will only comply with the EU Taxonomy where they contribute to limiting climate change ("climate change mitigation") and do not significantly harm any EU Taxonomy objective - see explanatory note in the left hand margin. The full criteria for fossil gas and nuclear energy economic activities that comply with the EU Taxonomy are laid down in Commission Delegated Regulation (EU) 2022/1214.

Enabling activities directly enable other activities to make a substantial contribution to an environmental objective.

Transitional activities are activities for which low-carbon alternatives are not yet available and among others have greenhouse gas emission levels corresponding to the best performance.

- **What is the minimum share of investments in transitional and enabling activities?**
The Sub-Fund’s Investment Manager does not commit to a split of minimum taxonomy alignment into transitional, enabling activities and own performance.



What is the minimum share of sustainable investments with an environmental objective that are not aligned with the EU Taxonomy?

Taxonomy-aligned investments are considered a sub-category of Sustainable Investments. If an investment is not Taxonomy-aligned since the activity is not yet covered under the EU Taxonomy or the positive contribution is not substantial enough to comply with the Taxonomy technical screening criteria, the investment can still be considered an environmentally Sustainable Investment provided it complies with all criteria. The Investment Manager does not commit to a minimum share of environmentally Sustainable Investments that are not aligned with the EU Taxonomy. The overall sustainable investment share may also include investments with an environmental objective in economic activities that do not qualify as environmentally sustainable under the EU Taxonomy, and while the Sub-Fund cannot commit to a minimum share of environmentally or socially sustainable investments, such investments may be freely allocated to within the Sub-Fund aggregated sustainable investment commitment disclosed (min. 2%).



are sustainable investments with an environmental objective that **do not take into account the criteria** for environmentally sustainable economic activities under the EU Taxonomy.



What is the minimum share of socially sustainable investments?

The Investment Manager defines Sustainable Investments based on internal research, which uses, among others, the UN Sustainable Development Goals (SDGs), as well as the objectives of the EU Taxonomy as reference frameworks. The Investment Manager does not commit to a minimum share of socially Sustainable Investments, as the SDGs contain environmental as well as social objectives. The overall sustainable investment share may also include investments with a social objective, and while the Sub-Fund cannot commit to a minimum share of environmentally or socially sustainable investments, such investments may be freely allocated to within the Sub-Fund aggregated sustainable investment commitment disclosed (min. 2%).



What investments are included under “#2 Other”, what is their purpose and are there any minimum environmental or social safeguards?

Under “#2 Other” investments into cash, Target Funds, or derivatives can be included. Derivatives might be used for efficient portfolio management (including risk hedging) and/or investment purposes, and Target Funds to benefit from a specific strategy. For those investments no environmental or social safeguards are applied.



Is a specific index designated as a reference benchmark to determine whether this financial product is aligned with the environmental and/or social characteristics that it promotes?

No reference benchmark has been designated for the purpose of attaining the environmental and/or social characteristics promoted by the Sub-Fund.

Reference benchmarks are indexes to measure whether the financial product attains the environmental or social characteristics that they promote.

- **How is the reference benchmark continuously aligned with each of the environmental or social characteristics promoted by the financial product?**
Not applicable
- **How is the alignment of the investment strategy with the methodology of the index ensured on a continuous basis?**
Not applicable
- **How does the designated index differ from a relevant broad market index?**
Not applicable
- **Where can the methodology used for the calculation of the designated index be found?**
Not applicable



Where can I find more product specific information online?

More product-specific information can be found on the website: <https://regulatory.allianzgi.com/SFDR>

Template pre-contractual disclosure for the financial products referred to in Article 8, paragraphs 1, 2 and 2a, of Regulation (EU) 2019/2088 and Article 6, first paragraph, of Regulation (EU) 2020/852

Product name:

Allianz Advanced Fixed Income Global Aggregate

Legal entity identifier: 549300XB0VU2T4JU6365

Environmental and/or social characteristics

Sustainable investment means an investment in an economic activity that contributes to an environmental or social objective, provided that the investment does not significantly harm any environmental or social objective and that the investee companies follow good governance practices.

The **EU Taxonomy** is a classification system laid down in Regulation (EU) 2020/852, establishing a list of **environmentally sustainable economic activities**. That Regulation does not include a list of socially sustainable economic activities. Sustainable investments with an environmental objective might be aligned with the Taxonomy or not.

Does this financial product have a sustainable investment objective?	
<input checked="" type="radio"/> <input checked="" type="radio"/> Yes	<input checked="" type="radio"/> <input type="radio"/> No
<input type="checkbox"/> It will make a minimum of sustainable investments with an environmental objective: ___% <ul style="list-style-type: none"> <input type="checkbox"/> in economic activities that qualify as environmentally sustainable under the EU Taxonomy <input type="checkbox"/> in economic activities that do not qualify as environmentally sustainable under the EU Taxonomy 	<input checked="" type="checkbox"/> It promotes Environmental/Social (E/S) characteristics and while it does not have as its objective a sustainable investment, it will have a minimum proportion of 2.00% of sustainable investments <ul style="list-style-type: none"> <input checked="" type="checkbox"/> with an environmental objective in economic activities that qualify as environmentally sustainable under the EU Taxonomy <input checked="" type="checkbox"/> with an environmental objective in economic activities that do not qualify as environmentally sustainable under the EU Taxonomy <input checked="" type="checkbox"/> with a social objective
<input type="checkbox"/> It will make a minimum of sustainable investments with a social objective ___%	<input type="checkbox"/> It promotes E/S characteristics, but will not make any sustainable investments



What environmental and/or social characteristics are promoted by this financial product?

Allianz Advanced Fixed Income Global Aggregate (the "Sub-Fund") promotes environmental, social, human rights, governance, and business behaviour factors (this domain does not apply for sovereigns issued by a Sovereign Entity) through integration of a best-in-class approach into the Sub-Fund's investment process. This encompasses the evaluation of corporate or sovereign issuers based on an SRI Rating which is used to construct the portfolio.

In addition, sustainable minimum exclusion criteria apply.

No reference benchmark has been designated for the purpose of attaining the environmental and/or social characteristics promoted by the Sub-Fund.

What sustainability indicators are used to measure the attainment of each of the environmental or social characteristics promoted by this financial product?

To measure the attainment of the environmental and/or social characteristics the following sustainability indicators are used and reported on, at the fiscal year end:

- The actual percentage of the Sub-Fund's Portfolio (Portfolio in this respect does not comprise non-rated derivatives and instruments that are non-rated by nature (e. g., cash and deposits)) assets invested in best-in-class issuers (issuers with a minimum SRI Rating of 1 out of a scale from 0-4; 0 being the worst rating and 4 the best rating) is compared to the actual percentage of the benchmarks best-in-class issuers.

Sustainability indicators measure how the environmental or social characteristics promoted by the financial product are attained.

- Confirmation that Principal Adverse Impacts (PAIs) of investment decisions on sustainability factors are considered through the application of exclusion criteria.

- **What are the objectives of the sustainable investments that the financial product partially intends to make and how does the sustainable investment contribute to such objectives?**

Sustainable investments contribute to environmental and/or social objectives, for which the Investment Manager uses as reference frameworks, among others, the UN Sustainable Development Goals (SDGs), as well as the objectives of the EU Taxonomy:

1. Climate Change Mitigation
2. Climate Change Adaptation
3. Sustainable Use and Protection of Water and Marine Resources
4. Transition to a Circular Economy
5. Pollution Prevention and Control
6. Protection and Restoration of Biodiversity and Ecosystems

The assessment of the positive contribution to the environmental or social objectives is based on a proprietary framework which combines quantitative elements with qualitative inputs from internal research. The methodology applies first a quantitative breakdown of a securities issuer into its business activities. The qualitative element of the framework is an assessment if business activities contribute positively to an environmental or a social objective.

To calculate the positive contribution on the Sub-Fund level the revenue share of each issuer attributable to business activities contributing to environmental and/or social objectives is considered provided the issuer is satisfying the Do No Significant Harm (“DNSH”) and Good Governance principles, and an asset-weighted aggregation is performed as a second step. Moreover, for certain types of securities, which finance specific projects contributing to environmental or social objectives the overall investment is considered to contribute to environmental and/or social objectives, but also for these a DNSH as well as a Good Governance check for issuers is performed.

- **How do the sustainable investments that the financial product partially intends to make, not cause significant harm to any environmental or social sustainable investment objective?**

In order to ensure that Sustainable Investments do not significantly harm any other environmental and/or social objective, the Investment Manager is leveraging the PAI indicators, whereby significance thresholds have been defined to identify significantly harmful issuers. Issuers not meeting the significance threshold can be engaged for a limited time period to remediate the adverse impact. Otherwise, if the issuer does not meet the defined significance thresholds twice subsequently or in case of a failed engagement, it does not pass the DNSH assessment. Investments in securities of issuers which do not pass the DNSH assessment are not counted as sustainable investments.

- *How have the indicators for adverse impacts on sustainability factors been taken into account?*

All mandatory PAI indicators are considered either as part of the application of the exclusion criteria or through thresholds on a sectorial or absolute basis. Significance thresholds have been defined and they refer to qualitative or quantitative criteria.

Recognizing the lack of data coverage for some of the PAI indicators equivalent data points are used to assess PAI indicators when applying the DNSH assessment, when relevant, for the following indicators for corporates: share of non-renewable energy consumption and production, activities negatively affecting biodiversity-sensitive areas, emissions to water, lack of processes and compliance mechanisms to monitor compliance with UNGC principles and OECD Guidelines for Multinational Enterprises; for sovereigns: GHG Intensity and investee countries subject to social violations. In case of securities which finance specific projects contributing to environmental or social objectives equivalent data at project level might be used to ensure that Sustainable Investments do not significantly harm any other environmental and/or social objective. The Investment Manager will strive to increase data coverage for PAI indicators with low data coverage by engaging with issuers and data providers. The Investment Manager will regularly evaluate whether the availability of data has increased sufficiently to potentially include assessment of such data in the investment process.

Principal adverse impacts are the most significant negative impacts of investment decisions on sustainability factors relating to environmental, social and employee matters, respect for human rights, anti-corruption and anti-bribery matters.

- *How are the sustainable investments aligned with the OECD Guidelines for Multinational Enterprises and the UN Guiding Principles on Business and Human Rights? Details:*

The Investment Manager's sustainable minimum exclusion list screens out companies based on their involvement in controversial practices against international norms. The core normative framework consists of the Principles of the UN Global Compact, the OECD Guidelines for Multinational Enterprises and the UN Guiding Principles for Business and Human Rights. Securities issued by companies having a severe violation of these frameworks will be restricted from the investment universe.

The EU Taxonomy sets out a "do not significant harm" principle by which Taxonomy-aligned investments should not significantly harm EU Taxonomy objectives and is accompanied by specific EU criteria.

The "do not significant harm" principle applies only to those investments underlying the financial product that take into account the EU criteria for environmentally sustainable economic activities. The investments underlying the remaining portion of this financial product do not take into account the EU criteria for environmentally sustainable economic activities.

Any other sustainable investments must also not significantly harm any environmental or social objectives.



Does this financial product consider principal adverse impacts on sustainability factors?

Yes

No

The Management Company has joined the Net Zero Asset Manager Initiative and considers PAI indicators through stewardship including engagement, both are relevant to mitigate potential adverse impact as a company.

Due to the commitment to the Net Zero Asset Manager Initiative, the Management Company aims to reduce greenhouse gas emissions in partnership with asset owner clients on decarbonisation goals, consistent with an ambition to reach net zero emission by 2050 or sooner across all assets under management. As part of this objective the Management Company will set an interim target for the proportion of assets to be managed in line with the attainment of net zero emissions by 2050 or sooner.

The Sub-Fund's Investment Manager considers PAI indicators regarding greenhouse gas emission, biodiversity, water, waste as well as social and employee matters for corporate issuers, and, where relevant, the freedom house index is applied to investments in sovereigns. PAI indicators are considered within the Investment Manager's investment process through the means of exclusions as described in the "binding elements" section of the Sub-Fund.

The data coverage for the data required for the PAI indicators is heterogenous. The data coverage related to biodiversity, water and waste is low and the related PAI indicators are considered through exclusion of securities issued by companies having a severe violation / breach of principles and guidelines such as the Principles of the United Nations Global Compact, the OECD Guidelines for Multinational Enterprises, and the United Nations Guiding Principles for Business and Human Rights on the grounds of problematic practices around human rights, labour rights, environment, and corruption issues. Therefore, the Investment Manager will strive to increase data coverage for PAI indicators with low data coverage. The Investment Manager will regularly evaluate whether the availability of data has increased sufficiently to potentially include assessment of such data in the investment process.

Additionally, PAI indicators are, among other sustainability factors, applied to derive the SRI Rating. The SRI Rating is used for the portfolio construction.

The following PAI indicators are considered:

Applicable to corporate issuers

- GHG Emissions
- Carbon footprint
- GHG Intensity of investee companies
- Exposure to companies active in the fossil fuel sector
- Activities negatively affecting biodiversity-sensitive areas
- Emissions to water
- Hazardous waste ratio

- Violation of UN Global compact principles
- Lack of processes and compliance mechanisms to monitor compliance with UN Global Compact principles
- Board gender diversity
- Exposure to controversial weapons

Applicable to sovereign and supranational issuers

- Investee countries subject to social violations

The information on the PAI indicators will be available in the end-year report of the Sub-Fund.



The investment strategy guides investment decisions based on factors such as investment objectives and risk tolerance.

What investment strategy does this financial product follow?

Allianz Advanced Fixed Income Global Aggregate's investment objective is to invest in global corporate and government Bond Markets in accordance with the Sustainable and Responsible Investment Strategy (SRI Strategy).

As part of the SRI best-in-class approach, the Sub-Fund takes environmental, social, human rights, governance, and business behaviour factors into account as follows:

- The aforesaid sustainability factors are analysed through SRI Research by the Investment Manager in order to assess how sustainable development and long-term issues are taken into account in the strategy of an issuer. SRI Research means the overall process of identifying potential risks as well as potential opportunities of an investment in securities of an issuer related to the analysis of sustainability factors. SRI Research data combines external research data (which might have some limitations) with internal analyses.
- Based on a combination of the results of the external and/or internal analyses of the sustainability factors, an internal rating is derived monthly (SRI Rating) and is afterwards assigned to a corporate or sovereign issuer.

This internal SRI Rating is used to rank and select or weight securities for the portfolio construction.

The Sub-Fund's general investment approach (Sub-Fund's applicable General Asset Class Principles in combination with its individual investment restrictions) is described in the prospectus.

● What are the binding elements of the investment strategy used to select the investments to attain each of the environmental or social characteristics promoted by this financial product?

The binding elements are:

- Minimum rating coverage: At least 90% of the Sub-Fund's portfolio is required to have an SRI Rating (portfolio in this respect does not comprise non-rated derivatives and instruments that are non-rated by nature e.g., cash and deposits). While most holdings of the Sub-Fund will have a corresponding SRI Rating some investments cannot be rated according to the SRI Research methodology. Examples of instruments not attaining to the SRI Rating include, but are not limited to cash, deposits, Target Funds, and non-rated investments.
- The rated instruments are adhering to the minimum rating threshold of 1 (out of a rating scale from 0 – 4; 0 being the worst rating and 4 the best rating).
- Application of the following sustainable minimum exclusion criteria for direct investments:
 - securities issued by companies having a severe violation / breach of principles and guidelines such as the Principles of the United Nations Global Compact, the OECD Guidelines for Multinational Enterprises, and the United Nations Guiding Principles for Business and Human Rights on the grounds of problematic practices around human rights, labour rights, environment, and corruption issues,
 - securities issued by companies involved in controversial weapons (anti-personnel mines, cluster munitions, chemical weapons, biological weapons, depleted uranium, white phosphorus, and nuclear weapons),
 - securities issued by companies that derive more than 10% of their revenues from weapons, military equipment, and services,
 - securities issued by companies that derive more than 10% of their revenue from thermal coal extraction,
 - securities issued by utility companies that generate more than 20% of their revenues from coal,

- securities issued by companies involved in the production of tobacco, and securities issued by companies involved in the distribution of tobacco with more than 5% of their revenues.

Direct investments in sovereign issuers with an insufficient freedom house index score are excluded.

The sustainable minimum exclusion criteria are based on information from an external data provider and coded in pre- and post-trade compliance. The review is performed at least half yearly.

- **What is the committed minimum rate to reduce the scope of the investments considered prior to the application of that investment strategy?**

The Sub-Fund does not commit to reduce the scope of the investments by a certain minimum rate.

- **What is the policy to assess good governance practices of the investee companies?**

Good governance principles are considered by screening out companies based on their involvement in controversies around international norms corresponding to the four good governance practices: sound management structures, employee relations, remuneration of staff and tax compliance. Companies having a severe violation in either of those areas will not be investible. For certain cases, flagged issuers shall be on a watch list. These companies will appear on this watch list when the Investment Manager believes that engagement may lead to improvements or when the company is assessed to take remedial actions. Companies on the watch list remain investible unless the Investment Manager believes that the engagement or the remedial actions of the company does not lead to the desired remedy of the severe controversy.

In addition, the Sub-Fund's Investment Manager is committed to actively encourage open dialogues with investee companies on corporate governance, proxy voting and broader sustainability issues in advance of shareholder meetings (regularly for direct investments in shares). The Sub-Fund's Investment Manager's approach to proxy voting and company engagement is set out in the Management Company's Stewardship Statement.

Good governance practices include sound management structures, employee relations, remuneration of staff and tax compliance.



What is the asset allocation planned for this financial product?

Asset allocation describes the share of investments in specific assets.

Min. 90% of the Sub-Funds' assets (excluding cash and non-rated derivatives) are used to meet the environmental or social characteristics promoted by this Sub-Fund. A low portion of the Sub-Fund might contain assets which do not promote environmental or social characteristics. Examples of such instruments are derivatives, cash and deposits, some Target Funds and investment with temporarily divergent or absent environmental, social, or good governance qualifications. Min. 2% of the Sub-Funds' assets will be invested in Sustainable Investments. The minimum percentage of investments that are aligned with the EU Taxonomy is 0.01%. The Sub-Fund's Investment Manager does not commit to a minimum share of environmentally Sustainable Investments that are not aligned with the EU Taxonomy. The Sub-Fund's Investment Manager does not commit to a minimum share of socially sustainable investments. While the Sub-Fund cannot commit to a minimum share of environmentally or socially sustainable investments, such investments may be freely allocated to within the Sub-Fund aggregated sustainable investment commitment disclosed (min. 2%).

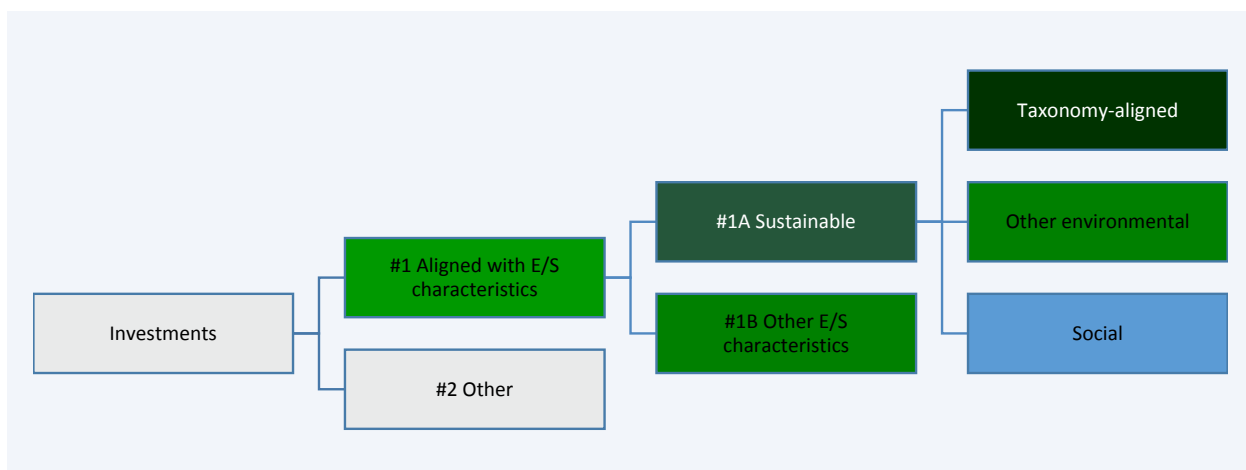

#1 Aligned with E/S characteristics includes the investments of the financial product used to attain the environmental or social characteristics promoted by the financial product.

#2 Other includes the remaining investments of the financial product which are neither aligned with the environmental or social characteristics, nor are qualified as sustainable investments.

The category **#1 Aligned with E/S characteristics** covers:

- The sub-category **#1A Sustainable** covers sustainable investments with environmental or social objectives.
- The sub-category **#1B Other E/S characteristics** covers investments aligned with the environmental or social characteristics that do not qualify as sustainable investments.

- **How does the use of derivatives attain the environmental or social characteristics promoted by the financial product?**

Not applicable



To what minimum extent are sustainable investments with an environmental objective aligned with the EU Taxonomy?

The Taxonomy-aligned investments include debt and/or equity in environmentally sustainable economic activities aligned with the EU-Taxonomy. The minimum percentage of investments that are aligned with the EU Taxonomy is 0.01%. Taxonomy-aligned data is provided by an external data provider. The Investment Manager has assessed the quality of such data. The data will not be subject to an assurance provided by auditors or a review by third parties. The data will not reflect any data in government bonds. As of today, there is no recognized methodology available to determine the proportion of Taxonomy-aligned activities when investing in government bonds.

Taxonomy-aligned activities in this disclosure are based on share of turnover. Pre-contractual figures use turnover as its financial metric as a default in line with the regulatory requirements and based on the fact that complete, verifiable or up-to date data for CAPEX and/or OPEX as financial metric is even less available.

Taxonomy-aligned data is only in rare cases data reported by companies in accordance with the EU Taxonomy. The data provider has derived Taxonomy-aligned data from other available equivalent public data.

- **Does the financial product invest in fossil gas and/or nuclear energy related activities that comply with the EU Taxonomy¹?**

Yes:

In fossil gas In nuclear energy

No

The Sub-Fund does not pursue any investments in fossil gas and/or nuclear energy related activities that comply with the EU Taxonomy. Nevertheless, as result of this investment strategy, investments may occur in corporates which are also active in these activities. Further information will be provided as part of the annual reporting, if relevant.

Taxonomy-aligned activities are expressed as a share of:

- **turnover** reflecting the share of revenue from green activities of investee companies
- **capital expenditure** (CapEx) showing the green investments made by investee companies, e.g. for a transition to a green economy.
- **operational expenditure** (OpEx) reflecting green operational activities of investee companies.

¹ Fossil gas and/or nuclear related activities will only comply with the EU Taxonomy where they contribute to limiting climate change ("climate change mitigation") and do not significantly harm any EU Taxonomy objective - see explanatory note in the left hand margin. The full criteria for fossil gas and nuclear energy economic activities that comply with the EU Taxonomy are laid down in Commission Delegated Regulation (EU) 2022/1214.

The two graphs below show in green the minimum percentage of investments that are aligned with the EU Taxonomy. As there is no appropriate methodology to determine the Taxonomy-alignment of sovereign bonds*, the first graph shows the Taxonomy-alignment in relation to all the investments of the financial product including sovereign bonds, while the second graph shows the Taxonomy-alignment only in relation to the investments of the financial product other than sovereign bonds.

1. Taxonomy-alignment of investments including sovereign bonds*

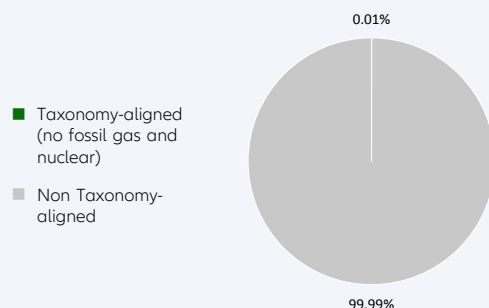

2. Taxonomy-alignment of investments excluding sovereign bonds*

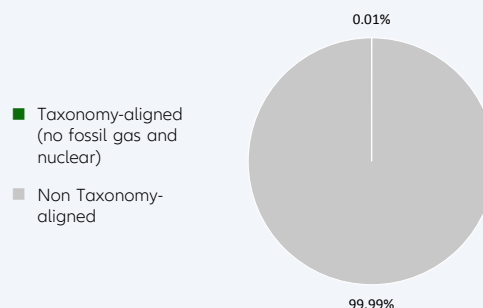

This graph represents X% of the total investments. It is noted that this Sub-Fund does not provide for a binding minimum quota for investments in sovereign bonds. Therefore, this Sub-Fund may have (but must not have) an exposure to sovereign bonds. In the absence of a binding minimum quota for investments in sovereign bonds, this graph does not generate any additional added value compared to the left-hand graph.

* For the purpose of these graphs, 'sovereign bonds' consist of all sovereign exposures

Enabling activities directly enable other activities to make a substantial contribution to an environmental objective.

Transitional activities are activities for which low-carbon alternatives are not yet available and among others have greenhouse gas emission levels corresponding to the best performance.

● **What is the minimum share of investments in transitional and enabling activities?**

The Sub-Fund's Investment Manager does not commit to a split of minimum taxonomy alignment into transitional, enabling activities and own performance.



What is the minimum share of sustainable investments with an environmental objective that are not aligned with the EU Taxonomy?

Taxonomy-aligned investments are considered a sub-category of Sustainable Investments. If an investment is not Taxonomy-aligned since the activity is not yet covered under the EU Taxonomy or the positive contribution is not substantial enough to comply with the Taxonomy technical screening criteria, the investment can still be considered an environmentally Sustainable Investment provided it complies with all criteria. The Investment Manager does not commit to a minimum share of environmentally Sustainable Investments that are not aligned with the EU Taxonomy. The overall sustainable investment share may also include investments with an environmental objective in economic activities that do not qualify as environmentally sustainable under the EU Taxonomy, and while the Sub-Fund cannot commit to a minimum share of environmentally or socially sustainable investments, such investments may be freely allocated to within the Sub-Fund aggregated sustainable investment commitment disclosed (min. 2%).



are sustainable investments with an environmental objective that **do not take into account the criteria** for environmentally sustainable economic activities under the EU Taxonomy.



What is the minimum share of socially sustainable investments?

The Investment Manager defines Sustainable Investments based on internal research, which uses, among others, the UN Sustainable Development Goals (SDGs), as well as the objectives of the EU Taxonomy as reference frameworks. The Investment Manager does not commit to a minimum share of socially Sustainable Investments, as the SDGs contain environmental as well as social objectives. The overall sustainable investment share may also include investments with a social objective, and while the Sub-Fund cannot commit to a minimum share of environmentally or socially sustainable investments, such investments may be freely allocated to within the Sub-Fund aggregated sustainable investment commitment disclosed (min. 2%).



What investments are included under “#2 Other”, what is their purpose and are there any minimum environmental or social safeguards?

Under “#2 Other” investments into cash, Target Funds, or derivatives can be included. Derivatives might be used for efficient portfolio management (including risk hedging) and/or investment purposes, and Target Funds to benefit from a specific strategy. For those investments no environmental or social safeguards are applied.



Is a specific index designated as a reference benchmark to determine whether this financial product is aligned with the environmental and/or social characteristics that it promotes?

No reference benchmark has been designated for the purpose of attaining the environmental and/or social characteristics promoted by the Sub-Fund.

- How is the reference benchmark continuously aligned with each of the environmental or social characteristics promoted by the financial product?

Not applicable

- How is the alignment of the investment strategy with the methodology of the index ensured on a continuous basis?

Not applicable

- How does the designated index differ from a relevant broad market index?

Not applicable

- Where can the methodology used for the calculation of the designated index be found?

Not applicable



Where can I find more product specific information online?

More product-specific information can be found on the website: <https://regulatory.allianzgi.com/SFDR>

Reference benchmarks are indexes to measure whether the financial product attains the environmental or social characteristics that they promote.

Template pre-contractual disclosure for the financial products referred to in Article 8, paragraphs 1, 2 and 2a, of Regulation (EU) 2019/2088 and Article 6, first paragraph, of Regulation (EU) 2020/852

Product name:

Allianz Advanced Fixed Income Short Duration

Legal entity identifier: 529900QKKROQJ7LYYV65

Environmental and/or social characteristics

Sustainable investment means an investment in an economic activity that contributes to an environmental or social objective, provided that the investment does not significantly harm any environmental or social objective and that the investee companies follow good governance practices.

The **EU Taxonomy** is a classification system laid down in Regulation (EU) 2020/852, establishing a list of **environmentally sustainable economic activities**. That Regulation does not include a list of socially sustainable economic activities. Sustainable investments with an environmental objective might be aligned with the Taxonomy or not.

Does this financial product have a sustainable investment objective?	
<input checked="" type="radio"/> <input checked="" type="radio"/> Yes	<input checked="" type="radio"/> <input type="radio"/> No
<input type="checkbox"/> It will make a minimum of sustainable investments with an environmental objective : ____% <input type="checkbox"/> in economic activities that qualify as environmentally sustainable under the EU Taxonomy <input type="checkbox"/> in economic activities that do not qualify as environmentally sustainable under the EU Taxonomy	<input checked="" type="checkbox"/> It promotes Environmental/Social (E/S) characteristics and while it does not have as its objective a sustainable investment, it will have a minimum proportion of 10.00% of sustainable investments <input checked="" type="checkbox"/> with an environmental objective in economic activities that qualify as environmentally sustainable under the EU Taxonomy <input checked="" type="checkbox"/> with an environmental objective in economic activities that do not qualify as environmentally sustainable under the EU Taxonomy <input checked="" type="checkbox"/> with a social objective
<input type="checkbox"/> It will make a minimum of sustainable investments with a social objective ____%	<input type="checkbox"/> It promotes E/S characteristics, but will not make any sustainable investments



What environmental and/or social characteristics are promoted by this financial product?

Allianz Advanced Fixed Income Short Duration (the "Sub-Fund") promotes environmental, social, human rights, governance, and business behaviour factors (this domain does not apply for sovereigns issued by a Sovereign Entity) through integration of a best-in-class approach into the Sub-Fund's investment process. This encompasses the evaluation of corporate or sovereign issuers based on an SRI Rating which is used to construct the portfolio.

In addition, sustainable minimum exclusion criteria apply.

No reference benchmark has been designated for the purpose of attaining the environmental and/or social characteristics promoted by the Sub-Fund.

What sustainability indicators are used to measure the attainment of each of the environmental or social characteristics promoted by this financial product?

To measure the attainment of the environmental and/or social characteristics the following sustainability indicators are used and reported on, at the fiscal year end:

- The actual percentage of the Sub-Fund's Portfolio (Portfolio in this respect does not comprise non-rated derivatives and instruments that are non-rated by nature (e. g., cash and deposits)) assets invested in best-in-class issuers (issuers with a minimum SRI Rating of 1 out of a scale from 0-4; 0 being the worst rating and 4 the best rating) is compared to the actual percentage of the benchmarks best-in-class issuers.
- Confirmation that Principal Adverse Impacts (PAIs) of investment decisions on sustainability factors are considered through the application of exclusion criteria.

Sustainability indicators measure how the environmental or social characteristics promoted by the financial product are attained.

- **What are the objectives of the sustainable investments that the financial product partially intends to make and how does the sustainable investment contribute to such objectives?**

Sustainable investments contribute to environmental and/or social objectives, for which the Investment Manager uses as reference frameworks, among others, the UN Sustainable Development Goals (SDGs), as well as the objectives of the EU Taxonomy:

1. Climate Change Mitigation
2. Climate Change Adaptation
3. Sustainable Use and Protection of Water and Marine Resources
4. Transition to a Circular Economy
5. Pollution Prevention and Control
6. Protection and Restoration of Biodiversity and Ecosystems

The assessment of the positive contribution to the environmental or social objectives is based on a proprietary framework which combines quantitative elements with qualitative inputs from internal research. The methodology applies first a quantitative breakdown of a securities issuer into its business activities. The qualitative element of the framework is an assessment if business activities contribute positively to an environmental or a social objective.

To calculate the positive contribution on the Sub-Fund level the revenue share of each issuer attributable to business activities contributing to environmental and/or social objectives is considered provided the issuer is satisfying the Do No Significant Harm ("DNSH") and Good Governance principles, and an asset-weighted aggregation is performed as a second step. Moreover, for certain types of securities, which finance specific projects contributing to environmental or social objectives the overall investment is considered to contribute to environmental and/or social objectives, but also for these a DNSH as well as a Good Governance check for issuers is performed.

- **How do the sustainable investments that the financial product partially intends to make, not cause significant harm to any environmental or social sustainable investment objective?**

In order to ensure that Sustainable Investments do not significantly harm any other environmental and/or social objective, the Investment Manager is leveraging the PAI indicators, whereby significance thresholds have been defined to identify significantly harmful issuers. Issuers not meeting the significance threshold can be engaged for a limited time period to remediate the adverse impact. Otherwise, if the issuer does not meet the defined significance thresholds twice subsequently or in case of a failed engagement, it does not pass the DNSH assessment. Investments in securities of issuers which do not pass the DNSH assessment are not counted as sustainable investments.

- *How have the indicators for adverse impacts on sustainability factors been taken into account?*

All mandatory PAI indicators are considered either as part of the application of the exclusion criteria or through thresholds on a sectorial or absolute basis. Significance thresholds have been defined and they refer to qualitative or quantitative criteria.

Recognizing the lack of data coverage for some of the PAI indicators equivalent data points are used to assess PAI indicators when applying the DNSH assessment, when relevant, for the following indicators for corporates: share of non-renewable energy consumption and production, activities negatively affecting biodiversity-sensitive areas, emissions to water, lack of processes and compliance mechanisms to monitor compliance with UNGC principles and OECD Guidelines for Multinational Enterprises; for sovereigns: GHG Intensity and investee countries subject to social violations. In case of securities which finance specific projects contributing to environmental or social objectives equivalent data at project level might be used to ensure that Sustainable Investments do not significantly harm any other environmental and/or social objective. The Investment Manager will strive to increase data coverage for PAI indicators with low data coverage by engaging with issuers and data providers. The Investment Manager will regularly evaluate whether the availability of data has increased sufficiently to potentially include assessment of such data in the investment process.

- *How are the sustainable investments aligned with the OECD Guidelines for Multinational Enterprises and the UN Guiding Principles on Business and Human Rights? Details:*

The Investment Manager's sustainable minimum exclusion list screens out companies based on their involvement in controversial practices against international norms. The core normative framework consists of the Principles of the UN Global Compact, the OECD Guidelines for Multinational Enterprises

Principal adverse impacts are the most significant negative impacts of investment decisions on sustainability factors relating to environmental, social and employee matters, respect for human rights, anti-corruption and anti-bribery matters.

and the UN Guiding Principles for Business and Human Rights. Securities issued by companies having a severe violation of these frameworks will be restricted from the investment universe.

The EU Taxonomy sets out a “do not significant harm” principle by which Taxonomy-aligned investments should not significantly harm EU Taxonomy objectives and is accompanied by specific EU criteria.

The “do not significant harm” principle applies only to those investments underlying the financial product that take into account the EU criteria for environmentally sustainable economic activities. The investments underlying the remaining portion of this financial product do not take into account the EU criteria for environmentally sustainable economic activities.

Any other sustainable investments must also not significantly harm any environmental or social objectives.



Does this financial product consider principal adverse impacts on sustainability factors?

Yes

No

The Management Company has joined the Net Zero Asset Manager Initiative and considers PAI indicators through stewardship including engagement, both are relevant to mitigate potential adverse impact as a company.

Due to the commitment to the Net Zero Asset Manager Initiative, the Management Company aims to reduce greenhouse gas emissions in partnership with asset owner clients on decarbonisation goals, consistent with an ambition to reach net zero emission by 2050 or sooner across all assets under management. As part of this objective the Management Company will set an interim target for the proportion of assets to be managed in line with the attainment of net zero emissions by 2050 or sooner.

The Sub-Fund’s Investment Manager considers PAI indicators regarding greenhouse gas emission, biodiversity, water, waste as well as social and employee matters for corporate issuers, and, where relevant, the freedom house index is applied to investments in sovereigns. PAI indicators are considered within the Investment Manager’s investment process through the means of exclusions as described in the “binding elements” section of the Sub-Fund.

The data coverage for the data required for the PAI indicators is heterogenous. The data coverage related to biodiversity, water and waste is low and the related PAI indicators are considered through exclusion of securities issued by companies having a severe violation / breach of principles and guidelines such as the Principles of the United Nations Global Compact, the OECD Guidelines for Multinational Enterprises, and the United Nations Guiding Principles for Business and Human Rights on the grounds of problematic practices around human rights, labour rights, environment, and corruption issues. Therefore, the Investment Manager will strive to increase data coverage for PAI indicators with low data coverage. The Investment Manager will regularly evaluate whether the availability of data has increased sufficiently to potentially include assessment of such data in the investment process.

Additionally, PAI indicators are, among other sustainability factors, applied to derive the SRI Rating. The SRI Rating is used for the portfolio construction.

The following PAI indicators are considered:

Applicable to corporate issuers

- GHG Emissions
- Carbon footprint
- GHG Intensity of investee companies
- Exposure to companies active in the fossil fuel sector
- Activities negatively affecting biodiversity-sensitive areas
- Emissions to water
- Hazardous waste ratio
- Violation of UN Global compact principles
- Lack of processes and compliance mechanisms to monitor compliance with UN Global Compact principles
- Board gender diversity
- Exposure to controversial weapons

Applicable to sovereign and supranational issuers

- Investee countries subject to social violations

The information on the PAI indicators will be available in the end-year report of the Sub-Fund.



The investment strategy guides investment decisions based on factors such as investment objectives and risk tolerance.

What investment strategy does this financial product follow?

Allianz Advanced Fixed Income Short Duration's investment objective is to invest in global Bond Markets with Euro exposure in accordance with the Sustainable and Responsible Investment Strategy (SRI Strategy).

As part of the SRI best-in-class approach, the Sub-Fund takes environmental, social, human rights, governance, and business behaviour factors into account as follows:

- The aforesaid sustainability factors are analysed through SRI Research by the Investment Manager in order to assess how sustainable development and long-term issues are taken into account in the strategy of an issuer. SRI Research means the overall process of identifying potential risks as well as potential opportunities of an investment in securities of an issuer related to the analysis of sustainability factors. SRI Research data combines external research data (which might have some limitations) with internal analyses.
- Based on a combination of the results of the external and/or internal analyses of the sustainability factors, an internal rating is derived monthly (SRI Rating) and is afterwards assigned to a corporate or sovereign issuer.

This internal SRI Rating is used to rank and select or weight securities for the portfolio construction.

The Sub-Fund's general investment approach (Sub-Fund's applicable General Asset Class Principles in combination with its individual investment restrictions) is described in the prospectus.

● What are the binding elements of the investment strategy used to select the investments to attain each of the environmental or social characteristics promoted by this financial product?

The binding elements are:

- Minimum rating coverage: At least 90% of the Sub-Fund's portfolio is required to have an SRI Rating (portfolio in this respect does not comprise non-rated derivatives and instruments that are non-rated by nature e.g., cash and deposits). While most holdings of the Sub-Fund will have a corresponding SRI Rating some investments cannot be rated according to the SRI Research methodology. Examples of instruments not attaining to the SRI Rating include, but are not limited to cash, deposits, Target Funds, and non-rated investments.
- The rated instruments are adhering to the minimum rating threshold of 1 (out of a rating scale from 0 – 4; 0 being the worst rating and 4 the best rating).
- Application of the following sustainable minimum exclusion criteria for direct investments:
 - securities issued by companies having a severe violation / breach of principles and guidelines such as the Principles of the United Nations Global Compact, the OECD Guidelines for Multinational Enterprises, and the United Nations Guiding Principles for Business and Human Rights on the grounds of problematic practices around human rights, labour rights, environment, and corruption issues,
 - securities issued by companies involved in controversial weapons (anti-personnel mines, cluster munitions, chemical weapons, biological weapons, depleted uranium, white phosphorus, and nuclear weapons),
 - securities issued by companies that derive more than 10% of their revenues from weapons, military equipment, and services,
 - securities issued by companies that derive more than 10% of their revenue from thermal coal extraction,
 - securities issued by utility companies that generate more than 20% of their revenues from coal,
 - securities issued by companies involved in the production of tobacco, and securities issued by companies involved in the distribution of tobacco with more than 5% of their revenues.

Direct investments in sovereign issuers with an insufficient freedom house index score are excluded.

The sustainable minimum exclusion criteria are based on information from an external data provider and coded in pre- and post-trade compliance. The review is performed at least half yearly.

- **What is the committed minimum rate to reduce the scope of the investments considered prior to the application of that investment strategy?**

The Sub-Fund does not commit to reduce the scope of the investments by a certain minimum rate.

- **What is the policy to assess good governance practices of the investee companies?**

Good governance principles are considered by screening out companies based on their involvement in controversies around international norms corresponding to the four good governance practices: sound management structures, employee relations, remuneration of staff and tax compliance. Companies having a severe violation in either of those areas will not be investible. For certain cases, flagged issuers shall be on a watch list. These companies will appear on this watch list when the Investment Manager believes that engagement may lead to improvements or when the company is assessed to take remedial actions. Companies on the watch list remain investible unless the Investment Manager believes that the engagement or the remedial actions of the company does not lead to the desired remedy of the severe controversy.

In addition, the Sub-Fund's Investment Manager is committed to actively encourage open dialogues with investee companies on corporate governance, proxy voting and broader sustainability issues in advance of shareholder meetings (regularly for direct investments in shares). The Sub-Fund's Investment Manager's approach to proxy voting and company engagement is set out in the Management Company's Stewardship Statement.

Good governance practices include sound management structures, employee relations, remuneration of staff and tax compliance.



What is the asset allocation planned for this financial product?

Asset allocation describes the share of investments in specific assets.

Min. 90% of the Sub-Funds' assets (excluding cash and non-rated derivatives) are used to meet the environmental or social characteristics promoted by this Sub-Fund. A low portion of the Sub-Fund might contain assets which do not promote environmental or social characteristics. Examples of such instruments are derivatives, cash and deposits, some Target Funds and investment with temporarily divergent or absent environmental, social, or good governance qualifications. Min. 10% of the Sub-Funds' assets will be invested in Sustainable Investments. The minimum percentage of investments that are aligned with the EU Taxonomy is 0.01%. The Sub-Fund's Investment Manager does not commit to a minimum share of environmentally Sustainable Investments that are not aligned with the EU Taxonomy. The Sub-Fund's Investment Manager does not commit to a minimum share of socially sustainable investments. While the Sub-Fund cannot commit to a minimum share of environmentally or socially sustainable investments, such investments may be freely allocated to within the Sub-Fund aggregated sustainable investment commitment disclosed (min. 10%).

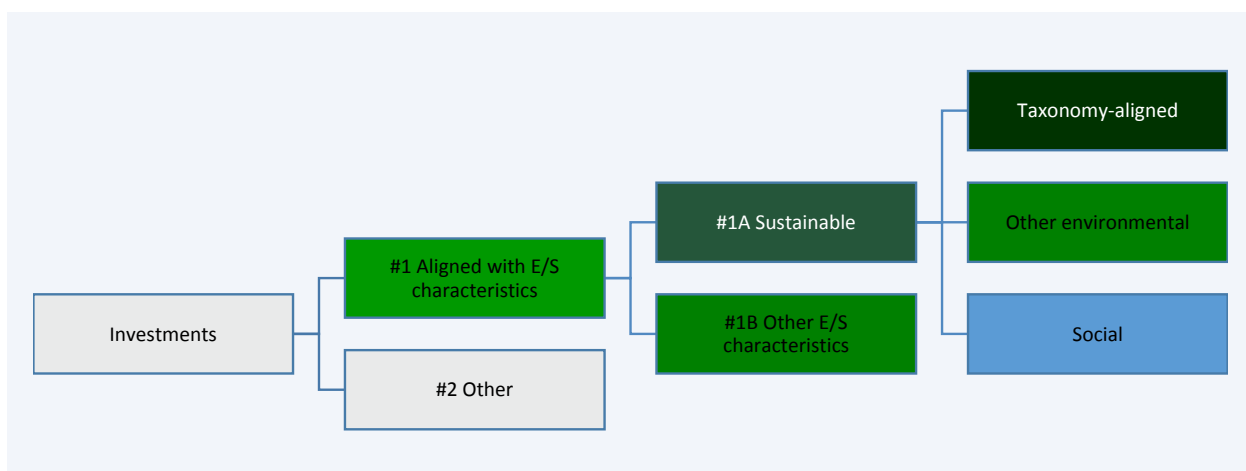

#1 Aligned with E/S characteristics includes the investments of the financial product used to attain the environmental or social characteristics promoted by the financial product.

#2 Other includes the remaining investments of the financial product which are neither aligned with the environmental or social characteristics, nor are qualified as sustainable investments.

The category **#1 Aligned with E/S characteristics** covers:

- The sub-category **#1A Sustainable** covers sustainable investments with environmental or social objectives.
- The sub-category **#1B Other E/S characteristics** covers investments aligned with the environmental or social characteristics that do not qualify as sustainable investments.

- How does the use of derivatives attain the environmental or social characteristics promoted by the financial product?

Not applicable



To what minimum extent are sustainable investments with an environmental objective aligned with the EU Taxonomy?

The Taxonomy-aligned investments include debt and/or equity in environmentally sustainable economic activities aligned with the EU-Taxonomy. The minimum percentage of investments that are aligned with the EU Taxonomy is 0.01%. Taxonomy-aligned data is provided by an external data provider. The Investment Manager has assessed the quality of such data. The data will not be subject to an assurance provided by auditors or a review by third parties. The data will not reflect any data in government bonds. As of today, there is no recognized methodology available to determine the proportion of Taxonomy-aligned activities when investing in government bonds.

Taxonomy-aligned activities in this disclosure are based on share of turnover. Pre-contractual figures use turnover as its financial metric as a default in line with the regulatory requirements and based on the fact that complete, verifiable or up-to date data for CAPEX and/or OPEX as financial metric is even less available.

Taxonomy-aligned data is only in rare cases data reported by companies in accordance with the EU Taxonomy. The data provider has derived Taxonomy-aligned data from other available equivalent public data.

- Does the financial product invest in fossil gas and/or nuclear energy related activities that comply with the EU Taxonomy ¹?

Yes:

In fossil gas In nuclear energy

No

The Sub-Fund does not pursue any investments in fossil gas and/or nuclear energy related activities that comply with the EU Taxonomy. Nevertheless, as result of this investment strategy, investments may occur in corporates which are also active in these activities. Further information will be provided as part of the annual reporting, if relevant.

The two graphs below show in green the minimum percentage of investments that are aligned with the EU Taxonomy. As there is no appropriate methodology to determine the Taxonomy-alignment of sovereign bonds*, the first graph shows the Taxonomy-alignment in relation to all the investments of the financial product including sovereign bonds, while the second graph shows the Taxonomy-alignment only in relation to the investments of the financial product other than sovereign bonds.

1. Taxonomy-alignment of investments including sovereign bonds*

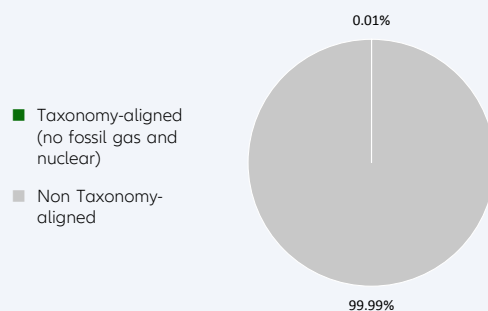

2. Taxonomy-alignment of investments excluding sovereign bonds*

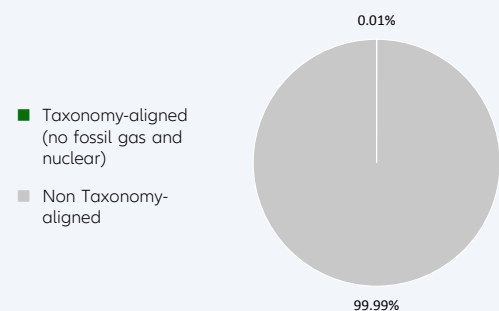

This graph represents X% of the total investments. It is noted that this Sub-Fund does not provide for a binding minimum quota for investments in sovereign bonds. Therefore, this Sub-Fund may have (but must not have) an exposure to sovereign bonds. In the absence of a binding minimum quota for investments in sovereign

Taxonomy-aligned activities are expressed as a share of:

- **turnover** reflecting the share of revenue from green activities of investee companies
- **capital expenditure** (CapEx) showing the green investments made by investee companies, e.g. for a transition to a green economy.
- **operational expenditure** (OpEx) reflecting green operational activities of investee companies.

¹ Fossil gas and/or nuclear related activities will only comply with the EU Taxonomy where they contribute to limiting climate change ("climate change mitigation") and do not significantly harm any EU Taxonomy objective - see explanatory note in the left hand margin. The full criteria for fossil gas and nuclear energy economic activities that comply with the EU Taxonomy are laid down in Commission Delegated Regulation (EU) 2022/1214.

bonds, this graph does not generate any additional added value compared to the left-hand graph.

* For the purpose of these graphs, 'sovereign bonds' consist of all sovereign exposures

Enabling activities directly enable other activities to make a substantial contribution to an environmental objective.

Transitional activities are activities for which low-carbon alternatives are not yet available and among others have greenhouse gas emission levels corresponding to the best performance.

● **What is the minimum share of investments in transitional and enabling activities?**

The Sub-Fund's Investment Manager does not commit to a split of minimum taxonomy alignment into transitional, enabling activities and own performance.



What is the minimum share of sustainable investments with an environmental objective that are not aligned with the EU Taxonomy?

Taxonomy-aligned investments are considered a sub-category of Sustainable Investments. If an investment is not Taxonomy-aligned since the activity is not yet covered under the EU Taxonomy or the positive contribution is not substantial enough to comply with the Taxonomy technical screening criteria, the investment can still be considered an environmentally Sustainable Investment provided it complies with all criteria. The Investment Manager does not commit to a minimum share of environmentally Sustainable Investments that are not aligned with the EU Taxonomy. The overall sustainable investment share may also include investments with an environmental objective in economic activities that do not qualify as environmentally sustainable under the EU Taxonomy, and while the Sub-Fund cannot commit to a minimum share of environmentally or socially sustainable investments, such investments may be freely allocated to within the Sub-Fund aggregated sustainable investment commitment disclosed (min 10%).



are sustainable investments with an environmental objective that **do not take into account the criteria** for environmentally sustainable economic activities under the EU Taxonomy.



What is the minimum share of socially sustainable investments?

The Investment Manager defines Sustainable Investments based on internal research, which uses, among others, the UN Sustainable Development Goals (SDGs), as well as the objectives of the EU Taxonomy as reference frameworks. The Investment Manager does not commit to a minimum share of socially Sustainable Investments, as the SDGs contain environmental as well as social objectives. The overall sustainable investment share may also include investments with a social objective, and while the Sub-Fund cannot commit to a minimum share of environmentally or socially sustainable investments, such investments may be freely allocated to within the Sub-Fund aggregated sustainable investment commitment disclosed (min 10%).



What investments are included under “#2 Other”, what is their purpose and are there any minimum environmental or social safeguards?

Under “#2 Other” investments into cash, Target Funds, or derivatives can be included. Derivatives might be used for efficient portfolio management (including risk hedging) and/or investment purposes, and Target Funds to benefit from a specific strategy. For those investments no environmental or social safeguards are applied.



Is a specific index designated as a reference benchmark to determine whether this financial product is aligned with the environmental and/or social characteristics that it promotes?

No reference benchmark has been designated for the purpose of attaining the environmental and/or social characteristics promoted by the Sub-Fund.

Reference benchmarks are indexes to measure whether the financial product attains the environmental or social characteristics that they promote.

- **How is the reference benchmark continuously aligned with each of the environmental or social characteristics promoted by the financial product?**
Not applicable
- **How is the alignment of the investment strategy with the methodology of the index ensured on a continuous basis?**
Not applicable
- **How does the designated index differ from a relevant broad market index?**
Not applicable
- **Where can the methodology used for the calculation of the designated index be found?**
Not applicable



Where can I find more product specific information online?

More product-specific information can be found on the website: <https://regulatory.allianzgi.com/SFDR>

Template pre-contractual disclosure for the financial products referred to in Article 8, paragraphs 1, 2 and 2a, of Regulation (EU) 2019/2088 and Article 6, first paragraph, of Regulation (EU) 2020/852

Product name:

Allianz All China Equity

Legal entity identifier: 529900RSE3ISUYS6ZL79

Environmental and/or social characteristics

Sustainable investment means an investment in an economic activity that contributes to an environmental or social objective, provided that the investment does not significantly harm any environmental or social objective and that the investee companies follow good governance practices.

The **EU Taxonomy** is a classification system laid down in Regulation (EU) 2020/852, establishing a list of **environmentally sustainable economic activities**. That Regulation does not include a list of socially sustainable economic activities. Sustainable investments with an environmental objective might be aligned with the Taxonomy or not.

Does this financial product have a sustainable investment objective?	
Yes	No
<input type="checkbox"/> It will make a minimum of sustainable investments with an environmental objective : ___% <input type="checkbox"/> in economic activities that qualify as environmentally sustainable under the EU Taxonomy <input type="checkbox"/> in economic activities that do not qualify as environmentally sustainable under the EU Taxonomy	<input checked="" type="checkbox"/> It promotes Environmental/Social (E/S) characteristics and while it does not have as its objective a sustainable investment, it will have a minimum proportion of 5.00% of sustainable investments <input checked="" type="checkbox"/> with an environmental objective in economic activities that qualify as environmentally sustainable under the EU Taxonomy <input checked="" type="checkbox"/> with an environmental objective in economic activities that do not qualify as environmentally sustainable under the EU Taxonomy <input checked="" type="checkbox"/> with a social objective
<input type="checkbox"/> It will make a minimum of sustainable investments with a social objective ___%	<input type="checkbox"/> It promotes E/S characteristics, but will not make any sustainable investments



What environmental and/or social characteristics are promoted by this financial product?

Allianz All China Equity (the "Sub-Fund") promotes Environment, Social and Governance factors through the ESG Score Strategy. The ESG Score Strategy aims to measure a company's resilience to long-term risks across the three pillars of Environment, Social and Governance. ESG pillars will be addressed by outperforming the Weighted Average ESG Score of issuers whose shares have been acquired by the Sub-Fund against the Weighted Average ESG Score of issuers which are components of Sub-Fund's benchmark.

In addition, sustainable minimum exclusion criteria apply.

A reference benchmark has been designated for the purpose of attaining the environmental or social characteristics promoted by the Sub-Fund.

What sustainability indicators are used to measure the attainment of each of the environmental or social characteristics promoted by this financial product?

To measure the attainment of the environmental and/or social characteristics the following sustainability indicators are used and reported on, at the fiscal year end:

- The actual percentage of ESG Score coverage of the Sub-Fund's Portfolio (Portfolio in this respect does not comprise derivatives and instruments that are non-evaluated by nature (e. g., cash and deposits)).
- The weighted average ESG Score of the portfolio vs the weighted average ESG Score of the benchmark

Sustainability indicators measure how the environmental or social characteristics promoted by the financial product are attained.

- Confirmation that Principal Adverse Impacts (PAIs) of investment decisions on sustainability factors are considered through the application of exclusion criteria.

- **What are the objectives of the sustainable investments that the financial product partially intends to make and how does the sustainable investment contribute to such objectives?**

Sustainable investments contribute to environmental and/or social objectives, for which the Investment Manager uses as reference frameworks, among others, the UN Sustainable Development Goals (SDGs), as well as the objectives of the EU Taxonomy:

1. Climate Change Mitigation
2. Climate Change Adaptation
3. Sustainable Use and Protection of Water and Marine Resources
4. Transition to a Circular Economy
5. Pollution Prevention and Control
6. Protection and Restoration of Biodiversity and Ecosystems

The assessment of the positive contribution to the environmental or social objectives is based on a proprietary framework which combines quantitative elements with qualitative inputs from internal research. The methodology applies first a quantitative breakdown of a securities issuer into its business activities. The qualitative element of the framework is an assessment if business activities contribute positively to an environmental or a social objective.

To calculate the positive contribution on the Sub-Fund level the revenue share of each issuer attributable to business activities contributing to environmental and/or social objectives is considered provided the issuer is satisfying the Do No Significant Harm (“DNSH”) and Good Governance principles, and an asset-weighted aggregation is performed as a second step. Moreover, for certain types of securities, which finance specific projects contributing to environmental or social objectives the overall investment is considered to contribute to environmental and/or social objectives, but also for these a DNSH as well as a Good Governance check for issuers is performed.

- **How do the sustainable investments that the financial product partially intends to make, not cause significant harm to any environmental or social sustainable investment objective?**

In order to ensure that Sustainable Investments do not significantly harm any other environmental and/or social objective, the Investment Manager is leveraging the PAI indicators, whereby significance thresholds have been defined to identify significantly harmful issuers. Issuers not meeting the significance threshold can be engaged for a limited time period to remediate the adverse impact. Otherwise, if the issuer does not meet the defined significance thresholds twice subsequently or in case of a failed engagement, it does not pass the DNSH assessment. Investments in securities of issuers which do not pass the DNSH assessment are not counted as sustainable investments.

- *How have the indicators for adverse impacts on sustainability factors been taken into account?*

All mandatory PAI indicators are considered either as part of the application of the exclusion criteria or through thresholds on a sectorial or absolute basis. Significance thresholds have been defined and they refer to qualitative or quantitative criteria.

Recognizing the lack of data coverage for some of the PAI indicators equivalent data points are used to assess PAI indicators when applying the DNSH assessment, when relevant, for the following indicators for corporates: share of non-renewable energy consumption and production, activities negatively affecting biodiversity-sensitive areas, emissions to water, lack of processes and compliance mechanisms to monitor compliance with UNGC principles and OECD Guidelines for Multinational Enterprises; for sovereigns: GHG Intensity and investee countries subject to social violations. In case of securities which finance specific projects contributing to environmental or social objectives equivalent data at project level might be used to ensure that Sustainable Investments do not significantly harm any other environmental and/or social objective. The Investment Manager will strive to increase data coverage for PAI indicators with low data coverage by engaging with issuers and data providers. The Investment Manager will regularly evaluate whether the availability of data has increased sufficiently to potentially include assessment of such data in the investment process.

Principal adverse impacts are the most significant negative impacts of investment decisions on sustainability factors relating to environmental, social and employee matters, respect for human rights, anti-corruption and anti-bribery matters.

- *How are the sustainable investments aligned with the OECD Guidelines for Multinational Enterprises and the UN Guiding Principles on Business and Human Rights? Details:*

The Investment Manager's sustainable minimum exclusion list screens out companies based on their involvement in controversial practices against international norms. The core normative framework consists of the Principles of the UN Global Compact, the OECD Guidelines for Multinational Enterprises and the UN Guiding Principles for Business and Human Rights. Securities issued by companies having a severe violation of these frameworks will be restricted from the investment universe.

The EU Taxonomy sets out a "do not significant harm" principle by which Taxonomy-aligned investments should not significantly harm EU Taxonomy objectives and is accompanied by specific EU criteria.

The "do not significant harm" principle applies only to those investments underlying the financial product that take into account the EU criteria for environmentally sustainable economic activities. The investments underlying the remaining portion of this financial product do not take into account the EU criteria for environmentally sustainable economic activities.

Any other sustainable investments must also not significantly harm any environmental or social objectives.



Does this financial product consider principal adverse impacts on sustainability factors?

Yes

No

The Management Company has joined the Net Zero Asset Manager Initiative and considers PAI indicators through stewardship including engagement, both are relevant to mitigate potential adverse impact as a company.

Due to the commitment to the Net Zero Asset Manager Initiative, the Management Company aims to reduce greenhouse gas emissions in partnership with asset owner clients on decarbonisation goals, consistent with an ambition to reach net zero emission by 2050 or sooner across all assets under management. As part of this objective the Management Company will set an interim target for the proportion of assets to be managed in line with the attainment of net zero emissions by 2050 or sooner.

The Sub-Fund's Investment Manager addresses PAI indicators regarding greenhouse gas emission, biodiversity, water, waste as well as social and employee matters for corporate issuers, and, where relevant, the freedom house index is applied to investments in sovereigns. PAI indicators are considered within the Investment Manager's investment process through the means of exclusions as described in the "binding elements" section of the Sub-Fund.

The data coverage for the data required for the PAI indicators is heterogenous. The data coverage related to biodiversity, water and waste is low and the related PAI indicators are considered through exclusion of securities issued by companies having a severe violation / breach of principles and guidelines such as the Principles of the United Nations Global Compact, the OECD Guidelines for Multinational Enterprises, and the United Nations Guiding Principles for Business and Human Rights on the grounds of problematic practices around human rights, labour rights, environment, and corruption issues. Therefore, the Investment Manager will strive to increase data coverage for PAI indicators with low data coverage. The Investment Manager will regularly evaluate whether the availability of data has increased sufficiently to potentially include assessment of such data in the investment process.

Additionally, PAI indicators are, among other sustainability factors, applied in the ESG Score. The ESG Score is used for the portfolio construction.

The following PAI indicators are considered:

Applicable to corporate issuers

- GHG Emissions
- Carbon footprint
- GHG Intensity of investee companies
- Exposure to companies active in the fossil fuel sector
- Activities negatively affecting biodiversity-sensitive areas
- Emissions to water
- Hazardous waste ratio

- Violation of UN Global compact principles
- Lack of processes and compliance mechanisms to monitor compliance with UN Global Compact principles
- Board gender diversity
- Exposure to controversial weapons

Applicable to sovereign and supranational issuers

- Investee countries subject to social violations

The information on the PAI indicators will be available in the end-year report of the Sub-Fund.



What investment strategy does this financial product follow?

The investment strategy guides investment decisions based on factors such as investment objectives and risk tolerance.

Allianz All China Equity's investment objective is to invest in onshore and offshore PRC, Hong Kong and Macau equity markets in accordance with the ESG Score Strategy. The Sub-Fund promotes Environment, Social and Governance factors through the ESG Score Strategy. Aim of the strategy is to outperform the weighted average ESG Score against its benchmark. The outperformance is determined as the excess between the Sub-Fund's weighted average ESG Score and the Sub-Fund's benchmark weighted average ESG Score. The ESG Score is comprised of the pillars Environment, Social and Governance. The portfolio and benchmark weights are rebased such that only issuers with ESG Scores available are considered in the calculation.

The proportion of assets which do not have a ESG Score is expected to be low. Examples of instruments not having a ESG Score are cash and deposits, some Target Funds, and investments for which the ESG Score is deemed to be not appropriate and/or data is not available.

The Sub-Fund's general investment approach (Sub-Fund's applicable General Asset Class Principles in combination with its individual investment restrictions) is described in the prospectus.

● What are the binding elements of the investment strategy used to select the investments to attain each of the environmental or social characteristics promoted by this financial product?

The investment strategy adheres to the following binding elements to attain the environmental and/ or social characteristics promoted:

- Min. 80% ESG Score coverage of the Sub-Fund's Portfolio (Portfolio in this respect does not comprise derivatives and instruments that are non-evaluated by nature (e. g., cash and deposits)).
- Outperformance of benchmark in terms of weighted average ESG Score.
- Application of the following sustainable minimum exclusion criteria for direct investments:
 - securities issued by companies having a severe violation / breach of principles and guidelines such as the Principles of the United Nations Global Compact, the OECD Guidelines for Multinational Enterprises, and the United Nations Guiding Principles for Business and Human Rights on the grounds of problematic practices around human rights, labour rights, environment, and corruption,
 - securities issued by companies involved in controversial weapons (anti-personnel mines, cluster munitions, chemical weapons, biological weapons, depleted uranium, white phosphorus, and nuclear weapons),
 - securities issued by companies that derive more than 10% of their revenues from weapons, military equipment, and services,
 - securities issued by companies that derive more than 10% of their revenue from thermal coal extraction
 - securities issued by utility companies that generate more than 20% of their revenues from coal,
 - securities issued by companies involved in the production of tobacco, and securities issued by companies involved in the distribution of tobacco with more than 5% of their revenues.

Direct investments in sovereign issuers with an insufficient freedom house index score are excluded.

The sustainable minimum exclusion criteria are based on information from an external data provider and coded in pre- and post-trade compliance. The review is performed at least half yearly.

- **What is the committed minimum rate to reduce the scope of the investments considered prior to the application of that investment strategy?**

The Sub-Fund does not commit to reduce the scope of the investments by a certain minimum rate.

- **What is the policy to assess good governance practices of the investee companies?**

Good governance principles are considered by screening out companies based on their involvement in controversies around international norms corresponding to the four good governance practices: sound management structures, employee relations, remuneration of staff and tax compliance. Companies having a severe violation in either of those areas will not be investible. For certain cases, flagged issuers shall be on a watch list. These companies will appear on this watch list when the Investment Manager believes that engagement may lead to improvements or when the company is assessed to take remedial actions. Companies on the watch list remain investible unless the Investment Manager believes that the engagement or the remedial actions of the company does not lead to the desired remedy of the severe controversy.

In addition, the Sub-Fund's Investment Manager is committed to actively encourage open dialogues with investee companies on corporate governance, proxy voting and broader sustainability issues in advance of shareholder meetings (regularly for direct investments in shares). The Sub-Fund's Investment Manager's approach to proxy voting and company engagement is set out in the Management Company's Stewardship Statement.

Good governance practices include sound management structures, employee relations, remuneration of staff and tax compliance.



What is the asset allocation planned for this financial product?

Asset allocation describes the share of investments in specific assets.

Min. 80% of the Sub-Funds' assets (excluding cash, and derivatives) are used to meet the environmental or social characteristics promoted by this Sub-Fund. A low portion of the Sub-Fund might contain assets which do not promote environmental or social characteristics. Example of such instruments are derivatives, cash and deposits, some Target Funds and investment with temporarily divergent or absent environmental, social, or good governance qualifications. Min. 5% of the Sub-Funds' assets will be invested in Sustainable Investments. The Sub-Fund's Investment Manager does not commit to a minimum share of sustainable investments with an environmental objective aligned with the EU Taxonomy nor to a minimum share of environmentally Sustainable Investments that are not aligned with the EU Taxonomy. The Sub-Fund's Investment Manager does not commit to a minimum share of socially sustainable investments. While the Sub-Fund cannot commit to a minimum share of environmentally or socially sustainable investments, such investments may be freely allocated to within the Sub-Fund aggregated sustainable investment commitment disclosed (min. 5%).

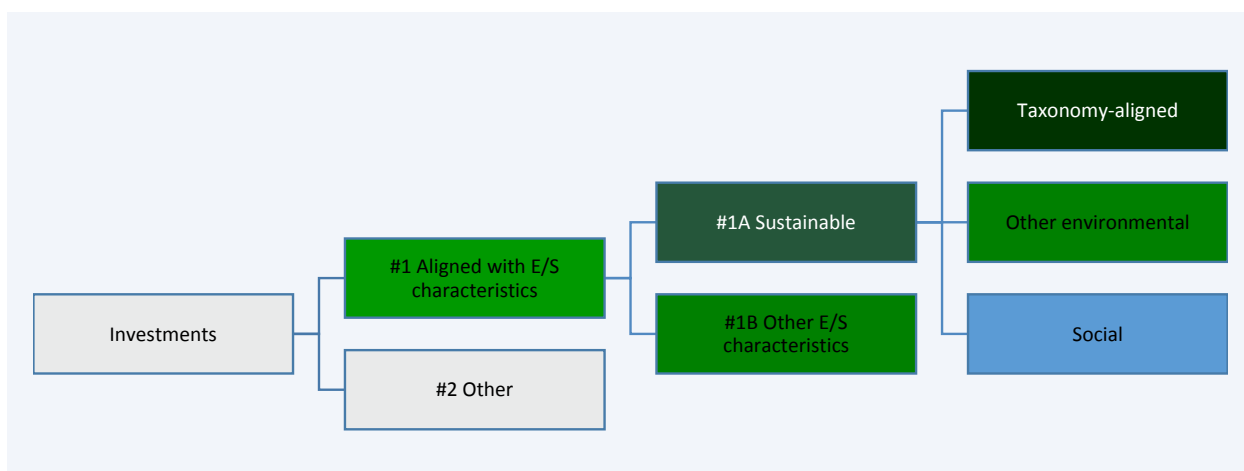

#1 Aligned with E/S characteristics includes the investments of the financial product used to attain the environmental or social characteristics promoted by the financial product.

#2 Other includes the remaining investments of the financial product which are neither aligned with the environmental or social characteristics, nor are qualified as sustainable investments.

The category **#1 Aligned with E/S characteristics** covers:

- The sub-category **#1A Sustainable** covers sustainable investments with environmental or social objectives.
- The sub-category **#1B Other E/S characteristics** covers investments aligned with the environmental or social characteristics that do not qualify as sustainable investments.

- How does the use of derivatives attain the environmental or social characteristics promoted by the financial product?

Not applicable



To what minimum extent are sustainable investments with an environmental objective aligned with the EU Taxonomy?

The Sub-Fund's Investment Manager does not commit to a minimum share of sustainable investments with an environmental objective aligned with the EU Taxonomy. The overall sustainable investment share may also include investments with an environmental objective in economic activities that qualify as environmentally sustainable under the EU Taxonomy.

- Does the financial product invest in fossil gas and/or nuclear energy related activities that comply with the EU Taxonomy¹?

- Yes:
- In fossil gas
 - In nuclear energy
- No

The Sub-Fund does not pursue any investments in fossil gas and/or nuclear energy related activities that comply with the EU Taxonomy. Nevertheless, as result of this investment strategy, investments may occur in corporates which are also active in these activities. Further information will be provided as part of the annual reporting, if relevant.

The two graphs below show in green the minimum percentage of investments that are aligned with the EU Taxonomy. As there is no appropriate methodology to determine the Taxonomy-alignment of sovereign bonds*, the first graph shows the Taxonomy-alignment in relation to all the investments of the financial product including sovereign bonds, while the second graph shows the Taxonomy-alignment only in relation to the investments of the financial product other than sovereign bonds.

1. Taxonomy-alignment of investments including sovereign bonds*

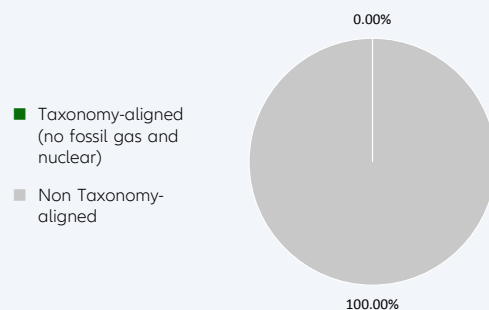

2. Taxonomy-alignment of investments excluding sovereign bonds*

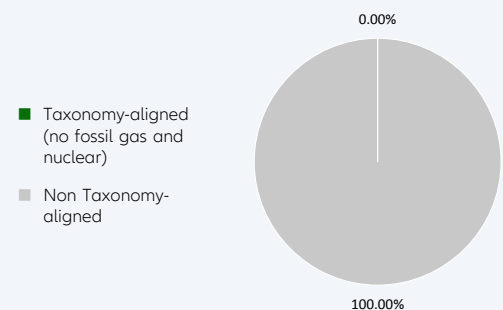

This graph represents X% of the total investments. It is noted that – due to the fact that this Sub-Fund does not provide for a minimum quota of taxonomy-aligned investments – this graph does not generate any additional added value compared to the left-hand graph.

* For the purpose of these graphs, 'sovereign bonds' consist of all sovereign exposures

- What is the minimum share of investments in transitional and enabling activities?

The Sub-Fund's Investment Manager does not commit to a split of minimum taxonomy alignment into transitional, enabling activities and own performance.

Taxonomy-aligned activities are expressed as a share of:

- **turnover** reflecting the share of revenue from green activities of investee companies
- **capital expenditure (CapEx)** showing the green investments made by investee companies, e.g. for a transition to a green economy.
- **operational expenditure (OpEx)** reflecting green operational activities of investee companies.

Enabling activities directly enable other activities to make a substantial contribution to an environmental objective.

Transitional activities are activities for which low-carbon alternatives are not yet available

¹ Fossil gas and/or nuclear related activities will only comply with the EU Taxonomy where they contribute to limiting climate change ("climate change mitigation") and do not significantly harm any EU Taxonomy objective - see explanatory note in the left hand margin. The full criteria for fossil gas and nuclear energy economic activities that comply with the EU Taxonomy are laid down in Commission Delegated Regulation (EU) 2022/1214.

and among others have greenhouse gas emission levels corresponding to the best performance.



What is the minimum share of sustainable investments with an environmental objective that are not aligned with the EU Taxonomy?

Taxonomy-aligned investments are considered a sub-category of Sustainable Investments. If an investment is not Taxonomy-aligned since the activity is not yet covered under the EU Taxonomy or the positive contribution is not substantial enough to comply with the Taxonomy technical screening criteria, the investment can still be considered an environmentally Sustainable Investment provided it complies with all criteria. The Investment Manager does not commit to a minimum share of environmentally Sustainable Investments that are not aligned with the EU Taxonomy. The overall sustainable investment share may also include investments with an environmental objective in economic activities that do not qualify as environmentally sustainable under the EU Taxonomy, and while the Sub-Fund cannot commit to a minimum share of environmentally or socially sustainable investments, such investments may be freely allocated to within the Sub-Fund aggregated sustainable investment commitment disclosed (min. 5%).



are sustainable investments with an environmental objective that **do not take into account the criteria** for environmentally sustainable economic activities under the EU Taxonomy.



What is the minimum share of socially sustainable investments?

The Investment Manager defines Sustainable Investments based on internal research, which uses, among others, the UN Sustainable Development Goals (SDGs), as well as the objectives of the EU Taxonomy as reference frameworks. The Investment Manager does not commit to a minimum share of socially Sustainable Investments, as the SDGs contain environmental as well as social objectives. The overall sustainable investment share may also include investments with a social objective, and while the Sub-Fund cannot commit to a minimum share of environmentally or socially sustainable investments, such investments may be freely allocated to within the Sub-Fund aggregated sustainable investment commitment disclosed (min. 5%).



What investments are included under “#2 Other”, what is their purpose and are there any minimum environmental or social safeguards?

Under “#2 Other” investments into cash, Target Funds, or derivatives can be included. Derivatives might be used for efficient portfolio management (including risk hedging) and/or investment purposes, and Target Funds to benefit from a specific strategy. For those investments no environmental or social safeguards are applied.



Is a specific index designated as a reference benchmark to determine whether this financial product is aligned with the environmental and/or social characteristics that it promotes?

Yes, the Sub-Fund has assigned the MSCI China All Shares Total Return Net as a benchmark. This benchmark is a market index. The Sub-Fund will promote environmental and social characteristics by outperforming the benchmark's Weighted ESG Score.

Reference benchmarks are indexes to measure whether the financial product attains the environmental or social characteristics that they promote.

- **How is the reference benchmark continuously aligned with each of the environmental or social characteristics promoted by the financial product?**

The benchmark is a market index and does not incorporate environmental or social characteristics for index construction.

- **How is the alignment of the investment strategy with the methodology of the index ensured on a continuous basis?**

The benchmark is not continuously aligned as it does not incorporate environmental or social characteristics for index construction.

- **How does the designated index differ from a relevant broad market index?**

The benchmark is a broad market index.

- **Where can the methodology used for the calculation of the designated index be found?**

Details of the Benchmark's methodology may be found at <https://www.msci.com/documents/10199/d84b06d0-b81c-48ce-89b8-c57f808065e4> or at www.msci.com



Where can I find more product specific information online?

More product-specific information can be found on the website: <https://regulatory.allianzgi.com/SFDR>

Template pre-contractual disclosure for the financial products referred to in Article 8, paragraphs 1, 2 and 2a, of Regulation (EU) 2019/2088 and Article 6, first paragraph, of Regulation (EU) 2020/852

Product name:

Allianz Best Styles Europe Equity SRI

Legal entity identifier: 529900CFHS19HK7S6O04

Environmental and/or social characteristics

Sustainable investment means an investment in an economic activity that contributes to an environmental or social objective, provided that the investment does not significantly harm any environmental or social objective and that the investee companies follow good governance practices.

The **EU Taxonomy** is a classification system laid down in Regulation (EU) 2020/852, establishing a list of **environmentally sustainable economic activities**. That Regulation does not include a list of socially sustainable economic activities. Sustainable investments with an environmental objective might be aligned with the Taxonomy or not.

Does this financial product have a sustainable investment objective?	
Yes	No
<input type="checkbox"/> It will make a minimum of sustainable investments with an environmental objective: ___% <ul style="list-style-type: none"> <input type="checkbox"/> in economic activities that qualify as environmentally sustainable under the EU Taxonomy <input type="checkbox"/> in economic activities that do not qualify as environmentally sustainable under the EU Taxonomy 	<input checked="" type="checkbox"/> It promotes Environmental/Social (E/S) characteristics and while it does not have as its objective a sustainable investment, it will have a minimum proportion of 30.00% of sustainable investments <ul style="list-style-type: none"> <input checked="" type="checkbox"/> with an environmental objective in economic activities that qualify as environmentally sustainable under the EU Taxonomy <input checked="" type="checkbox"/> with an environmental objective in economic activities that do not qualify as environmentally sustainable under the EU Taxonomy <input checked="" type="checkbox"/> with a social objective
<input type="checkbox"/> It will make a minimum of sustainable investments with a social objective ___%	<input type="checkbox"/> It promotes E/S characteristics, but will not make any sustainable investments



What environmental and/or social characteristics are promoted by this financial product?

Allianz Best Styles Europe Equity SRI (the "Sub-Fund") promotes environmental, social, human rights, governance, and business behaviour factors (this domain does not apply for sovereigns issued by a Sovereign Entity) through integration of a best-in-class approach into the Sub-Fund's investment process. This encompasses the evaluation of corporate or sovereign issuers based on an SRI Rating which is used to construct the portfolio.

In addition, sustainable minimum exclusion criteria and Sub-Fund specific exclusion criteria apply.

A reference benchmark has been designated for the purpose of attaining the environmental and/or social characteristics promoted by the Sub-Fund.

What sustainability indicators are used to measure the attainment of each of the environmental or social characteristics promoted by this financial product?

To measure the attainment of the environmental and/or social characteristics the following sustainability indicators are used and reported on, at the fiscal year end:

- The actual percentage of the Sub-Fund's Portfolio (Portfolio in this respect does not comprise non-rated derivatives and instruments that are non-rated by nature (e. g., cash and deposits)) assets invested in best-in-class issuers (issuers with a minimum SRI Rating of 1 out of a scale from 0-4; 0 being the worst rating and 4 the best rating) is compared to the actual percentage of the benchmarks best-in-class issuers.
- Adherence to a 20% reduction of the investment universe

Sustainability indicators measure how the environmental or social characteristics promoted by the financial product are attained.

- Confirmation that Principal Adverse Impacts (PAIs) of investment decisions on sustainability factors are considered through the application of exclusion criteria.
- **What are the objectives of the sustainable investments that the financial product partially intends to make and how does the sustainable investment contribute to such objectives?**

Sustainable investments contribute to environmental and/or social objectives, for which the Investment Manager uses as reference frameworks, among others, the UN Sustainable Development Goals (SDGs), as well as the objectives of the EU Taxonomy:

1. Climate Change Mitigation
2. Climate Change Adaptation
3. Sustainable Use and Protection of Water and Marine Resources
4. Transition to a Circular Economy
5. Pollution Prevention and Control
6. Protection and Restoration of Biodiversity and Ecosystems

The assessment of the positive contribution to the environmental or social objectives is based on a proprietary framework which combines quantitative elements with qualitative inputs from internal research. The methodology applies first a quantitative breakdown of a securities issuer into its business activities. The qualitative element of the framework is an assessment if business activities contribute positively to an environmental or a social objective.

To calculate the positive contribution on the Sub-Fund level the revenue share of each issuer attributable to business activities contributing to environmental and/or social objectives is considered provided the issuer is satisfying the Do No Significant Harm (“DNSH”) and Good Governance principles, and an asset-weighted aggregation is performed as a second step. Moreover, for certain types of securities, which finance specific projects contributing to environmental or social objectives the overall investment is considered to contribute to environmental and/or social objectives, but also for these a DNSH as well as a Good Governance check for issuers is performed.

- **How do the sustainable investments that the financial product partially intends to make, not cause significant harm to any environmental or social sustainable investment objective?**

In order to ensure that Sustainable Investments do not significantly harm any other environmental and/or social objective, the Investment Manager is leveraging the PAI indicators, whereby significance thresholds have been defined to identify significantly harmful issuers. Issuers not meeting the significance threshold can be engaged for a limited time period to remediate the adverse impact. Otherwise, if the issuer does not meet the defined significance thresholds twice subsequently or in case of a failed engagement, it does not pass the DNSH assessment. Investments in securities of issuers which do not pass the DNSH assessment are not counted as sustainable investments.

- *How have the indicators for adverse impacts on sustainability factors been taken into account?*

All mandatory PAI indicators are considered either as part of the application of the exclusion criteria or through thresholds on a sectorial or absolute basis. Significance thresholds have been defined and they refer to qualitative or quantitative criteria.

Recognizing the lack of data coverage for some of the PAI indicators equivalent data points are used to assess PAI indicators when applying the DNSH assessment, when relevant, for the following indicators for corporates: share of non-renewable energy consumption and production, activities negatively affecting biodiversity-sensitive areas, emissions to water, lack of processes and compliance mechanisms to monitor compliance with UNGC principles and OECD Guidelines for Multinational Enterprises; for sovereigns: GHG Intensity and investee countries subject to social violations. In case of securities which finance specific projects contributing to environmental or social objectives equivalent data at project level might be used to ensure that Sustainable Investments do not significantly harm any other environmental and/or social objective. The Investment Manager will strive to increase data coverage for PAI indicators with low data coverage by engaging with issuers and data providers. The Investment Manager will regularly evaluate whether the availability of data has increased sufficiently to potentially include assessment of such data in the investment process.

Principal adverse impacts are the most significant negative impacts of investment decisions on sustainability factors relating to environmental, social and employee matters, respect for human rights, anti-corruption and anti-bribery matters.

- *How are the sustainable investments aligned with the OECD Guidelines for Multinational Enterprises and the UN Guiding Principles on Business and Human Rights? Details:*

The Investment Manager's sustainable minimum exclusion list screens out companies based on their involvement in controversial practices against international norms. The core normative framework consists of the Principles of the UN Global Compact, the OECD Guidelines for Multinational Enterprises and the UN Guiding Principles for Business and Human Rights. Securities issued by companies having a severe violation of these frameworks will be restricted from the investment universe.

The EU Taxonomy sets out a "do not significant harm" principle by which Taxonomy-aligned investments should not significantly harm EU Taxonomy objectives and is accompanied by specific EU criteria.

The "do not significant harm" principle applies only to those investments underlying the financial product that take into account the EU criteria for environmentally sustainable economic activities. The investments underlying the remaining portion of this financial product do not take into account the EU criteria for environmentally sustainable economic activities.

Any other sustainable investments must also not significantly harm any environmental or social objectives.



Does this financial product consider principal adverse impacts on sustainability factors?

Yes

No

The Management Company has joined the Net Zero Asset Manager Initiative and considers PAI indicators through stewardship including engagement, both are relevant to mitigate potential adverse impact as a company.

Due to the commitment to the Net Zero Asset Manager Initiative, the Management Company aims to reduce greenhouse gas emissions in partnership with asset owner clients on decarbonisation goals, consistent with an ambition to reach net zero emission by 2050 or sooner across all assets under management. As part of this objective the Management Company will set an interim target for the proportion of assets to be managed in line with the attainment of net zero emissions by 2050 or sooner.

The Sub-Fund's Investment Manager considers PAI indicators regarding greenhouse gas emission, biodiversity, water, waste as well as social and employee matters for corporate issuers, and, where relevant, the freedom house index is applied to investments in sovereigns. PAI indicators are considered within the Investment Manager's investment process through the means of exclusions as described in the "binding elements" section of the Sub-Fund.

The data coverage for the data required for the PAI indicators is heterogenous. The data coverage related to biodiversity, water and waste is low and the related PAI indicators are considered through exclusion of securities issued by companies having a severe violation / breach of principles and guidelines such as the Principles of the United Nations Global Compact, the OECD Guidelines for Multinational Enterprises, and the United Nations Guiding Principles for Business and Human Rights on the grounds of problematic practices around human rights, labour rights, environment, and corruption issues. Therefore, the Investment Manager will strive to increase data coverage for PAI indicators with low data coverage. The Investment Manager will regularly evaluate whether the availability of data has increased sufficiently to potentially include assessment of such data in the investment process.

Additionally, PAI indicators are, among other sustainability factors, applied to derive the SRI Rating. The SRI Rating is used for the portfolio construction.

The following PAI indicators are considered:

Applicable to corporate issuers

- GHG Emissions
- Carbon footprint
- GHG Intensity of investee companies
- Exposure to companies active in the fossil fuel sector
- Activities negatively affecting biodiversity-sensitive areas
- Emissions to water
- Hazardous waste ratio

- Violation of UN Global compact principles
- Lack of processes and compliance mechanisms to monitor compliance with UN Global Compact principles
- Board gender diversity
- Exposure to controversial weapons

Applicable to sovereign and supranational issuers

- Investee countries subject to social violations

The information on the PAI indicators will be available in the end-year report of the Sub-Fund.



What investment strategy does this financial product follow?

The investment strategy guides investment decisions based on factors such as investment objectives and risk tolerance.

Allianz Best Styles Europe Equity SRI's investment objective is to invest in European Equity Markets in accordance with the Sustainable and Responsible Investment Strategy (SRI Strategy). The Investment Manager may engage in foreign currency overlay and thus assume separate foreign currency risks with regard to currencies of OECD member states, even if the Sub-Fund does not include any assets denominated in these respective currencies.

As part of the SRI best-in-class approach, the Sub-Fund takes environmental, social, human rights, governance, and business behaviour factors into account as follows:

- The aforesaid sustainability factors are analysed through SRI Research by the Investment Manager in order to assess how sustainable development and long-term issues are taken into account in the strategy of an issuer. SRI Research means the overall process of identifying potential risks as well as potential opportunities of an investment in securities of an issuer related to the analysis of sustainability factors. SRI Research data combines external research data (which might have some limitations) with internal analyses.
- Based on a combination of the results of the external and/or internal analyses of the sustainability factors, an internal rating is derived monthly (SRI Rating) and is afterwards assigned to a corporate or sovereign issuer.

This internal SRI Rating is used to rank and select or weight securities for the portfolio construction.

The Sub-Fund's general investment approach (Sub-Fund's applicable General Asset Class Principles in combination with its individual investment restrictions) is described in the prospectus.

● What are the binding elements of the investment strategy used to select the investments to attain each of the environmental or social characteristics promoted by this financial product?

The binding elements are:

- Minimum rating coverage: At least 90% of the Sub-Fund's portfolio is required to have an SRI Rating (portfolio in this respect does not comprise non-rated derivatives and instruments that are non-rated by nature e.g., cash and deposits). While most holdings of the Sub-Fund will have a corresponding SRI Rating some investments cannot be rated according to the SRI Research methodology. Examples of instruments not attaining to the SRI Rating include, but are not limited to cash, deposits, Target Funds, and non-rated investments.
- 80% of the rated instruments are adhering to the minimum rating threshold of 1 (out of a rating scale from 0 – 4; 0 being the worst rating and 4 the best rating).
- Reduction of investment universe by excluding at least 20% of issuers.
- Application of the below sustainable minimum exclusion criteria and Sub-Fund specific exclusion criteria.

The following sustainable minimum exclusion criteria for direct investments apply:

- securities issued by companies having a severe violation / breach of principles and guidelines such as the Principles of the United Nations Global Compact, the OECD Guidelines for Multinational Enterprises, and the United Nations Guiding Principles for Business and Human Rights on the grounds of problematic practices around human rights, labour rights, environment, and corruption issues,
- securities issued by companies involved in controversial weapons (anti-personnel mines, cluster munitions, chemical weapons, biological weapons, depleted uranium, white phosphorus, and nuclear weapons),

- securities issued by companies that derive more than 10% of their revenues from weapons, military equipment, and services,
- securities issued by companies that derive more than 10% of their revenue from thermal coal extraction,
- securities issued by utility companies that generate more than 20% of their revenues from coal,
- securities issued by companies involved in the production of tobacco, and securities issued by companies involved in the distribution of tobacco with more than 5% of their revenues.

The following Sub-Fund specific exclusion criteria for direct investments apply:

- Sub-fund assets may not be invested in Equities of issuers which are involved in the production of hydraulic fracturing and/or which provide services in relation to hydraulic fracturing of more than 5% of their revenues
- Sub-fund assets may not be invested in Equities of issuers which are involved in the production of alcohol (limited to spirits) of more than 10% of their revenues
- Sub-fund assets may not be invested in Equities of issuers which are involved in the production of agricultural genetically modified organisms -GMOs- of more than 5% of their revenues
- Sub-fund assets may not be invested in Equities of issuers which are involved in the production of nuclear power and/or which provide services in relation to nuclear power of more than 10% of their revenues
- Sub-fund assets may not be invested in Equities of issuers which are involved in the production of arctic drilling
- Sub-Fund assets may not be invested in Equities of issuers which are involved in the production of gambling and/or which are involved in the distribution/sales of gambling and/or which provide services in relation to gambling of more than 5% of their revenues
- Sub-Fund assets may not be invested in Equities of issuers which are involved in the production and/or exploration of oil sands of more than 5% of their revenues
- Sub-Fund assets may not be invested in Equities of issuers which are involved in the production of military equipment and services and/or which are involved in the distribution/sales of military equipment and services and/or which provide services in relation to military equipment and services of more than 5% of their revenues
- Sub-Fund assets may not be invested in Equities of issuers which are involved in the production of pornography of more than 1% of their revenues and/or which are involved in the distribution/sales of pornography of more than 1% of their revenues

Direct investments in sovereign issuers with an insufficient freedom house index score are excluded.

The sustainable minimum exclusion criteria, as well as the Sub-Fund specific exclusion criteria, are based on information from an external data provider and coded in pre- and post-trade compliance. The review is performed at least half yearly.

● **What is the committed minimum rate to reduce the scope of the investments considered prior to the application of that investment strategy?**

The Sub-Fund commits to reduce the investment universe by at least 20%.

● **What is the policy to assess good governance practices of the investee companies?**

Good governance principles are considered by screening out companies based on their involvement in controversies around international norms corresponding to the four good governance practices: sound management structures, employee relations, remuneration of staff and tax compliance. Companies having a severe violation in either of those areas will not be investible. For certain cases, flagged issuers shall be on a watch list. These companies will appear on this watch list when the Investment Manager believes that engagement may lead to improvements or when the company is assessed to take remedial actions. Companies on the watch list remain investible unless the Investment Manager believes that the engagement or the remedial actions of the company does not lead to the desired remedy of the severe controversy.

In addition, the Sub-Fund's Investment Manager is committed to actively encourage open dialogues with investee companies on corporate governance, proxy voting and broader sustainability issues in advance of shareholder meetings (regularly for direct investments in shares). The Sub-Fund's Investment Manager's

Good governance practices include sound management structures, employee relations, remuneration of staff and tax compliance.

approach to proxy voting and company engagement is set out in the Management Company's Stewardship Statement.



What is the asset allocation planned for this financial product?

Asset allocation describes the share of investments in specific assets.

Min. 90% of the Sub-Funds' assets (excluding cash and non-rated derivatives) are used to meet the environmental or social characteristics promoted by this Sub-Fund. A low portion of the Sub-Fund might contain assets which do not promote environmental or social characteristics. Examples of such instruments are derivatives, cash and deposits, some Target Funds and investment with temporarily divergent or absent environmental, social, or good governance qualifications. Min. 30% of the Sub-Funds' assets will be invested in Sustainable Investments. The minimum percentage of investments that are aligned with the EU Taxonomy is 0.01%. The Sub-Fund's Investment Manager does not commit to a minimum share of environmentally Sustainable Investments that are not aligned with the EU Taxonomy. The Sub-Fund's Investment Manager does not commit to a minimum share of socially sustainable investments. While the Sub-Fund cannot commit to a minimum share of environmentally or socially sustainable investments, such investments may be freely allocated to within the Sub-Fund aggregated sustainable investment commitment disclosed (min. 30%).

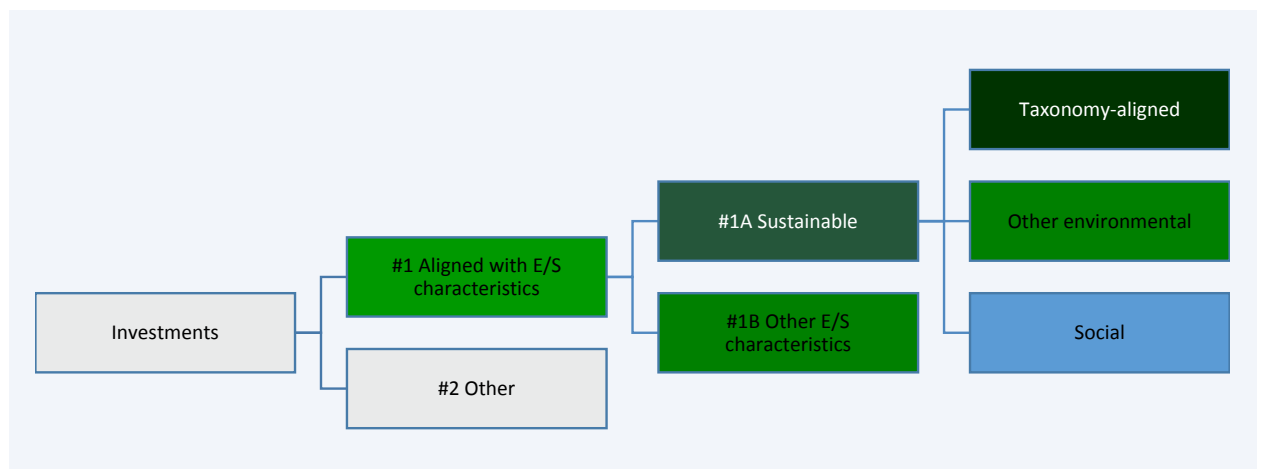

#1 Aligned with E/S characteristics includes the investments of the financial product used to attain the environmental or social characteristics promoted by the financial product.

#2 Other includes the remaining investments of the financial product which are neither aligned with the environmental or social characteristics, nor are qualified as sustainable investments.

The category **#1 Aligned with E/S characteristics** covers:

- The sub-category **#1A Sustainable** covers sustainable investments with environmental or social objectives.
- The sub-category **#1B Other E/S characteristics** covers investments aligned with the environmental or social characteristics that do not qualify as sustainable investments.

● How does the use of derivatives attain the environmental or social characteristics promoted by the financial product?

Not applicable



To what minimum extent are sustainable investments with an environmental objective aligned with the EU Taxonomy?

The Taxonomy-aligned investments include debt and/or equity in environmentally sustainable economic activities aligned with the EU-Taxonomy. The minimum percentage of investments that are aligned with the EU Taxonomy is 0.01%. Taxonomy-aligned data is provided by an external data provider. The Investment Manager has assessed the quality of such data. The data will not be subject to an assurance provided by auditors or a review by third parties. The data will not reflect any data in government bonds. As of today, there is no recognized methodology available to determine the proportion of Taxonomy-aligned activities when investing in government bonds.

Taxonomy-aligned activities in this disclosure are based on share of turnover. Pre-contractual figures use turnover as its financial metric as a default in line with the regulatory requirements and based on the fact that complete, verifiable or up-to date data for CAPEX and/or OPEX as financial metric is even less available.

Taxonomy-aligned data is only in rare cases data reported by companies in accordance with the EU Taxonomy. The data provider has derived Taxonomy-aligned data from other available equivalent public data.

Taxonomy-aligned activities are expressed as a share of:

- **turnover** reflecting the share of revenue from green activities of investee companies
- **capital expenditure** (CapEx) showing the green investments made by investee companies, e.g. for a transition to a green economy.
- **operational expenditure** (OpEx) reflecting green operational activities of investee companies.

● **Does the financial product invest in fossil gas and/or nuclear energy related activities that comply with the EU Taxonomy ¹?**

- Yes:
- In fossil gas
 - In nuclear energy
- No

The Sub-Fund does not pursue any investments in fossil gas and/or nuclear energy related activities that comply with the EU Taxonomy. Nevertheless, as result of this investment strategy, investments may occur in corporates which are also active in these activities. Further information will be provided as part of the annual reporting, if relevant.

The two graphs below show in green the minimum percentage of investments that are aligned with the EU Taxonomy. As there is no appropriate methodology to determine the Taxonomy-alignment of sovereign bonds*, the first graph shows the Taxonomy-alignment in relation to all the investments of the financial product including sovereign bonds, while the second graph shows the Taxonomy-alignment only in relation to the investments of the financial product other than sovereign bonds.

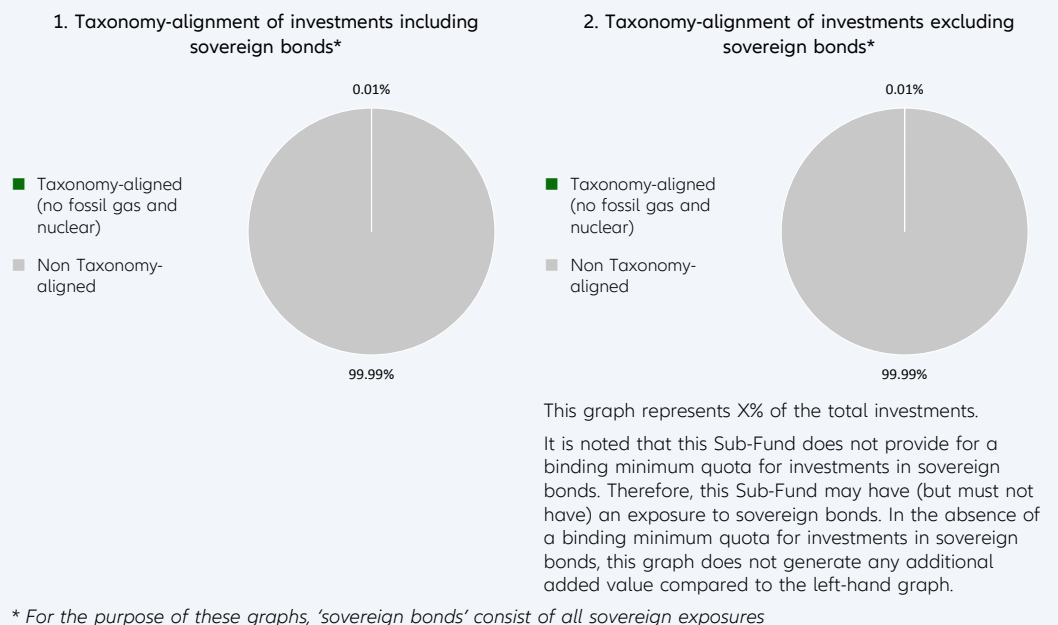

● **What is the minimum share of investments in transitional and enabling activities?**

The Sub-Fund's Investment Manager does not commit to a split of minimum taxonomy alignment into transitional, enabling activities and own performance.

Enabling activities directly enable other activities to make a substantial contribution to an environmental objective.

Transitional activities are activities for which low-carbon alternatives are not yet available and among others have greenhouse gas emission levels corresponding to the best performance.

¹ Fossil gas and/or nuclear related activities will only comply with the EU Taxonomy where they contribute to limiting climate change ("climate change mitigation") and do not significantly harm any EU Taxonomy objective - see explanatory note in the left hand margin. The full criteria for fossil gas and nuclear energy economic activities that comply with the EU Taxonomy are laid down in Commission Delegated Regulation (EU) 2022/1214.



What is the minimum share of sustainable investments with an environmental objective that are not aligned with the EU Taxonomy?

Taxonomy-aligned investments are considered a sub-category of Sustainable Investments. If an investment is not Taxonomy-aligned since the activity is not yet covered under the EU Taxonomy or the positive contribution is not substantial enough to comply with the Taxonomy technical screening criteria, the investment can still be considered an environmentally Sustainable Investment provided it complies with all criteria. The Investment Manager does not commit to a minimum share of environmentally Sustainable Investments that are not aligned with the EU Taxonomy. The overall sustainable investment share may also include investments with an environmental objective in economic activities that do not qualify as environmentally sustainable under the EU Taxonomy, and while the Sub-Fund cannot commit to a minimum share of environmentally or socially sustainable investments, such investments may be freely allocated to within the Sub-Fund aggregated sustainable investment commitment disclosed (min. 30%).



What is the minimum share of socially sustainable investments?

The Investment Manager defines Sustainable Investments based on internal research, which uses, among others, the UN Sustainable Development Goals (SDGs), as well as the objectives of the EU Taxonomy as reference frameworks. The Investment Manager does not commit to a minimum share of socially Sustainable Investments, as the SDGs contain environmental as well as social objectives. The overall sustainable investment share may also include investments with a social objective, and while the Sub-Fund cannot commit to a minimum share of environmentally or socially sustainable investments, such investments may be freely allocated to within the Sub-Fund aggregated sustainable investment commitment disclosed (min. 30%).



What investments are included under “#2 Other”, what is their purpose and are there any minimum environmental or social safeguards?

Under “#2 Other” investments into cash, Target Funds, or derivatives can be included. Derivatives might be used for efficient portfolio management (including risk hedging) and/or investment purposes, and Target Funds to benefit from a specific strategy. For those investments no environmental or social safeguards are applied.



Is a specific index designated as a reference benchmark to determine whether this financial product is aligned with the environmental and/or social characteristics that it promotes?

Yes, the Sub-Fund has assigned MSCI Europe Ext. SRI 5% Issuer Capped Total Return Net as benchmark.

● How is the reference benchmark continuously aligned with each of the environmental or social characteristics promoted by the financial product?

The Sub-Fund uses an SRI benchmark which is however not completely aligned with the environmental or social characteristics promoted by the sub-fund. The benchmark captures large and mid cap stocks across 15 Developed Markets (DM) countries in Europe. The Index is a capitalization weighted index that provides exposure to companies with outstanding Environmental, Social and Governance (ESG) ratings and excludes companies whose products have negative social or environmental impacts.

● How is the alignment of the investment strategy with the methodology of the index ensured on a continuous basis?

The benchmark is not continuously aligned as the screening and exclusion criteria of the benchmark deviate from the Sub-Fund's investment strategy.

● How does the designated index differ from a relevant broad market index?

The benchmark uses ESG criteria as well as exclusion criteria for index construction.



are sustainable investments with an environmental objective that **do not take into account the criteria** for environmentally sustainable economic activities under the EU Taxonomy.

Reference benchmarks are indexes to measure whether the financial product attains the environmental or social characteristics that they promote.

- **Where can the methodology used for the calculation of the designated index be found?**

Details of the Benchmarks' methodology may be found at <https://www.msci.com/documents/10199/aa14b86b-9809-de48-499b-e4a2e9425f33> or at www.msci.com



Where can I find more product specific information online?

More product-specific information can be found on the website: <https://regulatory.allianzgi.com/SFDR>

Template pre-contractual disclosure for the financial products referred to in Article 8, paragraphs 1, 2 and 2a, of Regulation (EU) 2019/2088 and Article 6, first paragraph, of Regulation (EU) 2020/852

Product name:

Allianz Best Styles Global Equity SRI

Legal entity identifier: 5299009P57HYFZWC1553

Environmental and/or social characteristics

Sustainable investment means an investment in an economic activity that contributes to an environmental or social objective, provided that the investment does not significantly harm any environmental or social objective and that the investee companies follow good governance practices.

The **EU Taxonomy** is a classification system laid down in Regulation (EU) 2020/852, establishing a list of **environmentally sustainable economic activities**. That Regulation does not include a list of socially sustainable economic activities. Sustainable investments with an environmental objective might be aligned with the Taxonomy or not.

Does this financial product have a sustainable investment objective?

Yes

No

It will make a minimum of **sustainable investments with an environmental objective**: ____%

in economic activities that qualify as environmentally sustainable under the EU Taxonomy

in economic activities that do not qualify as environmentally sustainable under the EU Taxonomy

It will make a minimum of **sustainable investments with a social objective** ____%

It **promotes Environmental/Social (E/S) characteristics** and while it does not have as its objective a sustainable investment, it will have a minimum proportion of **20.00%** of sustainable investments

with an environmental objective in economic activities that qualify as environmentally sustainable under the EU Taxonomy

with an environmental objective in economic activities that do not qualify as environmentally sustainable under the EU Taxonomy

with a social objective

It promotes E/S characteristics, but **will not make any sustainable investments**



What environmental and/or social characteristics are promoted by this financial product?

Allianz Best Styles Global Equity SRI (the "Sub-Fund") promotes environmental, social, human rights, governance, and business behaviour factors (this domain does not apply for sovereigns issued by a Sovereign Entity) through integration of a best-in-class approach into the Sub-Fund's investment process. This encompasses the evaluation of corporate or sovereign issuers based on an SRI Rating which is used to construct the portfolio.

In addition, sustainable minimum exclusion criteria and Sub-Fund specific exclusion criteria apply.

A reference benchmark has been designated for the purpose of attaining the environmental and/or social characteristics promoted by the Sub-Fund.

● What sustainability indicators are used to measure the attainment of each of the environmental or social characteristics promoted by this financial product?

To measure the attainment of the environmental and/or social characteristics the following sustainability indicators are used and reported on, at the fiscal year end:

- The actual percentage of the Sub-Fund's Portfolio (Portfolio in this respect does not comprise non-rated derivatives and instruments that are non-rated by nature (e. g., cash and deposits)) assets invested in best-in-class issuers (issuers with a minimum SRI Rating of 1 out of a scale from 0-4; 0 being the worst rating and 4 the best rating) is compared to the actual percentage of the benchmarks best-in-class issuers.
- Adherence to a 20% reduction of the investment universe

Sustainability indicators measure how the environmental or social characteristics promoted by the financial product are attained.

- Confirmation that Principal Adverse Impacts (PAIs) of investment decisions on sustainability factors are considered through the application of exclusion criteria.

- **What are the objectives of the sustainable investments that the financial product partially intends to make and how does the sustainable investment contribute to such objectives?**

Sustainable investments contribute to environmental and/or social objectives, for which the Investment Manager uses as reference frameworks, among others, the UN Sustainable Development Goals (SDGs), as well as the objectives of the EU Taxonomy:

1. Climate Change Mitigation
2. Climate Change Adaptation
3. Sustainable Use and Protection of Water and Marine Resources
4. Transition to a Circular Economy
5. Pollution Prevention and Control
6. Protection and Restoration of Biodiversity and Ecosystems

The assessment of the positive contribution to the environmental or social objectives is based on a proprietary framework which combines quantitative elements with qualitative inputs from internal research. The methodology applies first a quantitative breakdown of a securities issuer into its business activities. The qualitative element of the framework is an assessment if business activities contribute positively to an environmental or a social objective.

To calculate the positive contribution on the Sub-Fund level the revenue share of each issuer attributable to business activities contributing to environmental and/or social objectives is considered provided the issuer is satisfying the Do No Significant Harm (“DNSH”) and Good Governance principles, and an asset-weighted aggregation is performed as a second step. Moreover, for certain types of securities, which finance specific projects contributing to environmental or social objectives the overall investment is considered to contribute to environmental and/or social objectives, but also for these a DNSH as well as a Good Governance check for issuers is performed.

- **How do the sustainable investments that the financial product partially intends to make, not cause significant harm to any environmental or social sustainable investment objective?**

In order to ensure that Sustainable Investments do not significantly harm any other environmental and/or social objective, the Investment Manager is leveraging the PAI indicators, whereby significance thresholds have been defined to identify significantly harmful issuers. Issuers not meeting the significance threshold can be engaged for a limited time period to remediate the adverse impact. Otherwise, if the issuer does not meet the defined significance thresholds twice subsequently or in case of a failed engagement, it does not pass the DNSH assessment. Investments in securities of issuers which do not pass the DNSH assessment are not counted as sustainable investments.

- *How have the indicators for adverse impacts on sustainability factors been taken into account?*

All mandatory PAI indicators are considered either as part of the application of the exclusion criteria or through thresholds on a sectorial or absolute basis. Significance thresholds have been defined and they refer to qualitative or quantitative criteria.

Recognizing the lack of data coverage for some of the PAI indicators equivalent data points are used to assess PAI indicators when applying the DNSH assessment, when relevant, for the following indicators for corporates: share of non-renewable energy consumption and production, activities negatively affecting biodiversity-sensitive areas, emissions to water, lack of processes and compliance mechanisms to monitor compliance with UNGC principles and OECD Guidelines for Multinational Enterprises; for sovereigns: GHG Intensity and investee countries subject to social violations. In case of securities which finance specific projects contributing to environmental or social objectives equivalent data at project level might be used to ensure that Sustainable Investments do not significantly harm any other environmental and/or social objective. The Investment Manager will strive to increase data coverage for PAI indicators with low data coverage by engaging with issuers and data providers. The Investment Manager will regularly evaluate whether the availability of data has increased sufficiently to potentially include assessment of such data in the investment process.

Principal adverse impacts are the most significant negative impacts of investment decisions on sustainability factors relating to environmental, social and employee matters, respect for human rights, anti-corruption and anti-bribery matters.

● *How are the sustainable investments aligned with the OECD Guidelines for Multinational Enterprises and the UN Guiding Principles on Business and Human Rights? Details:*

The Investment Manager's sustainable minimum exclusion list screens out companies based on their involvement in controversial practices against international norms. The core normative framework consists of the Principles of the UN Global Compact, the OECD Guidelines for Multinational Enterprises and the UN Guiding Principles for Business and Human Rights. Securities issued by companies having a severe violation of these frameworks will be restricted from the investment universe.

The EU Taxonomy sets out a "do not significant harm" principle by which Taxonomy-aligned investments should not significantly harm EU Taxonomy objectives and is accompanied by specific EU criteria.

The "do not significant harm" principle applies only to those investments underlying the financial product that take into account the EU criteria for environmentally sustainable economic activities. The investments underlying the remaining portion of this financial product do not take into account the EU criteria for environmentally sustainable economic activities.

Any other sustainable investments must also not significantly harm any environmental or social objectives.



Does this financial product consider principal adverse impacts on sustainability factors?

Yes

No

The Management Company has joined the Net Zero Asset Manager Initiative and considers PAI indicators through stewardship including engagement, both are relevant to mitigate potential adverse impact as a company.

Due to the commitment to the Net Zero Asset Manager Initiative, the Management Company aims to reduce greenhouse gas emissions in partnership with asset owner clients on decarbonisation goals, consistent with an ambition to reach net zero emission by 2050 or sooner across all assets under management. As part of this objective the Management Company will set an interim target for the proportion of assets to be managed in line with the attainment of net zero emissions by 2050 or sooner.

The Sub-Fund's Investment Manager considers PAI indicators regarding greenhouse gas emission, biodiversity, water, waste as well as social and employee matters for corporate issuers, and, where relevant, the freedom house index is applied to investments in sovereigns. PAI indicators are considered within the Investment Manager's investment process through the means of exclusions as described in the "binding elements" section of the Sub-Fund.

The data coverage for the data required for the PAI indicators is heterogenous. The data coverage related to biodiversity, water and waste is low and the related PAI indicators are considered through exclusion of securities issued by companies having a severe violation / breach of principles and guidelines such as the Principles of the United Nations Global Compact, the OECD Guidelines for Multinational Enterprises, and the United Nations Guiding Principles for Business and Human Rights on the grounds of problematic practices around human rights, labour rights, environment, and corruption issues. Therefore, the Investment Manager will strive to increase data coverage for PAI indicators with low data coverage. The Investment Manager will regularly evaluate whether the availability of data has increased sufficiently to potentially include assessment of such data in the investment process.

Additionally, PAI indicators are, among other sustainability factors, applied to derive the SRI Rating. The SRI Rating is used for the portfolio construction.

The following PAI indicators are considered:

Applicable to corporate issuers

- GHG Emissions
- Carbon footprint
- GHG Intensity of investee companies
- Exposure to companies active in the fossil fuel sector
- Activities negatively affecting biodiversity-sensitive areas
- Emissions to water
- Hazardous waste ratio

- Violation of UN Global compact principles
- Lack of processes and compliance mechanisms to monitor compliance with UN Global Compact principles
- Board gender diversity
- Exposure to controversial weapons

Applicable to sovereign and supranational issuers

- Investee countries subject to social violations

The information on the PAI indicators will be available in the end-year report of the Sub-Fund.



What investment strategy does this financial product follow?

The investment strategy guides investment decisions based on factors such as investment objectives and risk tolerance.

Allianz Best Styles Global Equity SRI's investment objective is to invest in global Equity Markets in accordance with the Sustainable and Responsible Investment Strategy (SRI Strategy).

As part of the SRI best-in-class approach, the Sub-Fund takes environmental, social, human rights, governance, and business behaviour factors into account as follows:

- The aforesaid sustainability factors are analysed through SRI Research by the Investment Manager in order to assess how sustainable development and long-term issues are taken into account in the strategy of an issuer. SRI Research means the overall process of identifying potential risks as well as potential opportunities of an investment in securities of an issuer related to the analysis of sustainability factors. SRI Research data combines external research data (which might have some limitations) with internal analyses.
- Based on a combination of the results of the external and/or internal analyses of the sustainability factors, an internal rating is derived monthly (SRI Rating) and is afterwards assigned to a corporate or sovereign issuer.

This internal SRI Rating is used to rank and select or weight securities for the portfolio construction.

The Sub-Fund's general investment approach (Sub-Fund's applicable General Asset Class Principles in combination with its individual investment restrictions) is described in the prospectus.

● What are the binding elements of the investment strategy used to select the investments to attain each of the environmental or social characteristics promoted by this financial product?

The binding elements are:

- Minimum rating coverage: At least 90% of the Sub-Fund's portfolio is required to have an SRI Rating (portfolio in this respect does not comprise non-rated derivatives and instruments that are non-rated by nature e.g., cash and deposits). While most holdings of the Sub-Fund will have a corresponding SRI Rating some investments cannot be rated according to the SRI Research methodology. Examples of instruments not attaining to the SRI Rating include, but are not limited to cash, deposits, Target Funds, and non-rated investments.
- 80% of the rated instruments are adhering to the minimum rating threshold of 1 (out of a rating scale from 0 – 4; 0 being the worst rating and 4 the best rating).
- Reduction of investment universe by excluding at least 20% of issuers.
- Application of the below sustainable minimum exclusion criteria and Sub-Fund specific exclusion criteria.

The following sustainable minimum exclusion criteria for direct investments apply:

- securities issued by companies having a severe violation / breach of principles and guidelines such as the Principles of the United Nations Global Compact, the OECD Guidelines for Multinational Enterprises, and the United Nations Guiding Principles for Business and Human Rights on the grounds of problematic practices around human rights, labour rights, environment, and corruption issues,
- securities issued by companies involved in controversial weapons (anti-personnel mines, cluster munitions, chemical weapons, biological weapons, depleted uranium, white phosphorus, and nuclear weapons),
- securities issued by companies that derive more than 10% of their revenues from weapons, military equipment, and services,

- securities issued by companies that derive more than 10% of their revenue from thermal coal extraction,
- securities issued by utility companies that generate more than 20% of their revenues from coal,
- securities issued by companies involved in the production of tobacco, and securities issued by companies involved in the distribution of tobacco with more than 5% of their revenues.

The following Sub-Fund specific exclusion criteria for direct investments apply:

- Sub-fund assets may not be invested in Equities of issuers which are involved in the production of hydraulic fracturing and/or which provide services in relation to hydraulic fracturing of more than 5% of their revenues
- Sub-fund assets may not be invested in Equities of issuers which are involved in the production of alcohol (limited to spirits) of more than 10% of their revenues
- Sub-fund assets may not be invested in Equities of issuers which are involved in the production of agricultural genetically modified organisms -GMOs- of more than 5% of their revenues
- Sub-fund assets may not be invested in Equities of issuers which are involved in the production of nuclear power and/or which provide services in relation to nuclear power of more than 10% of their revenues
- Sub-fund assets may not be invested in Equities of issuers which are involved in the production of arctic drilling
- Sub-Fund assets may not be invested in Equities of issuers which are involved in the production of gambling and/or which are involved in the distribution/sales of gambling and/or which provide services in relation to gambling of more than 5% of their revenues
- Sub-Fund assets may not be invested in Equities of issuers which are involved in the production and/or exploration of oil sands of more than 5% of their revenues
- Sub-Fund assets may not be invested in Equities of issuers which are involved in the production of military equipment and services and/or which are involved in the distribution/sales of military equipment and services and/or which provide services in relation to military equipment and services of more than 5% of their revenues
- Sub-Fund assets may not be invested in Equities of issuers which are involved in the production of pornography of more than 1% of their revenues and/or which are involved in the distribution/sales of pornography of more than 1% of their revenues

Direct investments in sovereign issuers with an insufficient freedom house index score are excluded.

The sustainable minimum exclusion criteria, as well as the Sub-Fund specific exclusion criteria, are based on information from an external data provider and coded in pre- and post-trade compliance. The review is performed at least half yearly.

● **What is the committed minimum rate to reduce the scope of the investments considered prior to the application of that investment strategy?**

The Sub-Fund commits to reduce the investment universe by at least 20%.

● **What is the policy to assess good governance practices of the investee companies?**

Good governance principles are considered by screening out companies based on their involvement in controversies around international norms corresponding to the four good governance practices: sound management structures, employee relations, remuneration of staff and tax compliance. Companies having a severe violation in either of those areas will not be investible. For certain cases, flagged issuers shall be on a watch list. These companies will appear on this watch list when the Investment Manager believes that engagement may lead to improvements or when the company is assessed to take remedial actions. Companies on the watch list remain investible unless the Investment Manager believes that the engagement or the remedial actions of the company does not lead to the desired remedy of the severe controversy.

In addition, the Sub-Fund's Investment Manager is committed to actively encourage open dialogues with investee companies on corporate governance, proxy voting and broader sustainability issues in advance of shareholder meetings (regularly for direct investments in shares). The Sub-Fund's Investment Manager's approach to proxy voting and company engagement is set out in the Management Company's Stewardship Statement.

Good governance practices include sound management structures, employee relations, remuneration of staff and tax compliance.



What is the asset allocation planned for this financial product?

Asset allocation describes the share of investments in specific assets.

Min. 90% of the Sub-Funds' assets (excluding cash and non-rated derivatives) are used to meet the environmental or social characteristics promoted by this Sub-Fund. A low portion of the Sub-Fund might contain assets which do not promote environmental or social characteristics. Examples of such instruments are derivatives, cash and deposits, some Target Funds and investment with temporarily divergent or absent environmental, social, or good governance qualifications. Min. 20% of the Sub-Funds' assets will be invested in Sustainable Investments. The minimum percentage of investments that are aligned with the EU Taxonomy is 0.01%. The Sub-Fund's Investment Manager does not commit to a minimum share of environmentally Sustainable Investments that are not aligned with the EU Taxonomy. The Sub-Fund's Investment Manager does not commit to a minimum share of socially sustainable investments. While the Sub-Fund cannot commit to a minimum share of environmentally or socially sustainable investments, such investments may be freely allocated to within the Sub-Fund aggregated sustainable investment commitment disclosed (min. 20%).

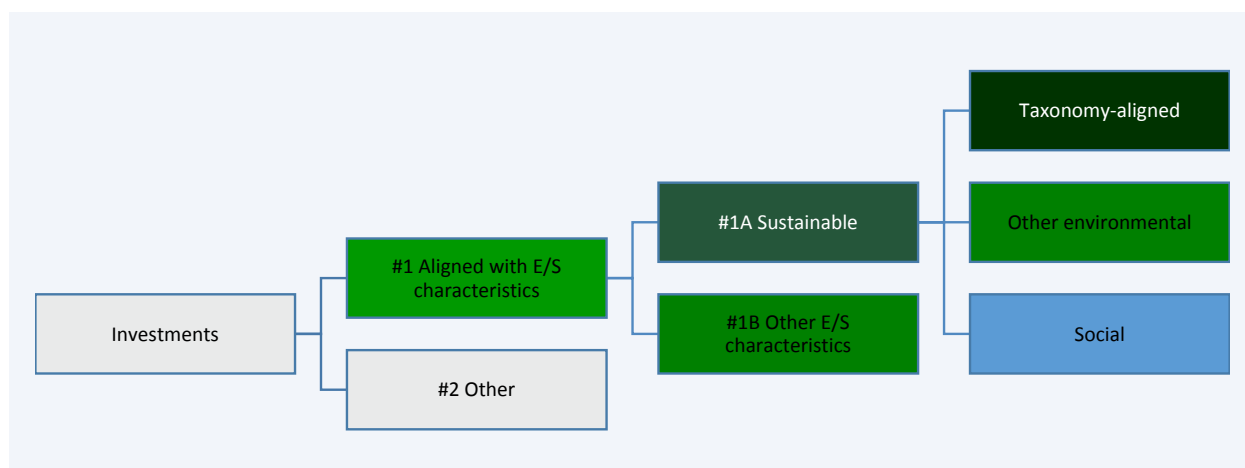

#1 Aligned with E/S characteristics includes the investments of the financial product used to attain the environmental or social characteristics promoted by the financial product.

#2 Other includes the remaining investments of the financial product which are neither aligned with the environmental or social characteristics, nor are qualified as sustainable investments.

The category **#1 Aligned with E/S characteristics** covers:

- The sub-category **#1A Sustainable** covers sustainable investments with environmental or social objectives.
- The sub-category **#1B Other E/S characteristics** covers investments aligned with the environmental or social characteristics that do not qualify as sustainable investments.

● How does the use of derivatives attain the environmental or social characteristics promoted by the financial product?

Not applicable



To what minimum extent are sustainable investments with an environmental objective aligned with the EU Taxonomy?

The Taxonomy-aligned investments include debt and/or equity in environmentally sustainable economic activities aligned with the EU-Taxonomy. The minimum percentage of investments that are aligned with the EU Taxonomy is 0.01%. Taxonomy-aligned data is provided by an external data provider. The Investment Manager has assessed the quality of such data. The data will not be subject to an assurance provided by auditors or a review by third parties. The data will not reflect any data in government bonds. As of today, there is no recognized methodology available to determine the proportion of Taxonomy-aligned activities when investing in government bonds.

Taxonomy-aligned activities in this disclosure are based on share of turnover. Pre-contractual figures use turnover as its financial metric as a default in line with the regulatory requirements and based on the fact that complete, verifiable or up-to date data for CAPEX and/or OPEX as financial metric is even less available.

Taxonomy-aligned data is only in rare cases data reported by companies in accordance with the EU Taxonomy. The data provider has derived Taxonomy-aligned data from other available equivalent public data.

Taxonomy-aligned activities are expressed as a share of:
 - **turnover** reflecting the share of revenue from green activities of investee companies
 - **capital expenditure** (CapEx) showing the green investments made by investee companies, e.g. for a transition to a green economy.
 - **operational expenditure** (OpEx) reflecting green operational activities of investee companies.

● **Does the financial product invest in fossil gas and/or nuclear energy related activities that comply with the EU Taxonomy ¹?**

- Yes:
 In fossil gas In nuclear energy
- No

The Sub-Fund does not pursue any investments in fossil gas and/or nuclear energy related activities that comply with the EU Taxonomy. Nevertheless, as result of this investment strategy, investments may occur in corporates which are also active in these activities. Further information will be provided as part of the annual reporting, if relevant.

The two graphs below show in green the minimum percentage of investments that are aligned with the EU Taxonomy. As there is no appropriate methodology to determine the Taxonomy-alignment of sovereign bonds, the first graph shows the Taxonomy-alignment in relation to all the investments of the financial product including sovereign bonds, while the second graph shows the Taxonomy-alignment only in relation to the investments of the financial product other than sovereign bonds.*

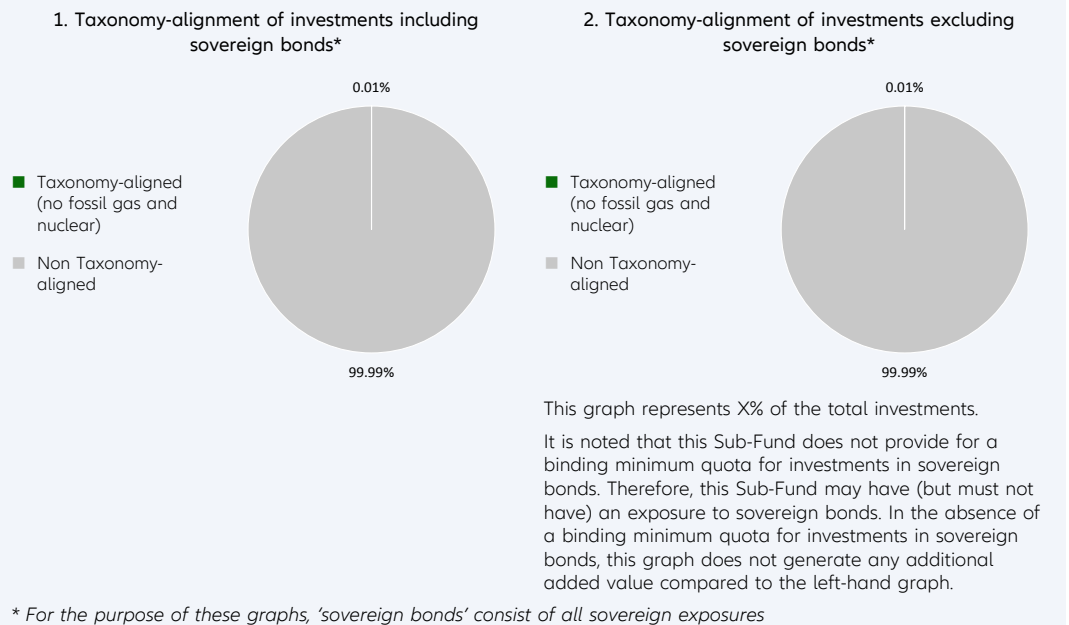

Enabling activities directly enable other activities to make a substantial contribution to an environmental objective.

● **What is the minimum share of investments in transitional and enabling activities?**

The Sub-Fund's Investment Manager does not commit to a split of minimum taxonomy alignment into transitional, enabling activities and own performance.

Transitional activities are activities for which low-carbon alternatives are not yet available and among others have greenhouse gas emission levels corresponding to the best performance.

¹ Fossil gas and/or nuclear related activities will only comply with the EU Taxonomy where they contribute to limiting climate change ("climate change mitigation") and do not significantly harm any EU Taxonomy objective - see explanatory note in the left hand margin. The full criteria for fossil gas and nuclear energy economic activities that comply with the EU Taxonomy are laid down in Commission Delegated Regulation (EU) 2022/1214.



What is the minimum share of sustainable investments with an environmental objective that are not aligned with the EU Taxonomy?

Taxonomy-aligned investments are considered a sub-category of Sustainable Investments. If an investment is not Taxonomy-aligned since the activity is not yet covered under the EU Taxonomy or the positive contribution is not substantial enough to comply with the Taxonomy technical screening criteria, the investment can still be considered an environmentally Sustainable Investment provided it complies with all criteria. The Investment Manager does not commit to a minimum share of environmentally Sustainable Investments that are not aligned with the EU Taxonomy. The overall sustainable investment share may also include investments with an environmental objective in economic activities that do not qualify as environmentally sustainable under the EU Taxonomy, and while the Sub-Fund cannot commit to a minimum share of environmentally or socially sustainable investments, such investments may be freely allocated to within the Sub-Fund aggregated sustainable investment commitment disclosed (min. 20%).



are sustainable investments with an environmental objective that **do not take into account the criteria** for environmentally sustainable economic activities under the EU Taxonomy.



What is the minimum share of socially sustainable investments?

The Investment Manager defines Sustainable Investments based on internal research, which uses, among others, the UN Sustainable Development Goals (SDGs), as well as the objectives of the EU Taxonomy as reference frameworks. The Investment Manager does not commit to a minimum share of socially Sustainable Investments, as the SDGs contain environmental as well as social objectives. The overall sustainable investment share may also include investments with a social objective, and while the Sub-Fund cannot commit to a minimum share of environmentally or socially sustainable investments, such investments may be freely allocated to within the Sub-Fund aggregated sustainable investment commitment disclosed (min. 20%).



What investments are included under “#2 Other”, what is their purpose and are there any minimum environmental or social safeguards?

Under “#2 Other” investments into cash, Target Funds, or derivatives can be included. Derivatives might be used for efficient portfolio management (including risk hedging) and/or investment purposes, and Target Funds to benefit from a specific strategy. For those investments no environmental or social safeguards are applied.



Is a specific index designated as a reference benchmark to determine whether this financial product is aligned with the environmental and/or social characteristics that it promotes?

Yes, the Sub-Fund has assigned MSCI World Ext. SRI 5% Issuer Capped Total Return Net as benchmark.

Reference benchmarks are indexes to measure whether the financial product attains the environmental or social characteristics that they promote.

● How is the reference benchmark continuously aligned with each of the environmental or social characteristics promoted by the financial product?

The Sub-Fund uses an SRI benchmark which is however not completely aligned with the environmental or social characteristics promoted by the sub-fund. The MSCI World SRI 5% Issuer Capped Index captures large and mid cap stocks across 23 Developed Markets (DM) countries. The Index is a capitalization weighted index that provides exposure to companies with outstanding Environmental, Social and Governance (ESG) ratings and excludes companies whose products have negative social or environmental impacts.

● How is the alignment of the investment strategy with the methodology of the index ensured on a continuous basis?

The benchmark is not continuously aligned as the screening and exclusion criteria of the benchmark deviate from the Sub-Fund’s investment strategy.

● How does the designated index differ from a relevant broad market index?

The benchmark uses ESG criteria as well as exclusion criteria for index construction.

- **Where can the methodology used for the calculation of the designated index be found?**

Details of the Benchmarks' methodology may be found at <https://www.msci.com/documents/10199/14191646-df54-4004-8e15-71fc1664436> or at www.msci.com



Where can I find more product specific information online?

More product-specific information can be found on the website: <https://regulatory.allianzgi.com/SFDR>

Template pre-contractual disclosure for the financial products referred to in Article 8, paragraphs 1, 2 and 2a, of Regulation (EU) 2019/2088 and Article 6, first paragraph, of Regulation (EU) 2020/852

Product name:

Allianz Best Styles US Equity

Legal entity identifier: 549300CRWWNBVKIWU63

Environmental and/or social characteristics

Sustainable investment means an investment in an economic activity that contributes to an environmental or social objective, provided that the investment does not significantly harm any environmental or social objective and that the investee companies follow good governance practices.

The EU Taxonomy is a classification system laid down in Regulation (EU) 2020/852, establishing a list of environmentally sustainable economic activities. That Regulation does not include a list of socially sustainable economic activities. Sustainable investments with an environmental objective might be aligned with the Taxonomy or not.

Does this financial product have a sustainable investment objective?	
<input checked="" type="radio"/> <input checked="" type="radio"/> Yes	<input checked="" type="radio"/> <input type="radio"/> No
<input type="checkbox"/> It will make a minimum of sustainable investments with an environmental objective: ___% <ul style="list-style-type: none"> <input type="checkbox"/> in economic activities that qualify as environmentally sustainable under the EU Taxonomy <input type="checkbox"/> in economic activities that do not qualify as environmentally sustainable under the EU Taxonomy 	<input checked="" type="checkbox"/> It promotes Environmental/Social (E/S) characteristics and while it does not have as its objective a sustainable investment, it will have a minimum proportion of 15.00% of sustainable investments <ul style="list-style-type: none"> <input checked="" type="checkbox"/> with an environmental objective in economic activities that qualify as environmentally sustainable under the EU Taxonomy <input checked="" type="checkbox"/> with an environmental objective in economic activities that do not qualify as environmentally sustainable under the EU Taxonomy <input checked="" type="checkbox"/> with a social objective
<input type="checkbox"/> It will make a minimum of sustainable investments with a social objective ___% <ul style="list-style-type: none"> <input type="checkbox"/> It promotes E/S characteristics, but will not make any sustainable investments 	



What environmental and/or social characteristics are promoted by this financial product?

Allianz Best Styles US Equity (the "Sub-Fund") promotes environmental, social, human rights, governance, and business behaviour factors (this domain does not apply for sovereigns issued by a Sovereign Entity) through integration of a best-in-class approach into the Sub-Fund's investment process. This encompasses the evaluation of corporate or sovereign issuers based on an SRI Rating which is used to construct the portfolio.

In addition, sustainable minimum exclusion criteria apply.

No reference benchmark has been designated for the purpose of attaining the environmental and/or social characteristics promoted by the Sub-Fund.

What sustainability indicators are used to measure the attainment of each of the environmental or social characteristics promoted by this financial product?

To measure the attainment of the environmental and/or social characteristics the following sustainability indicators are used and reported on, at the fiscal year end:

- The actual percentage of the Sub-Fund's Portfolio (Portfolio in this respect does not comprise non-rated derivatives and instruments that are non-rated by nature (e. g., cash and deposits)) assets invested in best-in-class issuers (issuers with a minimum SRI Rating of 1 out of a scale from 0-4; 0 being the worst rating and 4 the best rating) is compared to the actual percentage of the benchmarks best-in-class issuers.
- Adherence to a 20% reduction of the investment universe

- Confirmation that Principal Adverse Impacts (PAIs) of investment decisions on sustainability factors are considered through the application of exclusion criteria.

- **What are the objectives of the sustainable investments that the financial product partially intends to make and how does the sustainable investment contribute to such objectives?**

Sustainable investments contribute to environmental and/or social objectives, for which the Investment Manager uses as reference frameworks, among others, the UN Sustainable Development Goals (SDGs), as well as the objectives of the EU Taxonomy:

1. Climate Change Mitigation
2. Climate Change Adaptation
3. Sustainable Use and Protection of Water and Marine Resources
4. Transition to a Circular Economy
5. Pollution Prevention and Control
6. Protection and Restoration of Biodiversity and Ecosystems

The assessment of the positive contribution to the environmental or social objectives is based on a proprietary framework which combines quantitative elements with qualitative inputs from internal research. The methodology applies first a quantitative breakdown of a securities issuer into its business activities. The qualitative element of the framework is an assessment if business activities contribute positively to an environmental or a social objective.

To calculate the positive contribution on the Sub-Fund level the revenue share of each issuer attributable to business activities contributing to environmental and/or social objectives is considered provided the issuer is satisfying the Do No Significant Harm (“DNSH”) and Good Governance principles, and an asset-weighted aggregation is performed as a second step. Moreover, for certain types of securities, which finance specific projects contributing to environmental or social objectives the overall investment is considered to contribute to environmental and/or social objectives, but also for these a DNSH as well as a Good Governance check for issuers is performed.

- **How do the sustainable investments that the financial product partially intends to make, not cause significant harm to any environmental or social sustainable investment objective?**

In order to ensure that Sustainable Investments do not significantly harm any other environmental and/or social objective, the Investment Manager is leveraging the PAI indicators, whereby significance thresholds have been defined to identify significantly harmful issuers. Issuers not meeting the significance threshold can be engaged for a limited time period to remediate the adverse impact. Otherwise, if the issuer does not meet the defined significance thresholds twice subsequently or in case of a failed engagement, it does not pass the DNSH assessment. Investments in securities of issuers which do not pass the DNSH assessment are not counted as sustainable investments.

- *How have the indicators for adverse impacts on sustainability factors been taken into account?*

All mandatory PAI indicators are considered either as part of the application of the exclusion criteria or through thresholds on a sectorial or absolute basis. Significance thresholds have been defined and they refer to qualitative or quantitative criteria.

Recognizing the lack of data coverage for some of the PAI indicators equivalent data points are used to assess PAI indicators when applying the DNSH assessment, when relevant, for the following indicators for corporates: share of non-renewable energy consumption and production, activities negatively affecting biodiversity-sensitive areas, emissions to water, lack of processes and compliance mechanisms to monitor compliance with UNGC principles and OECD Guidelines for Multinational Enterprises; for sovereigns: GHG Intensity and investee countries subject to social violations. In case of securities which finance specific projects contributing to environmental or social objectives equivalent data at project level might be used to ensure that Sustainable Investments do not significantly harm any other environmental and/or social objective. The Investment Manager will strive to increase data coverage for PAI indicators with low data coverage by engaging with issuers and data providers. The Investment Manager will regularly evaluate whether the availability of data has increased sufficiently to potentially include assessment of such data in the investment process.

Principal adverse impacts are the most significant negative impacts of investment decisions on sustainability factors relating to environmental, social and employee matters, respect for human rights, anti-corruption and anti-bribery matters.

- *How are the sustainable investments aligned with the OECD Guidelines for Multinational Enterprises and the UN Guiding Principles on Business and Human Rights? Details:*

The Investment Manager's sustainable minimum exclusion list screens out companies based on their involvement in controversial practices against international norms. The core normative framework consists of the Principles of the UN Global Compact, the OECD Guidelines for Multinational Enterprises and the UN Guiding Principles for Business and Human Rights. Securities issued by companies having a severe violation of these frameworks will be restricted from the investment universe.

The EU Taxonomy sets out a "do not significant harm" principle by which Taxonomy-aligned investments should not significantly harm EU Taxonomy objectives and is accompanied by specific EU criteria.

The "do not significant harm" principle applies only to those investments underlying the financial product that take into account the EU criteria for environmentally sustainable economic activities. The investments underlying the remaining portion of this financial product do not take into account the EU criteria for environmentally sustainable economic activities.

Any other sustainable investments must also not significantly harm any environmental or social objectives.



Does this financial product consider principal adverse impacts on sustainability factors?

Yes

No

The Management Company has joined the Net Zero Asset Manager Initiative and considers PAI indicators through stewardship including engagement, both are relevant to mitigate potential adverse impact as a company.

Due to the commitment to the Net Zero Asset Manager Initiative, the Management Company aims to reduce greenhouse gas emissions in partnership with asset owner clients on decarbonisation goals, consistent with an ambition to reach net zero emission by 2050 or sooner across all assets under management. As part of this objective the Management Company will set an interim target for the proportion of assets to be managed in line with the attainment of net zero emissions by 2050 or sooner.

The Sub-Fund's Investment Manager considers PAI indicators regarding greenhouse gas emission, biodiversity, water, waste as well as social and employee matters for corporate issuers, and, where relevant, the freedom house index is applied to investments in sovereigns. PAI indicators are considered within the Investment Manager's investment process through the means of exclusions as described in the "binding elements" section of the Sub-Fund.

The data coverage for the data required for the PAI indicators is heterogenous. The data coverage related to biodiversity, water and waste is low and the related PAI indicators are considered through exclusion of securities issued by companies having a severe violation / breach of principles and guidelines such as the Principles of the United Nations Global Compact, the OECD Guidelines for Multinational Enterprises, and the United Nations Guiding Principles for Business and Human Rights on the grounds of problematic practices around human rights, labour rights, environment, and corruption issues. Therefore, the Investment Manager will strive to increase data coverage for PAI indicators with low data coverage. The Investment Manager will regularly evaluate whether the availability of data has increased sufficiently to potentially include assessment of such data in the investment process.

Additionally, PAI indicators are, among other sustainability factors, applied to derive the SRI Rating. The SRI Rating is used for the portfolio construction.

The following PAI indicators are considered:

Applicable to corporate issuers

- GHG Emissions
- Carbon footprint
- GHG Intensity of investee companies
- Exposure to companies active in the fossil fuel sector
- Activities negatively affecting biodiversity-sensitive areas
- Emissions to water
- Hazardous waste ratio

- Violation of UN Global compact principles
- Lack of processes and compliance mechanisms to monitor compliance with UN Global Compact principles
- Board gender diversity
- Exposure to controversial weapons

Applicable to sovereign and supranational issuers

- Investee countries subject to social violations

The information on the PAI indicators will be available in the end-year report of the Sub-Fund.



What investment strategy does this financial product follow?

The investment strategy guides investment decisions based on factors such as investment objectives and risk tolerance.

Allianz Best Styles US Equity's investment objective is to invest in US equity markets in accordance with the Sustainable and Responsible Investment Strategy (SRI Strategy). The Investment Manager may engage in foreign currency overlay and thus assume separate foreign currency risks with regard to currencies of OECD member states, even if the Sub-Fund does not include any assets denominated in these respective currencies.

As part of the SRI best-in-class approach, the Sub-Fund takes environmental, social, human rights, governance, and business behaviour factors into account as follows:

- The aforesaid sustainability factors are analysed through SRI Research by the Investment Manager in order to assess how sustainable development and long-term issues are taken into account in the strategy of an issuer. SRI Research means the overall process of identifying potential risks as well as potential opportunities of an investment in securities of an issuer related to the analysis of sustainability factors. SRI Research data combines external research data (which might have some limitations) with internal analyses.
- Based on a combination of the results of the external and/or internal analyses of the sustainability factors, an internal rating is derived monthly (SRI Rating) and is afterwards assigned to a corporate or sovereign issuer.

This internal SRI Rating is used to rank and select or weight securities for the portfolio construction.

The Sub-Fund's general investment approach (Sub-Fund's applicable General Asset Class Principles in combination with its individual investment restrictions) is described in the prospectus.

● What are the binding elements of the investment strategy used to select the investments to attain each of the environmental or social characteristics promoted by this financial product?

The binding elements are:

- Minimum rating coverage: At least 90% of the Sub-Fund's portfolio is required to have an SRI Rating (portfolio in this respect does not comprise non-rated derivatives and instruments that are non-rated by nature e.g., cash and deposits). While most holdings of the Sub-Fund will have a corresponding SRI Rating some investments cannot be rated according to the SRI Research methodology. Examples of instruments not attaining to the SRI Rating include, but are not limited to cash, deposits, Target Funds, and non-rated investments.
- 80% of the rated instruments are adhering to the minimum rating threshold of 1 (out of a rating scale from 0 – 4; 0 being the worst rating and 4 the best rating).
- Reduction of investment universe by excluding at least 20% of issuers.
- Application of the following sustainable minimum exclusion criteria for direct investments:
 - securities issued by companies having a severe violation / breach of principles and guidelines such as the Principles of the United Nations Global Compact, the OECD Guidelines for Multinational Enterprises, and the United Nations Guiding Principles for Business and Human Rights on the grounds of problematic practices around human rights, labour rights, environment, and corruption issues,
 - securities issued by companies involved in controversial weapons (anti-personnel mines, cluster munitions, chemical weapons, biological weapons, depleted uranium, white phosphorus, and nuclear weapons),
 - securities issued by companies that derive more than 10% of their revenues from weapons, military equipment, and services,

- securities issued by companies that derive more than 10% of their revenue from thermal coal extraction,
- securities issued by utility companies that generate more than 20% of their revenues from coal,
- securities issued by companies involved in the production of tobacco, and securities issued by companies involved in the distribution of tobacco with more than 5% of their revenues.

Direct investments in sovereign issuers with an insufficient freedom house index score are excluded.

The sustainable minimum exclusion criteria, as well as the Sub-Fund specific exclusion criteria, are based on information from an external data provider and coded in pre- and post-trade compliance. The review is performed at least half yearly.

● **What is the committed minimum rate to reduce the scope of the investments considered prior to the application of that investment strategy?**

The Sub-Fund commits to reduce the investment universe by at least 20%.

● **What is the policy to assess good governance practices of the investee companies?**

Good governance principles are considered by screening out companies based on their involvement in controversies around international norms corresponding to the four good governance practices: sound management structures, employee relations, remuneration of staff and tax compliance. Companies having a severe violation in either of those areas will not be investible. For certain cases, flagged issuers shall be on a watch list. These companies will appear on this watch list when the Investment Manager believes that engagement may lead to improvements or when the company is assessed to take remedial actions. Companies on the watch list remain investible unless the Investment Manager believes that the engagement or the remedial actions of the company does not lead to the desired remedy of the severe controversy.

In addition, the Sub-Fund's Investment Manager is committed to actively encourage open dialogues with investee companies on corporate governance, proxy voting and broader sustainability issues in advance of shareholder meetings (regularly for direct investments in shares). The Sub-Fund's Investment Manager's approach to proxy voting and company engagement is set out in the Management Company's Stewardship Statement.

Good governance practices include sound management structures, employee relations, remuneration of staff and tax compliance.



What is the asset allocation planned for this financial product?

Asset allocation describes the share of investments in specific assets.

Min. 90% of the Sub-Funds' assets (excluding cash and non-rated derivatives) are used to meet the environmental or social characteristics promoted by this Sub-Fund. A low portion of the Sub-Fund might contain assets which do not promote environmental or social characteristics. Examples of such instruments are derivatives, cash and deposits, some Target Funds and investment with temporarily divergent or absent environmental, social, or good governance qualifications. Min. 15% of the Sub-Funds' assets will be invested in Sustainable Investments. The minimum percentage of investments that are aligned with the EU Taxonomy is 0.01%. The Sub-Fund's Investment Manager does not commit to a minimum share of environmentally Sustainable Investments that are not aligned with the EU Taxonomy. The Sub-Fund's Investment Manager does not commit to a minimum share of socially sustainable investments. While the Sub-Fund cannot commit to a minimum share of environmentally or socially sustainable investments, such investments may be freely allocated to within the Sub-Fund aggregated sustainable investment commitment disclosed (min. 15%).

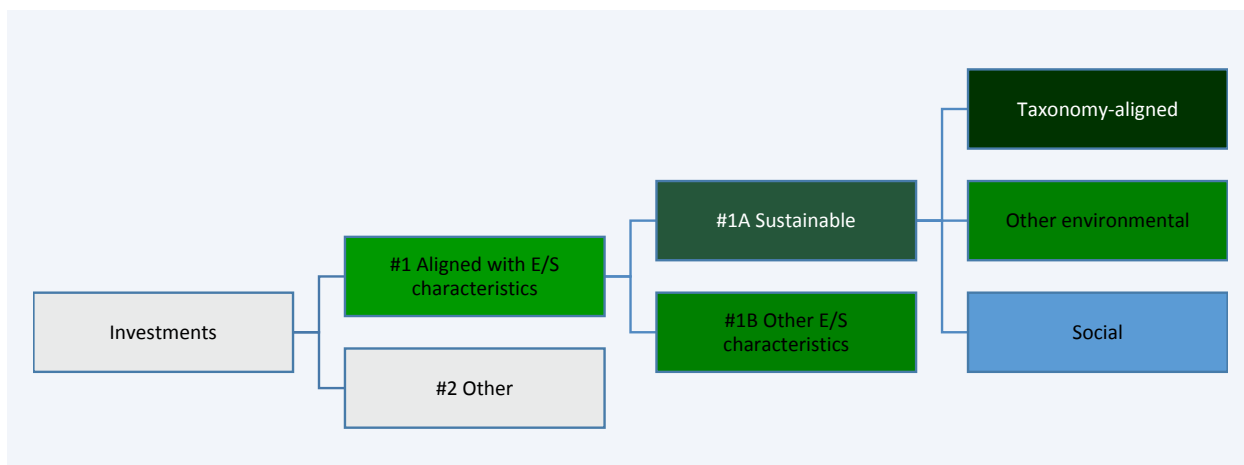

#1 Aligned with E/S characteristics includes the investments of the financial product used to attain the environmental or social characteristics promoted by the financial product.

#2 Other includes the remaining investments of the financial product which are neither aligned with the environmental or social characteristics, nor are qualified as sustainable investments.

The category **#1 Aligned with E/S characteristics** covers:

- The sub-category **#1A Sustainable** covers sustainable investments with environmental or social objectives.
- The sub-category **#1B Other E/S characteristics** covers investments aligned with the environmental or social characteristics that do not qualify as sustainable investments.

- **How does the use of derivatives attain the environmental or social characteristics promoted by the financial product?**

Not applicable



To what minimum extent are sustainable investments with an environmental objective aligned with the EU Taxonomy?

The Taxonomy-aligned investments include debt and/or equity in environmentally sustainable economic activities aligned with the EU-Taxonomy. The minimum percentage of investments that are aligned with the EU Taxonomy is 0.01%. Taxonomy-aligned data is provided by an external data provider. The Investment Manager has assessed the quality of such data. The data will not be subject to an assurance provided by auditors or a review by third parties. The data will not reflect any data in government bonds. As of today, there is no recognized methodology available to determine the proportion of Taxonomy-aligned activities when investing in government bonds.

Taxonomy-aligned activities in this disclosure are based on share of turnover. Pre-contractual figures use turnover as its financial metric as a default in line with the regulatory requirements and based on the fact that complete, verifiable or up-to date data for CAPEX and/or OPEX as financial metric is even less available.

Taxonomy-aligned data is only in rare cases data reported by companies in accordance with the EU Taxonomy. The data provider has derived Taxonomy-aligned data from other available equivalent public data.

- **Does the financial product invest in fossil gas and/or nuclear energy related activities that comply with the EU Taxonomy ¹?**

Yes:

In fossil gas In nuclear energy

No

The Sub-Fund does not pursue any investments in fossil gas and/or nuclear energy related activities that comply with the EU Taxonomy. Nevertheless, as result of this investment strategy, investments may occur in corporates which are also active in these activities. Further information will be provided as part of the annual reporting, if relevant.

Taxonomy-aligned activities are expressed as a share of:

- **turnover** reflecting the share of revenue from green activities of investee companies
- **capital expenditure (CapEx)** showing the green investments made by investee companies, e.g. for a transition to a green

¹ Fossil gas and/or nuclear related activities will only comply with the EU Taxonomy where they contribute to limiting climate change ("climate change mitigation") and do not significantly harm any EU Taxonomy objective - see explanatory note in the left hand margin. The full criteria for fossil gas and nuclear energy economic activities that comply with the EU Taxonomy are laid down in Commission Delegated Regulation (EU) 2022/1214.

economy.
 - **operational expenditure** (OpEx) reflecting green operational activities of investee companies.

The two graphs below show in green the minimum percentage of investments that are aligned with the EU Taxonomy. As there is no appropriate methodology to determine the Taxonomy-alignment of sovereign bonds*, the first graph shows the Taxonomy-alignment in relation to all the investments of the financial product including sovereign bonds, while the second graph shows the Taxonomy-alignment only in relation to the investments of the financial product other than sovereign bonds.

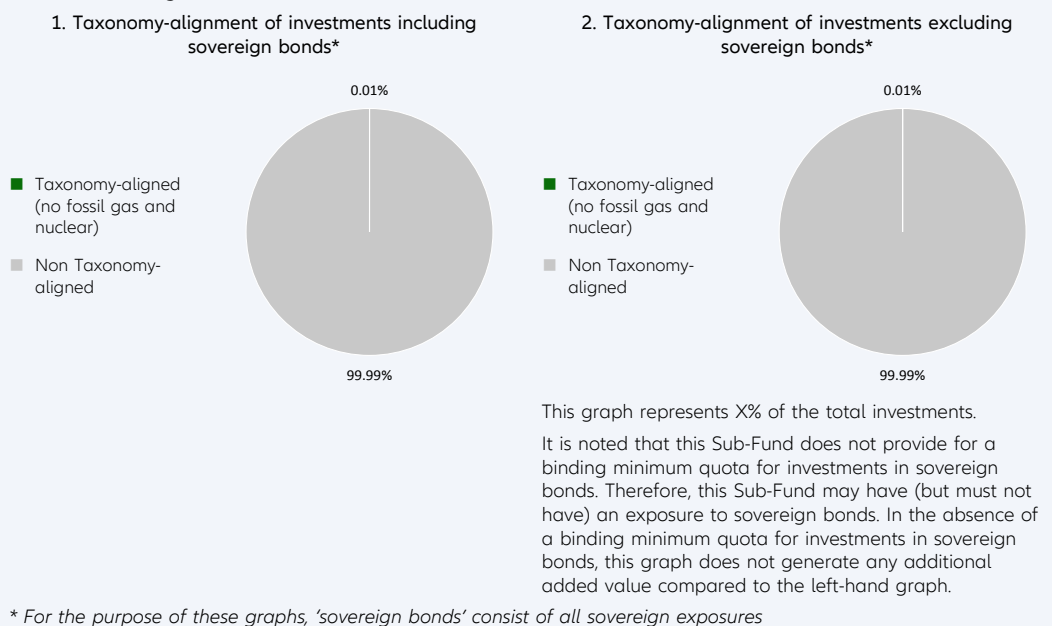

Enabling activities directly enable other activities to make a substantial contribution to an environmental objective.

Transitional activities are activities for which low-carbon alternatives are not yet available and among others have greenhouse gas emission levels corresponding to the best performance.

● **What is the minimum share of investments in transitional and enabling activities?**

The Sub-Fund's Investment Manager does not commit to a split of minimum taxonomy alignment into transitional, enabling activities and own performance.



What is the minimum share of sustainable investments with an environmental objective that are not aligned with the EU Taxonomy?

Taxonomy-aligned investments are considered a sub-category of Sustainable Investments. If an investment is not Taxonomy-aligned since the activity is not yet covered under the EU Taxonomy or the positive contribution is not substantial enough to comply with the Taxonomy technical screening criteria, the investment can still be considered an environmentally Sustainable Investment provided it complies with all criteria. The Investment Manager does not commit to a minimum share of environmentally Sustainable Investments that are not aligned with the EU Taxonomy. The overall sustainable investment share may also include investments with an environmental objective in economic activities that do not qualify as environmentally sustainable under the EU Taxonomy, and while the Sub-Fund cannot commit to a minimum share of environmentally or socially sustainable investments, such investments may be freely allocated to within the Sub-Fund aggregated sustainable investment commitment disclosed (min. 15%).

are sustainable investments with an environmental objective that **do not take into account the criteria** for environmentally sustainable economic activities under the EU Taxonomy.



What is the minimum share of socially sustainable investments?

The Investment Manager defines Sustainable Investments based on internal research, which uses, among others, the UN Sustainable Development Goals (SDGs), as well as the objectives of the EU Taxonomy as reference frameworks. The Investment Manager does not commit to a minimum share of socially Sustainable Investments, as the SDGs contain environmental as well as social objectives. The overall sustainable investment share may also include investments with a social objective, and while the Sub-Fund cannot commit to a minimum share of environmentally or socially sustainable investments, such investments may be freely allocated to within the Sub-Fund aggregated sustainable investment commitment disclosed (min. 15%).



What investments are included under “#2 Other”, what is their purpose and are there any minimum environmental or social safeguards?

Under “#2 Other” investments into cash, Target Funds, or derivatives can be included. Derivatives might be used for efficient portfolio management (including risk hedging) and/or investment purposes, and Target Funds to benefit from a specific strategy. For those investments no environmental or social safeguards are applied.



Is a specific index designated as a reference benchmark to determine whether this financial product is aligned with the environmental and/or social characteristics that it promotes?

No reference benchmark has been designated for the purpose of attaining the environmental and/or social characteristics promoted by the Sub-Fund.

Reference benchmarks are indexes to measure whether the financial product attains the environmental or social characteristics that they promote.

- **How is the reference benchmark continuously aligned with each of the environmental or social characteristics promoted by the financial product?**
Not applicable
- **How is the alignment of the investment strategy with the methodology of the index ensured on a continuous basis?**
Not applicable
- **How does the designated index differ from a relevant broad market index?**
Not applicable
- **Where can the methodology used for the calculation of the designated index be found?**
Not applicable



Where can I find more product specific information online?

More product-specific information can be found on the website: <https://regulatory.allianzgi.com/SFDR>

Template pre-contractual disclosure for the financial products referred to in Article 9, paragraphs 1 to 4a, of Regulation (EU) 2019/2088 and Article 5, first paragraph, of Regulation (EU) 2020/852

Product name:

Allianz Better World Defensive

Legal entity identifier: 529900ASTWITUJ82W129

Sustainable investment objective

Sustainable investment means an investment in an economic activity that contributes to an environmental or social objective, provided that the investment does not significantly harm any environmental or social objective and that the investee companies follow good governance practices.

The EU Taxonomy is a classification system laid down in Regulation (EU) 2020/852, establishing a list of **environmentally sustainable economic activities**. That Regulation does not include a list of socially sustainable economic activities. Sustainable investments with an environmental objective might be aligned with the Taxonomy or not.

Does this financial product have a sustainable investment objective?	
<input checked="" type="radio"/> <input checked="" type="radio"/> <input checked="" type="checkbox"/> Yes	<input type="radio"/> <input type="radio"/> <input type="checkbox"/> No
<input checked="" type="checkbox"/> It will make a minimum of sustainable investments with an environmental objective: 30.00%	<input type="checkbox"/> It promotes Environmental/Social (E/S) characteristics and while it does not have as its objective a sustainable investment, it will have a minimum proportion of ___% of sustainable investments
<input checked="" type="checkbox"/> in economic activities that qualify as environmentally sustainable under the EU Taxonomy	<input type="checkbox"/> with an environmental objective in economic activities that qualify as environmentally sustainable under the EU Taxonomy
<input checked="" type="checkbox"/> in economic activities that do not qualify as environmentally sustainable under the EU Taxonomy	<input type="checkbox"/> with an environmental objective in economic activities that do not qualify as environmentally sustainable under the EU Taxonomy
<input checked="" type="checkbox"/> It will make a minimum of sustainable investments with a social objective 7.00%	<input type="checkbox"/> with a social objective
	<input type="checkbox"/> It promotes E/S characteristics, but will not make any sustainable investments

The Sub-Fund will invest more than 80% of its assets in Sustainable Investments and this commitment is achieved through environmentally or socially sustainable investments.



What is the sustainable investment objective of this financial product?

Allianz Better World Defensive's (the "Sub-Fund") invests in securities of companies providing products or services which contribute to environmental or social objectives, as defined by the UN Sustainable Development Goals (SDGs) or the EU Taxonomy objectives, which are also related to the SDGs. The contribution is measured according to the Sustainable Investment methodology.

In addition, sustainable minimum exclusion criteria apply.

No reference benchmark has been designated for the purpose of meeting the sustainable investment objective.

● What sustainability indicators are used to measure the attainment of the sustainable investment objective of this financial product?

To measure the attainment of the Sub-Fund's sustainable investment objective the following sustainability indicators are used and reported on, at the fiscal year end:

- The actual Sustainable Investment share – which is based on SDGs or EU Taxonomy objectives
- Principle Adverse Impacts (PAIs) of investment decisions on sustainability factors are considered through the application of exclusion criteria.

The Sustainable Investment share is based on the following methodology: Sustainable investments contribute to environmental and/or social objectives, for which the Investment Managers uses as reference

Sustainability indicators measure how the sustainable objectives of this financial product are attained.

frameworks, among others, the UN Sustainable Development Goals (SDGs), as well as the objectives of the EU Taxonomy:

1. Climate Change Mitigation
2. Climate Change Adaptation
3. Sustainable Use and Protection of Water and Marine Resources
4. Transition to a Circular Economy
5. Pollution Prevention and Control
6. Protection and Restoration of Biodiversity and Ecosystems

The assessment of the positive contribution to the environmental or social objectives is based on a proprietary framework which combines quantitative elements with qualitative inputs from internal research. The methodology applies first a quantitative breakdown of a securities issuer into its business activities. The qualitative element of the framework is an assessment if business activities contribute positively to an environmental or a social objective. To calculate the positive contribution on the Sub-Fund level the revenue share of each issuer attributable to business activities contributing to environmental and/or social objectives is considered provided the issuer is satisfying the Do No Significant Harm (“DNSH”) and Good Governance principles, and an asset-weighted aggregation is performed as a second step. Moreover, for certain types of securities, which finance specific projects contributing to environmental or social objectives the overall investment is considered to contribute to environmental and/or social objectives, but also for these a DNSH as well as a Good Governance check for issuers is performed.

● **How do sustainable investments not cause significant harm to any environmental or social sustainable investment objective?**

In order to ensure that Sustainable Investments do not significantly harm any other environmental and/or social objective, the Investment Manager is leveraging the PAI indicators, whereby significance thresholds have been defined to identify significantly harmful issuers. Issuers not meeting the significance threshold can be engaged for a limited time period to remediate the adverse impact. Otherwise, if the issuer does not meet the defined significance thresholds twice subsequently or in case of a failed engagement, it does not pass the DNSH assessment. Investments in securities of issuers which do not pass the DNSH assessment are not counted as sustainable investments.

● *How have the indicators for adverse impacts on sustainability factors been taken into account?*

All mandatory PAI indicators are considered either as part of the application of the exclusion criteria or through thresholds on a sectorial or absolute basis. Significance thresholds have been defined and they refer to qualitative or quantitative criteria.

Recognizing the lack of data coverage for some of the PAI indicators equivalent data points are used to assess PAI indicators when applying the DNSH assessment, when relevant, for the following indicators for corporates: share of non-renewable energy consumption and production, activities negatively affecting biodiversity-sensitive areas, emissions to water, lack of processes and compliance mechanisms to monitor compliance with UNGC principles and OECD Guidelines for Multinational Enterprises; for sovereigns: GHG Intensity and investee countries subject to social violations. In case of securities which finance specific projects contributing to environmental or social objectives equivalent data at project level might be used to ensure that Sustainable Investments do not significantly harm any other environmental and/or social objective. The Investment Manager will strive to increase data coverage for PAI indicators with low data coverage by engaging with issuers and data providers. The Investment Manager will regularly evaluate whether the availability of data has increased sufficiently to potentially include assessment of such data in the investment process.

● *How are the sustainable investments aligned with the OECD Guidelines for Multinational Enterprises and the UN Guiding Principles on Business and Human Rights? Details:*

The Investment Manager’s sustainable minimum exclusion list screens out companies based on their involvement in controversial practices against international norms. The core normative framework consists of the Principles of the UN Global Compact, the OECD Guidelines for Multinational Enterprises and the UN Guiding Principles for Business and Human Rights. Securities issued by companies having a severe violation of these frameworks will be restricted from the investment universe.

Principal adverse impacts are the most significant negative impacts of investment decisions on sustainability factors relating to environmental, social and employee matters, respect for human rights, anti-corruption and anti-bribery matters.



Does this financial product consider principal adverse impacts on sustainability factors?

Yes

No

The Management Company has joined the Net Zero Asset Manager Initiative and considers PAI indicators through stewardship including engagement, both are relevant to mitigate potential adverse impact as a company.

Due to the commitment to the Net Zero Asset Manager Initiative, the Management Company aims to reduce greenhouse gas emissions in partnership with asset owner clients on decarbonisation goals, consistent with an ambition to reach net zero emission by 2050 or sooner across all assets under management. As part of this objective the Management Company will set an interim target for the proportion of assets to be managed in line with the attainment of net zero emissions by 2050 or sooner.

The Sub-Fund's Investment Manager considers PAI indicators regarding greenhouse gas emission, biodiversity, water, waste as well as social and employee matters for corporate issuers, and, where relevant, the freedom house index is applied to investments in sovereigns. PAI indicators are considered within the Investment Manager's investment process through the means of exclusions as described in the "sustainable investment objective" section of the Sub-Fund.

The data coverage for the data required for the PAI indicators is heterogenous. The data coverage related to biodiversity, water and waste is low and the related PAI indicators are considered through exclusion of securities issued by companies having a severe violation / breach of principles and guidelines such as the Principles of the United Nations Global Compact, the OECD Guidelines for Multinational Enterprises, and the United Nations Guiding Principles for Business and Human Rights on the grounds of problematic practices around human rights, labour rights, environment, and corruption issues. Therefore, the Investment Manager will strive to increase data coverage for PAI indicators with low data coverage. The Investment Manager will regularly evaluate whether the availability of data has increased sufficiently to potentially include assessment of such data in the investment process.

Additionally, PAI indicators are considered as part of the requirement of the Sub-Fund to invest more than 80% into Sustainable Investments. PAI indicators are used as part of the DNSH assessment. Investments in securities of issuers who do not pass the DNSH assessment are not counted as sustainable investments.

The following PAI indicators are considered:

Applicable to corporate issuers

- GHG Emissions
- Carbon footprint
- GHG Intensity of investee companies
- Exposure to companies active in the fossil fuel sector
- Share of non-renewable energy consumption and production
- Energy consumption intensity per high impact climate sector
- Activities negatively affecting biodiversity-sensitive areas
- Emissions to water
- Hazardous waste ratio
- Violation of UN Global compact principles
- Lack of processes and compliance mechanisms to monitor compliance with UN Global Compact principles
- Unadjusted gender pay gap
- Board gender diversity
- Exposure to controversial weapons

Applicable to sovereign and supranational issuers

- GHG Intensity
- Investee countries subject to social violations

The information on the PAI indicators will be available in the end-year report of the Sub-Fund.



What investment strategy does this financial product follow?

The investment strategy guides investment decisions based on factors such as investment objectives and risk tolerance.

Allianz Better World Defensive's investment objective is to invest in global Equity and Bond Markets with a focus on companies with an engagement in one or more United Nations' SDGs and/ or on companies supporting climate-related or social projects, and hence create positive outcomes for environment and society in accordance with the SDG-Aligned Strategy Type A. The Sub-Fund invests in Equities and Debt Securities of companies which offer products and services across themes. Examples of such themes and topics include, but are not limited to, affordable healthcare, education, energy transition, food security, financial inclusion, water, and waste management as targeted by the SDGs, as well as in Green Bonds, Social Bonds, Sustainable Bonds and Sustainability-Linked bonds.

The assessment of the contribution to the specified SDGs is based in particular on qualitative and quantitative analysis using internal sensitivity scores and revenue attribution as sustainability indicators.

In case of certain Debt Securities which have been issued to support specific environmental, social, or sustainable projects, the respective bond proceeds and/or selection of defined SDGs-related Key Performance Indicators (KPIs) indicated in the respective applicable Green Bond Principles/ Social Bond Principles/ Sustainability-Linked Bond Principles – instead of the revenue of the respective Debt Security's issuer – are accounted for in the assessment of the contribution to the SDGs.

The Sub-Fund's general investment approach (Sub-Fund's applicable General Asset Class Principles in combination with its individual investment restrictions) is described in the prospectus.

● What are the binding elements of the investment strategy used to select the investments to attain the sustainable investment objective?

The binding elements are:

- Minimum 80% of the Sub-Fund assets' weighted average shall result from revenue generated from issuers' activities that facilitate the achievement of one or more SDG or EU Taxonomy objectives as measured according to the Sustainable Investment methodology.
- For at least 80% of Sub-Fund portfolio, the respective issuer shall have a minimum share of 20% Sustainable Investments, for the remaining 20% (or less) of the Sub-Fund portfolio, each respective issuer shall have a minimum share of at least 5% Sustainable Investment. Cash and derivatives are excluded from these thresholds.

If the Investment Manager acquires a use of proceed security, which finance specific projects contributing to environmental or social objectives, the overall investment is considered to contribute to environmental and/or social objectives according to the Sustainable Investment methodology.

- Application of the following sustainable minimum exclusion criteria for direct investments:
 - securities issued by companies having a severe violation / breach of principles and guidelines such as the Principles of the United Nations Global Compact, the OECD Guidelines for Multinational Enterprises, and the United Nations Guiding Principles for Business and Human Rights on the grounds of problematic practices around human rights, labour rights, environment, and corruption issues,
 - securities issued by companies involved in controversial weapons (anti-personnel mines, cluster munitions, chemical weapons, biological weapons, depleted uranium, white phosphorus, and nuclear weapons),
 - securities issued by companies that derive more than 10% of their revenues from weapons, military equipment, and services,
 - securities issued by companies that derive more than 10% of their revenue from thermal coal extraction,
 - securities issued by utility companies that generate more than 20% of their revenues from coal,
 - securities issued by companies involved in the production of tobacco, and securities issued by companies involved in the distribution of tobacco more with than 5% of their revenues.

Direct investments in sovereign issuers with an insufficient freedom house index score are excluded.

The sustainable minimum exclusion criteria are based on information from an external data provider and coded in pre- and post-trade compliance. The review is performed at least half yearly.

Good governance practices include sound management structures, employee relations, remuneration of staff and tax compliance.

● **What is the policy to assess good governance practices of the investee companies?**

Good governance principles are considered by screening out companies based on their involvement in controversies around international norms corresponding to the four good governance practices: sound management structures, employee relations, remuneration of staff and tax compliance. Companies having a severe violation in either of those areas will not be investible. For certain cases, flagged issuers shall be on a watch list. These companies will appear on this watch list when the Investment Manager believes that engagement may lead to improvements or when the company is assessed to take remedial actions. Companies on the watch list remain investible unless the Investment Manager believes that the engagement or the remedial actions of the company does not lead to the desired remedy of the severe controversy.

In addition, the Sub-Fund’s Investment Manager is committed to actively encourage open dialogues with investee companies on corporate governance, proxy voting and broader sustainability issues in advance of shareholder meetings (regularly for direct investments in shares). The Sub-Fund’s Investment Manager’s approach to proxy voting and company engagement is set out in the Management Company’s Stewardship Statement.



Asset allocation describes the share of investments in specific assets.

What is the asset allocation and the minimum share of sustainable investments?

The Sub-Fund invest primarily into securities which offer products and services to facilitate the achievements of the SDGs. The Sub-Fund will invest more than 80% into Sustainable Investments.

The minimum percentage of investments that are aligned with environmental objective is 30%. The minimum percentage of investments that are aligned with the EU Taxonomy is 0.01%. The minimum percentage of investments that are aligned with social objective is 7%.



● **How does the use of derivatives attain the sustainable investment objective?**

Not applicable



To what minimum extent are sustainable investments with an environmental objective aligned with the EU Taxonomy?

The Taxonomy-aligned investments include debt and/or equity in environmentally sustainable economic activities aligned with the EU-Taxonomy. The minimum percentage of investments that are aligned with the EU Taxonomy is 0.01%. Taxonomy-aligned data is provided by an external data provider. The Investment Manager has assessed the quality of such data. The data will not be subject to an assurance provided by auditors or a review by third parties. The data will not reflect any data in government bonds. As of today, there is no recognized methodology available to determine the proportion of Taxonomy-aligned activities when investing in government bonds.

Taxonomy-aligned activities in this disclosure are based on share of turnover. Pre-contractual figures use turnover as its financial metric as a default in line with the regulatory requirements and based on the fact that complete, verifiable or up-to date data for CAPEX and/or OPEX as financial metric is even less available.

Taxonomy-aligned data is only in rare cases data reported by companies in accordance with the EU Taxonomy. The data provider has derived Taxonomy-aligned data from other available equivalent public data.

Taxonomy-aligned activities are expressed as a share of:
 - **turnover** reflecting the share of revenue from green activities of investee companies
 - **capital expenditure** (CapEx) showing the green investments made by investee companies, e.g. for a transition to a green economy.
 - **operational expenditure** (OpEx) reflecting green operational activities of investee companies.

● **Does the financial product invest in fossil gas and/or nuclear energy related activities that comply with the EU Taxonomy ¹?**

- Yes:
 - In fossil gas
 - In nuclear energy
- No

The Sub-Fund does not pursue any investments in fossil gas and/or nuclear energy related activities that comply with the EU Taxonomy. Nevertheless, as result of this investment strategy, investments may occur in corporates which are also active in these activities. Further information will be provided as part of the annual reporting, if relevant.

The two graphs below show in green the minimum percentage of investments that are aligned with the EU Taxonomy. As there is no appropriate methodology to determine the Taxonomy-alignment of sovereign bonds, the first graph shows the Taxonomy-alignment in relation to all the investments of the financial product including sovereign bonds, while the second graph shows the Taxonomy-alignment only in relation to the investments of the financial product other than sovereign bonds.*

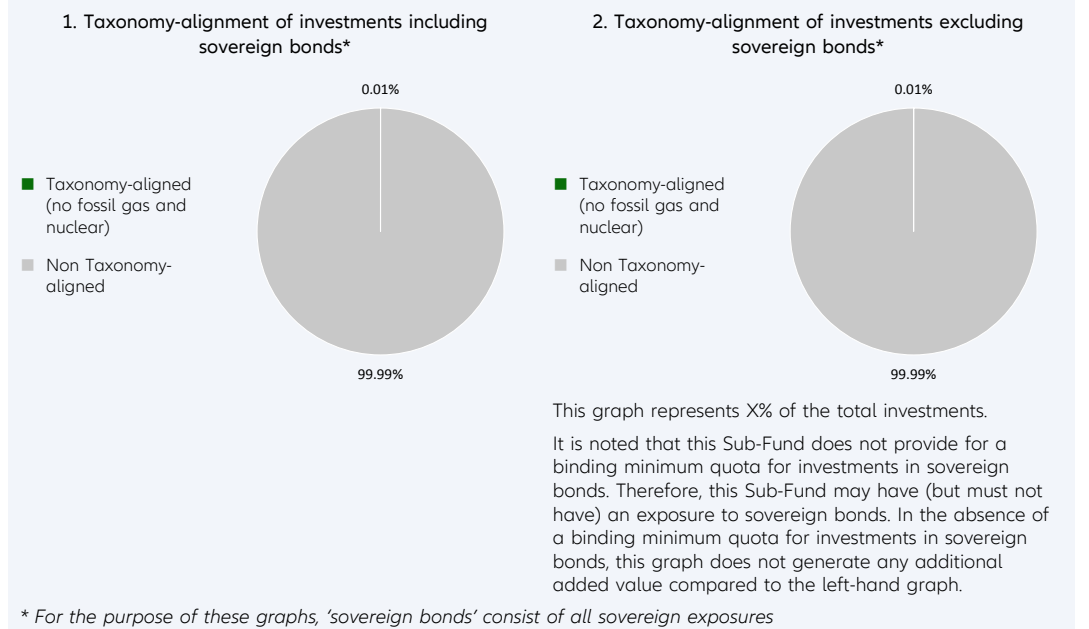

Enabling activities directly enable other activities to make a substantial contribution to an environmental objective.

Transitional activities are activities for which low-carbon alternatives are not yet available and among others have greenhouse gas emission levels corresponding to the best performance.

● **What is the minimum share of investments in transitional and enabling activities?**

The Sub-Fund's Investment Manager does not commit to a split of minimum taxonomy alignment into transitional, enabling activities and own performance.

¹ Fossil gas and/or nuclear related activities will only comply with the EU Taxonomy where they contribute to limiting climate change ("climate change mitigation") and do not significantly harm any EU Taxonomy objective - see explanatory note in the left hand margin. The full criteria for fossil gas and nuclear energy economic activities that comply with the EU Taxonomy are laid down in Commission Delegated Regulation (EU) 2022/1214.



What is the minimum share of sustainable investments with an environmental objective that are not aligned with the EU Taxonomy?

Taxonomy-aligned investments are considered a sub-category of Sustainable Investments. If an investment is not Taxonomy-aligned since the activity is not yet covered under the EU Taxonomy or the positive contribution is not substantial enough to comply with the Taxonomy technical screening criteria, the investment can still be considered an environmentally Sustainable Investment provided it complies with all criteria. The total share of environmentally Sustainable Investments including EU Taxonomy of the Sub-Fund is at least 30%. The overall sustainable investment share may also include investments with an environmental objective in economic activities that do not qualify as environmentally sustainable under the EU Taxonomy. Combined with socially Sustainable Investment the Sub-Fund will invest more than 80% of its assets in Sustainable Investments.

are environmentally sustainable investments that do not take into account the criteria for environmentally sustainable economic activities under the EU Taxonomy.



What is the minimum share of sustainable investments with a social objective?

The Sub-Fund’s investment manager commits to a minimum share of socially Sustainable Investment of 7%. Combined with environmentally Sustainable Investment the Sub-Fund will invest more than 80% of its assets in Sustainable Investments



What investments are included under “#2 Not sustainable”, what is their purpose and are there any minimum environmental or social safeguards?

Under “#2 Not sustainable” parts of investments are included related to business activities which are not counted as Sustainable Investments. In addition, the Investment Manager might invest into cash, Targets Funds, or derivatives which might be used for efficient portfolio management (including risk hedging) and/or investment purposes, and Target Funds to benefit from a specific strategy. For those investments no environmental or social safeguards are applied.



Is a specific index designated as a reference benchmark to meet the sustainable investment objective?

No reference benchmark has been designated for the purpose of meeting the sustainable investment objective.

Reference benchmarks are indexes to measure whether the financial product attains the sustainable investment objective.

- **How does the reference benchmark take into account sustainability factors in a way that is continuously aligned with the sustainable investment objective?**
Not applicable
- **How is the alignment of the investment strategy with the methodology of the index ensured on a continuous basis?**
Not applicable
- **How does the designated index differ from a relevant broad market index?**
Not applicable
- **Where can the methodology used for the calculation of the designated index be found?**
Not applicable



Where can I find more product specific information online?

More product-specific information can be found on the website: <https://regulatory.allianzgi.com/SFDR>

Template pre-contractual disclosure for the financial products referred to in Article 9, paragraphs 1 to 4a, of Regulation (EU) 2019/2088 and Article 5, first paragraph, of Regulation (EU) 2020/852

Product name:

Allianz Better World Dynamic

Legal entity identifier: 529900APHN2CJCOLZ557

Sustainable investment objective

Sustainable investment means an investment in an economic activity that contributes to an environmental or social objective, provided that the investment does not significantly harm any environmental or social objective and that the investee companies follow good governance practices.

The EU Taxonomy is a classification system laid down in Regulation (EU) 2020/852, establishing a list of **environmentally sustainable economic activities**. That Regulation does not include a list of socially sustainable economic activities. Sustainable investments with an environmental objective might be aligned with the Taxonomy or not.

Does this financial product have a sustainable investment objective?	
Yes	No
<input checked="" type="checkbox"/> It will make a minimum of sustainable investments with an environmental objective: 14.00%	<input type="checkbox"/> It promotes Environmental/Social (E/S) characteristics and while it does not have as its objective a sustainable investment, it will have a minimum proportion of ___% of sustainable investments
<input checked="" type="checkbox"/> in economic activities that qualify as environmentally sustainable under the EU Taxonomy	<input type="checkbox"/> with an environmental objective in economic activities that qualify as environmentally sustainable under the EU Taxonomy
<input checked="" type="checkbox"/> in economic activities that do not qualify as environmentally sustainable under the EU Taxonomy	<input type="checkbox"/> with an environmental objective in economic activities that do not qualify as environmentally sustainable under the EU Taxonomy
<input checked="" type="checkbox"/> It will make a minimum of sustainable investments with a social objective 8.00%	<input type="checkbox"/> with a social objective
	<input type="checkbox"/> It promotes E/S characteristics, but will not make any sustainable investments

The Sub-Fund will invest more than 80% of its assets in Sustainable Investments and this commitment is achieved through environmentally or socially sustainable investments.



What is the sustainable investment objective of this financial product?

Allianz Better World Dynamic (the "Sub-Fund") invests in securities of companies providing products or services which contribute to environmental or social objectives, as defined by the UN Sustainable Development Goals (SDGs) or the EU Taxonomy objectives, which are also related to the SDGs. The contribution is measured according to the Sustainable Investment methodology.

In addition, sustainable minimum exclusion criteria apply.

No reference benchmark has been designated for the purpose of meeting the sustainable investment objective.

● What sustainability indicators are used to measure the attainment of the sustainable investment objective of this financial product?

To measure the attainment of the Sub-Fund's sustainable investment objective the following sustainability indicators are used and reported on, at the fiscal year end:

- The actual Sustainable Investment share – which is based on SDGs or EU Taxonomy objectives
- Principle Adverse Impacts (PAIs) of investment decisions on sustainability factors are considered through the application of exclusion criteria.

The Sustainable Investment share is based on the following methodology: Sustainable investments contribute to environmental and/or social objectives, for which the Investment Managers uses as reference

Sustainability indicators measure how the sustainable objectives of this financial product are attained.

frameworks, among others, the UN Sustainable Development Goals (SDGs), as well as the objectives of the EU Taxonomy:

1. Climate Change Mitigation
2. Climate Change Adaptation
3. Sustainable Use and Protection of Water and Marine Resources
4. Transition to a Circular Economy
5. Pollution Prevention and Control
6. Protection and Restoration of Biodiversity and Ecosystems

The assessment of the positive contribution to the environmental or social objectives is based on a proprietary framework which combines quantitative elements with qualitative inputs from internal research. The methodology applies first a quantitative breakdown of a securities issuer into its business activities. The qualitative element of the framework is an assessment if business activities contribute positively to an environmental or a social objective. To calculate the positive contribution on the Sub-Fund level the revenue share of each issuer attributable to business activities contributing to environmental and/or social objectives is considered provided the issuer is satisfying the Do No Significant Harm (“DNSH”) and Good Governance principles, and an asset-weighted aggregation is performed as a second step. Moreover, for certain types of securities, which finance specific projects contributing to environmental or social objectives the overall investment is considered to contribute to environmental and/or social objectives, but also for these a DNSH as well as a Good Governance check for issuers is performed.

● **How do sustainable investments not cause significant harm to any environmental or social sustainable investment objective?**

In order to ensure that Sustainable Investments do not significantly harm any other environmental and/or social objective, the Investment Manager is leveraging the PAI indicators, whereby significance thresholds have been defined to identify significantly harmful issuers. Issuers not meeting the significance threshold can be engaged for a limited time period to remediate the adverse impact. Otherwise, if the issuer does not meet the defined significance thresholds twice subsequently or in case of a failed engagement, it does not pass the DNSH assessment. Investments in securities of issuers which do not pass the DNSH assessment are not counted as sustainable investments.

● *How have the indicators for adverse impacts on sustainability factors been taken into account?*

All mandatory PAI indicators are considered either as part of the application of the exclusion criteria or through thresholds on a sectorial or absolute basis. Significance thresholds have been defined and they refer to qualitative or quantitative criteria.

Recognizing the lack of data coverage for some of the PAI indicators equivalent data points are used to assess PAI indicators when applying the DNSH assessment, when relevant, for the following indicators for corporates: share of non-renewable energy consumption and production, activities negatively affecting biodiversity-sensitive areas, emissions to water, lack of processes and compliance mechanisms to monitor compliance with UNGC principles and OECD Guidelines for Multinational Enterprises; for sovereigns: GHG Intensity and investee countries subject to social violations. In case of securities which finance specific projects contributing to environmental or social objectives equivalent data at project level might be used to ensure that Sustainable Investments do not significantly harm any other environmental and/or social objective. The Investment Manager will strive to increase data coverage for PAI indicators with low data coverage by engaging with issuers and data providers. The Investment Manager will regularly evaluate whether the availability of data has increased sufficiently to potentially include assessment of such data in the investment process.

● *How are the sustainable investments aligned with the OECD Guidelines for Multinational Enterprises and the UN Guiding Principles on Business and Human Rights? Details:*

The Investment Manager’s sustainable minimum exclusion list screens out companies based on their involvement in controversial practices against international norms. The core normative framework consists of the Principles of the UN Global Compact, the OECD Guidelines for Multinational Enterprises and the UN Guiding Principles for Business and Human Rights. Securities issued by companies having a severe violation of these frameworks will be restricted from the investment universe.

Principal adverse impacts are the most significant negative impacts of investment decisions on sustainability factors relating to environmental, social and employee matters, respect for human rights, anti-corruption and anti-bribery matters.



Does this financial product consider principal adverse impacts on sustainability factors?

Yes

No

The Management Company has joined the Net Zero Asset Manager Initiative and considers PAI indicators through stewardship including engagement, both are relevant to mitigate potential adverse impact as a company.

Due to the commitment to the Net Zero Asset Manager Initiative, the Management Company aims to reduce greenhouse gas emissions in partnership with asset owner clients on decarbonisation goals, consistent with an ambition to reach net zero emission by 2050 or sooner across all assets under management. As part of this objective the Management Company will set an interim target for the proportion of assets to be managed in line with the attainment of net zero emissions by 2050 or sooner.

The Sub-Fund's Investment Manager considers PAI indicators regarding greenhouse gas emission, biodiversity, water, waste as well as social and employee matters for corporate issuers, and, where relevant, the freedom house index is applied to investments in sovereigns. PAI indicators are considered within the Investment Manager's investment process through the means of exclusions as described in the "sustainable investment objective" section of the Sub-Fund.

The data coverage for the data required for the PAI indicators is heterogenous. The data coverage related to biodiversity, water and waste is low and the related PAI indicators are considered through exclusion of securities issued by companies having a severe violation / breach of principles and guidelines such as the Principles of the United Nations Global Compact, the OECD Guidelines for Multinational Enterprises, and the United Nations Guiding Principles for Business and Human Rights on the grounds of problematic practices around human rights, labour rights, environment, and corruption issues. Therefore, the Investment Manager will strive to increase data coverage for PAI indicators with low data coverage. The Investment Manager will regularly evaluate whether the availability of data has increased sufficiently to potentially include assessment of such data in the investment process.

Additionally, PAI indicators are considered as part of the requirement of the Sub-Fund to invest more than 80% into Sustainable Investments. PAI indicators are used as part of the DNSH assessment. Investments in securities of issuers who do not pass the DNSH assessment are not counted as sustainable investments.

The following PAI indicators are considered:

Applicable to corporate issuers

- GHG Emissions
- Carbon footprint
- GHG Intensity of investee companies
- Exposure to companies active in the fossil fuel sector
- Share of non-renewable energy consumption and production
- Energy consumption intensity per high impact climate sector
- Activities negatively affecting biodiversity-sensitive areas
- Emissions to water
- Hazardous waste ratio
- Violation of UN Global compact principles
- Lack of processes and compliance mechanisms to monitor compliance with UN Global Compact principles
- Unadjusted gender pay gap
- Board gender diversity
- Exposure to controversial weapons

Applicable to sovereign and supranational issuers

- GHG Intensity
- Investee countries subject to social violations

The information on the PAI indicators will be available in the end-year report of the Sub-Fund.



What investment strategy does this financial product follow?

The investment strategy guides investment decisions based on factors such as investment objectives and risk tolerance.

Allianz Better World Dynamic's investment objective is to invest in global Equity and Bond Markets with a focus on companies with an engagement in one or more United Nations' SDGs and/ or on companies supporting climate-related or social projects, and hence create positive outcomes for environment and society in accordance with the SDG-Aligned Strategy Type A.

The Sub-Fund invests in Equities and Debt Securities of companies which offer products and services across themes. Examples of such themes and topics include, but are not limited to, affordable healthcare, education, energy transition, food security, financial inclusion, water, and waste management as targeted by the SDGs, as well as in Green Bonds, Social Bonds, Sustainable Bonds and Sustainability-Linked bonds.

The assessment of the contribution to the specified SDGs is based in particular on qualitative and quantitative analysis using internal sensitivity scores and revenue attribution as sustainability indicators.

In case of certain Debt Securities which have been issued to support specific environmental, social, or sustainable projects, the respective bond proceeds and/or selection of defined SDGs-related Key Performance Indicators (KPIs) indicated in the respective applicable Green Bond Principles/ Social Bond Principles/ Sustainability-Linked Bond Principles – instead of the revenue of the respective Debt Security's issuer – are accounted for in the assessment of the contribution to the SDGs.

The Sub-Fund's general investment approach (Sub-Fund's applicable General Asset Class Principles in combination with its individual investment restrictions) is described in the prospectus.

● What are the binding elements of the investment strategy used to select the investments to attain the sustainable investment objective?

The binding elements are:

- Minimum 80% of the Sub-Fund assets' weighted average shall result from revenue generated from issuers' activities that facilitate the achievement of one or more SDG or EU Taxonomy objectives as measured according to the Sustainable Investment methodology.
- For at least 80% of Sub-Fund portfolio, the respective issuer shall have a minimum share of 20% Sustainable Investments, for the remaining 20% (or less) of the Sub-Fund portfolio, each respective issuer shall have a minimum share of at least 5% Sustainable Investment. Cash and derivatives are excluded from these thresholds.

If the Investment Manager acquires a use of proceed security, which finance specific projects contributing to environmental or social objectives, the overall investment is considered to contribute to environmental and/or social objectives according to the Sustainable Investment methodology.

- Application of the following sustainable minimum exclusion criteria for direct investments:
 - securities issued by companies having a severe violation / breach of principles and guidelines such as the Principles of the United Nations Global Compact, the OECD Guidelines for Multinational Enterprises, and the United Nations Guiding Principles for Business and Human Rights on the grounds of problematic practices around human rights, labour rights, environment, and corruption issues,
 - securities issued by companies involved in controversial weapons (anti-personnel mines, cluster munitions, chemical weapons, biological weapons, depleted uranium, white phosphorus, and nuclear weapons),
 - securities issued by companies that derive more than 10% of their revenues from weapons, military equipment, and services,
 - securities issued by companies that derive more than 10% of their revenue from thermal coal extraction,
 - securities issued by utility companies that generate more than 20% of their revenues from coal,
 - securities issued by companies involved in the production of tobacco, and securities issued by companies involved in the distribution of tobacco more with than 5% of their revenues.

Direct investments in sovereign issuers with an insufficient freedom house index score are excluded.

The sustainable minimum exclusion criteria are based on information from an external data provider and coded in pre- and post-trade compliance. The review is performed at least half yearly.

Good governance practices include sound management structures, employee relations, remuneration of staff and tax compliance.

● What is the policy to assess good governance practices of the investee companies?

Good governance principles are considered by screening out companies based on their involvement in controversies around international norms corresponding to the four good governance practices: sound management structures, employee relations, remuneration of staff and tax compliance. Companies having a severe violation in either of those areas will not be investible. For certain cases, flagged issuers shall be on a watch list. These companies will appear on this watch list when the Investment Manager believes that engagement may lead to improvements or when the company is assessed to take remedial actions. Companies on the watch list remain investible unless the Investment Manager believes that the engagement or the remedial actions of the company does not lead to the desired remedy of the severe controversy.

In addition, the Sub-Fund's Investment Manager is committed to actively encourage open dialogues with investee companies on corporate governance, proxy voting and broader sustainability issues in advance of shareholder meetings (regularly for direct investments in shares). The Sub-Fund's Investment Manager's approach to proxy voting and company engagement is set out in the Management Company's Stewardship Statement.



Asset allocation describes the share of investments in specific assets.

What is the asset allocation and the minimum share of sustainable investments?

The Sub-Fund invest primarily into securities which offer products and services to facilitate the achievements of the SDGs. The Sub-Funds will invest more than 80% of its assets in Sustainable Investments.

The minimum percentage of investments with an environmental objective is 14%. The minimum percentage of investments that are aligned with the EU Taxonomy is 0.01%. The minimum percentage of investments that are aligned with social objective is 8%.



● How does the use of derivatives attain the sustainable investment objective?

Not applicable



To what minimum extent are sustainable investments with an environmental objective aligned with the EU Taxonomy?

The Taxonomy-aligned investments include debt and/or equity in environmentally sustainable economic activities aligned with the EU-Taxonomy. The minimum percentage of investments that are aligned with the EU Taxonomy is 0.01%. Taxonomy-aligned data is provided by an external data provider. The Investment Manager has assessed the quality of such data. The data will not be subject to an assurance provided by auditors or a review by third parties. The data will not reflect any data in government bonds. As of today, there is no recognized methodology available to determine the proportion of Taxonomy-aligned activities when investing in government bonds.

Taxonomy-aligned activities in this disclosure are based on share of turnover. Pre-contractual figures use turnover as its financial metric as a default in line with the regulatory requirements and based on the fact that complete, verifiable or up-to date data for CAPEX and/or OPEX as financial metric is even less available.

Taxonomy-aligned data is only in rare cases data reported by companies in accordance with the EU Taxonomy. The data provider has derived Taxonomy-aligned data from other available equivalent public data.

Taxonomy-aligned activities are expressed as a share of:

- **turnover** reflecting the share of revenue from green activities of investee companies
- **capital expenditure** (CapEx) showing the green investments made by investee companies, e.g. for a transition to a green economy.
- **operational expenditure** (OpEx) reflecting green operational activities of investee companies.

● **Does the financial product invest in fossil gas and/or nuclear energy related activities that comply with the EU Taxonomy ¹?**

- Yes:
- In fossil gas
 - In nuclear energy
- No

The Sub-Fund does not pursue any investments in fossil gas and/or nuclear energy related activities that comply with the EU Taxonomy. Nevertheless, as result of this investment strategy, investments may occur in corporates which are also active in these activities. Further information will be provided as part of the annual reporting, if relevant.

The two graphs below show in green the minimum percentage of investments that are aligned with the EU Taxonomy. As there is no appropriate methodology to determine the Taxonomy-alignment of sovereign bonds*, the first graph shows the Taxonomy-alignment in relation to all the investments of the financial product including sovereign bonds, while the second graph shows the Taxonomy-alignment only in relation to the investments of the financial product other than sovereign bonds.

1. Taxonomy-alignment of investments including sovereign bonds*

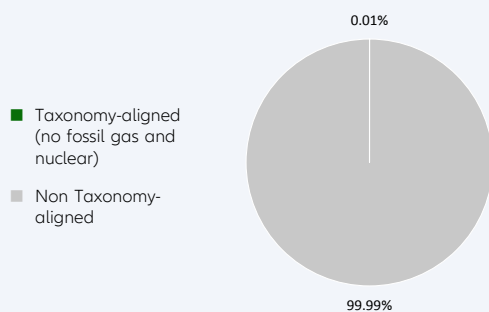

2. Taxonomy-alignment of investments excluding sovereign bonds*

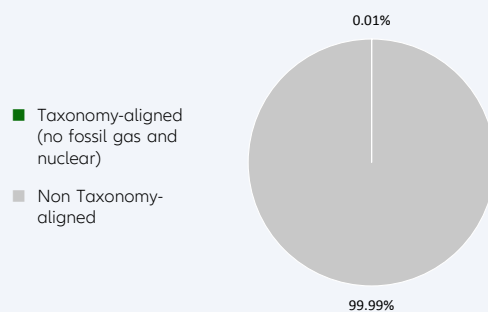

This graph represents X% of the total investments. It is noted that this Sub-Fund does not provide for a binding minimum quota for investments in sovereign bonds. Therefore, this Sub-Fund may have (but must not have) an exposure to sovereign bonds. In the absence of a binding minimum quota for investments in sovereign bonds, this graph does not generate any additional added value compared to the left-hand graph.

* For the purpose of these graphs, 'sovereign bonds' consist of all sovereign exposures

Enabling activities directly enable other activities to make a substantial contribution to an environmental objective.

● **What is the minimum share of investments in transitional and enabling activities?**

The Sub-Fund's Investment Manager does not commit to a split of minimum taxonomy alignment into transitional, enabling activities and own performance.

Transitional activities are activities for which low-carbon alternatives are not yet available and among others have greenhouse gas emission levels corresponding to the best performance.

¹ Fossil gas and/or nuclear related activities will only comply with the EU Taxonomy where they contribute to limiting climate change ("climate change mitigation") and do not significantly harm any EU Taxonomy objective - see explanatory note in the left hand margin. The full criteria for fossil gas and nuclear energy economic activities that comply with the EU Taxonomy are laid down in Commission Delegated Regulation (EU) 2022/1214.



What is the minimum share of sustainable investments with an environmental objective that are not aligned with the EU Taxonomy?

Taxonomy-aligned investments are considered a sub-category of Sustainable Investments. If an investment is not Taxonomy-aligned since the activity is not yet covered under the EU Taxonomy or the positive contribution is not substantial enough to comply with the Taxonomy technical screening criteria, the investment can still be considered an environmentally Sustainable Investment provided it complies with all criteria. The total share of environmentally Sustainable Investments including EU Taxonomy of the Sub-Fund is at least 14%. The overall sustainable investment share may also include investments with an environmental objective in economic activities that do not qualify as environmentally sustainable under the EU Taxonomy. Combined with socially Sustainable Investment the Sub-Fund will invest more than 80% of its assets in Sustainable Investments.



What is the minimum share of sustainable investments with a social objective?

The Sub-Fund's investment manager commits to a minimum share of socially Sustainable Investment of 8%. Combined with environmentally Sustainable Investment the Sub-Fund will invest more than 80% of its assets in Sustainable Investments



What investments are included under “#2 Not sustainable”, what is their purpose and are there any minimum environmental or social safeguards?

Under “#2 Not sustainable” parts of investments are included related to business activities which are not counted as Sustainable Investments. In addition, the Investment Manager might invest into cash, Targets Funds, or derivatives which might be used for efficient portfolio management (including risk hedging) and/or investment purposes, and Target Funds to benefit from a specific strategy. For those investments no environmental or social safeguards are applied.



Is a specific index designated as a reference benchmark to meet the sustainable investment objective?

No reference benchmark has been designated for the purpose of meeting the sustainable investment objective.

- How does the reference benchmark take into account sustainability factors in a way that is continuously aligned with the sustainable investment objective?

Not applicable

- How is the alignment of the investment strategy with the methodology of the index ensured on a continuous basis?

Not applicable

- How does the designated index differ from a relevant broad market index?

Not applicable

- Where can the methodology used for the calculation of the designated index be found?

Not applicable



Where can I find more product specific information online?

More product-specific information can be found on the website: <https://regulatory.allianzgi.com/SFDR>

are environmentally sustainable investments that do not take into account the criteria for environmentally sustainable economic activities under the EU Taxonomy.

Reference benchmarks are indexes to measure whether the financial product attains the sustainable investment objective.

Template pre-contractual disclosure for the financial products referred to in Article 9, paragraphs 1 to 4a, of Regulation (EU) 2019/2088 and Article 5, first paragraph, of Regulation (EU) 2020/852

Product name:

Allianz Better World Moderate

Legal entity identifier: 529900R8CZVBS2IW1189

Sustainable investment objective

Sustainable investment means an investment in an economic activity that contributes to an environmental or social objective, provided that the investment does not significantly harm any environmental or social objective and that the investee companies follow good governance practices.

The EU Taxonomy is a classification system laid down in Regulation (EU) 2020/852, establishing a list of **environmentally sustainable economic activities**. That Regulation does not include a list of socially sustainable economic activities. Sustainable investments with an environmental objective might be aligned with the Taxonomy or not.

Does this financial product have a sustainable investment objective?	
<input checked="" type="radio"/> <input checked="" type="radio"/> <input checked="" type="checkbox"/> Yes	<input type="radio"/> <input type="radio"/> <input type="checkbox"/> No
<input checked="" type="checkbox"/> It will make a minimum of sustainable investments with an environmental objective: 22.00% <ul style="list-style-type: none"> <input checked="" type="checkbox"/> in economic activities that qualify as environmentally sustainable under the EU Taxonomy <input checked="" type="checkbox"/> in economic activities that do not qualify as environmentally sustainable under the EU Taxonomy 	<input type="checkbox"/> It promotes Environmental/Social (E/S) characteristics and while it does not have as its objective a sustainable investment, it will have a minimum proportion of ___% of sustainable investments <ul style="list-style-type: none"> <input type="checkbox"/> with an environmental objective in economic activities that qualify as environmentally sustainable under the EU Taxonomy <input type="checkbox"/> with an environmental objective in economic activities that do not qualify as environmentally sustainable under the EU Taxonomy <input type="checkbox"/> with a social objective
<input checked="" type="checkbox"/> It will make a minimum of sustainable investments with a social objective 8.00%	<input type="checkbox"/> It promotes E/S characteristics, but will not make any sustainable investments

The Sub-Fund will invest more than 80% of its assets in Sustainable Investments and this commitment is achieved through environmentally or socially sustainable investments.



What is the sustainable investment objective of this financial product?

Allianz Better World Moderate's (the "Sub-Fund") invests in securities of companies providing products or services which contribute to environmental or social objectives, as defined by the UN Sustainable Development Goals (SDGs) or the EU Taxonomy objectives, which are also related to the SDGs. The contribution is measured according to the Sustainable Investment methodology.

In addition, sustainable minimum exclusion criteria apply.

No reference benchmark has been designated for the purpose of meeting the sustainable investment objective.

● What sustainability indicators are used to measure the attainment of the sustainable investment objective of this financial product?

To measure the attainment of the Sub-Fund's sustainable investment objective the following sustainability indicators are used and reported on, at the fiscal year end:

- The actual Sustainable Investment share – which is based on SDGs or EU Taxonomy objectives
- Principle Adverse Impacts (PAIs) of investment decisions on sustainability factors are considered through the application of exclusion criteria.

The Sustainable Investment share is based on the following methodology: Sustainable investments contribute to environmental and/or social objectives, for which the Investment Managers uses as reference

frameworks, among others, the UN Sustainable Development Goals (SDGs), as well as the objectives of the EU Taxonomy:

1. Climate Change Mitigation
2. Climate Change Adaptation
3. Sustainable Use and Protection of Water and Marine Resources
4. Transition to a Circular Economy
5. Pollution Prevention and Control
6. Protection and Restoration of Biodiversity and Ecosystems

The assessment of the positive contribution to the environmental or social objectives is based on a proprietary framework which combines quantitative elements with qualitative inputs from internal research. The methodology applies first a quantitative breakdown of a securities issuer into its business activities. The qualitative element of the framework is an assessment if business activities contribute positively to an environmental or a social objective. To calculate the positive contribution on the Sub-Fund level the revenue share of each issuer attributable to business activities contributing to environmental and/or social objectives is considered provided the issuer is satisfying the Do No Significant Harm (“DNSH”) and Good Governance principles, and an asset-weighted aggregation is performed as a second step. Moreover, for certain types of securities, which finance specific projects contributing to environmental or social objectives the overall investment is considered to contribute to environmental and/or social objectives, but also for these a DNSH as well as a Good Governance check for issuers is performed.

● **How do sustainable investments not cause significant harm to any environmental or social sustainable investment objective?**

In order to ensure that Sustainable Investments do not significantly harm any other environmental and/or social objective, the Investment Manager is leveraging the PAI indicators, whereby significance thresholds have been defined to identify significantly harmful issuers. Issuers not meeting the significance threshold can be engaged for a limited time period to remediate the adverse impact. Otherwise, if the issuer does not meet the defined significance thresholds twice subsequently or in case of a failed engagement, it does not pass the DNSH assessment. Investments in securities of issuers which do not pass the DNSH assessment are not counted as sustainable investments.

● *How have the indicators for adverse impacts on sustainability factors been taken into account?*

All mandatory PAI indicators are considered either as part of the application of the exclusion criteria or through thresholds on a sectorial or absolute basis. Significance thresholds have been defined and they refer to qualitative or quantitative criteria.

Recognizing the lack of data coverage for some of the PAI indicators equivalent data points are used to assess PAI indicators when applying the DNSH assessment, when relevant, for the following indicators for corporates: share of non-renewable energy consumption and production, activities negatively affecting biodiversity-sensitive areas, emissions to water, lack of processes and compliance mechanisms to monitor compliance with UNGC principles and OECD Guidelines for Multinational Enterprises; for sovereigns: GHG Intensity and investee countries subject to social violations. In case of securities which finance specific projects contributing to environmental or social objectives equivalent data at project level might be used to ensure that Sustainable Investments do not significantly harm any other environmental and/or social objective. The Investment Manager will strive to increase data coverage for PAI indicators with low data coverage by engaging with issuers and data providers. The Investment Manager will regularly evaluate whether the availability of data has increased sufficiently to potentially include assessment of such data in the investment process.

● *How are the sustainable investments aligned with the OECD Guidelines for Multinational Enterprises and the UN Guiding Principles on Business and Human Rights? Details:*

The Investment Manager’s sustainable minimum exclusion list screens out companies based on their involvement in controversial practices against international norms. The core normative framework consists of the Principles of the UN Global Compact, the OECD Guidelines for Multinational Enterprises and the UN Guiding Principles for Business and Human Rights. Securities issued by companies having a severe violation of these frameworks will be restricted from the investment universe.

Principal adverse impacts are the most significant negative impacts of investment decisions on sustainability factors relating to environmental, social and employee matters, respect for human rights, anti-corruption and anti-bribery matters.



Does this financial product consider principal adverse impacts on sustainability factors?

Yes

No

The Management Company has joined the Net Zero Asset Manager Initiative and considers PAI indicators through stewardship including engagement, both are relevant to mitigate potential adverse impact as a company.

Due to the commitment to the Net Zero Asset Manager Initiative, the Management Company aims to reduce greenhouse gas emissions in partnership with asset owner clients on decarbonisation goals, consistent with an ambition to reach net zero emission by 2050 or sooner across all assets under management. As part of this objective the Management Company will set an interim target for the proportion of assets to be managed in line with the attainment of net zero emissions by 2050 or sooner.

The Sub-Fund's Investment Manager considers PAI indicators regarding greenhouse gas emission, biodiversity, water, waste as well as social and employee matters for corporate issuers, and, where relevant, the freedom house index is applied to investments in sovereigns. PAI indicators are considered within the Investment Manager's investment process through the means of exclusions as described in the "sustainable investment objective" section of the Sub-Fund.

The data coverage for the data required for the PAI indicators is heterogenous. The data coverage related to biodiversity, water and waste is low and the related PAI indicators are considered through exclusion of securities issued by companies having a severe violation / breach of principles and guidelines such as the Principles of the United Nations Global Compact, the OECD Guidelines for Multinational Enterprises, and the United Nations Guiding Principles for Business and Human Rights on the grounds of problematic practices around human rights, labour rights, environment, and corruption issues. Therefore, the Investment Manager will strive to increase data coverage for PAI indicators with low data coverage. The Investment Manager will regularly evaluate whether the availability of data has increased sufficiently to potentially include assessment of such data in the investment process.

Additionally, PAI indicators are considered as part of the requirement of the Sub-Fund to invest more than 80% into Sustainable Investments. PAI indicators are used as part of the DNSH assessment. Investments in securities of issuers who do not pass the DNSH assessment are not counted as sustainable investments.

The following PAI indicators are considered:

Applicable to corporate issuers

- GHG Emissions
- Carbon footprint
- GHG Intensity of investee companies
- Exposure to companies active in the fossil fuel sector
- Share of non-renewable energy consumption and production
- Energy consumption intensity per high impact climate sector
- Activities negatively affecting biodiversity-sensitive areas
- Emissions to water
- Hazardous waste ratio
- Violation of UN Global compact principles
- Lack of processes and compliance mechanisms to monitor compliance with UN Global Compact principles
- Unadjusted gender pay gap
- Board gender diversity
- Exposure to controversial weapons

Applicable to sovereign and supranational issuers

- GHG Intensity
- Investee countries subject to social violations

The information on the PAI indicators will be available in the end-year report of the Sub-Fund.



What investment strategy does this financial product follow?

The investment strategy guides investment decisions based on factors such as investment objectives and risk tolerance.

Allianz Better World Moderate's investment objective is to invest in global Equity and Bond Markets with a focus on companies with an engagement in one or more United Nations' SDGs and/ or on companies supporting climate-related or social projects, and hence create positive outcomes for environment and society in accordance with the SDG-Aligned Strategy Type A. The Sub-Fund invests in Equities and Debt Securities of companies which offer products and services across themes. Examples of such themes and topics include, but are not limited to, affordable healthcare, education, energy transition, food security, financial inclusion, water, and waste management as targeted by the SDGs, as well as in Green Bonds, Social Bonds, Sustainable Bonds and Sustainability-Linked bonds.

The assessment of the contribution to the specified SDGs is based in particular on qualitative and quantitative analysis using internal sensitivity scores and revenue attribution as sustainability indicators.

In case of certain Debt Securities which have been issued to support specific environmental, social, or sustainable projects, the respective bond proceeds and/or selection of defined SDGs-related Key Performance Indicators (KPIs) indicated in the respective applicable Green Bond Principles/ Social Bond Principles/ Sustainability-Linked Bond Principles – instead of the revenue of the respective Debt Security's issuer – are accounted for in the assessment of the contribution to the SDGs.

The Sub-Fund's general investment approach (Sub-Fund's applicable General Asset Class Principles in combination with its individual investment restrictions) is described in the prospectus.

● What are the binding elements of the investment strategy used to select the investments to attain the sustainable investment objective?

The binding elements are:

- Minimum 80% of the Sub-Fund assets' weighted average shall result from revenue generated from issuers' activities that facilitate the achievement of one or more SDG or EU Taxonomy objectives as measured according to the Sustainable Investment methodology.
- For at least 80% of Sub-Fund portfolio, the respective issuer shall have a minimum share of 20% Sustainable Investments, for the remaining 20% (or less) of the Sub-Fund portfolio, each respective issuer shall have a minimum share of at least 5% Sustainable Investment. Cash and derivatives are excluded from these thresholds.

If the Investment Manager acquires a use of proceed security, which finance specific projects contributing to environmental or social objectives, the overall investment is considered to contribute to environmental and/or social objectives according to the Sustainable Investment methodology.

- Application of the following sustainable minimum exclusion criteria for direct investments:
 - securities issued by companies having a severe violation / breach of principles and guidelines such as the Principles of the United Nations Global Compact, the OECD Guidelines for Multinational Enterprises, and the United Nations Guiding Principles for Business and Human Rights on the grounds of problematic practices around human rights, labour rights, environment, and corruption issues,
 - securities issued by companies involved in controversial weapons (anti-personnel mines, cluster munitions, chemical weapons, biological weapons, depleted uranium, white phosphorus, and nuclear weapons),
 - securities issued by companies that derive more than 10% of their revenues from weapons, military equipment, and services,
 - securities issued by companies that derive more than 10% of their revenue from thermal coal extraction,
 - securities issued by utility companies that generate more than 20% of their revenues from coal,
 - securities issued by companies involved in the production of tobacco, and securities issued by companies involved in the distribution of tobacco more with than 5% of their revenues.

Direct investments in sovereign issuers with an insufficient freedom house index score are excluded.

The sustainable minimum exclusion criteria are based on information from an external data provider and coded in pre- and post-trade compliance. The review is performed at least half yearly.

Good governance practices include sound management structures, employee relations, remuneration of staff and tax compliance.

● **What is the policy to assess good governance practices of the investee companies?**

Good governance principles are considered by screening out companies based on their involvement in controversies around international norms corresponding to the four good governance practices: sound management structures, employee relations, remuneration of staff and tax compliance. Companies having a severe violation in either of those areas will not be investible. For certain cases, flagged issuers shall be on a watch list. These companies will appear on this watch list when the Investment Manager believes that engagement may lead to improvements or when the company is assessed to take remedial actions. Companies on the watch list remain investible unless the Investment Manager believes that the engagement or the remedial actions of the company does not lead to the desired remedy of the severe controversy.

In addition, the Sub-Fund’s Investment Manager is committed to actively encourage open dialogues with investee companies on corporate governance, proxy voting and broader sustainability issues in advance of shareholder meetings (regularly for direct investments in shares). The Sub-Fund’s Investment Manager’s approach to proxy voting and company engagement is set out in the Management Company’s Stewardship Statement.



Asset allocation describes the share of investments in specific assets.

What is the asset allocation and the minimum share of sustainable investments?

The Sub-Fund invest primarily into securities which offer products and services to facilitate the achievements of the SDGs. The Sub-Fund will invest more than 80% into Sustainable Investments.

The minimum percentage of investments that are aligned with environmental objective is 22%. The minimum percentage of investments that are aligned with the EU Taxonomy is 0.01%. The minimum percentage of investments that are aligned with social objective is 8%.



● **How does the use of derivatives attain the sustainable investment objective?**

Not applicable



To what minimum extent are sustainable investments with an environmental objective aligned with the EU Taxonomy?

The Taxonomy-aligned investments include debt and/or equity in environmentally sustainable economic activities aligned with the EU-Taxonomy. The minimum percentage of investments that are aligned with the EU Taxonomy is 0.01%. Taxonomy-aligned data is provided by an external data provider. The Investment Manager has assessed the quality of such data. The data will not be subject to an assurance provided by auditors or a review by third parties. The data will not reflect any data in government bonds. As of today, there is no recognized methodology available to determine the proportion of Taxonomy-aligned activities when investing in government bonds.

Taxonomy-aligned activities in this disclosure are based on share of turnover. Pre-contractual figures use turnover as its financial metric as a default in line with the regulatory requirements and based on the fact that complete, verifiable or up-to date data for CAPEX and/or OPEX as financial metric is even less available.

Taxonomy-aligned data is only in rare cases data reported by companies in accordance with the EU Taxonomy. The data provider has derived Taxonomy-aligned data from other available equivalent public data.

Taxonomy-aligned activities are expressed as a share of:
 - **turnover** reflecting the share of revenue from green activities of investee companies
 - **capital expenditure** (CapEx) showing the green investments made by investee companies, e.g. for a transition to a green economy.
 - **operational expenditure** (OpEx) reflecting green operational activities of investee companies.

● **Does the financial product invest in fossil gas and/or nuclear energy related activities that comply with the EU Taxonomy ¹?**

- Yes:
 - In fossil gas
 - In nuclear energy
- No

The Sub-Fund does not pursue any investments in fossil gas and/or nuclear energy related activities that comply with the EU Taxonomy. Nevertheless, as result of this investment strategy, investments may occur in corporates which are also active in these activities. Further information will be provided as part of the annual reporting, if relevant.

The two graphs below show in green the minimum percentage of investments that are aligned with the EU Taxonomy. As there is no appropriate methodology to determine the Taxonomy-alignment of sovereign bonds, the first graph shows the Taxonomy-alignment in relation to all the investments of the financial product including sovereign bonds, while the second graph shows the Taxonomy-alignment only in relation to the investments of the financial product other than sovereign bonds.*

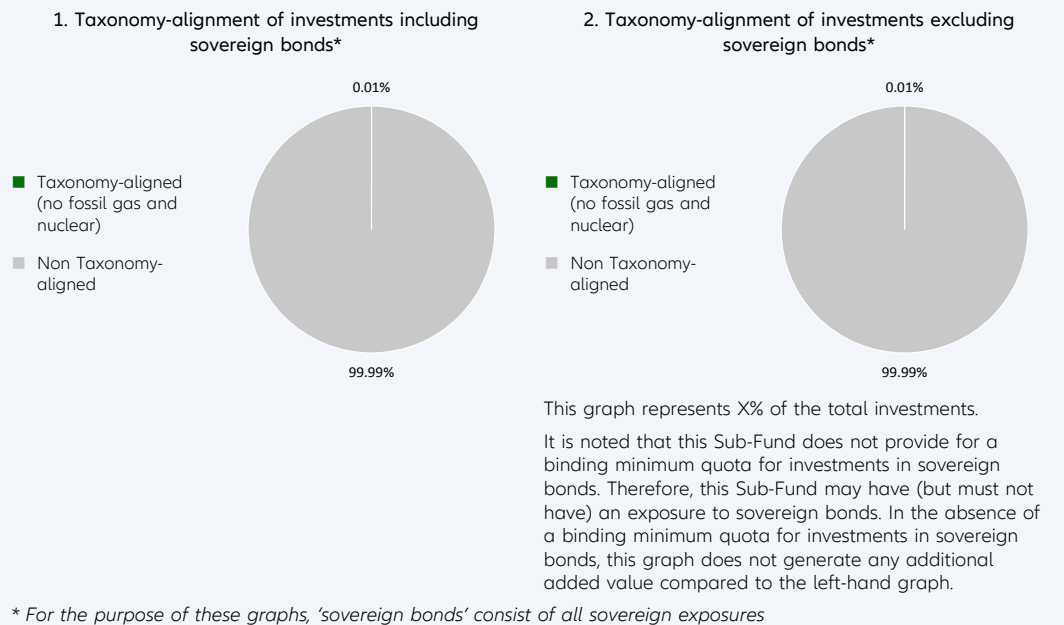

● **What is the minimum share of investments in transitional and enabling activities?**

The Sub-Fund's Investment Manager does not commit to a split of minimum taxonomy alignment into transitional, enabling activities and own performance.

Enabling activities directly enable other activities to make a substantial contribution to an environmental objective.

Transitional activities are activities for which low-carbon alternatives are not yet available and among others have greenhouse gas emission levels corresponding to the best performance.

¹ Fossil gas and/or nuclear related activities will only comply with the EU Taxonomy where they contribute to limiting climate change ("climate change mitigation") and do not significantly harm any EU Taxonomy objective - see explanatory note in the left hand margin. The full criteria for fossil gas and nuclear energy economic activities that comply with the EU Taxonomy are laid down in Commission Delegated Regulation (EU) 2022/1214.



What is the minimum share of sustainable investments with an environmental objective that are not aligned with the EU Taxonomy?

Taxonomy-aligned investments are considered a sub-category of Sustainable Investments. If an investment is not Taxonomy-aligned since the activity is not yet covered under the EU Taxonomy or the positive contribution is not substantial enough to comply with the Taxonomy technical screening criteria, the investment can still be considered an environmentally Sustainable Investment provided it complies with all criteria. The total share of environmentally Sustainable Investments including EU Taxonomy of the Sub-Fund is at least 22%. The overall sustainable investment share may also include investments with an environmental objective in economic activities that do not qualify as environmentally sustainable under the EU Taxonomy. Combined with socially Sustainable Investment the Sub-Fund will invest more than 80% of its assets in Sustainable Investments.



are environmentally sustainable investments that do not take into account the criteria for environmentally sustainable economic activities under the EU Taxonomy.



What is the minimum share of sustainable investments with a social objective?

The Sub-Fund's investment manager commits to a minimum share of socially Sustainable Investment of 8%. Combined with environmentally Sustainable Investment the Sub-Fund will invest more than 80% of its assets in Sustainable Investments



What investments are included under “#2 Not sustainable”, what is their purpose and are there any minimum environmental or social safeguards?

Under “#2 Not sustainable” parts of investments are included related to business activities which are not counted as Sustainable Investments. In addition, the Investment Manager might invest into cash, Targets Funds, or derivatives which might be used for efficient portfolio management (including risk hedging) and/or investment purposes, and Target Funds to benefit from a specific strategy. For those investments no environmental or social safeguards are applied.



Is a specific index designated as a reference benchmark to meet the sustainable investment objective?

No reference benchmark has been designated for the purpose of meeting the sustainable investment objective.

- How does the reference benchmark take into account sustainability factors in a way that is continuously aligned with the sustainable investment objective?

Not applicable

- How is the alignment of the investment strategy with the methodology of the index ensured on a continuous basis?

Not applicable

- How does the designated index differ from a relevant broad market index?

Not applicable

- Where can the methodology used for the calculation of the designated index be found?

Not applicable



Where can I find more product specific information online?

More product-specific information can be found on the website: <https://regulatory.allianzgi.com/SFDR>

Template pre-contractual disclosure for the financial products referred to in Article 8, paragraphs 1, 2 and 2a, of Regulation (EU) 2019/2088 and Article 6, first paragraph, of Regulation (EU) 2020/852

Product name:

Allianz Capital Plus

Legal entity identifier: 549300XT1DVY4H170178

Environmental and/or social characteristics

Sustainable investment means an investment in an economic activity that contributes to an environmental or social objective, provided that the investment does not significantly harm any environmental or social objective and that the investee companies follow good governance practices.

The EU Taxonomy is a classification system laid down in Regulation (EU) 2020/852, establishing a list of **environmentally sustainable economic activities**. That Regulation does not include a list of socially sustainable economic activities. Sustainable investments with an environmental objective might be aligned with the Taxonomy or not.

Does this financial product have a sustainable investment objective?	
Yes	No
<input type="checkbox"/> It will make a minimum of sustainable investments with an environmental objective: ___% <ul style="list-style-type: none"> <input type="checkbox"/> in economic activities that qualify as environmentally sustainable under the EU Taxonomy <input type="checkbox"/> in economic activities that do not qualify as environmentally sustainable under the EU Taxonomy 	<input checked="" type="checkbox"/> It promotes Environmental/Social (E/S) characteristics and while it does not have as its objective a sustainable investment, it will have a minimum proportion of 1.50% of sustainable investments <ul style="list-style-type: none"> <input checked="" type="checkbox"/> with an environmental objective in economic activities that qualify as environmentally sustainable under the EU Taxonomy <input checked="" type="checkbox"/> with an environmental objective in economic activities that do not qualify as environmentally sustainable under the EU Taxonomy <input checked="" type="checkbox"/> with a social objective
<input type="checkbox"/> It will make a minimum of sustainable investments with a social objective ___%	<input type="checkbox"/> It promotes E/S characteristics, but will not make any sustainable investments



What environmental and/or social characteristics are promoted by this financial product?

Allianz Capital Plus (the "Sub-Fund") promotes a broad range of environmental and/or social characteristics. The Sub-Fund invests at least 90% of its assets following the "Multi Asset Sustainability Strategy" which includes, but is not limited to, various sustainability strategies of the management company and/or, invests in Green Bonds and/or Social Bonds, and/or Sustainability Bonds and/or SFDR Article 8 & 9 Target Funds ("SFDR Target Funds").

Depending on the sustainability strategy selected by the Investment Manager the promoted environmental and/or social characteristics could comprise environmental, social, human rights, governance, business behaviour factors or investments in companies providing solutions that create positive environmental and social outcomes.

In addition, sustainable minimum exclusion criteria apply.

No reference benchmark has been designated for the purpose of attaining the environmental and/or social characteristics promoted by the Sub-Fund.

● What sustainability indicators are used to measure the attainment of each of the environmental or social characteristics promoted by this financial product?

As part of the Multi Asset Sustainability Strategy the Investment Manager allocates at least 90% of Fund's assets in various sustainability approaches.

Sustainability indicators measure how the environmental or social characteristics promoted by the financial product are attained.

To measure the attainment of the environmental and/or social characteristics the following sustainability indicators are used and reported on, at the fiscal year end:

- The actual percentage of the Sub-Fund's assets invested in Green Bonds, and/or Social Bonds, and/or Sustainability Bonds and/or in SFDR Target Funds and/or in Equities and/or Debt Securities in accordance with the Multi Asset Sustainability Strategy.
 - In case the Investment Manager decides to directly invest in Debt or Equity Securities as part of the Multi Asset Sustainability Strategy the adherence to the respective binding element will be reported.
 - Confirmation that Principal Adverse Impacts (PAIs) of investment decisions on sustainability factors are considered through the application of exclusion criteria (with exception of cash, derivatives, external Target Funds and internal Target Funds not following a sustainability strategy).
- **What are the objectives of the sustainable investments that the financial product partially intends to make and how does the sustainable investment contribute to such objectives?**

Sustainable investments contribute to environmental and/or social objectives, for which the Investment Manager uses as reference frameworks, among others, the UN Sustainable Development Goals (SDGs), as well as the objectives of the EU Taxonomy:

1. Climate Change Mitigation
2. Climate Change Adaptation
3. Sustainable Use and Protection of Water and Marine Resources
4. Transition to a Circular Economy
5. Pollution Prevention and Control
6. Protection and Restoration of Biodiversity and Ecosystems

The assessment of the positive contribution to the environmental or social objectives is based on a proprietary framework which combines quantitative elements with qualitative inputs from internal research. The methodology applies first a quantitative breakdown of a securities issuer into its business activities. The qualitative element of the framework is an assessment if business activities contribute positively to an environmental or a social objective.

To calculate the positive contribution on the Sub-Fund level the revenue share of each issuer attributable to business activities contributing to environmental and/or social objectives is considered provided the issuer is satisfying the Do No Significant Harm ("DNSH") and Good Governance principles, and an asset-weighted aggregation is performed as a second step. Moreover, for certain types of securities, which finance specific projects contributing to environmental or social objectives the overall investment is considered to contribute to environmental and/or social objectives, but also for these a DNSH as well as a Good Governance check for issuers is performed.

- **How do the sustainable investments that the financial product partially intends to make, not cause significant harm to any environmental or social sustainable investment objective?**

In order to ensure that Sustainable Investments do not significantly harm any other environmental and/or social objective, the Investment Manager is leveraging the PAI indicators, whereby significance thresholds have been defined to identify significantly harmful issuers. Issuers not meeting the significance threshold can be engaged for a limited time period to remediate the adverse impact. Otherwise, if the issuer does not meet the defined significance thresholds twice subsequently or in case of a failed engagement, it does not pass the DNSH assessment. Investments in securities of issuers which do not pass the DNSH assessment are not counted as sustainable investments.

- **How have the indicators for adverse impacts on sustainability factors been taken into account?**

All mandatory PAI indicators are considered either as part of the application of the exclusion criteria or through thresholds on a sectorial or absolute basis. Significance thresholds have been defined and they refer to qualitative or quantitative criteria.

Recognizing the lack of data coverage for some of the PAI indicators equivalent data points are used to assess PAI indicators when applying the DNSH assessment, when relevant, for the following indicators for corporates: share of non-renewable energy consumption and production, activities negatively affecting biodiversity-sensitive areas, emissions to water, lack of processes and compliance mechanisms to monitor compliance with UNGC principles and OECD Guidelines for Multinational Enterprises; for sovereigns: GHG Intensity and investee countries subject to social violations. In case of securities which

Principal adverse impacts are the most significant negative impacts of investment decisions on sustainability factors relating to environmental, social and employee matters, respect for human rights, anti-corruption and anti-bribery matters.

finance specific projects contributing to environmental or social objectives equivalent data at project level might be used to ensure that Sustainable Investments do not significantly harm any other environmental and/or social objective. The Investment Manager will strive to increase data coverage for PAI indicators with low data coverage by engaging with issuers and data providers. The Investment Manager will regularly evaluate whether the availability of data has increased sufficiently to potentially include assessment of such data in the investment process.

● *How are the sustainable investments aligned with the OECD Guidelines for Multinational Enterprises and the UN Guiding Principles on Business and Human Rights? Details:*

The Investment Manager's sustainable minimum exclusion list screens out companies based on their involvement in controversial practices against international norms. The core normative framework consists of the Principles of the UN Global Compact, the OECD Guidelines for Multinational Enterprises and the UN Guiding Principles for Business and Human Rights. Securities issued by companies having a severe violation of these frameworks will be restricted from the investment universe.

The EU Taxonomy sets out a "do not significant harm" principle by which Taxonomy-aligned investments should not significantly harm EU Taxonomy objectives and is accompanied by specific EU criteria.

The "do not significant harm" principle applies only to those investments underlying the financial product that take into account the EU criteria for environmentally sustainable economic activities. The investments underlying the remaining portion of this financial product do not take into account the EU criteria for environmentally sustainable economic activities.

Any other sustainable investments must also not significantly harm any environmental or social objectives.



Does this financial product consider principal adverse impacts on sustainability factors?

Yes

No

The Management Company has joined the Net Zero Asset Manager Initiative and considers PAI indicators through stewardship including engagement, both are relevant to mitigate potential adverse impact as a company.

Due to the commitment to the Net Zero Asset Manager Initiative, the Management Company aims to reduce greenhouse gas emissions in partnership with asset owner clients on decarbonisation goals, consistent with an ambition to reach net zero emission by 2050 or sooner across all assets under management. As part of this objective the Management Company will set an interim target for the proportion of assets to be managed in line with the attainment of net zero emissions by 2050 or sooner.

The Sub-Fund's Investment Manager addresses PAI indicators regarding greenhouse gas emission, biodiversity, water, waste as well as social and employee matters for corporate issuers, and, where relevant, the freedom house index is applied to investments in sovereigns. PAI indicators are considered within the Investment Manager's investment process through the means of exclusions as described in the "binding elements" section of the Sub-Fund.

The data coverage for the data required for the PAI indicators is heterogenous. The data coverage related to biodiversity, water and waste is low and the related PAI indicators are considered through exclusion of securities issued by companies having a severe violation / breach of principles and guidelines such as the Principles of the United Nations Global Compact, the OECD Guidelines for Multinational Enterprises, and the United Nations Guiding Principles for Business and Human Rights on the grounds of problematic practices around human rights, labour rights, environment, and corruption issues. Therefore, the Investment Manager will strive to increase data coverage for PAI indicators with low data coverage. The Investment Manager will regularly evaluate whether the availability of data has increased sufficiently to potentially include assessment of such data in the investment process.

The following PAI indicators are considered:

Applicable to corporate issuers

- GHG Emissions
- Carbon footprint
- GHG Intensity of investee companies
- Exposure to companies active in the fossil fuel sector

- Activities negatively affecting biodiversity-sensitive areas
- Emissions to water
- Hazardous waste ratio
- Violation of UN Global compact principles
- Lack of processes and compliance mechanisms to monitor compliance with UN Global Compact principles
- Board gender diversity
- Exposure to controversial weapons

Applicable to sovereign and supranational issuers

- Investee countries subject to social violations

The information on the PAI indicators will be available in the end-year report of the Sub-Fund.



What investment strategy does this financial product follow?

The investment strategy guides investment decisions based on factors such as investment objectives and risk tolerance.

Allianz Capital Plus's investment objective is to invest in European equity and bond markets in accordance with the Multi Asset Sustainability Strategy.

A Sub-Fund managed according to the Multi Asset Sustainability Strategy ("MAS Strategy") invests in (i) Equities and / or Debt Securities of companies that either provide for environmental and/or social characteristics and/or pursue activities contributing to an environmental or social objective and / or invests (ii) in Green Bonds and/or Social Bonds, and/or in Sustainability Bonds and/or (iii) in SFDR Target Funds.

In case of direct investments in Equities and/or Debt Securities, the Sub-Fund's Investment Manager may choose one or more of the below strategies that promote environmental and/or social characteristics and/or pursue activities contributing to an environmental or social objective:

- SRI Strategy

The Sub-Fund or strategy promotes environmental and social characteristics through integrating environmental, social, human rights, governance and business behaviour factors into the Sub-Fund's investment process through a best-in-class approach. This encompasses the evaluation of corporate or sovereign issuers based on an SRI Rating that it is used to construct the portfolio.

- Climate Engagement with Outcome Strategy

The Sub-Fund or strategy promotes environmental characteristics through the engagement with the top 10 carbon emitting issuers to encourage their transition pathway to a low carbon economy by setting objectives which are sector specific.

- SDG-Aligned & SDG-Aligned Type A Strategy

The Sub-Fund's or strategy's Sustainable Investment objective is to invest in Equities and/or in Debt Securities of companies providing solutions that create positive environmental and social outcomes, as assessed by the contribution of companies' outputs to the attainment of one or more of the SDGs or other Sustainable Investment objectives, which the Sub-Fund's Investment Manager may additionally determine and to which the companies contribute to.

- Green Bond Strategy

The Sub-Fund's or strategy's Sustainable Investment objective is to mobilize capital markets towards the transition to a low carbon society, natural capital preservation and adaptation to climate change. The Sub-Fund or strategy invests primarily in Green Bonds financing climate change mitigation or adaptation projects or other environmental sustainability projects, notably in the following fields: energy efficiency, renewable energy, raw materials, water and land, waste management, greenhouse gas emissions reduction, biodiversity preservation or circular economy.

- Green Transition Strategy

The Sub-Fund or strategy promotes environmental and/or social characteristics through the mobilization of capital markets towards the transition to a low carbon society, natural capital preservation and adaptation to climate change.

- KPI Strategy (Absolute)

A Sub-Fund or strategy managed according to the Sustainability Key Performance Indicator Strategy (Absolute) ("KPI Strategy (Absolute)") promotes environmental objectives by applying an investment objective related to an environmental key performance indicator referred to as "Sustainability KPI" to provide transparency on the measurable sustainability outcome pursued. The "Sustainability KPI" to be measured is the GHG Intensity defined by the Weighted Average GHG Intensity (Sales) of issuers included in the Fund's portfolio. GHG Intensity will be addressed by ensuring a pre-determined year-on-year improvement pathway of the weighted average GHG Intensity on Fund's portfolio level at the Fund's fiscal year ends.

- KPI Strategy (Relative)

A Sub-Fund or strategy managed according to the Sustainability Key Performance Indicator Strategy (Relative) ("KPI Strategy (Relative)") promotes environmental objectives by applying an investment objective related to an environmental key performance indicator referred to as "Sustainability KPI" to provide transparency on the measurable sustainability outcome pursued. The "Sustainability KPI" to be measured is the GHG Intensity of issuers acquired by the Fund defined by the Weighted Average GHG Intensity (Sales). GHG Intensity of the Fund will be addressed by outperforming the Fund's benchmark (respectively the Weighted Average GHG Intensity of the issuers included in the Fund's benchmark) in terms of Weighted Average GHG Intensity.

- ESG Score Strategy

A Sub-Fund or strategy managed according to the ESG Score Strategy promotes Environment, Social and Governance factors through the ESG Score Strategy. The ESG Score Strategy aims to measure a company's resilience to long-term risks across the three pillars of Environment, Social and Governance. ESG pillars will be addressed by outperforming the Weighted Average ESG Score of issuers whose shares have been acquired by the Fund against the Weighted Average ESG Score of issuers which are components of Fund's benchmark.

- KPI Strategy (Absolute Threshold)

A Sub-Fund or strategy managed according to the Sustainability Key Performance Indicator Strategy (Absolute Threshold) ("KPI Strategy (Absolute Threshold)") targets a specific minimum allocation into Sustainable Investments. Sustainable investments are investments in economic activities which contribute to environmental and/or social objectives, for which the Investment Managers uses as reference frameworks the UN Sustainable Development Goals (SDGs), as well as the objectives of the EU Taxonomy.

The Sub-Fund's general investment approach (Sub-Fund's applicable General Asset Class Principles in combination with its individual investment restrictions) is described in the prospectus.

● **What are the binding elements of the investment strategy used to select the investments to attain each of the environmental or social characteristics promoted by this financial product?**

A Sub-Fund managed according to the Multi Asset Sustainability Strategy ("MAS Strategy") invests in (i) Equities and / or Debt Securities of companies that either provide for environmental and/or social characteristics and/or pursue activities contributing to an environmental or social objective and / or invests (ii) in Green Bonds and/or Social Bonds, and/or in Sustainability Bonds and/or (iii) in SFDR Target Funds.

Overall, the Investment Manager is required to invest min 90% of Sub-Fund's assets in SFDR Target Funds and/or in Equities and/or Debt Securities in accordance with the Multi Asset Sustainability Strategy. prospective fiscal year end.

- Application of the following sustainable minimum exclusion criteria for direct investments (with exception of cash, derivatives, external Target Funds, and internal Target Funds not following a sustainable strategy):
- securities issued by companies having a severe violation / breach of principles and guidelines such as the Principles of the United Nations Global Compact, the OECD Guidelines for Multinational Enterprises, and the United Nations Guiding Principles for Business and Human Rights on the grounds of problematic practices around human rights, labour rights, environment, and corruption issues,
- securities issued by companies involved in controversial weapons (anti-personnel mines, cluster munitions, chemical weapons, biological weapons, depleted uranium, white phosphorus, and nuclear weapons),
- securities issued by companies that derive more than 10% of their revenues from weapons, military equipment, and services,
- securities issued by companies that derive more than 10% of their revenue from thermal coal extraction,
- securities issued by utility companies that generate more than 20% of their revenues from coal,

- securities issued by companies involved in the production of tobacco, and securities issued by companies involved in the distribution of tobacco with more than 5% of their revenues.

Direct investments in sovereign issuers with an insufficient freedom house index score are excluded.

The sustainable minimum exclusion criteria are based on information from an external data provider and coded in pre- and post-trade compliance. The review is performed at least half yearly.

● **What is the committed minimum rate to reduce the scope of the investments considered prior to the application of that investment strategy?**

The Sub-Fund does not commit to reduce the scope of the investments by a certain minimum rate.

● **What is the policy to assess good governance practices of the investee companies?**

Good governance principles are considered by screening out companies based on their involvement in controversies around international norms corresponding to the four good governance practices: sound management structures, employee relations, remuneration of staff and tax compliance. Companies having a severe violation in either of those areas will not be investible. For certain cases, flagged issuers shall be on a watch list. These companies will appear on this watch list when the Investment Manager believes that engagement may lead to improvements or when the company is assessed to take remedial actions. Companies on the watch list remain investible unless the Investment Manager believes that the engagement or the remedial actions of the company does not lead to the desired remedy of the severe controversy.

In addition, the Sub-Fund’s Investment Manager is committed to actively encourage open dialogues with investee companies on corporate governance, proxy voting and broader sustainability issues in advance of shareholder meetings (regularly for direct investments in shares). The Sub-Fund’s Investment Manager’s approach to proxy voting and company engagement is set out in the Management Company’s Stewardship Statement.

Good governance practices include sound management structures, employee relations, remuneration of staff and tax compliance.



What is the asset allocation planned for this financial product?

Asset allocation describes the share of investments in specific assets.

Min. 90% of the Sub-Funds’ assets are used to meet the environmental or social characteristics promoted by this Sub-Fund. A low portion of the Sub-Fund might contain assets which do not promote environmental or social characteristics. Example of such instruments are derivatives, cash and deposits, some Target Funds and investment with temporarily divergent or absent environmental, social, or good governance qualifications or investments outside of the specified quota to be invested as part of the Multi Asset Sustainability Strategy. Min. 1.50% of the Sub-Funds' assets will be invested in Sustainable Investments. The minimum percentage of investments that are aligned with the EU Taxonomy is 0.01%. The Sub-Fund’s Investment Manager does not commit to a minimum share of environmentally Sustainable Investments that are not aligned with the EU Taxonomy. The Sub-Fund’s Investment Manager does not commit to a minimum share of socially sustainable investments. While the Sub-Fund cannot commit to a minimum share of environmentally or socially sustainable investments, such investments may be freely allocated to within the Sub-Fund aggregated sustainable investment commitment disclosed (1,50%).

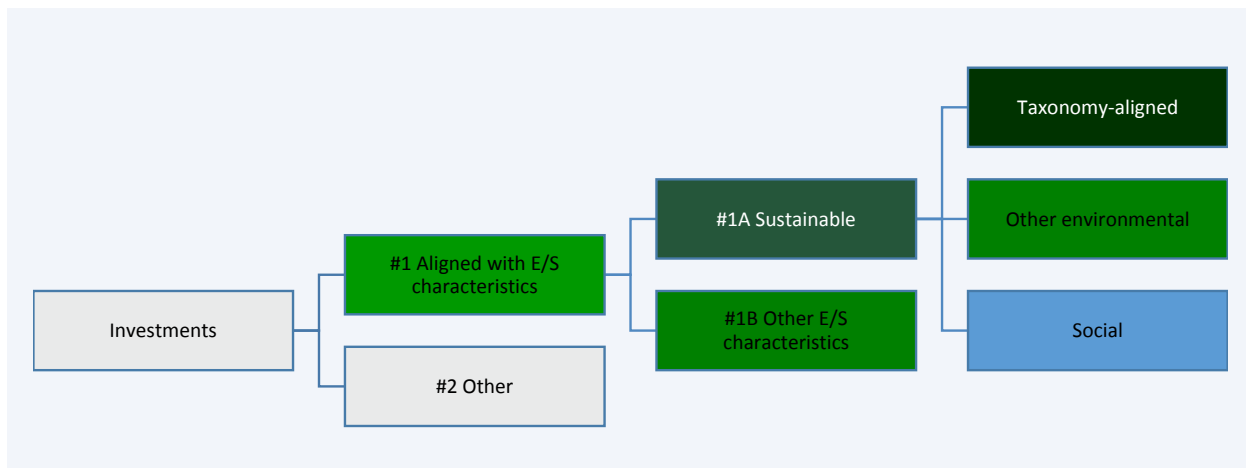

#1 Aligned with E/S characteristics includes the investments of the financial product used to attain the environmental or social characteristics promoted by the financial product.

#2 Other includes the remaining investments of the financial product which are neither aligned with the environmental or social characteristics, nor are qualified as sustainable investments.

The category **#1 Aligned with E/S characteristics** covers:

- The sub-category **#1A Sustainable** covers sustainable investments with environmental or social objectives.
- The sub-category **#1B Other E/S characteristics** covers investments aligned with the environmental or social characteristics that do not qualify as sustainable investments.

- **How does the use of derivatives attain the environmental or social characteristics promoted by the financial product?**

Not applicable



To what minimum extent are sustainable investments with an environmental objective aligned with the EU Taxonomy?

The Taxonomy-aligned investments include debt and/or equity in environmentally sustainable economic activities aligned with the EU-Taxonomy. The minimum percentage of investments that are aligned with the EU Taxonomy is 0.01%. Taxonomy-aligned data is provided by an external data provider. The Investment Manager has assessed the quality of such data. The data will not be subject to an assurance provided by auditors or a review by third parties. The data will not reflect any data in government bonds. As of today, there is no recognized methodology available to determine the proportion of Taxonomy-aligned activities when investing in government bonds.

Taxonomy-aligned activities in this disclosure are based on share of turnover. Pre-contractual figures use turnover as its financial metric as a default in line with the regulatory requirements and based on the fact that complete, verifiable or up-to date data for CAPEX and/or OPEX as financial metric is even less available.

Taxonomy-aligned data is only in rare cases data reported by companies in accordance with the EU Taxonomy. The data provider has derived Taxonomy-aligned data from other available equivalent public data.

- **Does the financial product invest in fossil gas and/or nuclear energy related activities that comply with the EU Taxonomy¹?**

Yes:

In fossil gas In nuclear energy

No

The Sub-Fund does not pursue any investments in fossil gas and/or nuclear energy related activities that comply with the EU Taxonomy. Nevertheless, as result of this investment strategy, investments may occur in corporates which are also active in these activities. Further information will be provided as part of the annual reporting, if relevant.

Taxonomy-aligned activities are expressed as a share of:

- **turnover** reflecting the share of revenue from green activities of investee companies
- **capital expenditure** (CapEx) showing the green investments made by investee companies, e.g. for a transition to a green economy.
- **operational expenditure** (OpEx) reflecting green operational activities of investee companies.

¹ Fossil gas and/or nuclear related activities will only comply with the EU Taxonomy where they contribute to limiting climate change ("climate change mitigation") and do not significantly harm any EU Taxonomy objective - see explanatory note in the left hand margin. The full criteria for fossil gas and nuclear energy economic activities that comply with the EU Taxonomy are laid down in Commission Delegated Regulation (EU) 2022/1214.

The two graphs below show in green the minimum percentage of investments that are aligned with the EU Taxonomy. As there is no appropriate methodology to determine the Taxonomy-alignment of sovereign bonds*, the first graph shows the Taxonomy-alignment in relation to all the investments of the financial product including sovereign bonds, while the second graph shows the Taxonomy-alignment only in relation to the investments of the financial product other than sovereign bonds.

1. Taxonomy-alignment of investments including sovereign bonds*

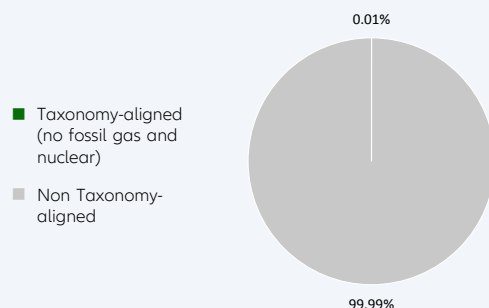

2. Taxonomy-alignment of investments excluding sovereign bonds*

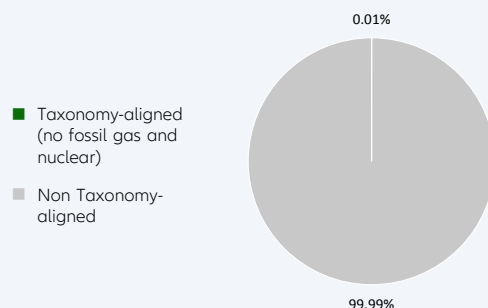

This graph represents X% of the total investments. It is noted that this Sub-Fund does not provide for a binding minimum quota for investments in sovereign bonds. Therefore, this Sub-Fund may have (but must not have) an exposure to sovereign bonds. In the absence of a binding minimum quota for investments in sovereign bonds, this graph does not generate any additional added value compared to the left-hand graph.

* For the purpose of these graphs, 'sovereign bonds' consist of all sovereign exposures

Enabling activities directly enable other activities to make a substantial contribution to an environmental objective.

Transitional activities are activities for which low-carbon alternatives are not yet available and among others have greenhouse gas emission levels corresponding to the best performance.

● **What is the minimum share of investments in transitional and enabling activities?**

The Sub-Fund's Investment Manager does not commit to a split of minimum taxonomy alignment into transitional, enabling activities and own performance.



What is the minimum share of sustainable investments with an environmental objective that are not aligned with the EU Taxonomy?

Taxonomy-aligned investments are considered a sub-category of Sustainable Investments. If an investment is not Taxonomy-aligned since the activity is not yet covered under the EU Taxonomy or the positive contribution is not substantial enough to comply with the Taxonomy technical screening criteria, the investment can still be considered an environmentally Sustainable Investment provided it complies with all criteria. The Investment Manager does not commit to a minimum share of environmentally Sustainable Investments that are not aligned with the EU Taxonomy. The overall sustainable investment share may also include investments with an environmental objective in economic activities that do not qualify as environmentally sustainable under the EU Taxonomy, and while the Sub-Fund cannot commit to a minimum share of environmentally or socially sustainable investments, such investments may be freely allocated to within the Sub-Fund aggregated sustainable investment commitment disclosed (min. 1,50%).



are sustainable investments with an environmental objective that **do not take into account the criteria** for environmentally sustainable economic activities under the EU Taxonomy.



What is the minimum share of socially sustainable investments?

The Investment Manager defines Sustainable Investments based on internal research, which uses, among others, the UN Sustainable Development Goals (SDGs), as well as the objectives of the EU Taxonomy as reference frameworks. The Investment Manager does not commit to a minimum share of socially Sustainable Investments, as the SDGs contain environmental as well as social objectives. The overall sustainable investment share may also include investments with a social objective, and while the Sub-Fund cannot commit to a minimum share of environmentally or socially sustainable investments, such investments may be freely allocated to within the Sub-Fund aggregated sustainable investment commitment disclosed (min. 1,50%).



What investments are included under “#2 Other”, what is their purpose and are there any minimum environmental or social safeguards?

Under “#2 Other” investments into cash, Target Funds, or derivatives can be included. Derivatives might be used for efficient portfolio management (including risk hedging) and/or investment purposes, and Target Funds to benefit from a specific strategy. For those investments no environmental or social safeguards are applied.



Is a specific index designated as a reference benchmark to determine whether this financial product is aligned with the environmental and/or social characteristics that it promotes?

No reference benchmark has been designated for the purpose of attaining the environmental and/or social characteristics promoted by the Sub-Fund.

- How is the reference benchmark continuously aligned with each of the environmental or social characteristics promoted by the financial product?

Not applicable

- How is the alignment of the investment strategy with the methodology of the index ensured on a continuous basis?

Not applicable

- How does the designated index differ from a relevant broad market index?

Not applicable

- Where can the methodology used for the calculation of the designated index be found?

Not applicable



Where can I find more product specific information online?

More product-specific information can be found on the website: <https://regulatory.allianzgi.com/SFDR>

Reference benchmarks are indexes to measure whether the financial product attains the environmental or social characteristics that they promote.

Template pre-contractual disclosure for the financial products referred to in Article 8, paragraphs 1, 2 and 2a, of Regulation (EU) 2019/2088 and Article 6, first paragraph, of Regulation (EU) 2020/852

Product name:

Allianz Capital Plus Global

Legal entity identifier: 529900V4Z0TX71VJR91

Environmental and/or social characteristics

Sustainable investment means an investment in an economic activity that contributes to an environmental or social objective, provided that the investment does not significantly harm any environmental or social objective and that the investee companies follow good governance practices.

The **EU Taxonomy** is a classification system laid down in Regulation (EU) 2020/852, establishing a list of **environmentally sustainable economic activities**. That Regulation does not include a list of socially sustainable economic activities. Sustainable investments with an environmental objective might be aligned with the Taxonomy or not.

Does this financial product have a sustainable investment objective?	
Yes	No
<input type="checkbox"/> It will make a minimum of sustainable investments with an environmental objective: ___% <ul style="list-style-type: none"> <input type="checkbox"/> in economic activities that qualify as environmentally sustainable under the EU Taxonomy <input type="checkbox"/> in economic activities that do not qualify as environmentally sustainable under the EU Taxonomy 	<input checked="" type="checkbox"/> It promotes Environmental/Social (E/S) characteristics and while it does not have as its objective a sustainable investment, it will have a minimum proportion of 1.50% of sustainable investments <ul style="list-style-type: none"> <input checked="" type="checkbox"/> with an environmental objective in economic activities that qualify as environmentally sustainable under the EU Taxonomy <input checked="" type="checkbox"/> with an environmental objective in economic activities that do not qualify as environmentally sustainable under the EU Taxonomy <input checked="" type="checkbox"/> with a social objective
<input type="checkbox"/> It will make a minimum of sustainable investments with a social objective ___%	<input type="checkbox"/> It promotes E/S characteristics, but will not make any sustainable investments



What environmental and/or social characteristics are promoted by this financial product?

Allianz Capital Plus Global (the “Sub-Fund”) promotes a broad range of environmental and/or social characteristics. The Sub-Fund invests at least 90% of its assets following the “Multi Asset Sustainability Strategy” which includes, but is not limited to, various sustainability strategies of the management company and/or, invests in Green Bonds and/or Social Bonds, and/or Sustainability Bonds and/or SFDR Article 8 & 9 Target Funds (“SFDR Target Funds”).

Depending on the sustainability strategy selected by the Investment Manager the promoted environmental and/or social characteristics could comprise environmental, social, human rights, governance, business behaviour factors or investments in companies providing solutions that create positive environmental and social outcomes.

In addition, sustainable minimum exclusion criteria apply.

No reference benchmark has been designated for the purpose of attaining the environmental and/or social characteristics promoted by the Sub-Fund.

- **What sustainability indicators are used to measure the attainment of each of the environmental or social characteristics promoted by this financial product?**

As part of the Multi Asset Sustainability Strategy the Investment Manager allocates at least 90% of Fund’s assets in various sustainability approaches.

Sustainability indicators measure how the environmental or social characteristics promoted by the financial product are attained.

To measure the attainment of the environmental and/or social characteristics the following sustainability indicators are used and reported on, at the fiscal year end:

- The actual percentage of the Sub-Fund's assets invested in Green Bonds, and/or Social Bonds, and/or Sustainability Bonds and/or in SFDR Target Funds and/or in Equities and/or Debt Securities in accordance with the Multi Asset Sustainability Strategy.
- In case the Investment Manager decides to directly invest in Debt or Equity Securities as part of the Multi Asset Sustainability Strategy the adherence to the respective binding element will be reported.
- Confirmation that Principal Adverse Impacts (PAIs) of investment decisions on sustainability factors are considered through the application of exclusion criteria (with exception of cash, derivatives, external Target Funds and internal Target Funds not following a sustainability strategy).

● **What are the objectives of the sustainable investments that the financial product partially intends to make and how does the sustainable investment contribute to such objectives?**

Sustainable investments contribute to environmental and/or social objectives, for which the Investment Manager uses as reference frameworks, among others, the UN Sustainable Development Goals (SDGs), as well as the objectives of the EU Taxonomy:

1. Climate Change Mitigation
2. Climate Change Adaptation
3. Sustainable Use and Protection of Water and Marine Resources
4. Transition to a Circular Economy
5. Pollution Prevention and Control
6. Protection and Restoration of Biodiversity and Ecosystems

The assessment of the positive contribution to the environmental or social objectives is based on a proprietary framework which combines quantitative elements with qualitative inputs from internal research. The methodology applies first a quantitative breakdown of a securities issuer into its business activities. The qualitative element of the framework is an assessment if business activities contribute positively to an environmental or a social objective.

To calculate the positive contribution on the Sub-Fund level the revenue share of each issuer attributable to business activities contributing to environmental and/or social objectives is considered provided the issuer is satisfying the Do No Significant Harm ("DNSH") and Good Governance principles, and an asset-weighted aggregation is performed as a second step. Moreover, for certain types of securities, which finance specific projects contributing to environmental or social objectives the overall investment is considered to contribute to environmental and/or social objectives, but also for these a DNSH as well as a Good Governance check for issuers is performed.

● **How do the sustainable investments that the financial product partially intends to make, not cause significant harm to any environmental or social sustainable investment objective?**

In order to ensure that Sustainable Investments do not significantly harm any other environmental and/or social objective, the Investment Manager is leveraging the PAI indicators, whereby significance thresholds have been defined to identify significantly harmful issuers. Issuers not meeting the significance threshold can be engaged for a limited time period to remediate the adverse impact. Otherwise, if the issuer does not meet the defined significance thresholds twice subsequently or in case of a failed engagement, it does not pass the DNSH assessment. Investments in securities of issuers which do not pass the DNSH assessment are not counted as sustainable investments.

● **How have the indicators for adverse impacts on sustainability factors been taken into account?**

All mandatory PAI indicators are considered either as part of the application of the exclusion criteria or through thresholds on a sectorial or absolute basis. Significance thresholds have been defined and they refer to qualitative or quantitative criteria.

Recognizing the lack of data coverage for some of the PAI indicators equivalent data points are used to assess PAI indicators when applying the DNSH assessment, when relevant, for the following indicators for corporates: share of non-renewable energy consumption and production, activities negatively affecting biodiversity-sensitive areas, emissions to water, lack of processes and compliance mechanisms to monitor compliance with UNGC principles and OECD Guidelines for Multinational Enterprises; for sovereigns: GHG Intensity and investee countries subject to social violations. In case of securities which

Principal adverse impacts are the most significant negative impacts of investment decisions on sustainability factors relating to environmental, social and employee matters, respect for human rights, anti-corruption and anti-bribery matters.

finance specific projects contributing to environmental or social objectives equivalent data at project level might be used to ensure that Sustainable Investments do not significantly harm any other environmental and/or social objective. The Investment Manager will strive to increase data coverage for PAI indicators with low data coverage by engaging with issuers and data providers. The Investment Manager will regularly evaluate whether the availability of data has increased sufficiently to potentially include assessment of such data in the investment process.

● *How are the sustainable investments aligned with the OECD Guidelines for Multinational Enterprises and the UN Guiding Principles on Business and Human Rights? Details:*

The Investment Manager's sustainable minimum exclusion list screens out companies based on their involvement in controversial practices against international norms. The core normative framework consists of the Principles of the UN Global Compact, the OECD Guidelines for Multinational Enterprises and the UN Guiding Principles for Business and Human Rights. Securities issued by companies having a severe violation of these frameworks will be restricted from the investment universe.

The EU Taxonomy sets out a "do not significant harm" principle by which Taxonomy-aligned investments should not significantly harm EU Taxonomy objectives and is accompanied by specific EU criteria.

The "do not significant harm" principle applies only to those investments underlying the financial product that take into account the EU criteria for environmentally sustainable economic activities. The investments underlying the remaining portion of this financial product do not take into account the EU criteria for environmentally sustainable economic activities.

Any other sustainable investments must also not significantly harm any environmental or social objectives.



Does this financial product consider principal adverse impacts on sustainability factors?

Yes

No

The Management Company has joined the Net Zero Asset Manager Initiative and considers PAI indicators through stewardship including engagement, both are relevant to mitigate potential adverse impact as a company.

Due to the commitment to the Net Zero Asset Manager Initiative, the Management Company aims to reduce greenhouse gas emissions in partnership with asset owner clients on decarbonisation goals, consistent with an ambition to reach net zero emission by 2050 or sooner across all assets under management. As part of this objective the Management Company will set an interim target for the proportion of assets to be managed in line with the attainment of net zero emissions by 2050 or sooner.

The Sub-Fund's Investment Manager addresses PAI indicators regarding greenhouse gas emission, biodiversity, water, waste as well as social and employee matters for corporate issuers, and, where relevant, the freedom house index is applied to investments in sovereigns. PAI indicators are considered within the Investment Manager's investment process through the means of exclusions as described in the "binding elements" section of the Sub-Fund.

The data coverage for the data required for the PAI indicators is heterogenous. The data coverage related to biodiversity, water and waste is low and the related PAI indicators are considered through exclusion of securities issued by companies having a severe violation / breach of principles and guidelines such as the Principles of the United Nations Global Compact, the OECD Guidelines for Multinational Enterprises, and the United Nations Guiding Principles for Business and Human Rights on the grounds of problematic practices around human rights, labour rights, environment, and corruption issues. Therefore, the Investment Manager will strive to increase data coverage for PAI indicators with low data coverage. The Investment Manager will regularly evaluate whether the availability of data has increased sufficiently to potentially include assessment of such data in the investment process.

The following PAI indicators are considered:

Applicable to corporate issuers

- GHG Emissions
- Carbon footprint
- GHG Intensity of investee companies
- Exposure to companies active in the fossil fuel sector

- Activities negatively affecting biodiversity-sensitive areas
- Emissions to water
- Hazardous waste ratio
- Violation of UN Global compact principles
- Lack of processes and compliance mechanisms to monitor compliance with UN Global Compact principles
- Board gender diversity
- Exposure to controversial weapons

Applicable to sovereign and supranational issuers

- Investee countries subject to social violations

The information on the PAI indicators will be available in the end-year report of the Sub-Fund.



What investment strategy does this financial product follow?

The investment strategy guides investment decisions based on factors such as investment objectives and risk tolerance.

Allianz Capital Plus Global's investment objective is to invest in Global Equity and Bond Markets in accordance with the Multi Asset Sustainability Strategy. A Sub-Fund managed according to the Multi Asset Sustainability Strategy ("MAS Strategy") invests in (i) Equities and / or Debt Securities of companies that either provide for environmental and/or social characteristics and/or pursue activities contributing to an environmental or social objective and / or invests (ii) in Green Bonds and/or Social Bonds, and/or in Sustainability Bonds and/or (iii) in SFDR Target Funds.

In case of direct investments in Equities and/or Debt Securities, the Sub-Fund's Investment Manager may choose one or more of the below strategies that promote environmental and/or social characteristics and/or pursue activities contributing to an environmental or social objective:

- SRI Strategy

The Sub-Fund or strategy promotes environmental and social characteristics through integrating environmental, social, human rights, governance and business behaviour factors into the Sub-Fund's investment process through a best-in-class approach. This encompasses the evaluation of corporate or sovereign issuers based on an SRI Rating that it is used to construct the portfolio.

- Climate Engagement with Outcome Strategy

The Sub-Fund or strategy promotes environmental characteristics through the engagement with the top 10 carbon emitting issuers to encourage their transition pathway to a low carbon economy by setting objectives which are sector specific.

- SDG-Aligned & SDG-Aligned Type A Strategy

The Sub-Fund's or strategy's Sustainable Investment objective is to invest in Equities and/or in Debt Securities of companies providing solutions that create positive environmental and social outcomes, as assessed by the contribution of companies' outputs to the attainment of one or more of the SDGs or other Sustainable Investment objectives, which the Sub-Fund's Investment Manager may additionally determine and to which the companies contribute to.

- Green Bond Strategy

The Sub-Fund's or strategy's Sustainable Investment objective is to mobilize capital markets towards the transition to a low carbon society, natural capital preservation and adaptation to climate change. The Sub-Fund or strategy invests primarily in Green Bonds financing climate change mitigation or adaptation projects or other environmental sustainability projects, notably in the following fields: energy efficiency, renewable energy, raw materials, water and land, waste management, greenhouse gas emissions reduction, biodiversity preservation or circular economy.

- Green Transition Strategy

The Sub-Fund or strategy promotes environmental and/or social characteristics through the mobilization of capital markets towards the transition to a low carbon society, natural capital preservation and adaptation to climate change.

- KPI Strategy (Absolute)

A Sub-Fund or strategy managed according to the Sustainability Key Performance Indicator Strategy (Absolute) ("KPI Strategy (Absolute)") promotes environmental objectives by applying an investment objective related to an environmental key performance indicator referred to as "Sustainability KPI" to provide transparency on the measurable sustainability outcome pursued. The "Sustainability KPI" to be measured is the GHG Intensity defined by the Weighted Average GHG Intensity (Sales) of issuers included in the Fund's portfolio. GHG Intensity will be addressed by ensuring a pre-determined year-on-year improvement pathway of the weighted average GHG Intensity on Fund's portfolio level at the Fund's fiscal year ends.

- KPI Strategy (Relative)

A Sub-Fund or strategy managed according to the Sustainability Key Performance Indicator Strategy (Relative) ("KPI Strategy (Relative)") promotes environmental objectives by applying an investment objective related to an environmental key performance indicator referred to as "Sustainability KPI" to provide transparency on the measurable sustainability outcome pursued. The "Sustainability KPI" to be measured is the GHG Intensity of issuers acquired by the Fund defined by the Weighted Average GHG Intensity (Sales). GHG Intensity of the Fund will be addressed by outperforming the Fund's benchmark (respectively the Weighted Average GHG Intensity of the issuers included in the Fund's benchmark) in terms of Weighted Average GHG Intensity.

- ESG Score Strategy

A Sub-Fund or strategy managed according to the ESG Score Strategy promotes Environment, Social and Governance factors through the ESG Score Strategy. The ESG Score Strategy aims to measure a company's resilience to long-term risks across the three pillars of Environment, Social and Governance. ESG pillars will be addressed by outperforming the Weighted Average ESG Score of issuers whose shares have been acquired by the Fund against the Weighted Average ESG Score of issuers which are components of Fund's benchmark.

- KPI Strategy (Absolute Threshold)

A Sub-Fund or strategy managed according to the Sustainability Key Performance Indicator Strategy (Absolute Threshold) ("KPI Strategy (Absolute Threshold)") targets a specific minimum allocation into Sustainable Investments. Sustainable investments are investments in economic activities which contribute to environmental and/or social objectives, for which the Investment Managers uses as reference frameworks the UN Sustainable Development Goals (SDGs), as well as the objectives of the EU Taxonomy.

The Sub-Fund's general investment approach (Sub-Fund's applicable General Asset Class Principles in combination with its individual investment restrictions) is described in the prospectus.

● **What are the binding elements of the investment strategy used to select the investments to attain each of the environmental or social characteristics promoted by this financial product?**

A Sub-Fund managed according to the Multi Asset Sustainability Strategy ("MAS Strategy") invests in (i) Equities and / or Debt Securities of companies that either provide for environmental and/or social characteristics and/or pursue activities contributing to an environmental or social objective and / or invests (ii) in Green Bonds and/or Social Bonds, and/or in Sustainability Bonds and/or (iii) in SFDR Target Funds.

Overall, the Investment Manager is required to invest min 90% of Sub-Fund's assets in SFDR Target Funds and/or in Equities and/or Debt Securities in accordance with the Multi Asset Sustainability Strategy.

- Application of the following sustainable minimum exclusion criteria for direct investments (with exception of cash, derivatives, external Target Funds, and internal Target Funds not following a sustainable strategy):
- securities issued by companies having a severe violation / breach of principles and guidelines such as the Principles of the United Nations Global Compact, the OECD Guidelines for Multinational Enterprises, and the United Nations Guiding Principles for Business and Human Rights on the grounds of problematic practices around human rights, labour rights, environment, and corruption issues,
- securities issued by companies involved in controversial weapons (anti-personnel mines, cluster munitions, chemical weapons, biological weapons, depleted uranium, white phosphorus, and nuclear weapons),
- securities issued by companies that derive more than 10% of their revenues from weapons, military equipment, and services,
- securities issued by companies that derive more than 10% of their revenue from thermal coal extraction,
- securities issued by utility companies that generate more than 20% of their revenues from coal,
- securities issued by companies involved in the production of tobacco, and securities issued by companies involved in the distribution of tobacco with more than 5% of their revenues.

Direct investments in sovereign issuers with an insufficient freedom house index score are excluded.

The sustainable minimum exclusion criteria are based on information from an external data provider and coded in pre- and post-trade compliance. The review is performed at least half yearly.

- **What is the committed minimum rate to reduce the scope of the investments considered prior to the application of that investment strategy?**

The Sub-Fund does not commit to reduce the scope of the investments by a certain minimum rate.

- **What is the policy to assess good governance practices of the investee companies?**

Good governance principles are considered by screening out companies based on their involvement in controversies around international norms corresponding to the four good governance practices: sound management structures, employee relations, remuneration of staff and tax compliance. Companies having a severe violation in either of those areas will not be investible. For certain cases, flagged issuers shall be on a watch list. These companies will appear on this watch list when the Investment Manager believes that engagement may lead to improvements or when the company is assessed to take remedial actions. Companies on the watch list remain investible unless the Investment Manager believes that the engagement or the remedial actions of the company does not lead to the desired remedy of the severe controversy.

In addition, the Sub-Fund's Investment Manager is committed to actively encourage open dialogues with investee companies on corporate governance, proxy voting and broader sustainability issues in advance of shareholder meetings (regularly for direct investments in shares). The Sub-Fund's Investment Manager's approach to proxy voting and company engagement is set out in the Management Company's Stewardship Statement.

Good governance practices include sound management structures, employee relations, remuneration of staff and tax compliance.



What is the asset allocation planned for this financial product?

Asset allocation describes the share of investments in specific assets.

Min. 90% of the Sub-Funds' assets are used to meet the environmental or social characteristics promoted by this Sub-Fund. A low portion of the Sub-Fund might contain assets which do not promote environmental or social characteristics. Example of such instruments are derivatives, cash and deposits, some Target Funds and investment with temporarily divergent or absent environmental, social, or good governance qualifications or investments outside of the specified quota to be invested as part of the Multi Asset Sustainability Strategy. Min. 1.50% of the Sub-Funds' assets will be invested in Sustainable Investments. The minimum percentage of investments that are aligned with the EU Taxonomy is 0.01%. The Sub-Fund's Investment Manager does not commit to a minimum share of environmentally Sustainable Investments that are not aligned with the EU Taxonomy. The Sub-Fund's Investment Manager does not commit to a minimum share of socially sustainable investments. While the Sub-Fund cannot commit to a minimum share of environmentally or socially sustainable investments, such investments may be freely allocated to within the Sub-Fund aggregated sustainable investment commitment disclosed (min. 1,50%).

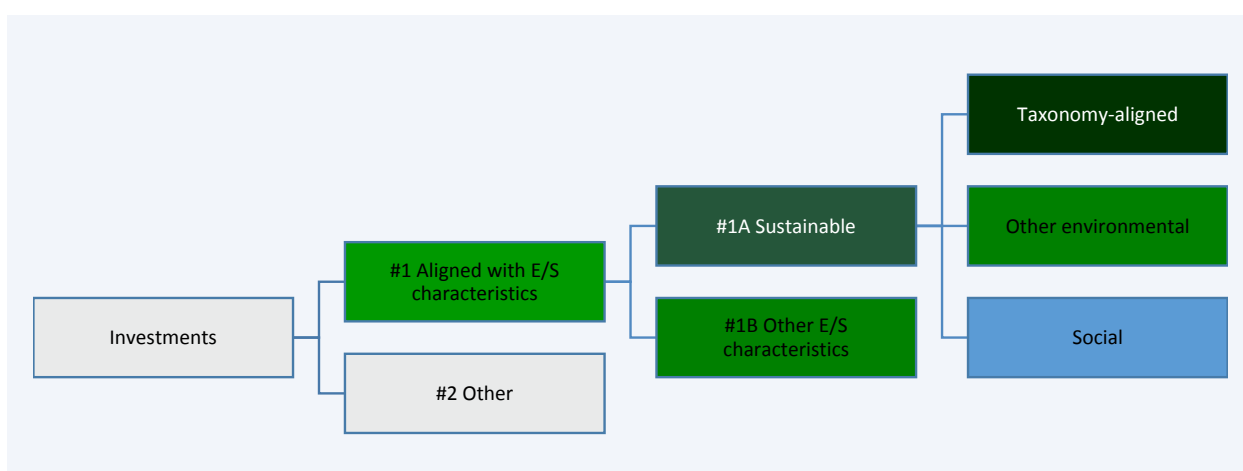

#1 Aligned with E/S characteristics includes the investments of the financial product used to attain the environmental or social characteristics promoted by the financial product.

#2 Other includes the remaining investments of the financial product which are neither aligned with the environmental or social characteristics, nor are qualified as sustainable investments.

The category #1 Aligned with E/S characteristics covers:
 - The sub-category #1A Sustainable covers sustainable investments with environmental or social objectives.
 - The sub-category #1B Other E/S characteristics covers investments aligned with the environmental or social characteristics that do not qualify as sustainable investments.

● How does the use of derivatives attain the environmental or social characteristics promoted by the financial product?

Not applicable



To what minimum extent are sustainable investments with an environmental objective aligned with the EU Taxonomy?

The Taxonomy-aligned investments include debt and/or equity in environmentally sustainable economic activities aligned with the EU-Taxonomy. The minimum percentage of investments that are aligned with the EU Taxonomy is 0.01%. Taxonomy-aligned data is provided by an external data provider. The Investment Manager has assessed the quality of such data. The data will not be subject to an assurance provided by auditors or a review by third parties. The data will not reflect any data in government bonds. As of today, there is no recognized methodology available to determine the proportion of Taxonomy-aligned activities when investing in government bonds.

Taxonomy-aligned activities in this disclosure are based on share of turnover. Pre-contractual figures use turnover as its financial metric as a default in line with the regulatory requirements and based on the fact that complete, verifiable or up-to date data for CAPEX and/or OPEX as financial metric is even less available.

Taxonomy-aligned data is only in rare cases data reported by companies in accordance with the EU Taxonomy. The data provider has derived Taxonomy-aligned data from other available equivalent public data.

● Does the financial product invest in fossil gas and/or nuclear energy related activities that comply with the EU Taxonomy ¹?

- Yes:
 - In fossil gas
 - In nuclear energy
- No

The Sub-Fund does not pursue any investments in fossil gas and/or nuclear energy related activities that comply with the EU Taxonomy. Nevertheless, as result of this investment strategy, investments may occur in corporates which are also active in these activities. Further information will be provided as part of the annual reporting, if relevant.

The two graphs below show in green the minimum percentage of investments that are aligned with the EU Taxonomy. As there is no appropriate methodology to determine the Taxonomy-alignment of sovereign bonds*, the first graph shows the Taxonomy-alignment in relation to all the investments of the financial product including sovereign bonds, while the second graph shows the Taxonomy-alignment only in relation to the investments of the financial product other than sovereign bonds.

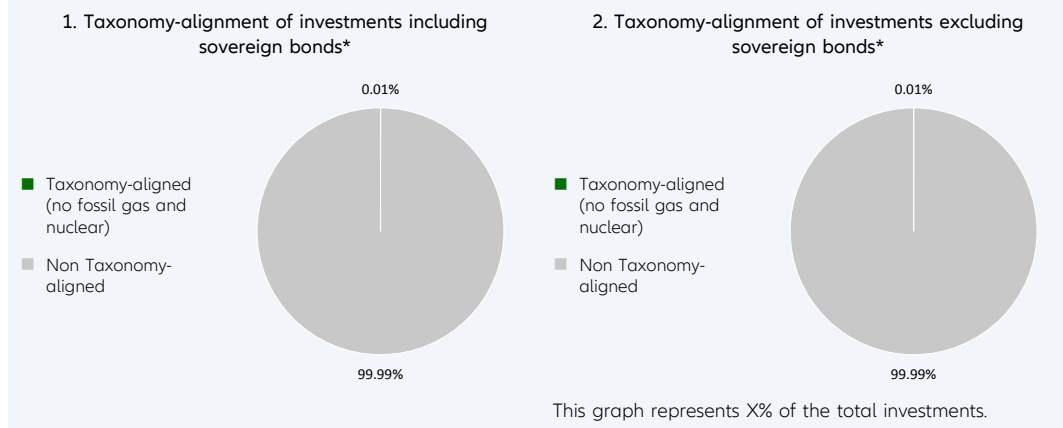

Taxonomy-aligned activities are expressed as a share of:
 - **turnover** reflecting the share of revenue from green activities of investee companies
 - **capital expenditure (CapEx)** showing the green investments made by investee companies, e.g. for a transition to a green economy.
 - **operational expenditure (OpEx)** reflecting green operational activities of investee companies.

¹ Fossil gas and/or nuclear related activities will only comply with the EU Taxonomy where they contribute to limiting climate change ("climate change mitigation") and do not significantly harm any EU Taxonomy objective - see explanatory note in the left hand margin. The full criteria for fossil gas and nuclear energy economic activities that comply with the EU Taxonomy are laid down in Commission Delegated Regulation (EU) 2022/1214.

It is noted that this Sub-Fund does not provide for a binding minimum quota for investments in sovereign bonds. Therefore, this Sub-Fund may have (but must not have) an exposure to sovereign bonds. In the absence of a binding minimum quota for investments in sovereign bonds, this graph does not generate any additional added value compared to the left-hand graph.

* For the purpose of these graphs, 'sovereign bonds' consist of all sovereign exposures

Enabling activities directly enable other activities to make a substantial contribution to an environmental objective.

Transitional activities are activities for which low-carbon alternatives are not yet available and among others have greenhouse gas emission levels corresponding to the best performance.

● What is the minimum share of investments in transitional and enabling activities?

The Sub-Fund's Investment Manager does not commit to a split of minimum taxonomy alignment into transitional, enabling activities and own performance.



What is the minimum share of sustainable investments with an environmental objective that are not aligned with the EU Taxonomy?

Taxonomy-aligned investments are considered a sub-category of Sustainable Investments. If an investment is not Taxonomy-aligned since the activity is not yet covered under the EU Taxonomy or the positive contribution is not substantial enough to comply with the Taxonomy technical screening criteria, the investment can still be considered an environmentally Sustainable Investment provided it complies with all criteria. The Investment Manager does not commit to a minimum share of environmentally Sustainable Investments that are not aligned with the EU Taxonomy. The overall sustainable investment share may also include investments with an environmental objective in economic activities that do not qualify as environmentally sustainable under the EU Taxonomy, and while the Sub-Fund cannot commit to a minimum share of environmentally or socially sustainable investments, such investments may be freely allocated to within the Sub-Fund aggregated sustainable investment commitment disclosed (min. 1,50%).



are sustainable investments with an environmental objective that **do not take into account the criteria** for environmentally sustainable economic activities under the EU Taxonomy.



What is the minimum share of socially sustainable investments?

The Investment Manager defines Sustainable Investments based on internal research, which uses, among others, the UN Sustainable Development Goals (SDGs), as well as the objectives of the EU Taxonomy as reference frameworks. The Investment Manager does not commit to a minimum share of socially Sustainable Investments, as the SDGs contain environmental as well as social objectives. The overall sustainable investment share may also include investments with a social objective, and while the Sub-Fund cannot commit to a minimum share of environmentally or socially sustainable investments, such investments may be freely allocated to within the Sub-Fund aggregated sustainable investment commitment disclosed (min. 1,50%).



What investments are included under "#2 Other", what is their purpose and are there any minimum environmental or social safeguards?

Under "#2 Other" investments into cash, Target Funds, or derivatives can be included. Derivatives might be used for efficient portfolio management (including risk hedging) and/or investment purposes, and Target Funds to benefit from a specific strategy. For those investments no environmental or social safeguards are applied.



Is a specific index designated as a reference benchmark to determine whether this financial product is aligned with the environmental and/or social characteristics that it promotes?

No reference benchmark has been designated for the purpose of attaining the environmental and/or social characteristics promoted by the Sub-Fund.

Reference benchmarks are indexes to measure whether the financial product attains the environmental or social characteristics that they promote.

- How is the reference benchmark continuously aligned with each of the environmental or social characteristics promoted by the financial product?
Not applicable
- How is the alignment of the investment strategy with the methodology of the index ensured on a continuous basis?
Not applicable
- How does the designated index differ from a relevant broad market index?
Not applicable
- Where can the methodology used for the calculation of the designated index be found?
Not applicable



Where can I find more product specific information online?

More product-specific information can be found on the website: <https://regulatory.allianzgi.com/SFDR>

Template pre-contractual disclosure for the financial products referred to in Article 8, paragraphs 1, 2 and 2a, of Regulation (EU) 2019/2088 and Article 6, first paragraph, of Regulation (EU) 2020/852

Product name:

Allianz China A Opportunities

Legal entity identifier: 529900SR5WUFEB6J7646

Environmental and/or social characteristics

Sustainable investment means an investment in an economic activity that contributes to an environmental or social objective, provided that the investment does not significantly harm any environmental or social objective and that the investee companies follow good governance practices.

The EU Taxonomy is a classification system laid down in Regulation (EU) 2020/852, establishing a list of **environmentally sustainable economic activities**. That Regulation does not include a list of socially sustainable economic activities. Sustainable investments with an environmental objective might be aligned with the Taxonomy or not.

Does this financial product have a sustainable investment objective?

Yes

No

It will make a minimum of **sustainable investments with an environmental objective**: ___%

in economic activities that qualify as environmentally sustainable under the EU Taxonomy

in economic activities that do not qualify as environmentally sustainable under the EU Taxonomy

It will make a minimum of **sustainable investments with a social objective** ___%

It promotes **Environmental/Social (E/S) characteristics** and while it does not have as its objective a sustainable investment, it will have a minimum proportion of **5.00%** of sustainable investments

with an environmental objective in economic activities that qualify as environmentally sustainable under the EU Taxonomy

with an environmental objective in economic activities that do not qualify as environmentally sustainable under the EU Taxonomy

with a social objective

It promotes E/S characteristics, but **will not make any sustainable investments**



What environmental and/or social characteristics are promoted by this financial product?

Allianz China A Opportunities (the "Sub-Fund") promotes Environment, Social and Governance factors through the ESG Score Strategy. The ESG Score Strategy aims to measure a company's resilience to long-term risks across the three pillars of Environment, Social and Governance. ESG pillars will be addressed by outperforming the Weighted Average ESG Score of issuers whose shares have been acquired by the Sub-Fund against the Weighted Average ESG Score of issuers which are components of Sub-Fund's benchmark.

In addition, sustainable minimum exclusion criteria apply.

A reference benchmark has been designated for the purpose of attaining the environmental or social characteristics promoted by the Sub-Fund.

● What sustainability indicators are used to measure the attainment of each of the environmental or social characteristics promoted by this financial product?

To measure the attainment of the environmental and/or social characteristics the following sustainability indicators are used and reported on, at the fiscal year end:

- The actual percentage of ESG Score coverage of the Sub-Fund's Portfolio (Portfolio in this respect does not comprise derivatives and instruments that are non-evaluated by nature (e. g., cash and deposits)).
- The weighted average ESG Score of the portfolio vs the weighted average ESG Score of the benchmark.

Sustainability indicators measure how the environmental or social characteristics promoted by the financial product are attained.

- Confirmation that Principal Adverse Impacts (PAIs) of investment decisions on sustainability factors are considered through the application of exclusion criteria.

- **What are the objectives of the sustainable investments that the financial product partially intends to make and how does the sustainable investment contribute to such objectives?**

Sustainable investments contribute to environmental and/or social objectives, for which the Investment Manager uses as reference frameworks, among others, the UN Sustainable Development Goals (SDGs), as well as the objectives of the EU Taxonomy:

1. Climate Change Mitigation
2. Climate Change Adaptation
3. Sustainable Use and Protection of Water and Marine Resources
4. Transition to a Circular Economy
5. Pollution Prevention and Control
6. Protection and Restoration of Biodiversity and Ecosystems

The assessment of the positive contribution to the environmental or social objectives is based on a proprietary framework which combines quantitative elements with qualitative inputs from internal research. The methodology applies first a quantitative breakdown of a securities issuer into its business activities. The qualitative element of the framework is an assessment if business activities contribute positively to an environmental or a social objective.

To calculate the positive contribution on the Sub-Fund level the revenue share of each issuer attributable to business activities contributing to environmental and/or social objectives is considered provided the issuer is satisfying the Do No Significant Harm (“DNSH”) and Good Governance principles, and an asset-weighted aggregation is performed as a second step. Moreover, for certain types of securities, which finance specific projects contributing to environmental or social objectives the overall investment is considered to contribute to environmental and/or social objectives, but also for these a DNSH as well as a Good Governance check for issuers is performed.

- **How do the sustainable investments that the financial product partially intends to make, not cause significant harm to any environmental or social sustainable investment objective?**

In order to ensure that Sustainable Investments do not significantly harm any other environmental and/or social objective, the Investment Manager is leveraging the PAI indicators, whereby significance thresholds have been defined to identify significantly harmful issuers. Issuers not meeting the significance threshold can be engaged for a limited time period to remediate the adverse impact. Otherwise, if the issuer does not meet the defined significance thresholds twice subsequently or in case of a failed engagement, it does not pass the DNSH assessment. Investments in securities of issuers which do not pass the DNSH assessment are not counted as sustainable investments.

- *How have the indicators for adverse impacts on sustainability factors been taken into account?*

All mandatory PAI indicators are considered either as part of the application of the exclusion criteria or through thresholds on a sectorial or absolute basis. Significance thresholds have been defined and they refer to qualitative or quantitative criteria.

Recognizing the lack of data coverage for some of the PAI indicators equivalent data points are used to assess PAI indicators when applying the DNSH assessment, when relevant, for the following indicators for corporates: share of non-renewable energy consumption and production, activities negatively affecting biodiversity-sensitive areas, emissions to water, lack of processes and compliance mechanisms to monitor compliance with UNGC principles and OECD Guidelines for Multinational Enterprises; for sovereigns: GHG Intensity and investee countries subject to social violations. In case of securities which finance specific projects contributing to environmental or social objectives equivalent data at project level might be used to ensure that Sustainable Investments do not significantly harm any other environmental and/or social objective. The Investment Manager will strive to increase data coverage for PAI indicators with low data coverage by engaging with issuers and data providers. The Investment Manager will regularly evaluate whether the availability of data has increased sufficiently to potentially include assessment of such data in the investment process.

Principal adverse impacts are the most significant negative impacts of investment decisions on sustainability factors relating to environmental, social and employee matters, respect for human rights, anti-corruption and anti-bribery matters.

- *How are the sustainable investments aligned with the OECD Guidelines for Multinational Enterprises and the UN Guiding Principles on Business and Human Rights? Details:*

The Investment Manager's sustainable minimum exclusion list screens out companies based on their involvement in controversial practices against international norms. The core normative framework consists of the Principles of the UN Global Compact, the OECD Guidelines for Multinational Enterprises and the UN Guiding Principles for Business and Human Rights. Securities issued by companies having a severe violation of these frameworks will be restricted from the investment universe.

The EU Taxonomy sets out a "do not significant harm" principle by which Taxonomy-aligned investments should not significantly harm EU Taxonomy objectives and is accompanied by specific EU criteria.

The "do not significant harm" principle applies only to those investments underlying the financial product that take into account the EU criteria for environmentally sustainable economic activities. The investments underlying the remaining portion of this financial product do not take into account the EU criteria for environmentally sustainable economic activities.

Any other sustainable investments must also not significantly harm any environmental or social objectives.



Does this financial product consider principal adverse impacts on sustainability factors?

Yes

No

The Management Company has joined the Net Zero Asset Manager Initiative and considers PAI indicators through stewardship including engagement, both are relevant to mitigate potential adverse impact as a company.

Due to the commitment to the Net Zero Asset Manager Initiative, the Management Company aims to reduce greenhouse gas emissions in partnership with asset owner clients on decarbonisation goals, consistent with an ambition to reach net zero emission by 2050 or sooner across all assets under management. As part of this objective the Management Company will set an interim target for the proportion of assets to be managed in line with the attainment of net zero emissions by 2050 or sooner.

The Sub-Fund's Investment Manager addresses PAI indicators regarding greenhouse gas emission, biodiversity, water, waste as well as social and employee matters for corporate issuers, and, where relevant, the freedom house index is applied to investments in sovereigns. PAI indicators are considered within the Investment Manager's investment process through the means of exclusions as described in the "binding elements" section of the Sub-Fund.

The data coverage for the data required for the PAI indicators is heterogenous. The data coverage related to biodiversity, water and waste is low and the related PAI indicators are considered through exclusion of securities issued by companies having a severe violation / breach of principles and guidelines such as the Principles of the United Nations Global Compact, the OECD Guidelines for Multinational Enterprises, and the United Nations Guiding Principles for Business and Human Rights on the grounds of problematic practices around human rights, labour rights, environment, and corruption issues. Therefore, the Investment Manager will strive to increase data coverage for PAI indicators with low data coverage. The Investment Manager will regularly evaluate whether the availability of data has increased sufficiently to potentially include assessment of such data in the investment process.

Additionally, PAI indicators are, among other sustainability factors, applied in the ESG Score. The ESG Score is used for the portfolio construction.

The following PAI indicators are considered:

Applicable to corporate issuers

- GHG Emissions
- Carbon footprint
- GHG Intensity of investee companies
- Exposure to companies active in the fossil fuel sector
- Activities negatively affecting biodiversity-sensitive areas
- Emissions to water
- Hazardous waste ratio

- Violation of UN Global compact principles
- Lack of processes and compliance mechanisms to monitor compliance with UN Global Compact principles
- Board gender diversity
- Exposure to controversial weapons

Applicable to sovereign and supranational issuers

- Investee countries subject to social violations

The information on the PAI indicators will be available in the end-year report of the Sub-Fund.



What investment strategy does this financial product follow?

The investment strategy guides investment decisions based on factors such as investment objectives and risk tolerance.

Allianz China A Opportunities' investment objective is to invest in China A-Shares Equity Markets of the PRC with a focus on large capitalization companies in accordance with the ESG Score Strategy. The Sub-Fund promotes Environment, Social and Governance factors through the ESG Score Strategy. Aim of the strategy is to outperform the weighted average ESG Score against its benchmark. The outperformance is determined as the excess between the Sub-Fund's weighted average ESG Score and the Sub-Fund's benchmark weighted average ESG Score. The ESG Score is comprised of the pillars Environment, Social and Governance. The portfolio and benchmark weights are rebased such that only issuers with ESG Scores available are considered in the calculation.

The proportion of assets which do not have a ESG Score is expected to be low. Examples of instruments not having a ESG Score are cash and deposits, some Target Funds, and investments for which the ESG Score is deemed to be not appropriate and/or data is not available.

The Sub-Fund's general investment approach (Sub-Fund's applicable General Asset Class Principles in combination with its individual investment restrictions) is described in the prospectus.

● What are the binding elements of the investment strategy used to select the investments to attain each of the environmental or social characteristics promoted by this financial product?

The investment strategy adheres to the following binding elements to attain the environmental and/ or social characteristics promoted:

- Min. 80% ESG Score coverage of the Sub-Fund's Portfolio (Portfolio in this respect does not comprise derivatives and instruments that are non-evaluated by nature (e. g., cash and deposits)).
- Outperformance of benchmark in terms of weighted average ESG Score.
- Application of the following sustainable minimum exclusion criteria for direct investments:
 - securities issued by companies having a severe violation / breach of principles and guidelines such as the Principles of the United Nations Global Compact, the OECD Guidelines for Multinational Enterprises, and the United Nations Guiding Principles for Business and Human Rights on the grounds of problematic practices around human rights, labour rights, environment, and corruption,
 - securities issued by companies involved in controversial weapons (anti-personnel mines, cluster munitions, chemical weapons, biological weapons, depleted uranium, white phosphorus, and nuclear weapons),
 - securities issued by companies that derive more than 10% of their revenues from weapons, military equipment, and services,
 - securities issued by companies that derive more than 10% of their revenue from thermal coal extraction
 - securities issued by utility companies that generate more than 20% of their revenues from coal,
 - securities issued by companies involved in the production of tobacco, and securities issued by companies involved in the distribution of tobacco with more than 5% of their revenues.

Direct investments in sovereign issuers with an insufficient freedom house index score are excluded.

The sustainable minimum exclusion criteria are based on information from an external data provider and coded in pre- and post-trade compliance. The review is performed at least half yearly.

- **What is the committed minimum rate to reduce the scope of the investments considered prior to the application of that investment strategy?**

The Sub-Fund does not commit to reduce the scope of the investments by a certain minimum rate.

- **What is the policy to assess good governance practices of the investee companies?**

Good governance principles are considered by screening out companies based on their involvement in controversies around international norms corresponding to the four good governance practices: sound management structures, employee relations, remuneration of staff and tax compliance. Companies having a severe violation in either of those areas will not be investible. For certain cases, flagged issuers shall be on a watch list. These companies will appear on this watch list when the Investment Manager believes that engagement may lead to improvements or when the company is assessed to take remedial actions. Companies on the watch list remain investible unless the Investment Manager believes that the engagement or the remedial actions of the company does not lead to the desired remedy of the severe controversy.

In addition, the Sub-Fund's Investment Manager is committed to actively encourage open dialogues with investee companies on corporate governance, proxy voting and broader sustainability issues in advance of shareholder meetings (regularly for direct investments in shares). The Sub-Fund's Investment Manager's approach to proxy voting and company engagement is set out in the Management Company's Stewardship Statement.

Good governance practices include sound management structures, employee relations, remuneration of staff and tax compliance.



What is the asset allocation planned for this financial product?

Asset allocation describes the share of investments in specific assets.

Min. 80% of the Sub-Funds' assets (excluding cash, and derivatives) are used to meet the environmental or social characteristics promoted by this Sub-Fund. A low portion of the Sub-Fund might contain assets which do not promote environmental or social characteristics. Example of such instruments are derivatives, cash and deposits, some Target Funds and investment with temporarily divergent or absent environmental, social, or good governance qualifications. Min. 5% of the Sub-Funds' assets will be invested in Sustainable Investments. The Sub-Fund's Investment Manager does not commit to a minimum share of sustainable investments with an environmental objective aligned with the EU Taxonomy nor to a minimum share of environmentally Sustainable Investments that are not aligned with the EU Taxonomy. The Sub-Fund's Investment Manager does not commit to a minimum share of socially sustainable investments. While the Sub-Fund cannot commit to a minimum share of environmentally or socially sustainable investments, such investments may be freely allocated to within the Sub-Fund aggregated sustainable investment commitment disclosed (min. 5%).

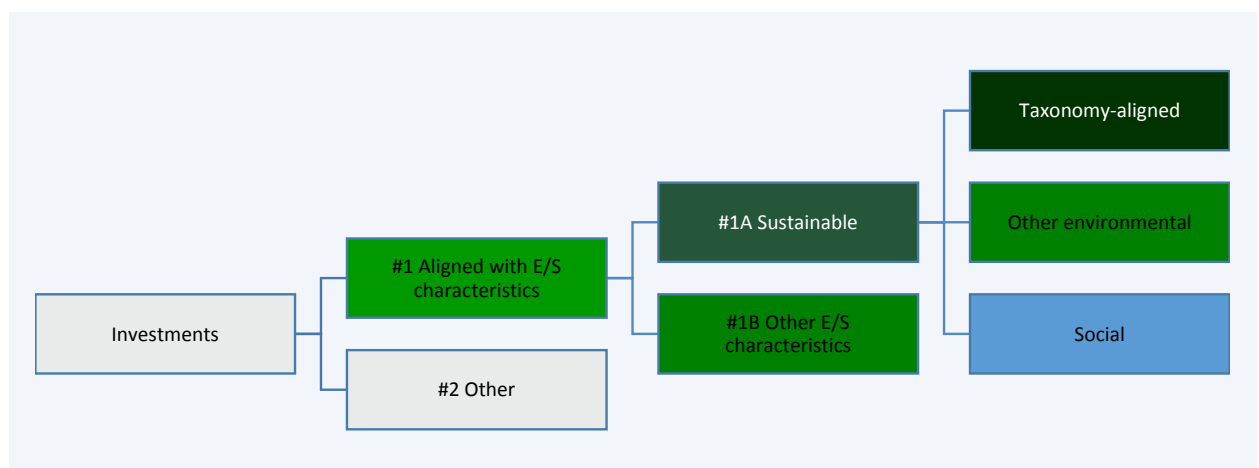

#1 Aligned with E/S characteristics includes the investments of the financial product used to attain the environmental or social characteristics promoted by the financial product.

#2 Other includes the remaining investments of the financial product which are neither aligned with the environmental or social characteristics, nor are qualified as sustainable investments.

The category **#1 Aligned with E/S characteristics** covers:

- The sub-category **#1A Sustainable** covers sustainable investments with environmental or social objectives.
- The sub-category **#1B Other E/S characteristics** covers investments aligned with the environmental or social characteristics that do not qualify as sustainable investments.

- How does the use of derivatives attain the environmental or social characteristics promoted by the financial product?

Not applicable



To what minimum extent are sustainable investments with an environmental objective aligned with the EU Taxonomy?

The Sub-Fund’s Investment Manager does not commit to a minimum share of sustainable investments with an environmental objective aligned with the EU Taxonomy. The overall sustainable investment share may also include investments with an environmental objective in economic activities that qualify as environmentally sustainable under the EU Taxonomy.

- Does the financial product invest in fossil gas and/or nuclear energy related activities that comply with the EU Taxonomy ¹?

- Yes:
 - In fossil gas
 - In nuclear energy
- No

The Sub-Fund does not pursue any investments in fossil gas and/or nuclear energy related activities that comply with the EU Taxonomy. Nevertheless, as result of this investment strategy, investments may occur in corporates which are also active in these activities. Further information will be provided as part of the annual reporting, if relevant.

The two graphs below show in green the minimum percentage of investments that are aligned with the EU Taxonomy. As there is no appropriate methodology to determine the Taxonomy-alignment of sovereign bonds*, the first graph shows the Taxonomy-alignment in relation to all the investments of the financial product including sovereign bonds, while the second graph shows the Taxonomy-alignment only in relation to the investments of the financial product other than sovereign bonds.

1. Taxonomy-alignment of investments including sovereign bonds*

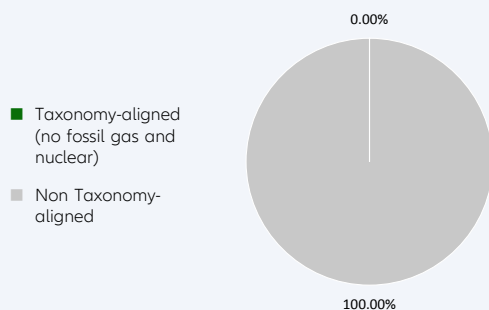

2. Taxonomy-alignment of investments excluding sovereign bonds*

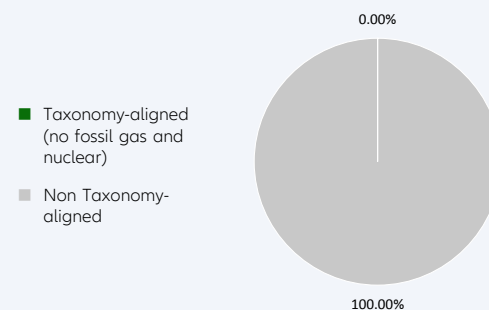

This graph represents X% of the total investments. It is noted that – due to the fact that this Sub-Fund does not provide for a minimum quota of taxonomy-aligned investments – this graph does not generate any additional added value compared to the left-hand graph.

* For the purpose of these graphs, ‘sovereign bonds’ consist of all sovereign exposures

- What is the minimum share of investments in transitional and enabling activities?

The Sub-Fund’s Investment Manager does not commit to a split of minimum taxonomy alignment into transitional, enabling activities and own performance.

Taxonomy-aligned activities are expressed as a share of:

- **turnover** reflecting the share of revenue from green activities of investee companies
- **capital expenditure** (CapEx) showing the green investments made by investee companies, e.g. for a transition to a green economy.
- **operational expenditure** (OpEx) reflecting green operational activities of investee companies.

Enabling activities directly enable other activities to make a substantial contribution to an environmental objective.

Transitional activities are activities for which low-carbon alternatives are not yet available

¹ Fossil gas and/or nuclear related activities will only comply with the EU Taxonomy where they contribute to limiting climate change (“climate change mitigation”) and do not significantly harm any EU Taxonomy objective - see explanatory note in the left hand margin. The full criteria for fossil gas and nuclear energy economic activities that comply with the EU Taxonomy are laid down in Commission Delegated Regulation (EU) 2022/1214.

and among others have greenhouse gas emission levels corresponding to the best performance.



What is the minimum share of sustainable investments with an environmental objective that are not aligned with the EU Taxonomy?

Taxonomy-aligned investments are considered a sub-category of Sustainable Investments. If an investment is not Taxonomy-aligned since the activity is not yet covered under the EU Taxonomy or the positive contribution is not substantial enough to comply with the Taxonomy technical screening criteria, the investment can still be considered an environmentally Sustainable Investment provided it complies with all criteria. The Investment Manager does not commit to a minimum share of environmentally Sustainable Investments that are not aligned with the EU Taxonomy. The overall sustainable investment share may also include investments with an environmental objective in economic activities that do not qualify as environmentally sustainable under the EU Taxonomy, and while the Sub-Fund cannot commit to a minimum share of environmentally or socially sustainable investments, such investments may be freely allocated to within the Sub-Fund aggregated sustainable investment commitment disclosed (min. 5%).



are sustainable investments with an environmental objective that **do not take into account the criteria** for environmentally sustainable economic activities under the EU Taxonomy.



What is the minimum share of socially sustainable investments?

The Investment Manager defines Sustainable Investments based on internal research, which uses, among others, the UN Sustainable Development Goals (SDGs), as well as the objectives of the EU Taxonomy as reference frameworks. The Investment Manager does not commit to a minimum share of socially Sustainable Investments, as the SDGs contain environmental as well as social objectives. The overall sustainable investment share may also include investments with a social objective, and while the Sub-Fund cannot commit to a minimum share of environmentally or socially sustainable investments, such investments may be freely allocated to within the Sub-Fund aggregated sustainable investment commitment disclosed (min. 5%).



What investments are included under “#2 Other”, what is their purpose and are there any minimum environmental or social safeguards?

Under “#2 Other” investments into cash, Target Funds, or derivatives can be included. Derivatives might be used for efficient portfolio management (including risk hedging) and/or investment purposes, and Target Funds to benefit from a specific strategy. For those investments no environmental or social safeguards are applied.



Is a specific index designated as a reference benchmark to determine whether this financial product is aligned with the environmental and/or social characteristics that it promotes?

Yes, the Sub-Fund has assigned the MSCI China A Total Return Net as a benchmark. This benchmark is a market index. The Sub-Fund will promote environmental and social characteristics by outperforming the benchmark's Weighted ESG Score.

Reference benchmarks are indexes to measure whether the financial product attains the environmental or social characteristics that they promote.

- **How is the reference benchmark continuously aligned with each of the environmental or social characteristics promoted by the financial product?**

The benchmark is a market index and does not incorporate environmental or social characteristics for index construction.

- **How is the alignment of the investment strategy with the methodology of the index ensured on a continuous basis?**

The benchmark is not continuously aligned as it does not incorporate environmental or social characteristics for index construction.

- **How does the designated index differ from a relevant broad market index?**

The benchmark is a broad market index.

- **Where can the methodology used for the calculation of the designated index be found?**

Details of the Benchmark's methodology may be found at <https://www.msci.com/documents/10199/b39c7f2f-21c7-4fb6-9fa3-d0a19babcf17> or at www.msci.com



Where can I find more product specific information online?

More product-specific information can be found on the website: <https://regulatory.allianzgi.com/SFDR>

Template pre-contractual disclosure for the financial products referred to in Article 8, paragraphs 1, 2 and 2a, of Regulation (EU) 2019/2088 and Article 6, first paragraph, of Regulation (EU) 2020/852

Product name:

Allianz China A-Shares

Legal entity identifier: 529900CTGGXS3O08YO05

Environmental and/or social characteristics

Sustainable investment means an investment in an economic activity that contributes to an environmental or social objective, provided that the investment does not significantly harm any environmental or social objective and that the investee companies follow good governance practices.

The **EU Taxonomy** is a classification system laid down in Regulation (EU) 2020/852, establishing a list of **environmentally sustainable economic activities**. That Regulation does not include a list of socially sustainable economic activities. Sustainable investments with an environmental objective might be aligned with the Taxonomy or not.

Does this financial product have a sustainable investment objective?	
Yes	No
<input type="checkbox"/> It will make a minimum of sustainable investments with an environmental objective : ___% <input type="checkbox"/> in economic activities that qualify as environmentally sustainable under the EU Taxonomy <input type="checkbox"/> in economic activities that do not qualify as environmentally sustainable under the EU Taxonomy	<input checked="" type="checkbox"/> It promotes Environmental/Social (E/S) characteristics and while it does not have as its objective a sustainable investment, it will have a minimum proportion of 5.00% of sustainable investments <input checked="" type="checkbox"/> with an environmental objective in economic activities that qualify as environmentally sustainable under the EU Taxonomy <input checked="" type="checkbox"/> with an environmental objective in economic activities that do not qualify as environmentally sustainable under the EU Taxonomy <input checked="" type="checkbox"/> with a social objective
<input type="checkbox"/> It will make a minimum of sustainable investments with a social objective ___%	<input type="checkbox"/> It promotes E/S characteristics, but will not make any sustainable investments



What environmental and/or social characteristics are promoted by this financial product?

Allianz China A-Shares (the "Sub-Fund") promotes Environment, Social and Governance factors through the ESG Score Strategy. The ESG Score Strategy aims to measure a company's resilience to long-term risks across the three pillars of Environment, Social and Governance. ESG pillars will be addressed by outperforming the Weighted Average ESG Score of issuers whose shares have been acquired by the Sub-Fund against the Weighted Average ESG Score of issuers which are components of Sub-Fund's benchmark.

In addition, sustainable minimum exclusion criteria apply.

A reference benchmark has been designated for the purpose of attaining the environmental or social characteristics promoted by the Sub-Fund.

● What sustainability indicators are used to measure the attainment of each of the environmental or social characteristics promoted by this financial product?

To measure the attainment of the environmental and/or social characteristics the following sustainability indicators are used and reported on, at the fiscal year end:

- The actual percentage of ESG Score coverage of the Sub-Fund's Portfolio (Portfolio in this respect does not comprise derivatives and instruments that are non-evaluated by nature (e. g., cash and deposits)).
- The weighted average ESG Score of the portfolio vs the weighted average ESG Score of the benchmark.

Sustainability indicators measure how the environmental or social characteristics promoted by the financial product are attained.

- Confirmation that Principal Adverse Impacts (PAIs) of investment decisions on sustainability factors are considered through the application of exclusion criteria.

- **What are the objectives of the sustainable investments that the financial product partially intends to make and how does the sustainable investment contribute to such objectives?**

Sustainable investments contribute to environmental and/or social objectives, for which the Investment Manager uses as reference frameworks, among others, the UN Sustainable Development Goals (SDGs), as well as the objectives of the EU Taxonomy:

1. Climate Change Mitigation
2. Climate Change Adaptation
3. Sustainable Use and Protection of Water and Marine Resources
4. Transition to a Circular Economy
5. Pollution Prevention and Control
6. Protection and Restoration of Biodiversity and Ecosystems

The assessment of the positive contribution to the environmental or social objectives is based on a proprietary framework which combines quantitative elements with qualitative inputs from internal research. The methodology applies first a quantitative breakdown of a securities issuer into its business activities. The qualitative element of the framework is an assessment if business activities contribute positively to an environmental or a social objective.

To calculate the positive contribution on the Sub-Fund level the revenue share of each issuer attributable to business activities contributing to environmental and/or social objectives is considered provided the issuer is satisfying the Do No Significant Harm (“DNSH”) and Good Governance principles, and an asset-weighted aggregation is performed as a second step. Moreover, for certain types of securities, which finance specific projects contributing to environmental or social objectives the overall investment is considered to contribute to environmental and/or social objectives, but also for these a DNSH as well as a Good Governance check for issuers is performed.

- **How do the sustainable investments that the financial product partially intends to make, not cause significant harm to any environmental or social sustainable investment objective?**

In order to ensure that Sustainable Investments do not significantly harm any other environmental and/or social objective, the Investment Manager is leveraging the PAI indicators, whereby significance thresholds have been defined to identify significantly harmful issuers. Issuers not meeting the significance threshold can be engaged for a limited time period to remediate the adverse impact. Otherwise, if the issuer does not meet the defined significance thresholds twice subsequently or in case of a failed engagement, it does not pass the DNSH assessment. Investments in securities of issuers which do not pass the DNSH assessment are not counted as sustainable investments.

- *How have the indicators for adverse impacts on sustainability factors been taken into account?*

All mandatory PAI indicators are considered either as part of the application of the exclusion criteria or through thresholds on a sectorial or absolute basis. Significance thresholds have been defined and they refer to qualitative or quantitative criteria.

Recognizing the lack of data coverage for some of the PAI indicators equivalent data points are used to assess PAI indicators when applying the DNSH assessment, when relevant, for the following indicators for corporates: share of non-renewable energy consumption and production, activities negatively affecting biodiversity-sensitive areas, emissions to water, lack of processes and compliance mechanisms to monitor compliance with UNGC principles and OECD Guidelines for Multinational Enterprises; for sovereigns: GHG Intensity and investee countries subject to social violations. In case of securities which finance specific projects contributing to environmental or social objectives equivalent data at project level might be used to ensure that Sustainable Investments do not significantly harm any other environmental and/or social objective. The Investment Manager will strive to increase data coverage for PAI indicators with low data coverage by engaging with issuers and data providers. The Investment Manager will regularly evaluate whether the availability of data has increased sufficiently to potentially include assessment of such data in the investment process.

Principal adverse impacts are the most significant negative impacts of investment decisions on sustainability factors relating to environmental, social and employee matters, respect for human rights, anti-corruption and anti-bribery matters.

- *How are the sustainable investments aligned with the OECD Guidelines for Multinational Enterprises and the UN Guiding Principles on Business and Human Rights? Details:*

The Investment Manager's sustainable minimum exclusion list screens out companies based on their involvement in controversial practices against international norms. The core normative framework consists of the Principles of the UN Global Compact, the OECD Guidelines for Multinational Enterprises and the UN Guiding Principles for Business and Human Rights. Securities issued by companies having a severe violation of these frameworks will be restricted from the investment universe.

The EU Taxonomy sets out a "do not significant harm" principle by which Taxonomy-aligned investments should not significantly harm EU Taxonomy objectives and is accompanied by specific EU criteria.

The "do not significant harm" principle applies only to those investments underlying the financial product that take into account the EU criteria for environmentally sustainable economic activities. The investments underlying the remaining portion of this financial product do not take into account the EU criteria for environmentally sustainable economic activities.

Any other sustainable investments must also not significantly harm any environmental or social objectives.



Does this financial product consider principal adverse impacts on sustainability factors?

Yes

No

The Management Company has joined the Net Zero Asset Manager Initiative and considers PAI indicators through stewardship including engagement, both are relevant to mitigate potential adverse impact as a company.

Due to the commitment to the Net Zero Asset Manager Initiative, the Management Company aims to reduce greenhouse gas emissions in partnership with asset owner clients on decarbonisation goals, consistent with an ambition to reach net zero emission by 2050 or sooner across all assets under management. As part of this objective the Management Company will set an interim target for the proportion of assets to be managed in line with the attainment of net zero emissions by 2050 or sooner.

The Sub-Fund's Investment Manager addresses PAI indicators regarding greenhouse gas emission, biodiversity, water, waste as well as social and employee matters for corporate issuers, and, where relevant, the freedom house index is applied to investments in sovereigns. PAI indicators are considered within the Investment Manager's investment process through the means of exclusions as described in the "binding elements" section of the Sub-Fund.

The data coverage for the data required for the PAI indicators is heterogenous. The data coverage related to biodiversity, water and waste is low and the related PAI indicators are considered through exclusion of securities issued by companies having a severe violation / breach of principles and guidelines such as the Principles of the United Nations Global Compact, the OECD Guidelines for Multinational Enterprises, and the United Nations Guiding Principles for Business and Human Rights on the grounds of problematic practices around human rights, labour rights, environment, and corruption issues. Therefore, the Investment Manager will strive to increase data coverage for PAI indicators with low data coverage. The Investment Manager will regularly evaluate whether the availability of data has increased sufficiently to potentially include assessment of such data in the investment process.

Additionally, PAI indicators are, among other sustainability factors, applied in the ESG Score. The ESG Score is used for the portfolio construction.

The following PAI indicators are considered:

Applicable to corporate issuers

- GHG Emissions
- Carbon footprint
- GHG Intensity of investee companies
- Exposure to companies active in the fossil fuel sector
- Activities negatively affecting biodiversity-sensitive areas
- Emissions to water
- Hazardous waste ratio

- Violation of UN Global compact principles
- Lack of processes and compliance mechanisms to monitor compliance with UN Global Compact principles
- Board gender diversity
- Exposure to controversial weapons

Applicable to sovereign and supranational issuers

- Investee countries subject to social violations

The information on the PAI indicators will be available in the end-year report of the Sub-Fund.



What investment strategy does this financial product follow?

The investment strategy guides investment decisions based on factors such as investment objectives and risk tolerance.

Allianz China A-Shares' investment objective is to invest in China A-Shares equity markets of the PRC in accordance with the ESG Score Strategy. The Sub-Fund promotes Environment, Social and Governance factors through the ESG Score Strategy. Aim of the strategy is to outperform the weighted average ESG Score against its benchmark. The outperformance is determined as the excess between the Sub-Fund's weighted average ESG Score and the Sub-Fund's benchmark weighted average ESG Score. The ESG Score is comprised of the pillars Environment, Social and Governance. The portfolio and benchmark weights are rebased such that only issuers with ESG Scores available are considered in the calculation.

The proportion of assets which do not have a ESG Score is expected to be low. Examples of instruments not having a ESG Score are cash and deposits, some Target Funds, and investments for which the ESG Score is deemed to be not appropriate and/or data is not available.

The Sub-Fund's general investment approach (Sub-Fund's applicable General Asset Class Principles in combination with its individual investment restrictions) is described in the prospectus.

● What are the binding elements of the investment strategy used to select the investments to attain each of the environmental or social characteristics promoted by this financial product?

The investment strategy adheres to the following binding elements to attain the environmental and/ or social characteristics promoted:

- Min. 80% ESG Score coverage of the Sub-Fund's Portfolio (Portfolio in this respect does not comprise derivatives and instruments that are non-evaluated by nature (e. g., cash and deposits)).
- Outperformance of benchmark in terms of weighted average ESG Score.
- Application of the following sustainable minimum exclusion criteria for direct investments:
 - securities issued by companies having a severe violation / breach of principles and guidelines such as the Principles of the United Nations Global Compact, the OECD Guidelines for Multinational Enterprises, and the United Nations Guiding Principles for Business and Human Rights on the grounds of problematic practices around human rights, labour rights, environment, and corruption,
 - securities issued by companies involved in controversial weapons (anti-personnel mines, cluster munitions, chemical weapons, biological weapons, depleted uranium, white phosphorus, and nuclear weapons),
 - securities issued by companies that derive more than 10% of their revenues from weapons, military equipment, and services,
 - securities issued by companies that derive more than 10% of their revenue from thermal coal extraction
 - securities issued by utility companies that generate more than 20% of their revenues from coal,
 - securities issued by companies involved in the production of tobacco, and securities issued by companies involved in the distribution of tobacco with more than 5% of their revenues.

Direct investments in sovereign issuers with an insufficient freedom house index score are excluded.

The sustainable minimum exclusion criteria are based on information from an external data provider and coded in pre- and post-trade compliance. The review is performed at least half yearly.

- **What is the committed minimum rate to reduce the scope of the investments considered prior to the application of that investment strategy?**

The Sub-Fund does not commit to reduce the scope of the investments by a certain minimum rate.

- **What is the policy to assess good governance practices of the investee companies?**

Good governance principles are considered by screening out companies based on their involvement in controversies around international norms corresponding to the four good governance practices: sound management structures, employee relations, remuneration of staff and tax compliance. Companies having a severe violation in either of those areas will not be investible. For certain cases, flagged issuers shall be on a watch list. These companies will appear on this watch list when the Investment Manager believes that engagement may lead to improvements or when the company is assessed to take remedial actions. Companies on the watch list remain investible unless the Investment Manager believes that the engagement or the remedial actions of the company does not lead to the desired remedy of the severe controversy.

In addition, the Sub-Fund’s Investment Manager is committed to actively encourage open dialogues with investee companies on corporate governance, proxy voting and broader sustainability issues in advance of shareholder meetings (regularly for direct investments in shares). The Sub-Fund’s Investment Manager’s approach to proxy voting and company engagement is set out in the Management Company’s Stewardship Statement.

Good governance practices include sound management structures, employee relations, remuneration of staff and tax compliance.



What is the asset allocation planned for this financial product?

Asset allocation describes the share of investments in specific assets.

Min. 80% of the Sub-Funds’ assets (excluding cash, and derivatives) are used to meet the environmental or social characteristics promoted by this Sub-Fund. A low portion of the Sub-Fund might contain assets which do not promote environmental or social characteristics. Example of such instruments are derivatives, cash and deposits, some Target Funds and investment with temporarily divergent or absent environmental, social, or good governance qualifications. Min. 5% of the Sub-Funds’ assets will be invested in Sustainable Investments. The Sub-Fund’s Investment Manager does not commit to a minimum share of sustainable investments with an environmental objective aligned with the EU Taxonomy nor to a minimum share of environmentally Sustainable Investments that are not aligned with the EU Taxonomy. The Sub-Fund’s Investment Manager does not commit to a minimum share of socially sustainable investments. While the Sub-Fund cannot commit to a minimum share of environmentally or socially sustainable investments, such investments may be freely allocated to within the Sub-Fund aggregated sustainable investment commitment disclosed (min. 5%).

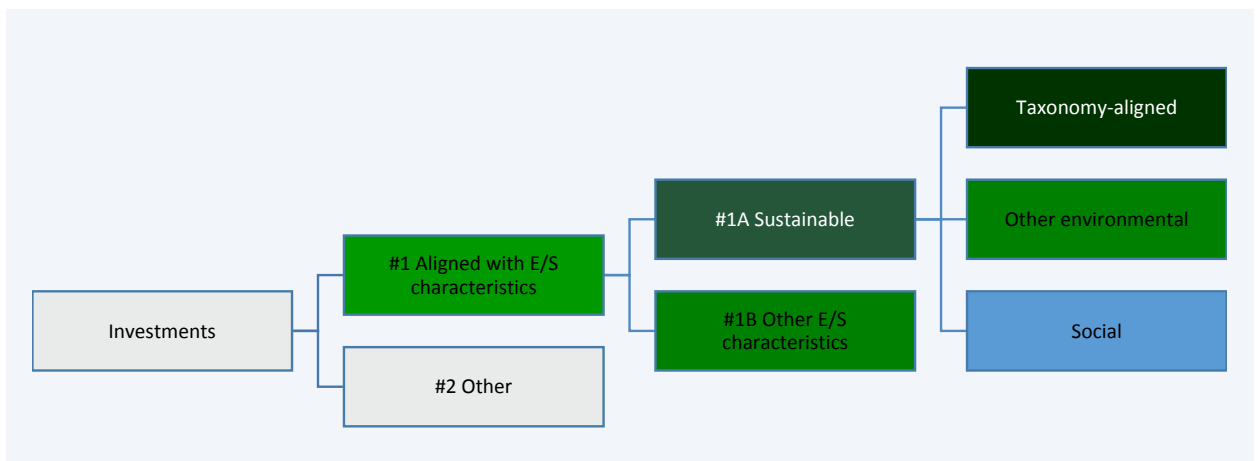

#1 Aligned with E/S characteristics includes the investments of the financial product used to attain the environmental or social characteristics promoted by the financial product.

#2 Other includes the remaining investments of the financial product which are neither aligned with the environmental or social characteristics, nor are qualified as sustainable investments.

The category **#1 Aligned with E/S characteristics** covers:

- The sub-category **#1A Sustainable** covers sustainable investments with environmental or social objectives.
- The sub-category **#1B Other E/S characteristics** covers investments aligned with the environmental or social characteristics that do not qualify as sustainable investments.

- How does the use of derivatives attain the environmental or social characteristics promoted by the financial product?

Not applicable



To what minimum extent are sustainable investments with an environmental objective aligned with the EU Taxonomy?

The Sub-Fund's Investment Manager does not commit to a minimum share of sustainable investments with an environmental objective aligned with the EU Taxonomy. The overall sustainable investment share may also include investments with an environmental objective in economic activities that qualify as environmentally sustainable under the EU Taxonomy.

- Does the financial product invest in fossil gas and/or nuclear energy related activities that comply with the EU Taxonomy¹?

- Yes:
- In fossil gas In nuclear energy
- No

The Sub-Fund does not pursue any investments in fossil gas and/or nuclear energy related activities that comply with the EU Taxonomy. Nevertheless, as result of this investment strategy, investments may occur in corporates which are also active in these activities. Further information will be provided as part of the annual reporting, if relevant.

The two graphs below show in green the minimum percentage of investments that are aligned with the EU Taxonomy. As there is no appropriate methodology to determine the Taxonomy-alignment of sovereign bonds*, the first graph shows the Taxonomy-alignment in relation to all the investments of the financial product including sovereign bonds, while the second graph shows the Taxonomy-alignment only in relation to the investments of the financial product other than sovereign bonds.

1. Taxonomy-alignment of investments including sovereign bonds*

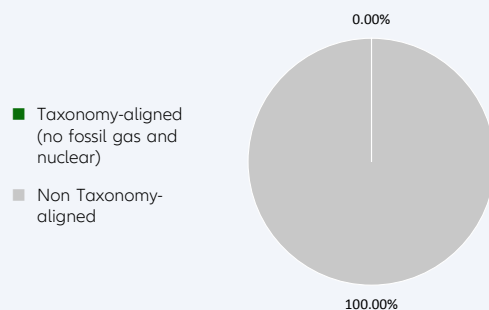

2. Taxonomy-alignment of investments excluding sovereign bonds*

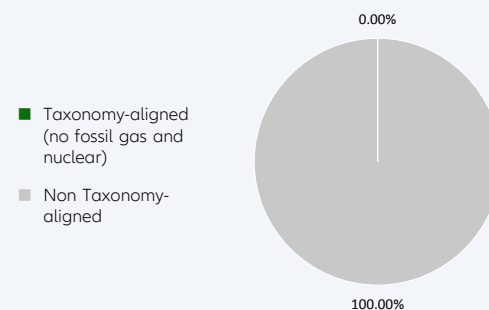

This graph represents X% of the total investments. It is noted that – due to the fact that this Sub-Fund does not provide for a minimum quota of taxonomy-aligned investments – this graph does not generate any additional added value compared to the left-hand graph.

* For the purpose of these graphs, 'sovereign bonds' consist of all sovereign exposures

- What is the minimum share of investments in transitional and enabling activities?

The Sub-Fund's Investment Manager does not commit to a split of minimum taxonomy alignment into transitional, enabling activities and own performance.

Taxonomy-aligned activities are expressed as a share of:

- **turnover** reflecting the share of revenue from green activities of investee companies
- **capital expenditure (CapEx)** showing the green investments made by investee companies, e.g. for a transition to a green economy.
- **operational expenditure (OpEx)** reflecting green operational activities of investee companies.

Enabling activities directly enable other activities to make a substantial contribution to an environmental objective.

Transitional activities are activities for which low-carbon alternatives are not yet available

¹ Fossil gas and/or nuclear related activities will only comply with the EU Taxonomy where they contribute to limiting climate change ("climate change mitigation") and do not significantly harm any EU Taxonomy objective - see explanatory note in the left hand margin. The full criteria for fossil gas and nuclear energy economic activities that comply with the EU Taxonomy are laid down in Commission Delegated Regulation (EU) 2022/1214.

and among others have greenhouse gas emission levels corresponding to the best performance.



What is the minimum share of sustainable investments with an environmental objective that are not aligned with the EU Taxonomy?

Taxonomy-aligned investments are considered a sub-category of Sustainable Investments. If an investment is not Taxonomy-aligned since the activity is not yet covered under the EU Taxonomy or the positive contribution is not substantial enough to comply with the Taxonomy technical screening criteria, the investment can still be considered an environmentally Sustainable Investment provided it complies with all criteria. The Investment Manager does not commit to a minimum share of environmentally Sustainable Investments that are not aligned with the EU Taxonomy. The overall sustainable investment share may also include investments with an environmental objective in economic activities that do not qualify as environmentally sustainable under the EU Taxonomy, and while the Sub-Fund cannot commit to a minimum share of environmentally or socially sustainable investments, such investments may be freely allocated to within the Sub-Fund aggregated sustainable investment commitment disclosed (min. 5%).



are sustainable investments with an environmental objective that **do not take into account the criteria** for environmentally sustainable economic activities under the EU Taxonomy.



What is the minimum share of socially sustainable investments?

The Investment Manager defines Sustainable Investments based on internal research, which uses, among others, the UN Sustainable Development Goals (SDGs), as well as the objectives of the EU Taxonomy as reference frameworks. The Investment Manager does not commit to a minimum share of socially Sustainable Investments, as the SDGs contain environmental as well as social objectives. The overall sustainable investment share may also include investments with a social objective, and while the Sub-Fund cannot commit to a minimum share of environmentally or socially sustainable investments, such investments may be freely allocated to within the Sub-Fund aggregated sustainable investment commitment disclosed (min. 5%).



What investments are included under “#2 Other”, what is their purpose and are there any minimum environmental or social safeguards?

Under “#2 Other” investments into cash, Target Funds, or derivatives can be included. Derivatives might be used for efficient portfolio management (including risk hedging) and/or investment purposes, and Target Funds to benefit from a specific strategy. For those investments no environmental or social safeguards are applied.



Is a specific index designated as a reference benchmark to determine whether this financial product is aligned with the environmental and/or social characteristics that it promotes?

Yes, the Sub-Fund has assigned the MSCI China A Onshore Total Return Net as a benchmark. This benchmark is a market index. The Sub-Fund will promote environmental and social characteristics by outperforming the benchmark's Weighted ESG Score.

Reference benchmarks are indexes to measure whether the financial product attains the environmental or social characteristics that they promote.

- **How is the reference benchmark continuously aligned with each of the environmental or social characteristics promoted by the financial product?**

The benchmark is a market index and does not incorporate environmental or social characteristics for index construction.

- **How is the alignment of the investment strategy with the methodology of the index ensured on a continuous basis?**

The benchmark is not continuously aligned as it does not incorporate environmental or social characteristics for index construction.

- **How does the designated index differ from a relevant broad market index?**

The benchmark is a broad market index.

- **Where can the methodology used for the calculation of the designated index be found?**

Details of the Benchmark's methodology may be found at <https://www.msci.com/documents/10199/85d8ca04-533e-d8b6-dfa7-b97589ffb12a> or at www.msci.com



Where can I find more product specific information online?

More product-specific information can be found on the website: <https://regulatory.allianzgi.com/SFDR>

Template pre-contractual disclosure for the financial products referred to in Article 8, paragraphs 1, 2 and 2a, of Regulation (EU) 2019/2088 and Article 6, first paragraph, of Regulation (EU) 2020/852

Product name:

Allianz China Equity

Legal entity identifier: 549300HFT1TW3OAGQ113

Environmental and/or social characteristics

Sustainable investment means an investment in an economic activity that contributes to an environmental or social objective, provided that the investment does not significantly harm any environmental or social objective and that the investee companies follow good governance practices.

The EU Taxonomy is a classification system laid down in Regulation (EU) 2020/852, establishing a list of **environmentally sustainable economic activities**. That Regulation does not include a list of socially sustainable economic activities. Sustainable investments with an environmental objective might be aligned with the Taxonomy or not.

Does this financial product have a sustainable investment objective?

Yes

No

It will make a minimum of **sustainable investments with an environmental objective**: ___%

in economic activities that qualify as environmentally sustainable under the EU Taxonomy

in economic activities that do not qualify as environmentally sustainable under the EU Taxonomy

It will make a minimum of **sustainable investments with a social objective** ___%

It promotes **Environmental/Social (E/S) characteristics** and while it does not have as its objective a sustainable investment, it will have a minimum proportion of **2.00%** of sustainable investments

with an environmental objective in economic activities that qualify as environmentally sustainable under the EU Taxonomy

with an environmental objective in economic activities that do not qualify as environmentally sustainable under the EU Taxonomy

with a social objective

It promotes E/S characteristics, but **will not make any sustainable investments**



What environmental and/or social characteristics are promoted by this financial product?

Allianz China Equity (the "Sub-Fund") promotes Environment, Social and Governance factors through the ESG Score Strategy. The ESG Score Strategy aims to measure a company's resilience to long-term risks across the three pillars of Environment, Social and Governance. ESG pillars will be addressed by outperforming the Weighted Average ESG Score of issuers whose shares have been acquired by the Sub-Fund against the Weighted Average ESG Score of issuers which are components of Sub-Fund's benchmark.

In addition, sustainable minimum exclusion criteria apply.

A reference benchmark has been designated for the purpose of attaining the environmental or social characteristics promoted by the Sub-Fund.

● What sustainability indicators are used to measure the attainment of each of the environmental or social characteristics promoted by this financial product?

To measure the attainment of the environmental and/or social characteristics the following sustainability indicators are used and reported on, at the fiscal year end:

- The actual percentage of ESG Score coverage of the Sub-Fund's Portfolio (Portfolio in this respect does not comprise derivatives and instruments that are non-evaluated by nature (e. g., cash and deposits)).
- The weighted average ESG Score of the portfolio vs the weighted average ESG Score of the benchmark.

Sustainability indicators measure how the environmental or social characteristics promoted by the financial product are attained.

- Confirmation that Principal Adverse Impacts (PAIs) of investment decisions on sustainability factors are considered through the application of exclusion criteria.

- **What are the objectives of the sustainable investments that the financial product partially intends to make and how does the sustainable investment contribute to such objectives?**

Sustainable investments contribute to environmental and/or social objectives, for which the Investment Manager uses as reference frameworks, among others, the UN Sustainable Development Goals (SDGs), as well as the objectives of the EU Taxonomy:

1. Climate Change Mitigation
2. Climate Change Adaptation
3. Sustainable Use and Protection of Water and Marine Resources
4. Transition to a Circular Economy
5. Pollution Prevention and Control
6. Protection and Restoration of Biodiversity and Ecosystems

The assessment of the positive contribution to the environmental or social objectives is based on a proprietary framework which combines quantitative elements with qualitative inputs from internal research. The methodology applies first a quantitative breakdown of a securities issuer into its business activities. The qualitative element of the framework is an assessment if business activities contribute positively to an environmental or a social objective.

To calculate the positive contribution on the Sub-Fund level the revenue share of each issuer attributable to business activities contributing to environmental and/or social objectives is considered provided the issuer is satisfying the Do No Significant Harm (“DNSH”) and Good Governance principles, and an asset-weighted aggregation is performed as a second step. Moreover, for certain types of securities, which finance specific projects contributing to environmental or social objectives the overall investment is considered to contribute to environmental and/or social objectives, but also for these a DNSH as well as a Good Governance check for issuers is performed.

- **How do the sustainable investments that the financial product partially intends to make, not cause significant harm to any environmental or social sustainable investment objective?**

In order to ensure that Sustainable Investments do not significantly harm any other environmental and/or social objective, the Investment Manager is leveraging the PAI indicators, whereby significance thresholds have been defined to identify significantly harmful issuers. Issuers not meeting the significance threshold can be engaged for a limited time period to remediate the adverse impact. Otherwise, if the issuer does not meet the defined significance thresholds twice subsequently or in case of a failed engagement, it does not pass the DNSH assessment. Investments in securities of issuers which do not pass the DNSH assessment are not counted as sustainable investments.

- *How have the indicators for adverse impacts on sustainability factors been taken into account?*

All mandatory PAI indicators are considered either as part of the application of the exclusion criteria or through thresholds on a sectorial or absolute basis. Significance thresholds have been defined and they refer to qualitative or quantitative criteria.

Recognizing the lack of data coverage for some of the PAI indicators equivalent data points are used to assess PAI indicators when applying the DNSH assessment, when relevant, for the following indicators for corporates: share of non-renewable energy consumption and production, activities negatively affecting biodiversity-sensitive areas, emissions to water, lack of processes and compliance mechanisms to monitor compliance with UNGC principles and OECD Guidelines for Multinational Enterprises; for sovereigns: GHG Intensity and investee countries subject to social violations. In case of securities which finance specific projects contributing to environmental or social objectives equivalent data at project level might be used to ensure that Sustainable Investments do not significantly harm any other environmental and/or social objective. The Investment Manager will strive to increase data coverage for PAI indicators with low data coverage by engaging with issuers and data providers. The Investment Manager will regularly evaluate whether the availability of data has increased sufficiently to potentially include assessment of such data in the investment process.

Principal adverse impacts are the most significant negative impacts of investment decisions on sustainability factors relating to environmental, social and employee matters, respect for human rights, anti-corruption and anti-bribery matters.

- *How are the sustainable investments aligned with the OECD Guidelines for Multinational Enterprises and the UN Guiding Principles on Business and Human Rights? Details:*

The Investment Manager's sustainable minimum exclusion list screens out companies based on their involvement in controversial practices against international norms. The core normative framework consists of the Principles of the UN Global Compact, the OECD Guidelines for Multinational Enterprises and the UN Guiding Principles for Business and Human Rights. Securities issued by companies having a severe violation of these frameworks will be restricted from the investment universe.

The EU Taxonomy sets out a "do not significant harm" principle by which Taxonomy-aligned investments should not significantly harm EU Taxonomy objectives and is accompanied by specific EU criteria.

The "do not significant harm" principle applies only to those investments underlying the financial product that take into account the EU criteria for environmentally sustainable economic activities. The investments underlying the remaining portion of this financial product do not take into account the EU criteria for environmentally sustainable economic activities.

Any other sustainable investments must also not significantly harm any environmental or social objectives.



Does this financial product consider principal adverse impacts on sustainability factors?

Yes

No

The Management Company has joined the Net Zero Asset Manager Initiative and considers PAI indicators through stewardship including engagement, both are relevant to mitigate potential adverse impact as a company.

Due to the commitment to the Net Zero Asset Manager Initiative, the Management Company aims to reduce greenhouse gas emissions in partnership with asset owner clients on decarbonisation goals, consistent with an ambition to reach net zero emission by 2050 or sooner across all assets under management. As part of this objective the Management Company will set an interim target for the proportion of assets to be managed in line with the attainment of net zero emissions by 2050 or sooner.

The Sub-Fund's Investment Manager addresses PAI indicators regarding greenhouse gas emission, biodiversity, water, waste as well as social and employee matters for corporate issuers, and, where relevant, the freedom house index is applied to investments in sovereigns. PAI indicators are considered within the Investment Manager's investment process through the means of exclusions as described in the "binding elements" section of the Sub-Fund.

The data coverage for the data required for the PAI indicators is heterogenous. The data coverage related to biodiversity, water and waste is low and the related PAI indicators are considered through exclusion of securities issued by companies having a severe violation / breach of principles and guidelines such as the Principles of the United Nations Global Compact, the OECD Guidelines for Multinational Enterprises, and the United Nations Guiding Principles for Business and Human Rights on the grounds of problematic practices around human rights, labour rights, environment, and corruption issues. Therefore, the Investment Manager will strive to increase data coverage for PAI indicators with low data coverage. The Investment Manager will regularly evaluate whether the availability of data has increased sufficiently to potentially include assessment of such data in the investment process.

Additionally, PAI indicators are, among other sustainability factors, applied in the ESG Score. The ESG Score is used for the portfolio construction.

The following PAI indicators are considered:

Applicable to corporate issuers

- GHG Emissions
- Carbon footprint
- GHG Intensity of investee companies
- Exposure to companies active in the fossil fuel sector
- Activities negatively affecting biodiversity-sensitive areas
- Emissions to water
- Hazardous waste ratio

- Violation of UN Global compact principles
- Lack of processes and compliance mechanisms to monitor compliance with UN Global Compact principles
- Board gender diversity
- Exposure to controversial weapons

Applicable to sovereign and supranational issuers

- Investee countries subject to social violations

The information on the PAI indicators will be available in the end-year report of the Sub-Fund.



What investment strategy does this financial product follow?

The investment strategy guides investment decisions based on factors such as investment objectives and risk tolerance.

Allianz China Equity's investment objective is to invest in the Equity Markets of the PRC, Hong Kong and Macau in accordance with the ESG Score Strategy. The Sub-Fund promotes Environment, Social and Governance factors through the ESG Score Strategy. Aim of the strategy is to outperform the weighted average ESG Score against its benchmark. The outperformance is determined as the excess between the Sub-Fund's weighted average ESG Score and the Sub-Fund's benchmark weighted average ESG Score. The ESG Score is comprised of the pillars Environment, Social and Governance. The portfolio and benchmark weights are rebased such that only issuers with ESG Scores available are considered in the calculation.

The proportion of assets which do not have a ESG Score is expected to be low. Examples of instruments not having a ESG Score are cash and deposits, some Target Funds, and investments for which the ESG Score is deemed to be not appropriate and/or data is not available.

The Sub-Fund's general investment approach (Sub-Fund's applicable General Asset Class Principles in combination with its individual investment restrictions) is described in the prospectus.

● What are the binding elements of the investment strategy used to select the investments to attain each of the environmental or social characteristics promoted by this financial product?

The investment strategy adheres to the following binding elements to attain the environmental and/ or social characteristics promoted:

- Min. 80% ESG Score coverage of the Sub-Fund's Portfolio (Portfolio in this respect does not comprise derivatives and instruments that are non-evaluated by nature (e. g., cash and deposits)).
- Outperformance of benchmark in terms of weighted average ESG Score.
- Application of the following sustainable minimum exclusion criteria for direct investments:
 - securities issued by companies having a severe violation / breach of principles and guidelines such as the Principles of the United Nations Global Compact, the OECD Guidelines for Multinational Enterprises, and the United Nations Guiding Principles for Business and Human Rights on the grounds of problematic practices around human rights, labour rights, environment, and corruption,
 - securities issued by companies involved in controversial weapons (anti-personnel mines, cluster munitions, chemical weapons, biological weapons, depleted uranium, white phosphorus, and nuclear weapons),
 - securities issued by companies that derive more than 10% of their revenues from weapons, military equipment, and services,
 - securities issued by companies that derive more than 10% of their revenue from thermal coal extraction
 - securities issued by utility companies that generate more than 20% of their revenues from coal,
 - securities issued by companies involved in the production of tobacco, and securities issued by companies involved in the distribution of tobacco with more than 5% of their revenues.

Direct investments in sovereign issuers with an insufficient freedom house index score are excluded.

The sustainable minimum exclusion criteria are based on information from an external data provider and coded in pre- and post-trade compliance. The review is performed at least half yearly.

- **What is the committed minimum rate to reduce the scope of the investments considered prior to the application of that investment strategy?**

The Sub-Fund does not commit to reduce the scope of the investments by a certain minimum rate.

- **What is the policy to assess good governance practices of the investee companies?**

Good governance principles are considered by screening out companies based on their involvement in controversies around international norms corresponding to the four good governance practices: sound management structures, employee relations, remuneration of staff and tax compliance. Companies having a severe violation in either of those areas will not be investible. For certain cases, flagged issuers shall be on a watch list. These companies will appear on this watch list when the Investment Manager believes that engagement may lead to improvements or when the company is assessed to take remedial actions. Companies on the watch list remain investible unless the Investment Manager believes that the engagement or the remedial actions of the company does not lead to the desired remedy of the severe controversy.

In addition, the Sub-Fund's Investment Manager is committed to actively encourage open dialogues with investee companies on corporate governance, proxy voting and broader sustainability issues in advance of shareholder meetings (regularly for direct investments in shares). The Sub-Fund's Investment Manager's approach to proxy voting and company engagement is set out in the Management Company's Stewardship Statement.

Good governance practices include sound management structures, employee relations, remuneration of staff and tax compliance.



What is the asset allocation planned for this financial product?

Asset allocation describes the share of investments in specific assets.

Min. 80% of the Sub-Funds' assets (excluding cash, and derivatives) are used to meet the environmental or social characteristics promoted by this Sub-Fund. A low portion of the Sub-Fund might contain assets which do not promote environmental or social characteristics. Example of such instruments are derivatives, cash and deposits, some Target Funds and investment with temporarily divergent or absent environmental, social, or good governance qualifications. Min. 2% of the Sub-Funds' assets will be invested in Sustainable Investments. The Sub-Fund's Investment Manager does not commit to a minimum share of sustainable investments with an environmental objective aligned with the EU Taxonomy nor to a minimum share of environmentally Sustainable Investments that are not aligned with the EU Taxonomy. The Sub-Fund's Investment Manager does not commit to a minimum share of socially sustainable investments. While the Sub-Fund cannot commit to a minimum share of environmentally or socially sustainable investments, such investments may be freely allocated to within the Sub-Fund aggregated sustainable investment commitment disclosed (min. 2%).

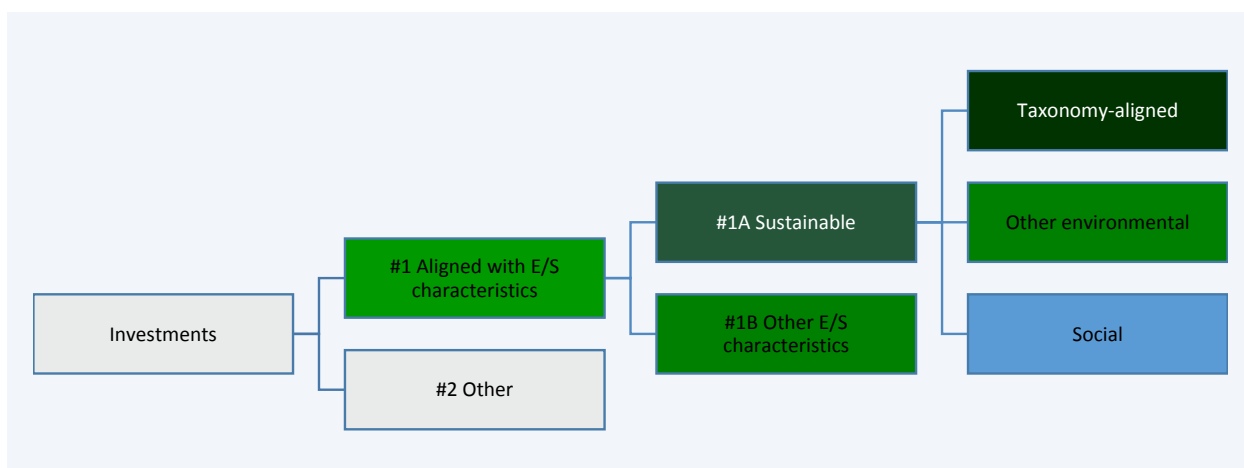

#1 Aligned with E/S characteristics includes the investments of the financial product used to attain the environmental or social characteristics promoted by the financial product.

#2 Other includes the remaining investments of the financial product which are neither aligned with the environmental or social characteristics, nor are qualified as sustainable investments.

The category **#1 Aligned with E/S characteristics** covers:

- The sub-category **#1A Sustainable** covers sustainable investments with environmental or social objectives.
- The sub-category **#1B Other E/S characteristics** covers investments aligned with the environmental or social characteristics that do not qualify as sustainable investments.

- How does the use of derivatives attain the environmental or social characteristics promoted by the financial product?

Not applicable



To what minimum extent are sustainable investments with an environmental objective aligned with the EU Taxonomy?

The Sub-Fund's Investment Manager does not commit to a minimum share of sustainable investments with an environmental objective aligned with the EU Taxonomy. The overall sustainable investment share may also include investments with an environmental objective in economic activities that qualify as environmentally sustainable under the EU Taxonomy.

- Does the financial product invest in fossil gas and/or nuclear energy related activities that comply with the EU Taxonomy ¹?

- Yes:
- In fossil gas
 - In nuclear energy
- No

The Sub-Fund does not pursue any investments in fossil gas and/or nuclear energy related activities that comply with the EU Taxonomy. Nevertheless, as result of this investment strategy, investments may occur in corporates which are also active in these activities. Further information will be provided as part of the annual reporting, if relevant.

The two graphs below show in green the minimum percentage of investments that are aligned with the EU Taxonomy. As there is no appropriate methodology to determine the Taxonomy-alignment of sovereign bonds*, the first graph shows the Taxonomy-alignment in relation to all the investments of the financial product including sovereign bonds, while the second graph shows the Taxonomy-alignment only in relation to the investments of the financial product other than sovereign bonds.

1. Taxonomy-alignment of investments including sovereign bonds*

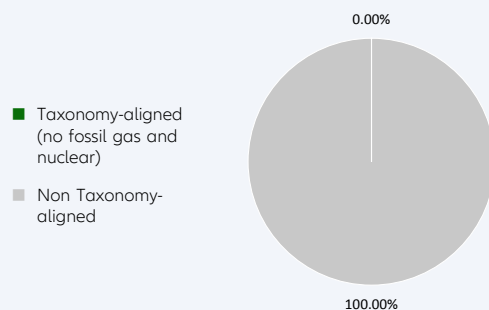

2. Taxonomy-alignment of investments excluding sovereign bonds*

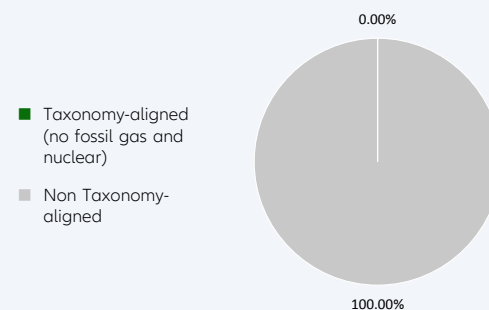

This graph represents X% of the total investments. It is noted that – due to the fact that this Sub-Fund does not provide for a minimum quota of taxonomy-aligned investments – this graph does not generate any additional added value compared to the left-hand graph.

* For the purpose of these graphs, 'sovereign bonds' consist of all sovereign exposures

- What is the minimum share of investments in transitional and enabling activities?

The Sub-Fund's Investment Manager does not commit to a split of minimum taxonomy alignment into transitional, enabling activities and own performance.

Taxonomy-aligned activities are expressed as a share of:

- **turnover** reflecting the share of revenue from green activities of investee companies
- **capital expenditure** (CapEx) showing the green investments made by investee companies, e.g. for a transition to a green economy.
- **operational expenditure** (OpEx) reflecting green operational activities of investee companies.

Enabling activities directly enable other activities to make a substantial contribution to an environmental objective.

Transitional activities are activities for which low-carbon alternatives are not yet available

¹ Fossil gas and/or nuclear related activities will only comply with the EU Taxonomy where they contribute to limiting climate change ("climate change mitigation") and do not significantly harm any EU Taxonomy objective - see explanatory note in the left hand margin. The full criteria for fossil gas and nuclear energy economic activities that comply with the EU Taxonomy are laid down in Commission Delegated Regulation (EU) 2022/1214.

and among others have greenhouse gas emission levels corresponding to the best performance.



What is the minimum share of sustainable investments with an environmental objective that are not aligned with the EU Taxonomy?

Taxonomy-aligned investments are considered a sub-category of Sustainable Investments. If an investment is not Taxonomy-aligned since the activity is not yet covered under the EU Taxonomy or the positive contribution is not substantial enough to comply with the Taxonomy technical screening criteria, the investment can still be considered an environmentally Sustainable Investment provided it complies with all criteria. The Investment Manager does not commit to a minimum share of environmentally Sustainable Investments that are not aligned with the EU Taxonomy. The overall sustainable investment share may also include investments with an environmental objective in economic activities that do not qualify as environmentally sustainable under the EU Taxonomy, and while the Sub-Fund cannot commit to a minimum share of environmentally or socially sustainable investments, such investments may be freely allocated to within the Sub-Fund aggregated sustainable investment commitment disclosed (min. 2%).



are sustainable investments with an environmental objective that **do not take into account the criteria** for environmentally sustainable economic activities under the EU Taxonomy.



What is the minimum share of socially sustainable investments?

The Investment Manager defines Sustainable Investments based on internal research, which uses, among others, the UN Sustainable Development Goals (SDGs), as well as the objectives of the EU Taxonomy as reference frameworks. The Investment Manager does not commit to a minimum share of socially Sustainable Investments, as the SDGs contain environmental as well as social objectives. The overall sustainable investment share may also include investments with a social objective, and while the Sub-Fund cannot commit to a minimum share of environmentally or socially sustainable investments, such investments may be freely allocated to within the Sub-Fund aggregated sustainable investment commitment disclosed (min. 2%).



What investments are included under “#2 Other”, what is their purpose and are there any minimum environmental or social safeguards?

Under “#2 Other” investments into cash, Target Funds, or derivatives can be included. Derivatives might be used for efficient portfolio management (including risk hedging) and/or investment purposes, and Target Funds to benefit from a specific strategy. For those investments no environmental or social safeguards are applied.



Is a specific index designated as a reference benchmark to determine whether this financial product is aligned with the environmental and/or social characteristics that it promotes?

Yes, the Sub-Fund has assigned the MSCI China 10/40 Total Return Net as a benchmark. This benchmark is a market index. The Sub-Fund will promote environmental and social characteristics by outperforming the benchmark's Weighted ESG Score.

Reference benchmarks are indexes to measure whether the financial product attains the environmental or social characteristics that they promote.

- **How is the reference benchmark continuously aligned with each of the environmental or social characteristics promoted by the financial product?**

The benchmark is a market index and does not incorporate environmental or social characteristics for index construction.

- **How is the alignment of the investment strategy with the methodology of the index ensured on a continuous basis?**

The benchmark is not continuously aligned as it does not incorporate environmental or social characteristics for index construction.

- **How does the designated index differ from a relevant broad market index?**

The benchmark is a broad market index.

- **Where can the methodology used for the calculation of the designated index be found?**

Details of the Benchmark's methodology may be found at <https://www.msci.com/documents/10199/99fc47ae-0b1f-fcf5-47b6-91b3abfa8679> or at www.msci.com



Where can I find more product specific information online?

More product-specific information can be found on the website: <https://regulatory.allianzgi.com/SFDR>

Template pre-contractual disclosure for the financial products referred to in Article 8, paragraphs 1, 2 and 2a, of Regulation (EU) 2019/2088 and Article 6, first paragraph, of Regulation (EU) 2020/852

Product name:

Allianz China Thematica

Legal entity identifier: 529900V83BCU6OSSPK65

Environmental and/or social characteristics

Sustainable investment means an investment in an economic activity that contributes to an environmental or social objective, provided that the investment does not significantly harm any environmental or social objective and that the investee companies follow good governance practices.

The **EU Taxonomy** is a classification system laid down in Regulation (EU) 2020/852, establishing a list of **environmentally sustainable economic activities**. That Regulation does not include a list of socially sustainable economic activities. Sustainable investments with an environmental objective might be aligned with the Taxonomy or not.

Does this financial product have a sustainable investment objective?	
Yes	No
<input type="checkbox"/> It will make a minimum of sustainable investments with an environmental objective: ___% <ul style="list-style-type: none"> <input type="checkbox"/> in economic activities that qualify as environmentally sustainable under the EU Taxonomy <input type="checkbox"/> in economic activities that do not qualify as environmentally sustainable under the EU Taxonomy 	<input checked="" type="checkbox"/> It promotes Environmental/Social (E/S) characteristics and while it does not have as its objective a sustainable investment, it will have a minimum proportion of 5.00% of sustainable investments <ul style="list-style-type: none"> <input checked="" type="checkbox"/> with an environmental objective in economic activities that qualify as environmentally sustainable under the EU Taxonomy <input checked="" type="checkbox"/> with an environmental objective in economic activities that do not qualify as environmentally sustainable under the EU Taxonomy <input checked="" type="checkbox"/> with a social objective
<input type="checkbox"/> It will make a minimum of sustainable investments with a social objective ___%	<input type="checkbox"/> It promotes E/S characteristics, but will not make any sustainable investments



What environmental and/or social characteristics are promoted by this financial product?

Allianz China Thematica (the "Sub-Fund") promotes Environment, Social and Governance factors through the ESG Score Strategy. The ESG Score Strategy aims to measure a company's resilience to long-term risks across the three pillars of Environment, Social and Governance. ESG pillars will be addressed by outperforming the Weighted Average ESG Score of issuers whose shares have been acquired by the Sub-Fund against the Weighted Average ESG Score of issuers which are components of Sub-Fund's benchmark.

In addition, sustainable minimum exclusion criteria apply.

A reference benchmark has been designated for the purpose of attaining the environmental or social characteristics promoted by the Sub-Fund.

● What sustainability indicators are used to measure the attainment of each of the environmental or social characteristics promoted by this financial product?

To measure the attainment of the environmental and/or social characteristics the following sustainability indicators are used and reported on, at the fiscal year end:

- The actual percentage of ESG Score coverage of the Sub-Fund's Portfolio (Portfolio in this respect does not comprise derivatives and instruments that are non-evaluated by nature (e. g., cash and deposits)).
- The weighted average ESG Score of the portfolio vs the weighted average ESG Score of the benchmark

Sustainability indicators measure how the environmental or social characteristics promoted by the financial product are attained.

- Confirmation that Principal Adverse Impacts (PAIs) of investment decisions on sustainability factors are considered through the application of exclusion criteria.

- **What are the objectives of the sustainable investments that the financial product partially intends to make and how does the sustainable investment contribute to such objectives?**

Sustainable investments contribute to environmental and/or social objectives, for which the Investment Manager uses as reference frameworks, among others, the UN Sustainable Development Goals (SDGs), as well as the objectives of the EU Taxonomy:

1. Climate Change Mitigation
2. Climate Change Adaptation
3. Sustainable Use and Protection of Water and Marine Resources
4. Transition to a Circular Economy
5. Pollution Prevention and Control
6. Protection and Restoration of Biodiversity and Ecosystems

The assessment of the positive contribution to the environmental or social objectives is based on a proprietary framework which combines quantitative elements with qualitative inputs from internal research. The methodology applies first a quantitative breakdown of a securities issuer into its business activities. The qualitative element of the framework is an assessment if business activities contribute positively to an environmental or a social objective.

To calculate the positive contribution on the Sub-Fund level the revenue share of each issuer attributable to business activities contributing to environmental and/or social objectives is considered provided the issuer is satisfying the Do No Significant Harm (“DNSH”) and Good Governance principles, and an asset-weighted aggregation is performed as a second step. Moreover, for certain types of securities, which finance specific projects contributing to environmental or social objectives the overall investment is considered to contribute to environmental and/or social objectives, but also for these a DNSH as well as a Good Governance check for issuers is performed.

- **How do the sustainable investments that the financial product partially intends to make, not cause significant harm to any environmental or social sustainable investment objective?**

In order to ensure that Sustainable Investments do not significantly harm any other environmental and/or social objective, the Investment Manager is leveraging the PAI indicators, whereby significance thresholds have been defined to identify significantly harmful issuers. Issuers not meeting the significance threshold can be engaged for a limited time period to remediate the adverse impact. Otherwise, if the issuer does not meet the defined significance thresholds twice subsequently or in case of a failed engagement, it does not pass the DNSH assessment. Investments in securities of issuers which do not pass the DNSH assessment are not counted as sustainable investments.

- *How have the indicators for adverse impacts on sustainability factors been taken into account?*

All mandatory PAI indicators are considered either as part of the application of the exclusion criteria or through thresholds on a sectorial or absolute basis. Significance thresholds have been defined and they refer to qualitative or quantitative criteria.

Recognizing the lack of data coverage for some of the PAI indicators equivalent data points are used to assess PAI indicators when applying the DNSH assessment, when relevant, for the following indicators for corporates: share of non-renewable energy consumption and production, activities negatively affecting biodiversity-sensitive areas, emissions to water, lack of processes and compliance mechanisms to monitor compliance with UNGC principles and OECD Guidelines for Multinational Enterprises; for sovereigns: GHG Intensity and investee countries subject to social violations. In case of securities which finance specific projects contributing to environmental or social objectives equivalent data at project level might be used to ensure that Sustainable Investments do not significantly harm any other environmental and/or social objective. The Investment Manager will strive to increase data coverage for PAI indicators with low data coverage by engaging with issuers and data providers. The Investment Manager will regularly evaluate whether the availability of data has increased sufficiently to potentially include assessment of such data in the investment process.

Principal adverse impacts are the most significant negative impacts of investment decisions on sustainability factors relating to environmental, social and employee matters, respect for human rights, anti-corruption and anti-bribery matters.

- *How are the sustainable investments aligned with the OECD Guidelines for Multinational Enterprises and the UN Guiding Principles on Business and Human Rights? Details:*

The Investment Manager's sustainable minimum exclusion list screens out companies based on their involvement in controversial practices against international norms. The core normative framework consists of the Principles of the UN Global Compact, the OECD Guidelines for Multinational Enterprises and the UN Guiding Principles for Business and Human Rights. Securities issued by companies having a severe violation of these frameworks will be restricted from the investment universe.

The EU Taxonomy sets out a "do not significant harm" principle by which Taxonomy-aligned investments should not significantly harm EU Taxonomy objectives and is accompanied by specific EU criteria.

The "do not significant harm" principle applies only to those investments underlying the financial product that take into account the EU criteria for environmentally sustainable economic activities. The investments underlying the remaining portion of this financial product do not take into account the EU criteria for environmentally sustainable economic activities.

Any other sustainable investments must also not significantly harm any environmental or social objectives.



Does this financial product consider principal adverse impacts on sustainability factors?

Yes

No

The Management Company has joined the Net Zero Asset Manager Initiative and considers PAI indicators through stewardship including engagement, both are relevant to mitigate potential adverse impact as a company.

Due to the commitment to the Net Zero Asset Manager Initiative, the Management Company aims to reduce greenhouse gas emissions in partnership with asset owner clients on decarbonisation goals, consistent with an ambition to reach net zero emission by 2050 or sooner across all assets under management. As part of this objective the Management Company will set an interim target for the proportion of assets to be managed in line with the attainment of net zero emissions by 2050 or sooner.

The Sub-Fund's Investment Manager addresses PAI indicators regarding greenhouse gas emission, biodiversity, water, waste as well as social and employee matters for corporate issuers, and, where relevant, the freedom house index is applied to investments in sovereigns. PAI indicators are considered within the Investment Manager's investment process through the means of exclusions as described in the "binding elements" section of the Sub-Fund.

The data coverage for the data required for the PAI indicators is heterogenous. The data coverage related to biodiversity, water and waste is low and the related PAI indicators are considered through exclusion of securities issued by companies having a severe violation / breach of principles and guidelines such as the Principles of the United Nations Global Compact, the OECD Guidelines for Multinational Enterprises, and the United Nations Guiding Principles for Business and Human Rights on the grounds of problematic practices around human rights, labour rights, environment, and corruption issues. Therefore, the Investment Manager will strive to increase data coverage for PAI indicators with low data coverage. The Investment Manager will regularly evaluate whether the availability of data has increased sufficiently to potentially include assessment of such data in the investment process.

Additionally, PAI indicators are, among other sustainability factors, applied in the ESG Score. The ESG Score is used for the portfolio construction.

The following PAI indicators are considered:

Applicable to corporate issuers

- GHG Emissions
- Carbon footprint
- GHG Intensity of investee companies
- Exposure to companies active in the fossil fuel sector
- Activities negatively affecting biodiversity-sensitive areas
- Emissions to water
- Hazardous waste ratio

- Violation of UN Global compact principles
- Lack of processes and compliance mechanisms to monitor compliance with UN Global Compact principles
- Board gender diversity
- Exposure to controversial weapons

Applicable to sovereign and supranational issuers

- Investee countries subject to social violations

The information on the PAI indicators will be available in the end-year report of the Sub-Fund.



What investment strategy does this financial product follow?

The investment strategy guides investment decisions based on factors such as investment objectives and risk tolerance.

Allianz China Thematica's investment objective is to invest in Equity Markets of the PRC (onshore and offshore), Hong Kong and Macau with a focus on companies whose business benefits or will benefit from growth opportunities of the PRC in accordance with the ESG Score Strategy. The Sub-Fund promotes Environment, Social and Governance factors through the ESG Score Strategy. Aim of the strategy is to outperform the weighted average ESG Score against its benchmark. The outperformance is determined as the excess between the Sub-Fund's weighted average ESG Score and the Sub-Fund's benchmark weighted average ESG Score. The ESG Score is comprised of the pillars Environment, Social and Governance. The portfolio and benchmark weights are rebased such that only issuers with ESG Scores available are considered in the calculation.

The proportion of assets which do not have a ESG Score is expected to be low. Examples of instruments not having a ESG Score are cash and deposits, some Target Funds, and investments for which the ESG Score is deemed to be not appropriate and/or data is not available.

The Sub-Fund's general investment approach (Sub-Fund's applicable General Asset Class Principles in combination with its individual investment restrictions) is described in the prospectus.

● What are the binding elements of the investment strategy used to select the investments to attain each of the environmental or social characteristics promoted by this financial product?

The investment strategy adheres to the following binding elements to attain the environmental and/ or social characteristics promoted:

- Min. 80% ESG Score coverage of the Sub-Fund's Portfolio (Portfolio in this respect does not comprise derivatives and instruments that are non-evaluated by nature (e. g., cash and deposits)).
- Outperformance of benchmark in terms of weighted average ESG Score.
- Application of the following sustainable minimum exclusion criteria for direct investments:
 - securities issued by companies having a severe violation / breach of principles and guidelines such as the Principles of the United Nations Global Compact, the OECD Guidelines for Multinational Enterprises, and the United Nations Guiding Principles for Business and Human Rights on the grounds of problematic practices around human rights, labour rights, environment, and corruption,
 - securities issued by companies involved in controversial weapons (anti-personnel mines, cluster munitions, chemical weapons, biological weapons, depleted uranium, white phosphorus, and nuclear weapons),
 - securities issued by companies that derive more than 10% of their revenues from weapons, military equipment, and services,
 - securities issued by companies that derive more than 10% of their revenue from thermal coal extraction
 - securities issued by utility companies that generate more than 20% of their revenues from coal,
 - securities issued by companies involved in the production of tobacco, and securities issued by companies involved in the distribution of tobacco with more than 5% of their revenues.

Direct investments in sovereign issuers with an insufficient freedom house index score are excluded.

The sustainable minimum exclusion criteria are based on information from an external data provider and coded in pre- and post-trade compliance. The review is performed at least half yearly.

- **What is the committed minimum rate to reduce the scope of the investments considered prior to the application of that investment strategy?**

The Sub-Fund does not commit to reduce the scope of the investments by a certain minimum rate.

- **What is the policy to assess good governance practices of the investee companies?**

Good governance principles are considered by screening out companies based on their involvement in controversies around international norms corresponding to the four good governance practices: sound management structures, employee relations, remuneration of staff and tax compliance. Companies having a severe violation in either of those areas will not be investible. For certain cases, flagged issuers shall be on a watch list. These companies will appear on this watch list when the Investment Manager believes that engagement may lead to improvements or when the company is assessed to take remedial actions. Companies on the watch list remain investible unless the Investment Manager believes that the engagement or the remedial actions of the company does not lead to the desired remedy of the severe controversy.

In addition, the Sub-Fund’s Investment Manager is committed to actively encourage open dialogues with investee companies on corporate governance, proxy voting and broader sustainability issues in advance of shareholder meetings (regularly for direct investments in shares). The Sub-Fund’s Investment Manager’s approach to proxy voting and company engagement is set out in the Management Company’s Stewardship Statement.

Good governance practices include sound management structures, employee relations, remuneration of staff and tax compliance.



What is the asset allocation planned for this financial product?

Asset allocation describes the share of investments in specific assets.

Min. 80% of the Sub-Funds’ assets (excluding cash, and derivatives) are used to meet the environmental or social characteristics promoted by this Sub-Fund. A low portion of the Sub-Fund might contain assets which do not promote environmental or social characteristics. Example of such instruments are derivatives, cash and deposits, some Target Funds and investment with temporarily divergent or absent environmental, social, or good governance qualifications. Min. 5% of the Sub-Funds’ assets will be invested in Sustainable Investments. The Sub-Fund’s Investment Manager does not commit to a minimum share of sustainable investments with an environmental objective aligned with the EU Taxonomy nor to a minimum share of environmentally Sustainable Investments that are not aligned with the EU Taxonomy. The Sub-Fund’s Investment Manager does not commit to a minimum share of socially sustainable investments. While the Sub-Fund cannot commit to a minimum share of environmentally or socially sustainable investments, such investments may be freely allocated to within the Sub-Fund aggregated sustainable investment commitment disclosed (min. 5%).

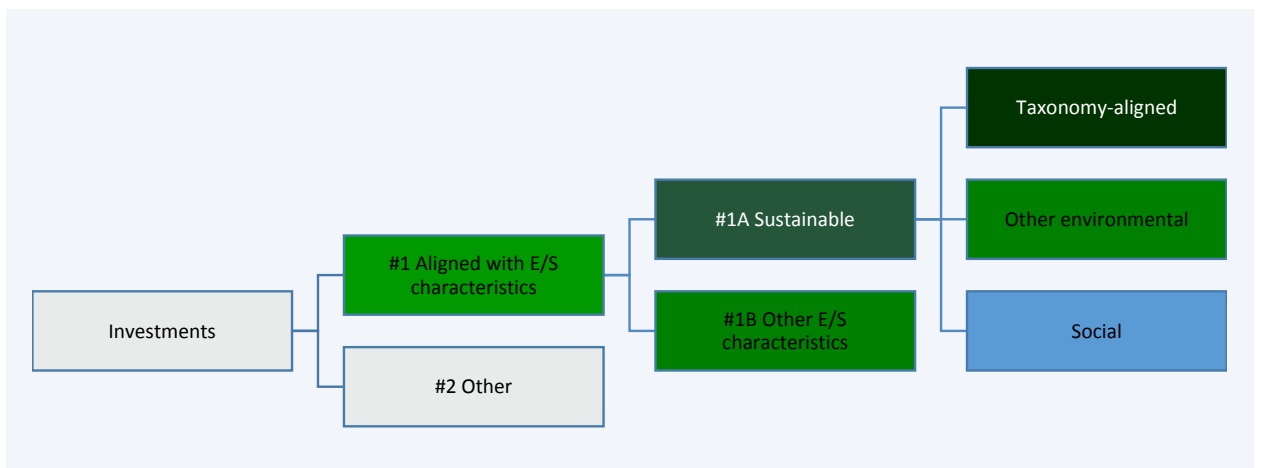

#1 Aligned with E/S characteristics includes the investments of the financial product used to attain the environmental or social characteristics promoted by the financial product.

#2 Other includes the remaining investments of the financial product which are neither aligned with the environmental or social characteristics, nor are qualified as sustainable investments.

The category **#1 Aligned with E/S characteristics** covers:

- The sub-category **#1A Sustainable** covers sustainable investments with environmental or social objectives.
- The sub-category **#1B Other E/S characteristics** covers investments aligned with the environmental or social characteristics that do not qualify as sustainable investments.

- How does the use of derivatives attain the environmental or social characteristics promoted by the financial product?

Not applicable



To what minimum extent are sustainable investments with an environmental objective aligned with the EU Taxonomy?

The Sub-Fund's Investment Manager does not commit to a minimum share of sustainable investments with an environmental objective aligned with the EU Taxonomy. The overall sustainable investment share may also include investments with an environmental objective in economic activities that qualify as environmentally sustainable under the EU Taxonomy.

- Does the financial product invest in fossil gas and/or nuclear energy related activities that comply with the EU Taxonomy ¹?

- Yes:
- In fossil gas
 - In nuclear energy
- No

The Sub-Fund does not pursue any investments in fossil gas and/or nuclear energy related activities that comply with the EU Taxonomy. Nevertheless, as result of this investment strategy, investments may occur in corporates which are also active in these activities. Further information will be provided as part of the annual reporting, if relevant.

The two graphs below show in green the minimum percentage of investments that are aligned with the EU Taxonomy. As there is no appropriate methodology to determine the Taxonomy-alignment of sovereign bonds*, the first graph shows the Taxonomy-alignment in relation to all the investments of the financial product including sovereign bonds, while the second graph shows the Taxonomy-alignment only in relation to the investments of the financial product other than sovereign bonds.

1. Taxonomy-alignment of investments including sovereign bonds*

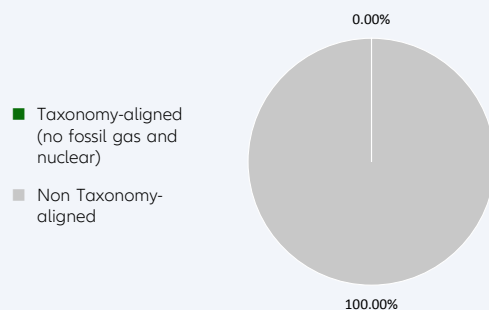

2. Taxonomy-alignment of investments excluding sovereign bonds*

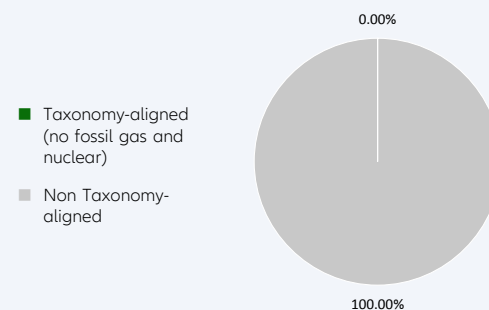

This graph represents X% of the total investments. It is noted that – due to the fact that this Sub-Fund does not provide for a minimum quota of taxonomy-aligned investments – this graph does not generate any additional added value compared to the left-hand graph.

* For the purpose of these graphs, 'sovereign bonds' consist of all sovereign exposures

- What is the minimum share of investments in transitional and enabling activities?

The Sub-Fund's Investment Manager does not commit to a split of minimum taxonomy alignment into transitional, enabling activities and own performance.

Taxonomy-aligned activities are expressed as a share of:

- **turnover** reflecting the share of revenue from green activities of investee companies
- **capital expenditure** (CapEx) showing the green investments made by investee companies, e.g. for a transition to a green economy.
- **operational expenditure** (OpEx) reflecting green operational activities of investee companies.

Enabling activities directly enable other activities to make a substantial contribution to an environmental objective.

Transitional activities are activities for which low-carbon alternatives are not yet available

¹ Fossil gas and/or nuclear related activities will only comply with the EU Taxonomy where they contribute to limiting climate change ("climate change mitigation") and do not significantly harm any EU Taxonomy objective - see explanatory note in the left hand margin. The full criteria for fossil gas and nuclear energy economic activities that comply with the EU Taxonomy are laid down in Commission Delegated Regulation (EU) 2022/1214.

and among others have greenhouse gas emission levels corresponding to the best performance.



What is the minimum share of sustainable investments with an environmental objective that are not aligned with the EU Taxonomy?

Taxonomy-aligned investments are considered a sub-category of Sustainable Investments. If an investment is not Taxonomy-aligned since the activity is not yet covered under the EU Taxonomy or the positive contribution is not substantial enough to comply with the Taxonomy technical screening criteria, the investment can still be considered an environmentally Sustainable Investment provided it complies with all criteria. The Investment Manager does not commit to a minimum share of environmentally Sustainable Investments that are not aligned with the EU Taxonomy. The overall sustainable investment share may also include investments with an environmental objective in economic activities that do not qualify as environmentally sustainable under the EU Taxonomy, and while the Sub-Fund cannot commit to a minimum share of environmentally or socially sustainable investments, such investments may be freely allocated to within the Sub-Fund aggregated sustainable investment commitment disclosed (min. 5%).



are sustainable investments with an environmental objective that **do not take into account the criteria** for environmentally sustainable economic activities under the EU Taxonomy.



What is the minimum share of socially sustainable investments?

The Investment Manager defines Sustainable Investments based on internal research, which uses, among others, the UN Sustainable Development Goals (SDGs), as well as the objectives of the EU Taxonomy as reference frameworks. The Investment Manager does not commit to a minimum share of socially Sustainable Investments, as the SDGs contain environmental as well as social objectives. The overall sustainable investment share may also include investments with a social objective, and while the Sub-Fund cannot commit to a minimum share of environmentally or socially sustainable investments, such investments may be freely allocated to within the Sub-Fund aggregated sustainable investment commitment disclosed (min. 5%).



What investments are included under “#2 Other”, what is their purpose and are there any minimum environmental or social safeguards?

Under “#2 Other” investments into cash, Target Funds, or derivatives can be included. Derivatives might be used for efficient portfolio management (including risk hedging) and/or investment purposes, and Target Funds to benefit from a specific strategy. For those investments no environmental or social safeguards are applied.



Is a specific index designated as a reference benchmark to determine whether this financial product is aligned with the environmental and/or social characteristics that it promotes?

Yes, the Sub-Fund has assigned the MSCI China All Shares Total Return Net as a benchmark. This benchmark is a market index. The Sub-Fund will promote environmental and social characteristics by outperforming the benchmark's Weighted ESG Score.

Reference benchmarks are indexes to measure whether the financial product attains the environmental or social characteristics that they promote.

- **How is the reference benchmark continuously aligned with each of the environmental or social characteristics promoted by the financial product?**

The benchmark is a market index and does not incorporate environmental or social characteristics for index construction.

- **How is the alignment of the investment strategy with the methodology of the index ensured on a continuous basis?**

The benchmark is not continuously aligned as it does not incorporate environmental or social characteristics for index construction.

- **How does the designated index differ from a relevant broad market index?**

The benchmark is a broad market index.

- **Where can the methodology used for the calculation of the designated index be found?**

Details of the Benchmark's methodology may be found at <https://www.msci.com/documents/10199/d84b06d0-b81c-48ce-89b8-c57f808065e4> or at www.msci.com



Where can I find more product specific information online?

More product-specific information can be found on the website: <https://regulatory.allianzgi.com/SFDR>

Template pre-contractual disclosure for the financial products referred to in Article 8, paragraphs 1, 2 and 2a, of Regulation (EU) 2019/2088 and Article 6, first paragraph, of Regulation (EU) 2020/852

Product name:

Allianz Clean Planet

Legal entity identifier: 5299003YJB0A9U4O4D87

Environmental and/or social characteristics

Sustainable investment means an investment in an economic activity that contributes to an environmental or social objective, provided that the investment does not significantly harm any environmental or social objective and that the investee companies follow good governance practices.

The **EU Taxonomy** is a classification system laid down in Regulation (EU) 2020/852, establishing a list of **environmentally sustainable economic activities**. That Regulation does not include a list of socially sustainable economic activities. Sustainable investments with an environmental objective might be aligned with the Taxonomy or not.

Does this financial product have a sustainable investment objective?	
Yes	No
<input type="checkbox"/> It will make a minimum of sustainable investments with an environmental objective : ____% <input type="checkbox"/> in economic activities that qualify as environmentally sustainable under the EU Taxonomy <input type="checkbox"/> in economic activities that do not qualify as environmentally sustainable under the EU Taxonomy	<input checked="" type="checkbox"/> It promotes Environmental/Social (E/S) characteristics and while it does not have as its objective a sustainable investment, it will have a minimum proportion of 50.00% of sustainable investments <input checked="" type="checkbox"/> with an environmental objective in economic activities that qualify as environmentally sustainable under the EU Taxonomy <input checked="" type="checkbox"/> with an environmental objective in economic activities that do not qualify as environmentally sustainable under the EU Taxonomy <input checked="" type="checkbox"/> with a social objective
<input type="checkbox"/> It will make a minimum of sustainable investments with a social objective ____%	<input type="checkbox"/> It promotes E/S characteristics, but will not make any sustainable investments



What environmental and/or social characteristics are promoted by this financial product?

Allianz Clean Planet (the "Sub-Fund") invests in securities of companies providing products or services which contribute to environmental or social objectives, as defined by the UN Sustainable Development Goals (SDGs) or the EU Taxonomy objectives, which are also related to the SDGs. The contribution is measured according to the Sustainable Investment methodology.

In addition, sustainable minimum exclusion criteria apply.

No reference benchmark has been designated for the purpose of attaining the environmental and/or social characteristics promoted by the Sub-Fund.

What sustainability indicators are used to measure the attainment of each of the environmental or social characteristics promoted by this financial product?

To measure the attainment of the Sub-Fund's sustainable investment objective the following sustainability indicators are used and reported on, at the fiscal year end:

- The actual Sustainable Investment share – which is based on SDGs or EU Taxonomy objectives
- Principle Adverse Impacts (PAIs) of investment decisions on sustainability factors are considered through the application of exclusion criteria.

Sustainability indicators measure how the environmental or social characteristics promoted by the financial product are attained.

- **What are the objectives of the sustainable investments that the financial product partially intends to make and how does the sustainable investment contribute to such objectives?**

Sustainable investments contribute to environmental and/or social objectives, for which the Investment Manager uses as reference frameworks, among others, the UN Sustainable Development Goals (SDGs), as well as the objectives of the EU Taxonomy:

1. Climate Change Mitigation
2. Climate Change Adaptation
3. Sustainable Use and Protection of Water and Marine Resources
4. Transition to a Circular Economy
5. Pollution Prevention and Control
6. Protection and Restoration of Biodiversity and Ecosystems

The assessment of the positive contribution to the environmental or social objectives is based on a proprietary framework which combines quantitative elements with qualitative inputs from internal research. The methodology applies first a quantitative breakdown of a securities issuer into its business activities. The qualitative element of the framework is an assessment if business activities contribute positively to an environmental or a social objective.

To calculate the positive contribution on the Sub-Fund level the revenue share of each issuer attributable to business activities contributing to environmental and/or social objectives is considered provided the issuer is satisfying the Do No Significant Harm (“DNSH”) and Good Governance principles, and an asset-weighted aggregation is performed as a second step. Moreover, for certain types of securities, which finance specific projects contributing to environmental or social objectives the overall investment is considered to contribute to environmental and/or social objectives, but also for these a DNSH as well as a Good Governance check for issuers is performed.

- **How do the sustainable investments that the financial product partially intends to make, not cause significant harm to any environmental or social sustainable investment objective?**

In order to ensure that Sustainable Investments do not significantly harm any other environmental and/or social objective, the Investment Manager is leveraging the PAI indicators, whereby significance thresholds have been defined to identify significantly harmful issuers. Issuers not meeting the significance threshold can be engaged for a limited time period to remediate the adverse impact. Otherwise, if the issuer does not meet the defined significance thresholds twice subsequently or in case of a failed engagement, it does not pass the DNSH assessment. Investments in securities of issuers which do not pass the DNSH assessment are not counted as sustainable investments.

- *How have the indicators for adverse impacts on sustainability factors been taken into account?*

All mandatory PAI indicators are considered either as part of the application of the exclusion criteria or through thresholds on a sectorial or absolute basis. Significance thresholds have been defined and they refer to qualitative or quantitative criteria.

Recognizing the lack of data coverage for some of the PAI indicators equivalent data points are used to assess PAI indicators when applying the DNSH assessment, when relevant, for the following indicators for corporates: share of non-renewable energy consumption and production, activities negatively affecting biodiversity-sensitive areas, emissions to water, lack of processes and compliance mechanisms to monitor compliance with UNGC principles and OECD Guidelines for Multinational Enterprises; for sovereigns: GHG Intensity and investee countries subject to social violations. In case of securities which finance specific projects contributing to environmental or social objectives equivalent data at project level might be used to ensure that Sustainable Investments do not significantly harm any other environmental and/or social objective. The Investment Manager will strive to increase data coverage for PAI indicators with low data coverage by engaging with issuers and data providers. The Investment Manager will regularly evaluate whether the availability of data has increased sufficiently to potentially include assessment of such data in the investment process.

- *How are the sustainable investments aligned with the OECD Guidelines for Multinational Enterprises and the UN Guiding Principles on Business and Human Rights? Details:*

The Investment Manager’s sustainable minimum exclusion list screens out companies based on their involvement in controversial practices against international norms. The core normative framework consists of the Principles of the UN Global Compact, the OECD Guidelines for Multinational Enterprises

Principal adverse impacts are the most significant negative impacts of investment decisions on sustainability factors relating to environmental, social and employee matters, respect for human rights, anti-corruption and anti-bribery matters.

and the UN Guiding Principles for Business and Human Rights. Securities issued by companies having a severe violation of these frameworks will be restricted from the investment universe.

The EU Taxonomy sets out a “do not significant harm” principle by which Taxonomy-aligned investments should not significantly harm EU Taxonomy objectives and is accompanied by specific EU criteria.

The “do not significant harm” principle applies only to those investments underlying the financial product that take into account the EU criteria for environmentally sustainable economic activities. The investments underlying the remaining portion of this financial product do not take into account the EU criteria for environmentally sustainable economic activities.

Any other sustainable investments must also not significantly harm any environmental or social objectives.



Does this financial product consider principal adverse impacts on sustainability factors?

Yes

No

The Management Company has joined the Net Zero Asset Manager Initiative and considers PAI indicators through stewardship including engagement, both are relevant to mitigate potential adverse impact as a company.

Due to the commitment to the Net Zero Asset Manager Initiative, the Management Company aims to reduce greenhouse gas emissions in partnership with asset owner clients on decarbonisation goals, consistent with an ambition to reach net zero emission by 2050 or sooner across all assets under management. As part of this objective the Management Company will set an interim target for the proportion of assets to be managed in line with the attainment of net zero emissions by 2050 or sooner.

The Sub-Fund’s Investment Manager considers PAI indicators regarding greenhouse gas emission, biodiversity, water, waste as well as social and employee matters for corporate issuers, and, where relevant, the freedom house index is applied to investments in sovereigns. PAI indicators are considered within the Investment Manager’s investment process through the means of exclusions as described in the “binding elements” section of the Sub-Fund.

The data coverage for the data required for the PAI indicators is heterogenous. The data coverage related to biodiversity, water and waste is low and the related PAI indicators are considered through exclusion of securities issued by companies having a severe violation / breach of principles and guidelines such as the Principles of the United Nations Global Compact, the OECD Guidelines for Multinational Enterprises, and the United Nations Guiding Principles for Business and Human Rights on the grounds of problematic practices around human rights, labour rights, environment, and corruption issues. Therefore, the Investment Manager will strive to increase data coverage for PAI indicators with low data coverage. The Investment Manager will regularly evaluate whether the availability of data has increased sufficiently to potentially include assessment of such data in the investment process.

Additionally, PAI indicators are considered as part of the requirement of the Sub-Fund to invest 50% into Sustainable Investments. PAI indicators are used as part of the DNSH assessment. Investments in securities of issuers who do not pass the DNSH assessment are not counted as sustainable investments.

The following PAI indicators are considered:

Applicable to corporate issuers

- GHG Emissions
- Carbon footprint
- GHG Intensity of investee companies
- Exposure to companies active in the fossil fuel sector
- Share of non-renewable energy consumption and production
- Energy consumption intensity per high impact climate sector
- Activities negatively affecting biodiversity-sensitive areas
- Emissions to water
- Hazardous waste ratio
- Violation of UN Global compact principles

- Lack of processes and compliance mechanisms to monitor compliance with UN Global Compact principles
- Unadjusted gender pay gap
- Board gender diversity
- Exposure to controversial weapons

Applicable to sovereign and supranational issuers

- GHG Intensity
- Investee countries subject to social violations

The information on the PAI indicators will be available in the end-year report of the Sub-Fund.



What investment strategy does this financial product follow?

The investment strategy guides investment decisions based on factors such as investment objectives and risk tolerance.

Allianz Clean Planet's investment objective is to invest in global Equity Markets with a focus on companies with an engagement in the area of a cleaner environment in accordance with the SDG-Aligned Strategy.

The Sub-Fund invests in Equities of companies which offer products and services across themes. Companies engaging in the area of a cleaner environment which offer products or services with active positive contribution to the improvement of challenges related to three key dimensions of a clean environment which include the core themes (i) clean land, (ii) energy transition, and (iii) clean water as targeted by the SDGs No. 2, 3, 6, 7, 9, 12, 13, 14 and 15.

The Sub-Fund's general investment approach (Sub-Fund's applicable General Asset Class Principles in combination with its individual investment restrictions) is described in the prospectus.

● What are the binding elements of the investment strategy used to select the investments to attain each of the environmental or social characteristics promoted by this financial product?

The binding elements are:

- Minimum 50% of the Sub-Fund assets' weighted average shall result from revenue generated from issuers' activities that facilitate the achievement of one or more SDG or EU Taxonomy objectives as measured according to the Sustainable Investment methodology.
- For at least 80% of the Sub-Fund portfolio, the respective issuer shall have a minimum share of 20% Sustainable Investments. Cash and derivatives are excluded from the aforesaid thresholds.
- Application of the following sustainable minimum exclusion criteria for direct investments:
 - securities issued by companies having a severe violation / breach of principles and guidelines such as the Principles of the United Nations Global Compact, the OECD Guidelines for Multinational Enterprises, and the United Nations Guiding Principles for Business and Human Rights on the grounds of problematic practices around human rights, labour rights, environment, and corruption issues,
 - securities issued by companies involved in controversial weapons (anti-personnel mines, cluster munitions, chemical weapons, biological weapons, depleted uranium, white phosphorus, and nuclear weapons),
 - securities issued by companies that derive more than 10% of their revenues from weapons, military equipment, and services,
 - securities issued by companies that derive more than 10% of their revenue from thermal coal extraction,
 - securities issued by utility companies that generate more than 20% of their revenues from coal,
 - securities issued by companies involved in the production of tobacco, and securities issued by companies involved in the distribution of tobacco with more than 5% of their revenues.

Direct investments in sovereign issuers with an insufficient freedom house index score are excluded.

The sustainable minimum exclusion criteria are based on information from an external data provider and coded in pre- and post-trade compliance. The review is performed at least half yearly.

- **What is the committed minimum rate to reduce the scope of the investments considered prior to the application of that investment strategy?**

The Sub-Fund does not commit to reduce the scope of the investments by a certain minimum rate.

- **What is the policy to assess good governance practices of the investee companies?**

Good governance principles are considered by screening out companies based on their involvement in controversies around international norms corresponding to the four good governance practices: sound management structures, employee relations, remuneration of staff and tax compliance. Companies having a severe violation in either of those areas will not be investible. For certain cases, flagged issuers shall be on a watch list. These companies will appear on this watch list when the Investment Manager believes that engagement may lead to improvements or when the company is assessed to take remedial actions. Companies on the watch list remain investible unless the Investment Manager believes that the engagement or the remedial actions of the company does not lead to the desired remedy of the severe controversy.

In addition, the Sub-Fund’s Investment Manager is committed to actively encourage open dialogues with investee companies on corporate governance, proxy voting and broader sustainability issues in advance of shareholder meetings (regularly for direct investments in shares). The Sub-Fund’s Investment Manager’s approach to proxy voting and company engagement is set out in the Management Company’s Stewardship Statement.

Good governance practices include sound management structures, employee relations, remuneration of staff and tax compliance.



What is the asset allocation planned for this financial product?

Asset allocation describes the share of investments in specific assets.

Min. 80% of the Sub-Funds’ assets (excluding cash, and derivatives) are used to meet the environmental or social characteristics promoted by this Sub-Fund. A low portion of the Sub-Fund might contain assets which do not promote environmental or social characteristics. Example of such instruments are derivatives, cash and deposits, some Target Funds and investment with temporarily divergent or absent environmental, social, or good governance qualifications. The Sub-Fund invest primarily into securities which offer products and services to facilitate the achievements of the SDGs. Min. 50% of the Sub-Funds' assets will be invested in Sustainable Investments. The Sub-Fund’s Investment Manager does not commit to a minimum share of sustainable investments with an environmental objective aligned with the EU Taxonomy nor to a minimum share of environmentally Sustainable Investments that are not aligned with the EU Taxonomy. The Sub-Fund’s Investment Manager does not commit to a minimum share of socially sustainable investments. While the Sub-Fund cannot commit to a minimum share of environmentally or socially sustainable investments, such investments may be freely allocated to within the Sub-Fund aggregated sustainable investment commitment disclosed (min. 50%).

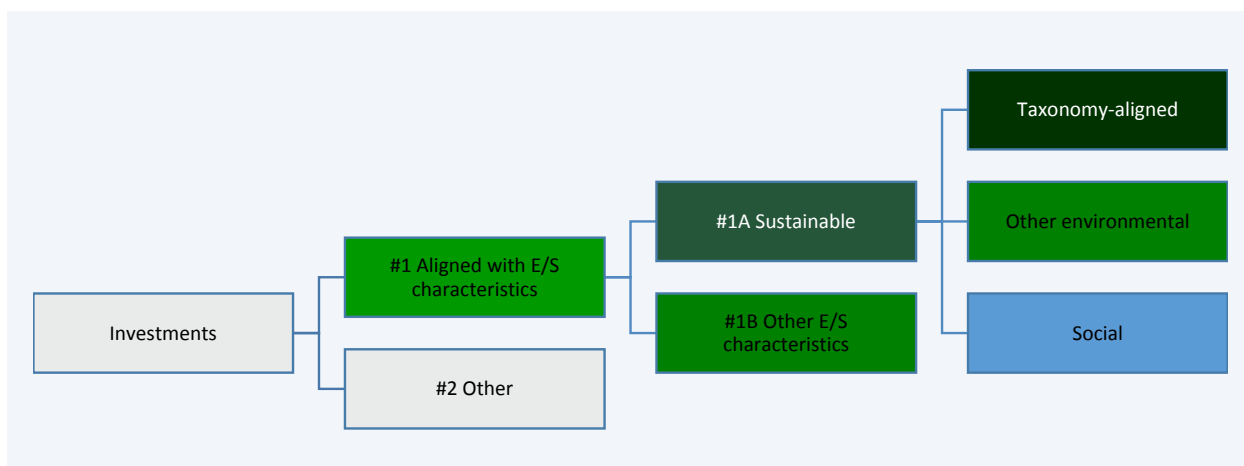

#1 Aligned with E/S characteristics includes the investments of the financial product used to attain the environmental or social characteristics promoted by the financial product.

#2 Other includes the remaining investments of the financial product which are neither aligned with the environmental or social characteristics, nor are qualified as sustainable investments.

The category **#1 Aligned with E/S characteristics** covers:

- The sub-category **#1A Sustainable** covers sustainable investments with environmental or social objectives.
- The sub-category **#1B Other E/S characteristics** covers investments aligned with the environmental or social characteristics that do not qualify as sustainable investments.

- How does the use of derivatives attain the environmental or social characteristics promoted by the financial product?

Not applicable



To what minimum extent are sustainable investments with an environmental objective aligned with the EU Taxonomy?

The Sub-Fund's Investment Manager does not commit to a minimum share of sustainable investments with an environmental objective aligned with the EU Taxonomy. The overall sustainable investment share may also include investments with an environmental objective in economic activities that qualify as environmentally sustainable under the EU Taxonomy.

- Does the financial product invest in fossil gas and/or nuclear energy related activities that comply with the EU Taxonomy ¹?

- Yes:
- In fossil gas
 - In nuclear energy
- No

The Sub-Fund does not pursue any investments in fossil gas and/or nuclear energy related activities that comply with the EU Taxonomy. Nevertheless, as result of this investment strategy, investments may occur in corporates which are also active in these activities. Further information will be provided as part of the annual reporting, if relevant.

The two graphs below show in green the minimum percentage of investments that are aligned with the EU Taxonomy. As there is no appropriate methodology to determine the Taxonomy-alignment of sovereign bonds*, the first graph shows the Taxonomy-alignment in relation to all the investments of the financial product including sovereign bonds, while the second graph shows the Taxonomy-alignment only in relation to the investments of the financial product other than sovereign bonds.

1. Taxonomy-alignment of investments including sovereign bonds*

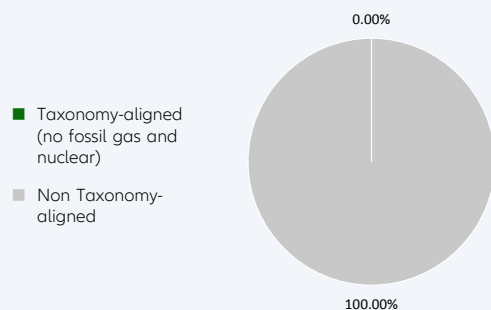

2. Taxonomy-alignment of investments excluding sovereign bonds*

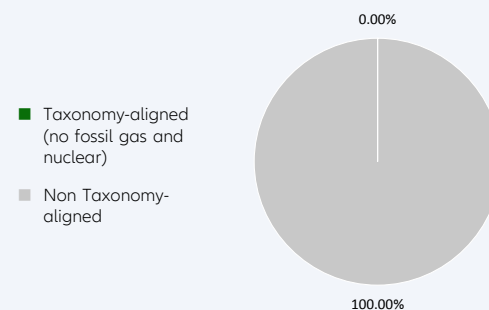

This graph represents X% of the total investments. It is noted that – due to the fact that this Sub-Fund does not provide for a minimum quota of taxonomy-aligned investments – this graph does not generate any additional added value compared to the left-hand graph.

* For the purpose of these graphs, 'sovereign bonds' consist of all sovereign exposures

- What is the minimum share of investments in transitional and enabling activities?

The Sub-Fund's Investment Manager does not commit to a split of minimum taxonomy alignment into transitional, enabling activities and own performance.

Taxonomy-aligned activities are expressed as a share of:

- **turnover** reflecting the share of revenue from green activities of investee companies
- **capital expenditure** (CapEx) showing the green investments made by investee companies, e.g. for a transition to a green economy.
- **operational expenditure** (OpEx) reflecting green operational activities of investee companies.

Enabling activities directly enable other activities to make a substantial contribution to an environmental objective.

Transitional activities are activities for which low-carbon alternatives are not yet available

¹ Fossil gas and/or nuclear related activities will only comply with the EU Taxonomy where they contribute to limiting climate change ("climate change mitigation") and do not significantly harm any EU Taxonomy objective - see explanatory note in the left hand margin. The full criteria for fossil gas and nuclear energy economic activities that comply with the EU Taxonomy are laid down in Commission Delegated Regulation (EU) 2022/1214.

and among others have greenhouse gas emission levels corresponding to the best performance.



What is the minimum share of sustainable investments with an environmental objective that are not aligned with the EU Taxonomy?

Taxonomy-aligned investments are considered a sub-category of Sustainable Investments. If an investment is not Taxonomy-aligned since the activity is not yet covered under the EU Taxonomy or the positive contribution is not substantial enough to comply with the Taxonomy technical screening criteria, the investment can still be considered an environmentally Sustainable Investment provided it complies with all criteria. The Investment Manager does not commit to a minimum share of environmentally Sustainable Investments that are not aligned with the EU Taxonomy. The overall sustainable investment share may also include investments with an environmental objective in economic activities that do not qualify as environmentally sustainable under the EU Taxonomy, and while the Sub-Fund cannot commit to a minimum share of environmentally or socially sustainable investments, such investments may be freely allocated to within the Sub-Fund aggregated sustainable investment commitment disclosed (min. 50%).



are sustainable investments with an environmental objective that **do not take into account the criteria** for environmentally sustainable economic activities under the EU Taxonomy.



What is the minimum share of socially sustainable investments?

The Investment Manager defines Sustainable Investments based on internal research, which uses, among others, the UN Sustainable Development Goals (SDGs), as well as the objectives of the EU Taxonomy as reference frameworks. The Investment Manager does not commit to a minimum share of socially Sustainable Investments, as the SDGs contain environmental as well as social objectives. The overall sustainable investment share may also include investments with a social objective, and while the Sub-Fund cannot commit to a minimum share of environmentally or socially sustainable investments, such investments may be freely allocated to within the Sub-Fund aggregated sustainable investment commitment disclosed (min. 50%).



What investments are included under “#2 Other”, what is their purpose and are there any minimum environmental or social safeguards?

Under “#2 Other” investments into cash, Target Funds, or derivatives can be included. Derivatives might be used for efficient portfolio management (including risk hedging) and/or investment purposes, and Target Funds to benefit from a specific strategy. For those investments no environmental or social safeguards are applied.



Is a specific index designated as a reference benchmark to determine whether this financial product is aligned with the environmental and/or social characteristics that it promotes?

No reference benchmark has been designated for the purpose of attaining the environmental and/or social characteristics promoted by the Sub-Fund.

Reference benchmarks are indexes to measure whether the financial product attains the environmental or social characteristics that they promote.

- How is the reference benchmark continuously aligned with each of the environmental or social characteristics promoted by the financial product?

Not applicable

- How is the alignment of the investment strategy with the methodology of the index ensured on a continuous basis?

Not applicable

- How does the designated index differ from a relevant broad market index?
Not applicable
- Where can the methodology used for the calculation of the designated index be found?
Not applicable



Where can I find more product specific information online?

More product-specific information can be found on the website: <https://regulatory.allianzgi.com/SFDR>

Template pre-contractual disclosure for the financial products referred to in Article 8, paragraphs 1, 2 and 2a, of Regulation (EU) 2019/2088 and Article 6, first paragraph, of Regulation (EU) 2020/852

Product name:

Allianz Climate Transition

Legal entity identifier: 52990080FLOXFRNVGP49

Environmental and/or social characteristics

Sustainable investment means an investment in an economic activity that contributes to an environmental or social objective, provided that the investment does not significantly harm any environmental or social objective and that the investee companies follow good governance practices.

The EU Taxonomy is a classification system laid down in Regulation (EU) 2020/852, establishing a list of **environmentally sustainable economic activities**. That Regulation does not include a list of socially sustainable economic activities. Sustainable investments with an environmental objective might be aligned with the Taxonomy or not.

Does this financial product have a sustainable investment objective?	
<input checked="" type="radio"/> <input checked="" type="radio"/> Yes	<input checked="" type="radio"/> <input type="radio"/> No
<input type="checkbox"/> It will make a minimum of sustainable investments with an environmental objective: ___% <ul style="list-style-type: none"> <input type="checkbox"/> in economic activities that qualify as environmentally sustainable under the EU Taxonomy <input type="checkbox"/> in economic activities that do not qualify as environmentally sustainable under the EU Taxonomy 	<input checked="" type="checkbox"/> It promotes Environmental/Social (E/S) characteristics and while it does not have as its objective a sustainable investment, it will have a minimum proportion of 15.00% of sustainable investments <ul style="list-style-type: none"> <input checked="" type="checkbox"/> with an environmental objective in economic activities that qualify as environmentally sustainable under the EU Taxonomy <input checked="" type="checkbox"/> with an environmental objective in economic activities that do not qualify as environmentally sustainable under the EU Taxonomy <input checked="" type="checkbox"/> with a social objective
<input type="checkbox"/> It will make a minimum of sustainable investments with a social objective ___%	<input type="checkbox"/> It promotes E/S characteristics, but will not make any sustainable investments



What environmental and/or social characteristics are promoted by this financial product?

Allianz Climate Transition (the "Sub-Fund") promotes environmental, social, human rights, governance, and business behaviour factors (this domain does not apply for sovereigns issued by a Sovereign Entity) through integration of a best-in-class approach into the Sub-Fund's investment process. This encompasses the evaluation of corporate or sovereign issuers based on an SRI Rating which is used to construct the portfolio.

In addition, sustainable minimum exclusion criteria apply.

No reference benchmark has been designated for the purpose of attaining the environmental and/or social characteristics promoted by the Sub-Fund.

● What sustainability indicators are used to measure the attainment of each of the environmental or social characteristics promoted by this financial product?

To measure the attainment of the environmental and/or social characteristics the following sustainability indicators are used and reported on, at the fiscal year end:

- The actual percentage of the Sub-Fund's Portfolio (Portfolio in this respect does not comprise non-rated derivatives and instruments that are non-rated by nature (e. g., cash and deposits)) invested in best-in-class issuers (issuers with a minimum SRI Rating of 2 out of a scale from 0-4) is compared to the actual percentage of the benchmarks best-in-class issuers.
- Adherence to a 20% reduction of the investment universe

Sustainability indicators measure how the environmental or social characteristics promoted by the financial product are attained.

- Confirmation that Principal Adverse Impacts (PAIs) of investment decisions on sustainability factors are considered through the application of exclusion criteria.

- **What are the objectives of the sustainable investments that the financial product partially intends to make and how does the sustainable investment contribute to such objectives?**

Sustainable investments contribute to environmental and/or social objectives, for which the Investment Manager uses as reference frameworks, among others, the UN Sustainable Development Goals (SDGs), as well as the objectives of the EU Taxonomy:

1. Climate Change Mitigation
2. Climate Change Adaptation
3. Sustainable Use and Protection of Water and Marine Resources
4. Transition to a Circular Economy
5. Pollution Prevention and Control
6. Protection and Restoration of Biodiversity and Ecosystems

The assessment of the positive contribution to the environmental or social objectives is based on a proprietary framework which combines quantitative elements with qualitative inputs from internal research. The methodology applies first a quantitative breakdown of a securities issuer into its business activities. The qualitative element of the framework is an assessment if business activities contribute positively to an environmental or a social objective.

To calculate the positive contribution on the Sub-Fund level the revenue share of each issuer attributable to business activities contributing to environmental and/or social objectives is considered provided the issuer is satisfying the Do No Significant Harm (“DNSH”) and Good Governance principles, and an asset-weighted aggregation is performed as a second step. Moreover, for certain types of securities, which finance specific projects contributing to environmental or social objectives the overall investment is considered to contribute to environmental and/or social objectives, but also for these a DNSH as well as a Good Governance check for issuers is performed.

- **How do the sustainable investments that the financial product partially intends to make, not cause significant harm to any environmental or social sustainable investment objective?**

In order to ensure that Sustainable Investments do not significantly harm any other environmental and/or social objective, the Investment Manager is leveraging the PAI indicators, whereby significance thresholds have been defined to identify significantly harmful issuers. Issuers not meeting the significance threshold can be engaged for a limited time period to remediate the adverse impact. Otherwise, if the issuer does not meet the defined significance thresholds twice subsequently or in case of a failed engagement, it does not pass the DNSH assessment. Investments in securities of issuers which do not pass the DNSH assessment are not counted as sustainable investments.

- *How have the indicators for adverse impacts on sustainability factors been taken into account?*

All mandatory PAI indicators are considered either as part of the application of the exclusion criteria or through thresholds on a sectorial or absolute basis. Significance thresholds have been defined and they refer to qualitative or quantitative criteria.

Recognizing the lack of data coverage for some of the PAI indicators equivalent data points are used to assess PAI indicators when applying the DNSH assessment, when relevant, for the following indicators for corporates: share of non-renewable energy consumption and production, activities negatively affecting biodiversity-sensitive areas, emissions to water, lack of processes and compliance mechanisms to monitor compliance with UNGC principles and OECD Guidelines for Multinational Enterprises; for sovereigns: GHG Intensity and investee countries subject to social violations. In case of securities which finance specific projects contributing to environmental or social objectives equivalent data at project level might be used to ensure that Sustainable Investments do not significantly harm any other environmental and/or social objective. The Investment Manager will strive to increase data coverage for PAI indicators with low data coverage by engaging with issuers and data providers. The Investment Manager will regularly evaluate whether the availability of data has increased sufficiently to potentially include assessment of such data in the investment process.

Principal adverse impacts are the most significant negative impacts of investment decisions on sustainability factors relating to environmental, social and employee matters, respect for human rights, anti-corruption and anti-bribery matters.

- *How are the sustainable investments aligned with the OECD Guidelines for Multinational Enterprises and the UN Guiding Principles on Business and Human Rights? Details:*

The Investment Manager's sustainable minimum exclusion list screens out companies based on their involvement in controversial practices against international norms. The core normative framework consists of the Principles of the UN Global Compact, the OECD Guidelines for Multinational Enterprises and the UN Guiding Principles for Business and Human Rights. Securities issued by companies having a severe violation of these frameworks will be restricted from the investment universe.

The EU Taxonomy sets out a "do not significant harm" principle by which Taxonomy-aligned investments should not significantly harm EU Taxonomy objectives and is accompanied by specific EU criteria.

The "do not significant harm" principle applies only to those investments underlying the financial product that take into account the EU criteria for environmentally sustainable economic activities. The investments underlying the remaining portion of this financial product do not take into account the EU criteria for environmentally sustainable economic activities.

Any other sustainable investments must also not significantly harm any environmental or social objectives.



Does this financial product consider principal adverse impacts on sustainability factors?

Yes

No

The Management Company has joined the Net Zero Asset Manager Initiative and considers PAI indicators through stewardship including engagement, both are relevant to mitigate potential adverse impact as a company.

Due to the commitment to the Net Zero Asset Manager Initiative, the Management Company aims to reduce greenhouse gas emissions in partnership with asset owner clients on decarbonisation goals, consistent with an ambition to reach net zero emission by 2050 or sooner across all assets under management. As part of this objective the Management Company will set an interim target for the proportion of assets to be managed in line with the attainment of net zero emissions by 2050 or sooner.

The Sub-Fund's Investment Manager considers PAI indicators regarding greenhouse gas emission, biodiversity, water, waste as well as social and employee matters for corporate issuers, and, where relevant, the freedom house index is applied to investments in sovereigns. PAI indicators are considered within the Investment Manager's investment process through the means of exclusions as described in the "binding elements" section of the Sub-Fund.

The data coverage for the data required for the PAI indicators is heterogenous. The data coverage related to biodiversity, water and waste is low and the related PAI indicators are considered through exclusion of securities issued by companies having a severe violation / breach of principles and guidelines such as the Principles of the United Nations Global Compact, the OECD Guidelines for Multinational Enterprises, and the United Nations Guiding Principles for Business and Human Rights on the grounds of problematic practices around human rights, labour rights, environment, and corruption issues. Therefore, the Investment Manager will strive to increase data coverage for PAI indicators with low data coverage. The Investment Manager will regularly evaluate whether the availability of data has increased sufficiently to potentially include assessment of such data in the investment process.

Additionally, PAI indicators are, among other sustainability factors, applied to derive the SRI Rating. The SRI Rating is used for the portfolio construction.

The following PAI indicators are considered:

Applicable to corporate issuers

- GHG Emissions
- Carbon footprint
- GHG Intensity of investee companies
- Exposure to companies active in the fossil fuel sector
- Activities negatively affecting biodiversity-sensitive areas
- Emissions to water
- Hazardous waste ratio

- Violation of UN Global compact principles
- Lack of processes and compliance mechanisms to monitor compliance with UN Global Compact principles
- Board gender diversity
- Exposure to controversial weapons

Applicable to sovereign and supranational issuers

- Investee countries subject to social violations

The information on the PAI indicators will be available in the end-year report of the Sub-Fund.



The investment strategy guides investment decisions based on factors such as investment objectives and risk tolerance.

What investment strategy does this financial product follow?

Allianz Climate Transition 's investment objective is to invest in European Equity markets with a focus on companies with an engagement in a transition into a low-carbon economy in accordance with the Sustainable and Responsible Investment Strategy (SRI Strategy).

As part of the SRI best-in-class approach, the Sub-Fund takes environmental, social, human rights, governance, and business behaviour factors into account as follows:

- The aforesaid sustainability factors are analysed through SRI Research by the Investment Manager in order to assess how sustainable development and long-term issues are taken into account in the strategy of an issuer. SRI Research means the overall process of identifying potential risks as well as potential opportunities of an investment in securities of an issuer related to the analysis of sustainability factors. SRI Research data combines external research data (which might have some limitations) with internal analyses.
- Based on a combination of the results of the external and/or internal analyses of the sustainability factors, an internal rating is derived monthly (SRI Rating) and is afterwards assigned to a corporate or sovereign issuer.

This internal SRI Rating is used to rank and select or weight securities for the portfolio construction.

The Sub-Fund's general investment approach (Sub-Fund's applicable General Asset Class Principles in combination with its individual investment restrictions) is described in the prospectus.

● What are the binding elements of the investment strategy used to select the investments to attain each of the environmental or social characteristics promoted by this financial product?

The binding elements are:

- Minimum rating coverage: At least 90% of Sub-Fund's portfolio is required to have an SRI Rating (Portfolio in this respect does not comprise non-rated derivatives and instruments that are non-rated by nature e.g., cash and deposits). While most holdings of Sub-Funds will have a corresponding SRI Rating some investments cannot be rated according to the SRI Research methodology. Examples of instruments not attaining to the SRI Rating include, but are not limited to, cash, deposits, Target Funds and non-rated investments.
- 90% of the rated instruments are adhering to the minimum rating threshold of 2 (out of a rating scale from 0 – 4; 0 being the worst rating and 4 the best rating), and 10% are adhering to a rating threshold between 1,5 and 2.
- Reduction of investment universe by excluding at least 20% of issuers.
- Application of the following sustainable minimum exclusion criteria for direct investments:
 - securities issued by companies having a severe violation / breach of principles and guidelines such as the Principles of the United Nations Global Compact, the OECD Guidelines for Multinational Enterprises, and the United Nations Guiding Principles for Business and Human Rights on the grounds of problematic practices around human rights, labour rights, environment, and corruption issues,
 - securities issued by companies involved in controversial weapons (anti-personnel mines, cluster munitions, chemical weapons, biological weapons, depleted uranium, white phosphorus, and nuclear weapons),
 - securities issued by companies that derive more than 10% of their revenues from weapons, military equipment, and services,

- securities issued by companies that derive more than 10% of their revenue from thermal coal extraction,
- securities issued by utility companies that generate more than 20% of their revenues from coal,
- securities issued by companies involved in the production of tobacco, and securities issued by companies involved in the distribution of tobacco with more than 5% of their revenues.

Direct investments in sovereign issuers with an insufficient freedom house index score are excluded.

The sustainable minimum exclusion criteria are based on information from an external data provider and coded in pre- and post-trade compliance. The review is performed at least half yearly.

● **What is the committed minimum rate to reduce the scope of the investments considered prior to the application of that investment strategy?**

The Sub-Fund commits to reduce the investment universe by at least 20%.

● **What is the policy to assess good governance practices of the investee companies?**

Good governance principles are considered by screening out companies based on their involvement in controversies around international norms corresponding to the four good governance practices: sound management structures, employee relations, remuneration of staff and tax compliance. Companies having a severe violation in either of those areas will not be investible. For certain cases, flagged issuers shall be on a watch list. These companies will appear on this watch list when the Investment Manager believes that engagement may lead to improvements or when the company is assessed to take remedial actions. Companies on the watch list remain investible unless the Investment Manager believes that the engagement or the remedial actions of the company does not lead to the desired remedy of the severe controversy.

In addition, the Sub-Fund's Investment Manager is committed to actively encourage open dialogues with investee companies on corporate governance, proxy voting and broader sustainability issues in advance of shareholder meetings (regularly for direct investments in shares). The Sub-Fund's Investment Manager's approach to proxy voting and company engagement is set out in the Management Company's Stewardship Statement.

Good governance practices include sound management structures, employee relations, remuneration of staff and tax compliance.



What is the asset allocation planned for this financial product?

Asset allocation describes the share of investments in specific assets.

Min. 90% of the Sub-Funds' assets (excluding cash and non-rated derivatives) are used to meet the environmental or social characteristics promoted by this Sub-Fund. A low portion of the Sub-Fund might contain assets which do not promote environmental or social characteristics. Examples of such instruments are derivatives, cash and deposits, some Target Funds and investment with temporarily divergent or absent environmental, social, or good governance qualifications. Min. 15% of the Sub-Funds' assets will be invested in Sustainable Investments. The minimum percentage of investments that are aligned with the EU Taxonomy is 0.01%. The Sub-Fund's Investment Manager does not commit to a minimum share of environmentally Sustainable Investments that are not aligned with the EU Taxonomy. The Sub-Fund's Investment Manager does not commit to a minimum share of socially sustainable investments. While the Sub-Fund cannot commit to a minimum share of environmentally or socially sustainable investments, such investments may be freely allocated to within the Sub-Fund aggregated sustainable investment commitment disclosed (min. 15%).

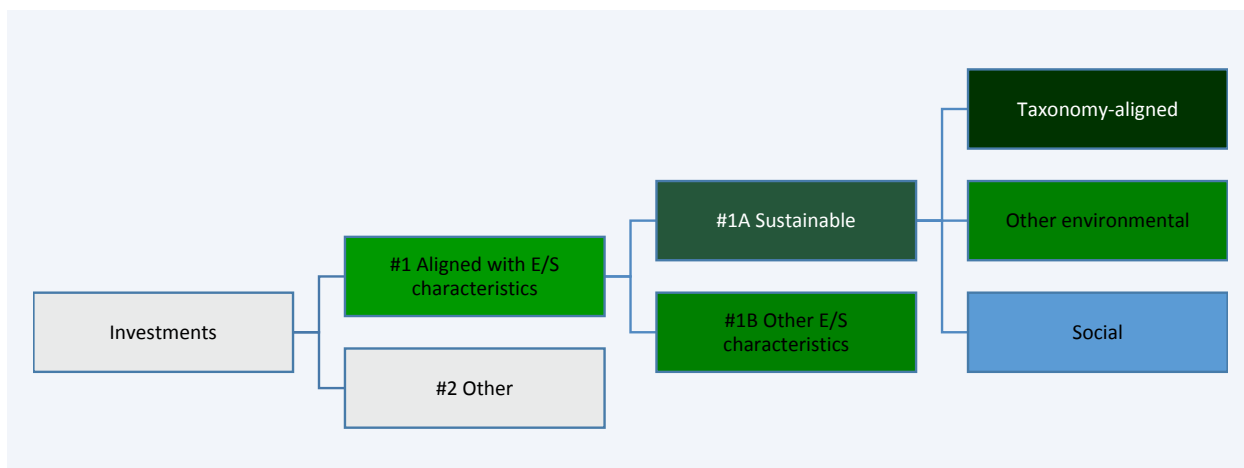

#1 Aligned with E/S characteristics includes the investments of the financial product used to attain the environmental or social characteristics promoted by the financial product.

#2 Other includes the remaining investments of the financial product which are neither aligned with the environmental or social characteristics, nor are qualified as sustainable investments.

The category **#1 Aligned with E/S characteristics** covers:

- The sub-category **#1A Sustainable** covers sustainable investments with environmental or social objectives.
- The sub-category **#1B Other E/S characteristics** covers investments aligned with the environmental or social characteristics that do not qualify as sustainable investments.

● **How does the use of derivatives attain the environmental or social characteristics promoted by the financial product?**

Not applicable



To what minimum extent are sustainable investments with an environmental objective aligned with the EU Taxonomy?

The Taxonomy-aligned investments include debt and/or equity in environmentally sustainable economic activities aligned with the EU-Taxonomy. The minimum percentage of investments that are aligned with the EU Taxonomy is 0.01%. Taxonomy-aligned data is provided by an external data provider. The Investment Manager has assessed the quality of such data. The data will not be subject to an assurance provided by auditors or a review by third parties. The data will not reflect any data in government bonds. As of today, there is no recognized methodology available to determine the proportion of Taxonomy-aligned activities when investing in government bonds.

Taxonomy-aligned activities in this disclosure are based on share of turnover. Pre-contractual figures use turnover as its financial metric as a default in line with the regulatory requirements and based on the fact that complete, verifiable or up-to date data for CAPEX and/or OPEX as financial metric is even less available.

Taxonomy-aligned data is only in rare cases data reported by companies in accordance with the EU Taxonomy. The data provider has derived Taxonomy-aligned data from other available equivalent public data.

● **Does the financial product invest in fossil gas and/or nuclear energy related activities that comply with the EU Taxonomy ¹?**

- Yes:
 - In fossil gas
 - In nuclear energy
- No

The Sub-Fund does not pursue any investments in fossil gas and/or nuclear energy related activities that comply with the EU Taxonomy. Nevertheless, as result of this investment strategy, investments may occur in corporates which are also active in these activities. Further information will be provided as part of the annual reporting, if relevant.

Taxonomy-aligned activities are expressed as a share of:
 - **turnover** reflecting the share of revenue from green activities of investee companies
 - **capital expenditure (CapEx)** showing the green investments made by investee companies, e.g. for a transition to a green

¹ Fossil gas and/or nuclear related activities will only comply with the EU Taxonomy where they contribute to limiting climate change ("climate change mitigation") and do not significantly harm any EU Taxonomy objective - see explanatory note in the left hand margin. The full criteria for fossil gas and nuclear energy economic activities that comply with the EU Taxonomy are laid down in Commission Delegated Regulation (EU) 2022/1214.

economy.
 - **operational expenditure (OpEx)** reflecting green operational activities of investee companies.

The two graphs below show in green the minimum percentage of investments that are aligned with the EU Taxonomy. As there is no appropriate methodology to determine the Taxonomy-alignment of sovereign bonds*, the first graph shows the Taxonomy-alignment in relation to all the investments of the financial product including sovereign bonds, while the second graph shows the Taxonomy-alignment only in relation to the investments of the financial product other than sovereign bonds.

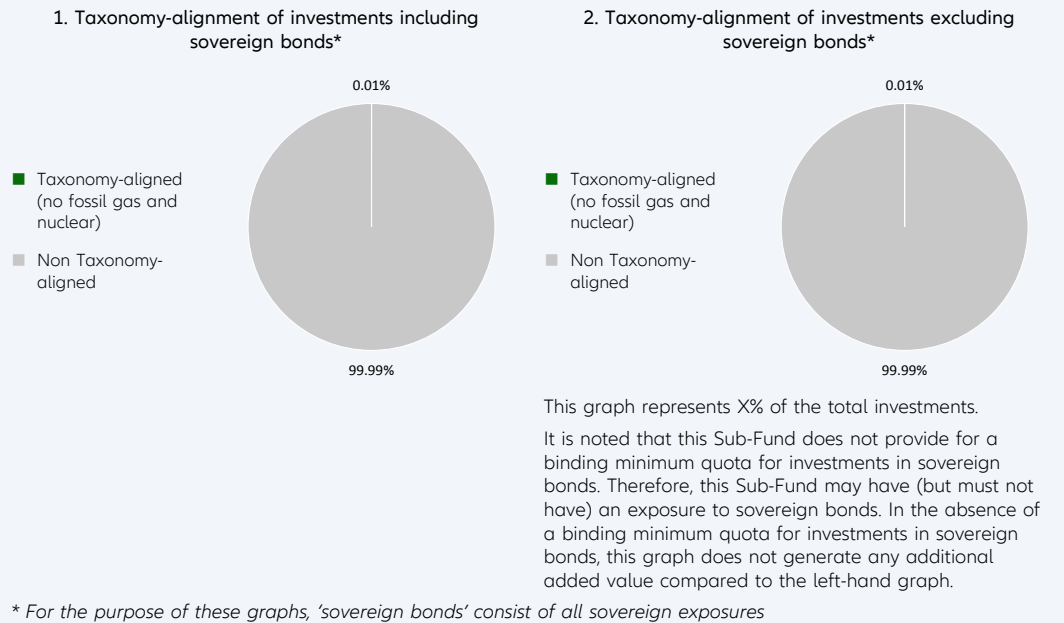

Enabling activities directly enable other activities to make a substantial contribution to an environmental objective.

Transitional activities are activities for which low-carbon alternatives are not yet available and among others have greenhouse gas emission levels corresponding to the best performance.

● **What is the minimum share of investments in transitional and enabling activities?**

The Sub-Fund's Investment Manager does not commit to a split of minimum taxonomy alignment into transitional, enabling activities and own performance.



What is the minimum share of sustainable investments with an environmental objective that are not aligned with the EU Taxonomy?

Taxonomy-aligned investments are considered a sub-category of Sustainable Investments. If an investment is not Taxonomy-aligned since the activity is not yet covered under the EU Taxonomy or the positive contribution is not substantial enough to comply with the Taxonomy technical screening criteria, the investment can still be considered an environmentally Sustainable Investment provided it complies with all criteria. The Investment Manager does not commit to a minimum share of environmentally Sustainable Investments that are not aligned with the EU Taxonomy. The overall sustainable investment share may also include investments with an environmental objective in economic activities that do not qualify as environmentally sustainable under the EU Taxonomy, and while the Sub-Fund cannot commit to a minimum share of environmentally or socially sustainable investments, such investments may be freely allocated to within the Sub-Fund aggregated sustainable investment commitment disclosed (min. 15%).

are sustainable investments with an environmental objective that **do not take into account the criteria** for environmentally sustainable economic activities under the EU Taxonomy.



What is the minimum share of socially sustainable investments?

The Investment Manager defines Sustainable Investments based on internal research, which uses, among others, the UN Sustainable Development Goals (SDGs), as well as the objectives of the EU Taxonomy as reference frameworks. The Investment Manager does not commit to a minimum share of socially Sustainable Investments, as the SDGs contain environmental as well as social objectives. The overall sustainable investment share may also include investments with a social objective, and while the Sub-Fund cannot commit to a minimum share of environmentally or socially sustainable investments, such investments may be freely allocated to within the Sub-Fund aggregated sustainable investment commitment disclosed (min. 15%).



What investments are included under “#2 Other”, what is their purpose and are there any minimum environmental or social safeguards?

Under “#2 Other” investments into cash, Target Funds, or derivatives can be included. Derivatives might be used for efficient portfolio management (including risk hedging) and/or investment purposes, and Target Funds to benefit from a specific strategy. For those investments no environmental or social safeguards are applied.



Is a specific index designated as a reference benchmark to determine whether this financial product is aligned with the environmental and/or social characteristics that it promotes?

No reference benchmark has been designated for the purpose of attaining the environmental and/or social characteristics promoted by the Sub-Fund.

- How is the reference benchmark continuously aligned with each of the environmental or social characteristics promoted by the financial product?

Not applicable

- How is the alignment of the investment strategy with the methodology of the index ensured on a continuous basis?

Not applicable

- How does the designated index differ from a relevant broad market index?

Not applicable

- Where can the methodology used for the calculation of the designated index be found?

Not applicable

Reference benchmarks are indexes to measure whether the financial product attains the environmental or social characteristics that they promote.



Where can I find more product specific information online?

More product-specific information can be found on the website: <https://regulatory.allianzgi.com/SFDR>

Template pre-contractual disclosure for the financial products referred to in Article 8, paragraphs 1, 2 and 2a, of Regulation (EU) 2019/2088 and Article 6, first paragraph, of Regulation (EU) 2020/852

Product name:

Allianz Convertible Bond

Legal entity identifier: 5299001GCNUJ1XFXOL76

Environmental and/or social characteristics

Sustainable investment means an investment in an economic activity that contributes to an environmental or social objective, provided that the investment does not significantly harm any environmental or social objective and that the investee companies follow good governance practices.

The EU Taxonomy is a classification system laid down in Regulation (EU) 2020/852, establishing a list of **environmentally sustainable economic activities**. That Regulation does not include a list of socially sustainable economic activities. Sustainable investments with an environmental objective might be aligned with the Taxonomy or not.

Does this financial product have a sustainable investment objective?	
Yes	No
<input type="checkbox"/> It will make a minimum of sustainable investments with an environmental objective : ___% <ul style="list-style-type: none"> <input type="checkbox"/> in economic activities that qualify as environmentally sustainable under the EU Taxonomy <input type="checkbox"/> in economic activities that do not qualify as environmentally sustainable under the EU Taxonomy 	<input type="checkbox"/> It promotes Environmental/Social (E/S) characteristics and while it does not have as its objective a sustainable investment, it will have a minimum proportion of ___% of sustainable investments <ul style="list-style-type: none"> <input type="checkbox"/> with an environmental objective in economic activities that qualify as environmentally sustainable under the EU Taxonomy <input type="checkbox"/> with an environmental objective in economic activities that do not qualify as environmentally sustainable under the EU Taxonomy <input type="checkbox"/> with a social objective
<input type="checkbox"/> It will make a minimum of sustainable investments with a social objective ___%	<input checked="" type="checkbox"/> It promotes E/S characteristics, but will not make any sustainable investments



What environmental and/or social characteristics are promoted by this financial product?

Allianz Convertible Bond (the "Sub-Fund") is managed according to the Sustainability Key Performance Indicator Strategy (Relative) ("KPI Strategy (Relative)") which addresses greenhouse gas (GHG) Intensity. The "Sustainability KPI" measures the GHG Intensity defined by the weighted average intensity of greenhouse gas emissions based on company's annual sales ("GHG Intensity").

GHG Intensity will be addressed by outperforming the Weighted Average GHG Intensity against its benchmark.

In addition, sustainable minimum exclusion criteria apply.

A reference benchmark has been designated for the purpose of attaining the environmental and/or social characteristics promoted by the Sub-Fund.

● What sustainability indicators are used to measure the attainment of each of the environmental or social characteristics promoted by this financial product?

To measure the attainment of the environmental and/or social characteristics the following sustainability indicators are used and reported on, at the fiscal year end:

- The actual percentage of KPI coverage of the Sub-Fund's Portfolio (Portfolio in this respect does not comprise derivatives and instruments that are non-evaluated by nature (e. g., cash and deposits)).
- The actual weighted average GHG Intensity portfolio vs weighted average GHG Intensity of the benchmark.

Sustainability indicators measure how the environmental or social characteristics promoted by the financial product are attained.

- Confirmation that Principal Adverse Impacts (PAIs) of investment decisions on sustainability factors are considered through the application of exclusion criteria.

- **What are the objectives of the sustainable investments that the financial product partially intends to make and how does the sustainable investment contribute to such objectives?**

Not applicable

- **How do the sustainable investments that the financial product partially intends to make, not cause significant harm to any environmental or social sustainable investment objective?**

Not applicable

- *How have the indicators for adverse impacts on sustainability factors been taken into account?*

Not applicable

- *How are the sustainable investments aligned with the OECD Guidelines for Multinational Enterprises and the UN Guiding Principles on Business and Human Rights? Details:*

Not applicable

Principal adverse impacts are the most significant negative impacts of investment decisions on sustainability factors relating to environmental, social and employee matters, respect for human rights, anti-corruption and anti-bribery matters.



Does this financial product consider principal adverse impacts on sustainability factors?

Yes

No

The Management Company has joined the Net Zero Asset Manager Initiative and considers PAI indicators through stewardship including engagement, both are relevant to mitigate potential adverse impact as a company.

Due to the commitment to the Net Zero Asset Manager Initiative, the Management Company aims to reduce greenhouse gas emissions in partnership with asset owner clients on decarbonisation goals, consistent with an ambition to reach net zero emission by 2050 or sooner across all assets under management. As part of this objective the Management Company will set an interim target for the proportion of assets to be managed in line with the attainment of net zero emissions by 2050 or sooner.

The Sub-Fund's Investment Manager addresses PAI indicators regarding greenhouse gas emission, biodiversity, water, waste as well as social and employee matters for corporate issuers, and, where relevant, the freedom house index is applied to investments in sovereigns. PAI indicators are considered within the Investment Manager's investment process through the means of exclusions as described in the "binding elements" section of the Sub-Fund.

The data coverage for the data required for the PAI indicators is heterogenous. The data coverage related to biodiversity, water and waste is low and the related PAI indicators are considered through exclusion of securities issued by companies having a severe violation / breach of principles and guidelines such as the Principles of the United Nations Global Compact, the OECD Guidelines for Multinational Enterprises, and the United Nations Guiding Principles for Business and Human Rights on the grounds of problematic practices around human rights, labour rights, environment, and corruption issues. Therefore, the Investment Manager will strive to increase data coverage for PAI indicators with low data coverage. The Investment Manager will regularly evaluate whether the availability of data has increased sufficiently to potentially include assessment of such data in the investment process.

Additionally, the Investment manager considers GHG related PAI indicators by outperforming the Weighted Average GHG Intensity against its benchmark. The following PAI indicators are considered:

Applicable to corporate issuers

- GHG Emissions
- Carbon footprint
- GHG Intensity of investee companies
- Exposure to companies active in the fossil fuel sector
- Activities negatively affecting biodiversity-sensitive areas
- Emissions to water
- Hazardous waste ratio
- Violation of UN Global compact principles
- Lack of processes and compliance mechanisms to monitor compliance with UN Global Compact principles
- Board gender diversity
- Exposure to controversial weapons

Applicable to sovereign and supranational issuers

- Investee countries subject to social violations

The information on the PAI indicators will be available in the end-year report of the Sub-Fund.



What investment strategy does this financial product follow?

The investment strategy guides investment decisions based on factors such as investment objectives and risk tolerance.

Allianz Convertible Bond's investment objective is to invest in convertible debt securities of European Bond Markets in accordance with the Sustainability Key Performance Indicator Strategy (Relative) ("KPI Strategy (Relative)").

The Sub-Fund's strategy is to outperform the Weighted Average GHG Intensity against its benchmark. The outperformance is determined as the excess between the Sub-Fund's weighted average GHG Intensity and the Sub-Fund's benchmark Weighted Average GHG Intensity.

The weighted average GHG Intensity is the weighted average of the Sub-Fund's GHG Intensity (in tCO₂e per Millions of sales). Sales represent company's annual sales. This ratio of GHG normalized by Sales facilitates comparison between companies of different sizes. The ratio is in tCO₂e per Millions of sales. The metric allows comparing weighted average GHG Intensities of different portfolios to identify portfolios comprised of more GHG-efficient issuers in terms of the issuer's sales. The portfolio weights (and benchmark or universe weights) are rebased such that only issuers with GHG emissions data available are considered in the calculation. GHG represents a respective issuer's greenhouse gas emissions. To determine the GHG Intensity of a company issuer, GHG Intensity data from third party data providers will be used. The GHG intensity is analysed by the Investment Manager and is considered within the securities selection process in order to meet the Sub-Fund Investment objective.

The proportion of assets which do not have a GHG intensity assessment is expected to be low. Examples of instruments not having a GHG intensity assessment are cash and deposits, some Target Funds, and investments for which the GHG intensity is deemed to be not appropriate and/or data is not available.

The Sub-Fund's general investment approach (Sub-Fund's applicable General Asset Class Principles in combination with its individual investment restrictions) is described in the prospectus.

● What are the binding elements of the investment strategy used to select the investments to attain each of the environmental or social characteristics promoted by this financial product?

The binding elements are:

- Min. 70% KPI coverage of the Sub-Fund's Portfolio (Portfolio in this respect does not comprise derivatives and instruments that are non-evaluated by nature (e. g., cash and deposits)).
- Outperformance of benchmark in terms of Weighted Average GHG Intensity.
- Application of the following sustainable minimum exclusion criteria for direct investments:
 - securities issued by companies having a severe violation / breach of principles and guidelines such as the Principles of the United Nations Global Compact, the OECD Guidelines for Multinational Enterprises, and the United Nations Guiding Principles for Business and Human Rights on the grounds of problematic practices around human rights, labour rights, environment, and corruption,

- securities issued by companies involved in controversial weapons (anti-personnel mines, cluster munitions, chemical weapons, biological weapons, depleted uranium, white phosphorus, and nuclear weapons),
- securities issued by companies that derive more than 10% of their revenues from weapons, military equipment, and services,
- securities issued by companies that derive more than 10% of their revenue from thermal coal extraction
- securities issued by utility companies that generate more than 20% of their revenues from coal,
- securities issued by companies involved in the production of tobacco, and securities issued by companies involved in the distribution of tobacco with more than 5% of their revenues.

Direct investments in sovereign issuers with an insufficient freedom house index score are excluded.

The sustainable minimum exclusion criteria are based on information from an external data provider and coded in pre- and post-trade compliance. The review is performed at least half yearly.

● **What is the committed minimum rate to reduce the scope of the investments considered prior to the application of that investment strategy?**

The Sub-Fund does not commit to reduce the scope of the investments by a certain minimum rate.

● **What is the policy to assess good governance practices of the investee companies?**

Good governance principles are considered by screening out companies based on their involvement in controversies around international norms corresponding to the four good governance practices: sound management structures, employee relations, remuneration of staff and tax compliance. Companies having a severe violation in either of those areas will not be investible. For certain cases, flagged issuers shall be on a watch list. These companies will appear on this watch list when the Investment Manager believes that engagement may lead to improvements or when the company is assessed to take remedial actions. Companies on the watch list remain investible unless the Investment Manager believes that the engagement or the remedial actions of the company does not lead to the desired remedy of the severe controversy.

In addition, the Sub-Fund's Investment Manager is committed to actively encourage open dialogues with investee companies on corporate governance, proxy voting and broader sustainability issues in advance of shareholder meetings (regularly for direct investments in shares). The Sub-Fund's Investment Manager's approach to proxy voting and company engagement is set out in the Management Company's Stewardship Statement.

Good governance practices include sound management structures, employee relations, remuneration of staff and tax compliance.



What is the asset allocation planned for this financial product?

Asset allocation describes the share of investments in specific assets.

Min. 70% of the Sub-Funds' assets (excluding cash, and derivatives) are used to meet the environmental or social characteristics promoted by this Sub-Fund. A low portion of the Sub-Fund might contain assets which do not promote environmental or social characteristics. Example of such instruments are derivatives, cash and deposits, some Target Funds and investment with temporarily divergent or absent environmental, social, or good governance qualifications.

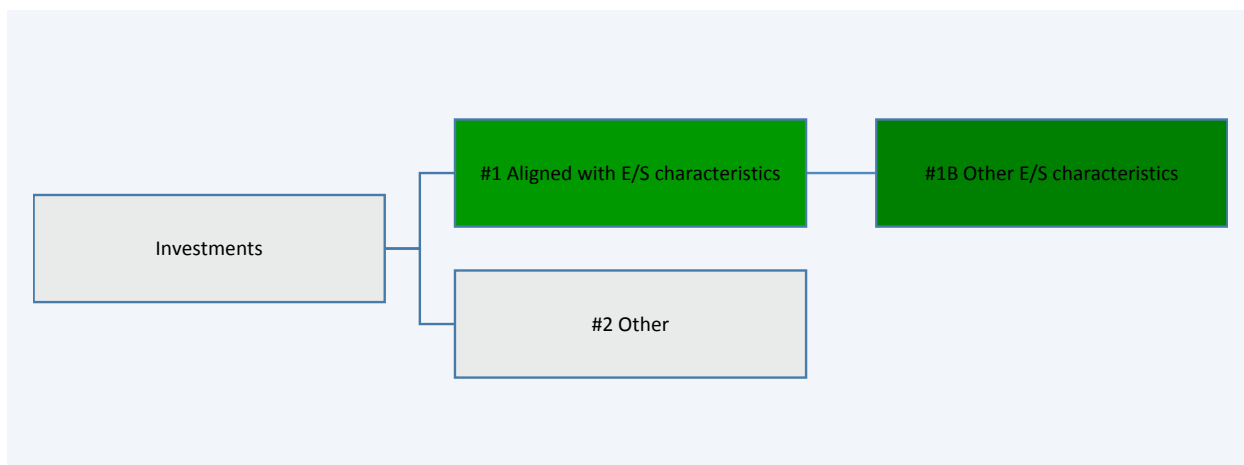

#1 Aligned with E/S characteristics includes the investments of the financial product used to attain the environmental or social characteristics promoted by the financial product.

#2 Other includes the remaining investments of the financial product which are neither aligned with the environmental or social characteristics, nor are qualified as sustainable investments.

The category **#1 Aligned with E/S characteristics** covers:

- The sub-category **#1A Sustainable** covers sustainable investments with environmental or social objectives.
- The sub-category **#1B Other E/S characteristics** covers investments aligned with the environmental or social characteristics that do not qualify as sustainable investments.

- **How does the use of derivatives attain the environmental or social characteristics promoted by the financial product?**

Not applicable



To what minimum extent are sustainable investments with an environmental objective aligned with the EU Taxonomy?

The Sub-Fund's Investment Manager does not commit to a minimum share of sustainable investments with an environmental objective aligned with the EU Taxonomy.

- **Does the financial product invest in fossil gas and/or nuclear energy related activities that comply with the EU Taxonomy¹?**

Yes:

In fossil gas In nuclear energy

No

Taxonomy-aligned activities are expressed as a share of:

- **turnover** reflecting the share of revenue from green activities of investee companies
- **capital expenditure** (CapEx) showing the green investments made by investee companies, e.g. for a transition to a green economy.
- **operational expenditure** (OpEx) reflecting green operational activities of investee companies.

¹ Fossil gas and/or nuclear related activities will only comply with the EU Taxonomy where they contribute to limiting climate change ("climate change mitigation") and do not significantly harm any EU Taxonomy objective - see explanatory note in the left hand margin. The full criteria for fossil gas and nuclear energy economic activities that comply with the EU Taxonomy are laid down in Commission Delegated Regulation (EU) 2022/1214.

The two graphs below show in green the minimum percentage of investments that are aligned with the EU Taxonomy. As there is no appropriate methodology to determine the Taxonomy-alignment of sovereign bonds*, the first graph shows the Taxonomy-alignment in relation to all the investments of the financial product including sovereign bonds, while the second graph shows the Taxonomy-alignment only in relation to the investments of the financial product other than sovereign bonds.

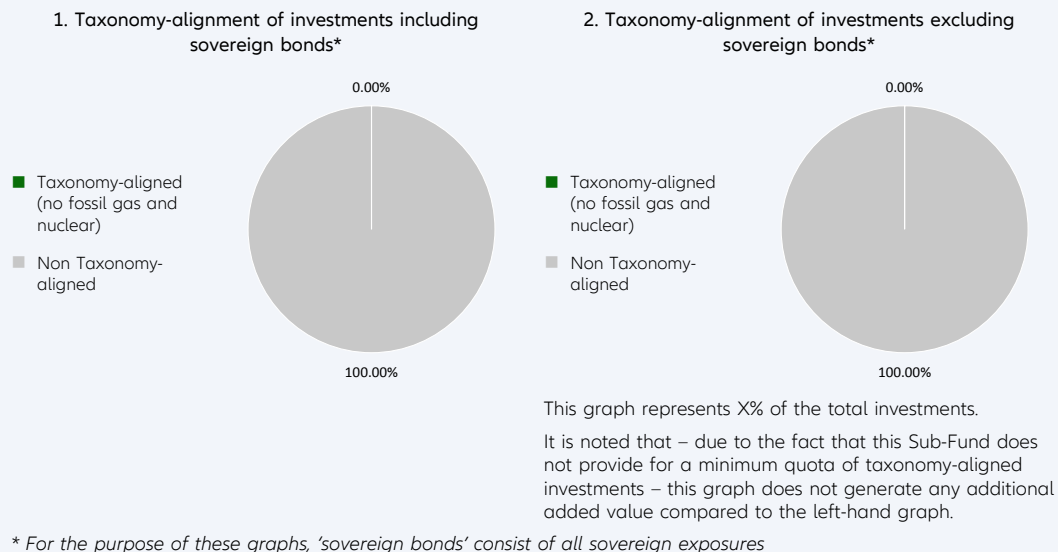

Enabling activities directly enable other activities to make a substantial contribution to an environmental objective.

Transitional activities are activities for which low-carbon alternatives are not yet available and among others have greenhouse gas emission levels corresponding to the best performance.

● **What is the minimum share of investments in transitional and enabling activities?**

The Sub-Fund’s Investment Manager does not commit to a split of minimum taxonomy alignment into transitional, enabling activities and own performance.



What is the minimum share of sustainable investments with an environmental objective that are not aligned with the EU Taxonomy?

The Sub-Fund’s Investment Manager does not commit to a minimum share of investments with an environmental objective that are not aligned with the EU Taxonomy.



are sustainable investments with an environmental objective that **do not take into account the criteria** for environmentally sustainable economic activities under the EU Taxonomy.



What is the minimum share of socially sustainable investments?

The Sub-Fund’s Investment Manager does not commit to a minimum share of socially sustainable investments.



What investments are included under “#2 Other”, what is their purpose and are there any minimum environmental or social safeguards?

Under “#2 Other” investments into cash, Target Funds, or derivatives can be included. Derivatives might be used for efficient portfolio management (including risk hedging) and/or investment purposes, and Target Funds to benefit from a specific strategy. For those investments no environmental or social safeguards are applied.



Is a specific index designated as a reference benchmark to determine whether this financial product is aligned with the environmental and/or social characteristics that it promotes?

Yes, the Sub-Fund has assigned the Refinitiv Europe Focus CB (EUR) as a benchmark. This benchmark is a market index. The Sub-Fund will promote environmental and social characteristics by outperforming the benchmark's Weighted Average GHG Intensity

Reference benchmarks are indexes to measure whether the financial product attains the environmental or social characteristics that they promote.

- **How is the reference benchmark continuously aligned with each of the environmental or social characteristics promoted by the financial product?**
The benchmark is a market index and does not incorporate environmental or social characteristics for index construction.
- **How is the alignment of the investment strategy with the methodology of the index ensured on a continuous basis?**
The benchmark is not continuously aligned as it does not incorporate environmental or social characteristics for index construction.
- **How does the designated index differ from a relevant broad market index?**
The benchmark is a broad market index.
- **Where can the methodology used for the calculation of the designated index be found?**
Details of the Benchmark's methodology may be found at <https://www.refinitiv.com/en/financial-data/indices/monthly-europe-focus-convertible-index>



Where can I find more product specific information online?

More product-specific information can be found on the website: <https://regulatory.allianzgi.com/SFDR>

Template pre-contractual disclosure for the financial products referred to in Article 8, paragraphs 1, 2 and 2a, of Regulation (EU) 2019/2088 and Article 6, first paragraph, of Regulation (EU) 2020/852

Product name:

Allianz Cyber Security

Legal entity identifier: 52990011GBTWP04NS84

Environmental and/or social characteristics

Sustainable investment means an investment in an economic activity that contributes to an environmental or social objective, provided that the investment does not significantly harm any environmental or social objective and that the investee companies follow good governance practices.

The EU Taxonomy is a classification system laid down in Regulation (EU) 2020/852, establishing a list of **environmentally sustainable economic activities**. That Regulation does not include a list of socially sustainable economic activities. Sustainable investments with an environmental objective might be aligned with the Taxonomy or not.

Does this financial product have a sustainable investment objective?	
<input checked="" type="radio"/> <input checked="" type="radio"/> Yes	<input checked="" type="radio"/> <input type="radio"/> No
<input type="checkbox"/> It will make a minimum of sustainable investments with an environmental objective: ___% <ul style="list-style-type: none"> <input type="checkbox"/> in economic activities that qualify as environmentally sustainable under the EU Taxonomy <input type="checkbox"/> in economic activities that do not qualify as environmentally sustainable under the EU Taxonomy 	<input checked="" type="checkbox"/> It promotes Environmental/Social (E/S) characteristics and while it does not have as its objective a sustainable investment, it will have a minimum proportion of 2.00% of sustainable investments <ul style="list-style-type: none"> <input checked="" type="checkbox"/> with an environmental objective in economic activities that qualify as environmentally sustainable under the EU Taxonomy <input checked="" type="checkbox"/> with an environmental objective in economic activities that do not qualify as environmentally sustainable under the EU Taxonomy <input checked="" type="checkbox"/> with a social objective
<input type="checkbox"/> It will make a minimum of sustainable investments with a social objective ___%	<input type="checkbox"/> It promotes E/S characteristics, but will not make any sustainable investments



What environmental and/or social characteristics are promoted by this financial product?

Allianz Cyber Security (the "Sub-Fund") is managed according to the Sustainability Key Performance Indicator Strategy (Relative) ("KPI Strategy (Relative)") which addresses greenhouse gas (GHG) Intensity. The "Sustainability KPI" measures the GHG Intensity defined by the weighted average intensity of greenhouse gas emissions based on company's annual sales ("GHG Intensity").

GHG Intensity will be addressed by outperforming the Weighted Average GHG Intensity against its benchmark.

In addition, sustainable minimum exclusion criteria apply.

A reference benchmark has been designated for the purpose of attaining the environmental and/or social characteristics promoted by the Sub-Fund.

● What sustainability indicators are used to measure the attainment of each of the environmental or social characteristics promoted by this financial product?

To measure the attainment of the environmental and/or social characteristics the following sustainability indicators are used and reported on, at the fiscal year end:

- The actual percentage of KPI coverage of the Sub-Fund's Portfolio (Portfolio in this respect does not comprise derivatives and instruments that are non-evaluated by nature (e. g., cash and deposits)).
- The actual weighted average GHG Intensity portfolio vs weighted average GHG Intensity of the benchmark.

Sustainability indicators measure how the environmental or social characteristics promoted by the financial product are attained.

- Confirmation that Principal Adverse Impacts (PAIs) of investment decisions on sustainability factors are considered through the application of exclusion criteria.

- **What are the objectives of the sustainable investments that the financial product partially intends to make and how does the sustainable investment contribute to such objectives?**

Sustainable investments contribute to environmental and/or social objectives, for which the Investment Manager uses as reference frameworks, among others, the UN Sustainable Development Goals (SDGs), as well as the objectives of the EU Taxonomy:

1. Climate Change Mitigation
2. Climate Change Adaptation
3. Sustainable Use and Protection of Water and Marine Resources
4. Transition to a Circular Economy
5. Pollution Prevention and Control
6. Protection and Restoration of Biodiversity and Ecosystems

The assessment of the positive contribution to the environmental or social objectives is based on a proprietary framework which combines quantitative elements with qualitative inputs from internal research. The methodology applies first a quantitative breakdown of a securities issuer into its business activities. The qualitative element of the framework is an assessment if business activities contribute positively to an environmental or a social objective.

To calculate the positive contribution on the Sub-Fund level the revenue share of each issuer attributable to business activities contributing to environmental and/or social objectives is considered provided the issuer is satisfying the Do No Significant Harm (“DNSH”) and Good Governance principles, and an asset-weighted aggregation is performed as a second step. Moreover, for certain types of securities, which finance specific projects contributing to environmental or social objectives the overall investment is considered to contribute to environmental and/or social objectives, but also for these a DNSH as well as a Good Governance check for issuers is performed.

- **How do the sustainable investments that the financial product partially intends to make, not cause significant harm to any environmental or social sustainable investment objective?**

In order to ensure that Sustainable Investments do not significantly harm any other environmental and/or social objective, the Investment Manager is leveraging the PAI indicators, whereby significance thresholds have been defined to identify significantly harmful issuers. Issuers not meeting the significance threshold can be engaged for a limited time period to remediate the adverse impact. Otherwise, if the issuer does not meet the defined significance thresholds twice subsequently or in case of a failed engagement, it does not pass the DNSH assessment. Investments in securities of issuers which do not pass the DNSH assessment are not counted as sustainable investments.

- *How have the indicators for adverse impacts on sustainability factors been taken into account?*

All mandatory PAI indicators are considered either as part of the application of the exclusion criteria or through thresholds on a sectorial or absolute basis. Significance thresholds have been defined and they refer to qualitative or quantitative criteria.

Recognizing the lack of data coverage for some of the PAI indicators equivalent data points are used to assess PAI indicators when applying the DNSH assessment, when relevant, for the following indicators for corporates: share of non-renewable energy consumption and production, activities negatively affecting biodiversity-sensitive areas, emissions to water, lack of processes and compliance mechanisms to monitor compliance with UNGC principles and OECD Guidelines for Multinational Enterprises; for sovereigns: GHG Intensity and investee countries subject to social violations. In case of securities which finance specific projects contributing to environmental or social objectives equivalent data at project level might be used to ensure that Sustainable Investments do not significantly harm any other environmental and/or social objective. The Investment Manager will strive to increase data coverage for PAI indicators with low data coverage by engaging with issuers and data providers. The Investment Manager will regularly evaluate whether the availability of data has increased sufficiently to potentially include assessment of such data in the investment process.

Principal adverse impacts are the most significant negative impacts of investment decisions on sustainability factors relating to environmental, social and employee matters, respect for human rights, anti-corruption and anti-bribery matters.

- *How are the sustainable investments aligned with the OECD Guidelines for Multinational Enterprises and the UN Guiding Principles on Business and Human Rights? Details:*

The Investment Manager's sustainable minimum exclusion list screens out companies based on their involvement in controversial practices against international norms. The core normative framework consists of the Principles of the UN Global Compact, the OECD Guidelines for Multinational Enterprises and the UN Guiding Principles for Business and Human Rights. Securities issued by companies having a severe violation of these frameworks will be restricted from the investment universe.

The EU Taxonomy sets out a "do not significant harm" principle by which Taxonomy-aligned investments should not significantly harm EU Taxonomy objectives and is accompanied by specific EU criteria.

The "do not significant harm" principle applies only to those investments underlying the financial product that take into account the EU criteria for environmentally sustainable economic activities. The investments underlying the remaining portion of this financial product do not take into account the EU criteria for environmentally sustainable economic activities.

Any other sustainable investments must also not significantly harm any environmental or social objectives.



Does this financial product consider principal adverse impacts on sustainability factors?

Yes

No

The Management Company has joined the Net Zero Asset Manager Initiative and considers PAI indicators through stewardship including engagement, both are relevant to mitigate potential adverse impact as a company.

Due to the commitment to the Net Zero Asset Manager Initiative, the Management Company aims to reduce greenhouse gas emissions in partnership with asset owner clients on decarbonisation goals, consistent with an ambition to reach net zero emission by 2050 or sooner across all assets under management. As part of this objective the Management Company will set an interim target for the proportion of assets to be managed in line with the attainment of net zero emissions by 2050 or sooner.

The Sub-Fund's Investment Manager addresses PAI indicators regarding greenhouse gas emission, biodiversity, water, waste as well as social and employee matters for corporate issuers, and, where relevant, the freedom house index is applied to investments in sovereigns. PAI indicators are considered within the Investment Manager's investment process through the means of exclusions as described in the "binding elements" section of the Sub-Fund.

The data coverage for the data required for the PAI indicators is heterogenous. The data coverage related to biodiversity, water and waste is low and the related PAI indicators are considered through exclusion of securities issued by companies having a severe violation / breach of principles and guidelines such as the Principles of the United Nations Global Compact, the OECD Guidelines for Multinational Enterprises, and the United Nations Guiding Principles for Business and Human Rights on the grounds of problematic practices around human rights, labour rights, environment, and corruption issues. Therefore, the Investment Manager will strive to increase data coverage for PAI indicators with low data coverage. The Investment Manager will regularly evaluate whether the availability of data has increased sufficiently to potentially include assessment of such data in the investment process.

Additionally, the Investment manager considers GHG related PAI indicators by outperforming the Weighted Average GHG Intensity against its benchmark. The following PAI indicators are considered:

Applicable to corporate issuers

- GHG Emissions
- Carbon footprint
- GHG Intensity of investee companies
- Exposure to companies active in the fossil fuel sector
- Activities negatively affecting biodiversity-sensitive areas
- Emissions to water
- Hazardous waste ratio
- Violation of UN Global compact principles

- Lack of processes and compliance mechanisms to monitor compliance with UN Global Compact principles
- Board gender diversity
- Exposure to controversial weapons

Applicable to sovereign and supranational issuers

- Investee countries subject to social violations

The information on the PAI indicators will be available in the end-year report of the Sub-Fund.



What investment strategy does this financial product follow?

The investment strategy guides investment decisions based on factors such as investment objectives and risk tolerance.

Allianz Cyber Security's investment objective is to invest in the global Equity Markets with a focus on companies whose business will benefit from or is currently related to cyber security in accordance with the Sustainability Key Performance Indicator Strategy (Relative) ("KPI Strategy (Relative)").

The Sub-Fund's strategy is to outperform the Weighted Average GHG Intensity against its benchmark. The outperformance is determined as the excess between the Sub-Fund's weighted average GHG Intensity and the Sub-Fund's benchmark Weighted Average GHG Intensity.

The weighted average GHG Intensity is the weighted average of the Sub-Fund's GHG Intensity (in tCO₂e per Millions of sales). Sales represent company's annual sales. This ratio of GHG normalized by Sales facilitates comparison between companies of different sizes. The ratio is in tCO₂e per Millions of sales. The metric allows comparing weighted average GHG Intensities of different portfolios to identify portfolios comprised of more GHG-efficient issuers in terms of the issuer's sales. The portfolio weights (and benchmark or universe weights) are rebased such that only issuers with GHG emissions data available are considered in the calculation. GHG represents a respective issuer's greenhouse gas emissions. To determine the GHG Intensity of a company issuer, GHG Intensity data from third party data providers will be used. The GHG intensity is analysed by the Investment Manager and is considered within the securities selection process in order to meet the Sub-Fund Investment objective.

The proportion of assets which do not have a GHG intensity assessment is expected to be low. Examples of instruments not having a GHG intensity assessment are cash and deposits, some Target Funds, and investments for which the GHG intensity is deemed to be not appropriate and/or data is not available.

The Sub-Fund's general investment approach (Sub-Fund's applicable General Asset Class Principles in combination with its individual investment restrictions) is described in the prospectus.

● What are the binding elements of the investment strategy used to select the investments to attain each of the environmental or social characteristics promoted by this financial product?

The binding elements are:

- Min. 80% KPI coverage of the Sub-Fund's Portfolio (Portfolio in this respect does not comprise derivatives and instruments that are non-evaluated by nature (e. g., cash and deposits)).
- Min. 20% outperformance of benchmark in terms of Weighted Average GHG Intensity.
- Application of the following sustainable minimum exclusion criteria for direct investments:
 - securities issued by companies having a severe violation / breach of principles and guidelines such as the Principles of the United Nations Global Compact, the OECD Guidelines for Multinational Enterprises, and the United Nations Guiding Principles for Business and Human Rights on the grounds of problematic practices around human rights, labour rights, environment, and corruption,
 - securities issued by companies involved in controversial weapons (anti-personnel mines, cluster munitions, chemical weapons, biological weapons, depleted uranium, white phosphorus, and nuclear weapons),
 - securities issued by companies that derive more than 10% of their revenues from weapons, military equipment, and services,
 - securities issued by companies that derive more than 10% of their revenue from thermal coal extraction
 - securities issued by utility companies that generate more than 20% of their revenues from coal,
 - securities issued by companies involved in the production of tobacco, and securities issued by companies involved in the distribution of tobacco with more than 5% of their revenues.

Direct investments in sovereign issuers with an insufficient freedom house index score are excluded.

The sustainable minimum exclusion criteria are based on information from an external data provider and coded in pre- and post-trade compliance. The review is performed at least half yearly.

- **What is the committed minimum rate to reduce the scope of the investments considered prior to the application of that investment strategy?**

The Sub-Fund does not commit to reduce the scope of the investments by a certain minimum rate.

- **What is the policy to assess good governance practices of the investee companies?**

Good governance principles are considered by screening out companies based on their involvement in controversies around international norms corresponding to the four good governance practices: sound management structures, employee relations, remuneration of staff and tax compliance. Companies having a severe violation in either of those areas will not be investible. For certain cases, flagged issuers shall be on a watch list. These companies will appear on this watch list when the Investment Manager believes that engagement may lead to improvements or when the company is assessed to take remedial actions. Companies on the watch list remain investible unless the Investment Manager believes that the engagement or the remedial actions of the company does not lead to the desired remedy of the severe controversy.

In addition, the Sub-Fund's Investment Manager is committed to actively encourage open dialogues with investee companies on corporate governance, proxy voting and broader sustainability issues in advance of shareholder meetings (regularly for direct investments in shares). The Sub-Fund's Investment Manager's approach to proxy voting and company engagement is set out in the Management Company's Stewardship Statement.

Good governance practices include sound management structures, employee relations, remuneration of staff and tax compliance.



What is the asset allocation planned for this financial product?

Asset allocation describes the share of investments in specific assets.

Min. 80% of the Sub-Funds' assets (excluding cash, and derivatives) are used to meet the environmental or social characteristics promoted by this Sub-Fund. A low portion of the Sub-Fund might contain assets which do not promote environmental or social characteristics. Example of such instruments are derivatives, cash and deposits, some Target Funds and investment with temporarily divergent or absent environmental, social, or good governance qualifications. Min. 2% of the Sub-Funds' assets will be invested in Sustainable Investments. The Sub-Fund's Investment Manager does not commit to a minimum share of sustainable investments with an environmental objective aligned with the EU Taxonomy nor to a minimum share of environmentally Sustainable Investments that are not aligned with the EU Taxonomy. The Sub-Fund's Investment Manager does not commit to a minimum share of socially sustainable investments. While the Sub-Fund cannot commit to a minimum share of environmentally or socially sustainable investments, such investments may be freely allocated to within the Sub-Fund aggregated sustainable investment commitment disclosed (min. 2%).

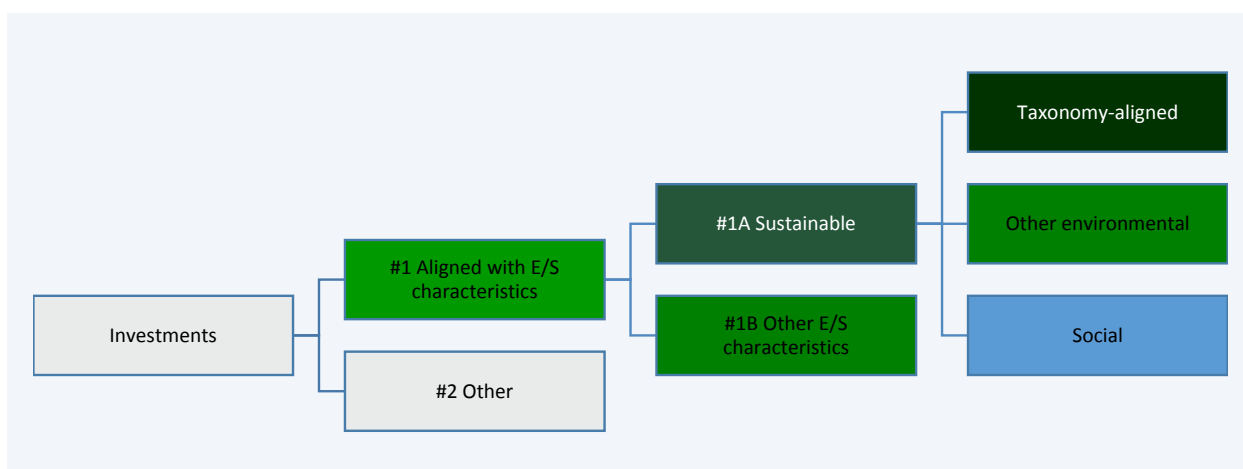

#1 Aligned with E/S characteristics includes the investments of the financial product used to attain the environmental or social characteristics promoted by the financial product.

#2 Other includes the remaining investments of the financial product which are neither aligned with the environmental or social characteristics, nor are qualified as sustainable investments.

The category **#1 Aligned with E/S characteristics** covers:

- The sub-category **#1A Sustainable** covers sustainable investments with environmental or social objectives.

- The sub-category #1B Other E/S characteristics covers investments aligned with the environmental or social characteristics that do not qualify as sustainable investments.

● **How does the use of derivatives attain the environmental or social characteristics promoted by the financial product?**

Not applicable



To what minimum extent are sustainable investments with an environmental objective aligned with the EU Taxonomy?

The Sub-Fund’s Investment Manager does not commit to a minimum share of sustainable investments with an environmental objective aligned with the EU Taxonomy. The overall sustainable investment share may also include investments with an environmental objective in economic activities that qualify as environmentally sustainable under the EU Taxonomy.

● **Does the financial product invest in fossil gas and/or nuclear energy related activities that comply with the EU Taxonomy ¹?**

- Yes:
 - In fossil gas
 - In nuclear energy
- No

The Sub-Fund does not pursue any investments in fossil gas and/or nuclear energy related activities that comply with the EU Taxonomy. Nevertheless, as result of this investment strategy, investments may occur in corporates which are also active in these activities. Further information will be provided as part of the annual reporting, if relevant.

The two graphs below show in green the minimum percentage of investments that are aligned with the EU Taxonomy. As there is no appropriate methodology to determine the Taxonomy-alignment of sovereign bonds, the first graph shows the Taxonomy-alignment in relation to all the investments of the financial product including sovereign bonds, while the second graph shows the Taxonomy-alignment only in relation to the investments of the financial product other than sovereign bonds.*

1. Taxonomy-alignment of investments including sovereign bonds*

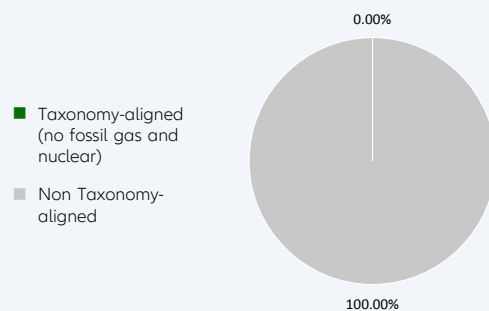

2. Taxonomy-alignment of investments excluding sovereign bonds*

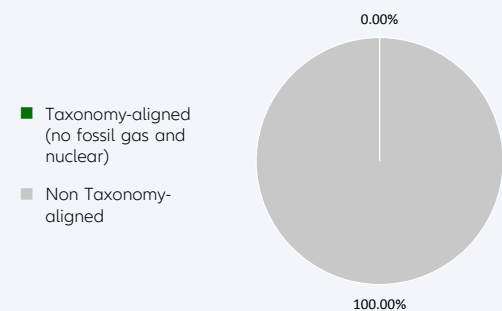

This graph represents X% of the total investments. It is noted that – due to the fact that this Sub-Fund does not provide for a minimum quota of taxonomy-aligned investments – this graph does not generate any additional added value compared to the left-hand graph.

* For the purpose of these graphs, ‘sovereign bonds’ consist of all sovereign exposures

● **What is the minimum share of investments in transitional and enabling activities?**

The Sub-Fund’s Investment Manager does not commit to a split of minimum taxonomy alignment into transitional, enabling activities and own performance.

Taxonomy-aligned activities are expressed as a share of:

- **turnover** reflecting the share of revenue from green activities of investee companies
- **capital expenditure (CapEx)** showing the green investments made by investee companies, e.g. for a transition to a green economy.
- **operational expenditure (OpEx)** reflecting green operational activities of investee companies.

Enabling activities directly enable other activities to make a substantial contribution to an environmental objective.

¹ Fossil gas and/or nuclear related activities will only comply with the EU Taxonomy where they contribute to limiting climate change (“climate change mitigation”) and do not significantly harm any EU Taxonomy objective - see explanatory note in the left hand margin. The full criteria for fossil gas and nuclear energy economic activities that comply with the EU Taxonomy are laid down in Commission Delegated Regulation (EU) 2022/1214.

Transitional activities are activities for which low-carbon alternatives are not yet available and among others have greenhouse gas emission levels corresponding to the best performance.



What is the minimum share of sustainable investments with an environmental objective that are not aligned with the EU Taxonomy?

Taxonomy-aligned investments are considered a sub-category of Sustainable Investments. If an investment is not Taxonomy-aligned since the activity is not yet covered under the EU Taxonomy or the positive contribution is not substantial enough to comply with the Taxonomy technical screening criteria, the investment can still be considered an environmentally Sustainable Investment provided it complies with all criteria. The Investment Manager does not commit to a minimum share of environmentally Sustainable Investments that are not aligned with the EU Taxonomy. The overall sustainable investment share may also include investments with an environmental objective in economic activities that do not qualify as environmentally sustainable under the EU Taxonomy, and while the Sub-Fund cannot commit to a minimum share of environmentally or socially sustainable investments, such investments may be freely allocated to within the Sub-Fund aggregated sustainable investment commitment disclosed (min. 2%).



are sustainable investments with an environmental objective that **do not take into account the criteria** for environmentally sustainable economic activities under the EU Taxonomy.



What is the minimum share of socially sustainable investments?

The Investment Manager defines Sustainable Investments based on internal research, which uses, among others, the UN Sustainable Development Goals (SDGs), as well as the objectives of the EU Taxonomy as reference frameworks. The Investment Manager does not commit to a minimum share of socially Sustainable Investments, as the SDGs contain environmental as well as social objectives. The overall sustainable investment share may also include investments with a social objective, and while the Sub-Fund cannot commit to a minimum share of environmentally or socially sustainable investments, such investments may be freely allocated to within the Sub-Fund aggregated sustainable investment commitment disclosed (min. 2%).



What investments are included under “#2 Other”, what is their purpose and are there any minimum environmental or social safeguards?

Under “#2 Other” investments into cash, Target Funds, or derivatives can be included. Derivatives might be used for efficient portfolio management (including risk hedging) and/or investment purposes, and Target Funds to benefit from a specific strategy. For those investments no environmental or social safeguards are applied.



Is a specific index designated as a reference benchmark to determine whether this financial product is aligned with the environmental and/or social characteristics that it promotes?

Yes, the Sub-Fund has assigned the MSCI AC World (ACWI) Information Technology Total Return Net as a benchmark. This benchmark is a market index. The Sub-Fund will promote environmental and social characteristics by outperforming the benchmark's Weighted Average GHG Intensity

● How is the reference benchmark continuously aligned with each of the environmental or social characteristics promoted by the financial product?

The benchmark is a market index and does not incorporate environmental or social characteristics for index construction.

Reference benchmarks are indexes to measure whether the financial product attains the environmental or social characteristics that they promote.

- **How is the alignment of the investment strategy with the methodology of the index ensured on a continuous basis?**

The benchmark is not continuously aligned as it does not incorporate environmental or social characteristics for index construction.

- **How does the designated index differ from a relevant broad market index?**

The benchmark is a broad market index.

- **Where can the methodology used for the calculation of the designated index be found?**

Details of the Benchmark's methodology may be found at <https://www.msci.com/documents/10199/69aaf9fd-d91d-4505-a877-4b1ad70ee855> or at www.msci.com



Where can I find more product specific information online?

More product-specific information can be found on the website: <https://regulatory.allianzgi.com/SFDR>

Template pre-contractual disclosure for the financial products referred to in Article 8, paragraphs 1, 2 and 2a, of Regulation (EU) 2019/2088 and Article 6, first paragraph, of Regulation (EU) 2020/852

Product name:

Allianz Dynamic Multi Asset Strategy SRI 15

Legal entity identifier: 549300PQDMLKLFQGT068

Environmental and/or social characteristics

Sustainable investment means an investment in an economic activity that contributes to an environmental or social objective, provided that the investment does not significantly harm any environmental or social objective and that the investee companies follow good governance practices.

The **EU Taxonomy** is a classification system laid down in Regulation (EU) 2020/852, establishing a list of **environmentally sustainable economic activities**. That Regulation does not include a list of socially sustainable economic activities. Sustainable investments with an environmental objective might be aligned with the Taxonomy or not.

Does this financial product have a sustainable investment objective?	
Yes	No
<input type="checkbox"/> It will make a minimum of sustainable investments with an environmental objective : ____% <input type="checkbox"/> in economic activities that qualify as environmentally sustainable under the EU Taxonomy <input type="checkbox"/> in economic activities that do not qualify as environmentally sustainable under the EU Taxonomy	<input checked="" type="checkbox"/> It promotes Environmental/Social (E/S) characteristics and while it does not have as its objective a sustainable investment, it will have a minimum proportion of 1.00% of sustainable investments <input checked="" type="checkbox"/> with an environmental objective in economic activities that qualify as environmentally sustainable under the EU Taxonomy <input checked="" type="checkbox"/> with an environmental objective in economic activities that do not qualify as environmentally sustainable under the EU Taxonomy <input checked="" type="checkbox"/> with a social objective
<input type="checkbox"/> It will make a minimum of sustainable investments with a social objective ____%	<input type="checkbox"/> It promotes E/S characteristics, but will not make any sustainable investments



What environmental and/or social characteristics are promoted by this financial product?

Allianz Dynamic Multi Asset Strategy SRI 15 (the "Sub-Fund") promotes environmental, social, human rights, governance, and business behaviour factors (this domain does not apply for sovereigns issued by a Sovereign Entity) through integration of a best-in-class approach into the Sub-Fund's investment process. This encompasses the evaluation of corporate or sovereign issuers based on an SRI Rating which is used to construct the portfolio.

In addition, sustainable minimum exclusion criteria apply.

No reference benchmark has been designated for the purpose of attaining the environmental and/or social characteristics promoted by the Sub-Fund.

What sustainability indicators are used to measure the attainment of each of the environmental or social characteristics promoted by this financial product?

To measure the attainment of the environmental and/or social characteristics the following sustainability indicators are used and reported on, at the fiscal year end:

- The actual percentage of the Sub-Fund's Portfolio (Portfolio in this respect does not comprise non-rated derivatives and instruments that are non-rated by nature (e. g., cash and deposits)) assets invested in best-in-class issuers (issuers with a minimum SRI Rating of 1 out of a scale from 0-4; 0 being the worst rating and 4 the best rating).
- Confirmation that Principal Adverse Impacts (PAIs) of investment decisions on sustainability factors are considered through the application of exclusion criteria.

Sustainability indicators measure how the environmental or social characteristics promoted by the financial product are attained.

● **What are the objectives of the sustainable investments that the financial product partially intends to make and how does the sustainable investment contribute to such objectives?**

Sustainable investments contribute to environmental and/or social objectives, for which the Investment Manager uses as reference frameworks, among others, the UN Sustainable Development Goals (SDGs), as well as the objectives of the EU Taxonomy:

1. Climate Change Mitigation
2. Climate Change Adaptation
3. Sustainable Use and Protection of Water and Marine Resources
4. Transition to a Circular Economy
5. Pollution Prevention and Control
6. Protection and Restoration of Biodiversity and Ecosystems

The assessment of the positive contribution to the environmental or social objectives is based on a proprietary framework which combines quantitative elements with qualitative inputs from internal research. The methodology applies first a quantitative breakdown of a securities issuer into its business activities. The qualitative element of the framework is an assessment if business activities contribute positively to an environmental or a social objective.

To calculate the positive contribution on the Sub-Fund level the revenue share of each issuer attributable to business activities contributing to environmental and/or social objectives is considered provided the issuer is satisfying the Do No Significant Harm ("DNSH") and Good Governance principles, and an asset-weighted aggregation is performed as a second step. Moreover, for certain types of securities, which finance specific projects contributing to environmental or social objectives the overall investment is considered to contribute to environmental and/or social objectives, but also for these a DNSH as well as a Good Governance check for issuers is performed.

● **How do the sustainable investments that the financial product partially intends to make, not cause significant harm to any environmental or social sustainable investment objective?**

In order to ensure that Sustainable Investments do not significantly harm any other environmental and/or social objective, the Investment Manager is leveraging the PAI indicators, whereby significance thresholds have been defined to identify significantly harmful issuers. Issuers not meeting the significance threshold can be engaged for a limited time period to remediate the adverse impact. Otherwise, if the issuer does not meet the defined significance thresholds twice subsequently or in case of a failed engagement, it does not pass the DNSH assessment. Investments in securities of issuers which do not pass the DNSH assessment are not counted as sustainable investments.

● *How have the indicators for adverse impacts on sustainability factors been taken into account?*

All mandatory PAI indicators are considered either as part of the application of the exclusion criteria or through thresholds on a sectorial or absolute basis. Significance thresholds have been defined and they refer to qualitative or quantitative criteria.

Recognizing the lack of data coverage for some of the PAI indicators equivalent data points are used to assess PAI indicators when applying the DNSH assessment, when relevant, for the following indicators for corporates: share of non-renewable energy consumption and production, activities negatively affecting biodiversity-sensitive areas, emissions to water, lack of processes and compliance mechanisms to monitor compliance with UNGC principles and OECD Guidelines for Multinational Enterprises; for sovereigns: GHG Intensity and investee countries subject to social violations. In case of securities which finance specific projects contributing to environmental or social objectives equivalent data at project level might be used to ensure that Sustainable Investments do not significantly harm any other environmental and/or social objective. The Investment Manager will strive to increase data coverage for PAI indicators with low data coverage by engaging with issuers and data providers. The Investment Manager will regularly evaluate whether the availability of data has increased sufficiently to potentially include assessment of such data in the investment process.

● *How are the sustainable investments aligned with the OECD Guidelines for Multinational Enterprises and the UN Guiding Principles on Business and Human Rights? Details:*

The Investment Manager's sustainable minimum exclusion list screens out companies based on their involvement in controversial practices against international norms. The core normative framework consists of the Principles of the UN Global Compact, the OECD Guidelines for Multinational Enterprises

Principal adverse impacts are the most significant negative impacts of investment decisions on sustainability factors relating to environmental, social and employee matters, respect for human rights, anti-corruption and anti-bribery matters.

and the UN Guiding Principles for Business and Human Rights. Securities issued by companies having a severe violation of these frameworks will be restricted from the investment universe.

The EU Taxonomy sets out a “do not significant harm” principle by which Taxonomy-aligned investments should not significantly harm EU Taxonomy objectives and is accompanied by specific EU criteria.

The “do not significant harm” principle applies only to those investments underlying the financial product that take into account the EU criteria for environmentally sustainable economic activities. The investments underlying the remaining portion of this financial product do not take into account the EU criteria for environmentally sustainable economic activities.

Any other sustainable investments must also not significantly harm any environmental or social objectives.



Does this financial product consider principal adverse impacts on sustainability factors?

Yes

No

The Management Company has joined the Net Zero Asset Manager Initiative and considers PAI indicators through stewardship including engagement, both are relevant to mitigate potential adverse impact as a company.

Due to the commitment to the Net Zero Asset Manager Initiative, the Management Company aims to reduce greenhouse gas emissions in partnership with asset owner clients on decarbonisation goals, consistent with an ambition to reach net zero emission by 2050 or sooner across all assets under management. As part of this objective the Management Company will set an interim target for the proportion of assets to be managed in line with the attainment of net zero emissions by 2050 or sooner.

The Sub-Fund’s Investment Manager considers PAI indicators regarding greenhouse gas emission, biodiversity, water, waste as well as social and employee matters for corporate issuers, and, where relevant, the freedom house index is applied to investments in sovereigns. PAI indicators are considered within the Investment Manager’s investment process through the means of exclusions as described in the “binding elements” section of the Sub-Fund.

The data coverage for the data required for the PAI indicators is heterogenous. The data coverage related to biodiversity, water and waste is low and the related PAI indicators are considered through exclusion of securities issued by companies having a severe violation / breach of principles and guidelines such as the Principles of the United Nations Global Compact, the OECD Guidelines for Multinational Enterprises, and the United Nations Guiding Principles for Business and Human Rights on the grounds of problematic practices around human rights, labour rights, environment, and corruption issues. Therefore, the Investment Manager will strive to increase data coverage for PAI indicators with low data coverage. The Investment Manager will regularly evaluate whether the availability of data has increased sufficiently to potentially include assessment of such data in the investment process.

Additionally, PAI indicators are, among other sustainability factors, applied to derive the SRI Rating. The SRI Rating is used for the portfolio construction.

The following PAI indicators are considered:

Applicable to corporate issuers

- GHG Emissions
- Carbon footprint
- GHG Intensity of investee companies
- Exposure to companies active in the fossil fuel sector
- Activities negatively affecting biodiversity-sensitive areas
- Emissions to water
- Hazardous waste ratio
- Violation of UN Global compact principles
- Lack of processes and compliance mechanisms to monitor compliance with UN Global Compact principles
- Board gender diversity
- Exposure to controversial weapons

Applicable to sovereign and supranational issuers

- Investee countries subject to social violations

The information on the PAI indicators will be available in the end-year report of the Sub-Fund.



The investment strategy guides investment decisions based on factors such as investment objectives and risk tolerance.

What investment strategy does this financial product follow?

Allianz Dynamic Multi Asset Strategy SRI 15's investment objective is to invest in a broad range of asset classes, with a focus on global Equity, Bond and Money Markets in order to achieve over the medium-term a performance comparable to a balanced portfolio within a volatility range of 3% to 7% in accordance with the Sustainable and Responsible Investment Strategy (SRI Strategy).

The assessment of the volatility of the capital markets by the Investment Manager is an important factor in this process, with the aim of typically not falling below or exceeding a volatility of the Share price within a range of 3% to 7% on a medium to long-term average, similar to a portfolio consisting of 15% global equity markets and 85% Euro-denominated bonds of the Global bond markets.

As part of the SRI best-in-class approach, the Sub-Fund takes environmental, social, human rights, governance, and business behaviour factors into account as follows:

- The aforesaid sustainability factors are analysed through SRI Research by the Investment Manager in order to assess how sustainable development and long-term issues are taken into account in the strategy of an issuer. SRI Research means the overall process of identifying potential risks as well as potential opportunities of an investment in securities of an issuer related to the analysis of sustainability factors. SRI Research data combines external research data (which might have some limitations) with internal analyses.
- Based on a combination of the results of the external and/or internal analyses of the sustainability factors, an internal rating is derived monthly (SRI Rating) and is afterwards assigned to a corporate or sovereign issuer.

This internal SRI Rating is used to rank and select or weight securities for the portfolio construction.

The Sub-Fund's general investment approach (Sub-Fund's applicable General Asset Class Principles in combination with its individual investment restrictions) is described in the prospectus.

● What are the binding elements of the investment strategy used to select the investments to attain each of the environmental or social characteristics promoted by this financial product?

The binding elements are:

- Minimum rating coverage: At least 70% of the Sub-Fund's portfolio is required to have an SRI Rating (portfolio in this respect does not comprise non-rated derivatives and instruments that are non-rated by nature e.g., cash and deposits). While most holdings of the Sub-Fund will have a corresponding SRI Rating some investments cannot be rated according to the SRI Research methodology. Examples of instruments not attaining to the SRI Rating include, but are not limited to cash, deposits, Target Funds, and non-rated investments.
- 80% of the rated instruments are adhering to the minimum rating threshold of 1 (out of a rating scale from 0 – 4; 0 being the worst rating and 4 the best rating) for equities, and 100% for debt securities.
- Application of the following sustainable minimum exclusion criteria for direct investments:
 - securities issued by companies having a severe violation / breach of principles and guidelines such as the Principles of the United Nations Global Compact, the OECD Guidelines for Multinational Enterprises, and the United Nations Guiding Principles for Business and Human Rights on the grounds of problematic practices around human rights, labour rights, environment, and corruption issues,
 - securities issued by companies involved in controversial weapons (anti-personnel mines, cluster munitions, chemical weapons, biological weapons, depleted uranium, white phosphorus, and nuclear weapons),
 - securities issued by companies that derive more than 10% of their revenues from weapons, military equipment, and services,
 - securities issued by companies that derive more than 10% of their revenue from thermal coal extraction,
 - securities issued by utility companies that generate more than 20% of their revenues from coal,

- securities issued by companies involved in the production of tobacco, and securities issued by companies involved in the distribution of tobacco with more than 5% of their revenues.

Direct investments in sovereign issuers with an insufficient freedom house index score are excluded.

The sustainable minimum exclusion criteria are based on information from an external data provider and coded in pre- and post-trade compliance. The review is performed at least half yearly.

● **What is the committed minimum rate to reduce the scope of the investments considered prior to the application of that investment strategy?**

The Sub-Fund does not commit to reduce the scope of the investments by a certain minimum rate.

● **What is the policy to assess good governance practices of the investee companies?**

Good governance principles are considered by screening out companies based on their involvement in controversies around international norms corresponding to the four good governance practices: sound management structures, employee relations, remuneration of staff and tax compliance. Companies having a severe violation in either of those areas will not be investible. For certain cases, flagged issuers shall be on a watch list. These companies will appear on this watch list when the Investment Manager believes that engagement may lead to improvements or when the company is assessed to take remedial actions. Companies on the watch list remain investible unless the Investment Manager believes that the engagement or the remedial actions of the company does not lead to the desired remedy of the severe controversy.

In addition, the Sub-Fund’s Investment Manager is committed to actively encourage open dialogues with investee companies on corporate governance, proxy voting and broader sustainability issues in advance of shareholder meetings (regularly for direct investments in shares). The Sub-Fund’s Investment Manager’s approach to proxy voting and company engagement is set out in the Management Company’s Stewardship Statement.

Good governance practices include sound management structures, employee relations, remuneration of staff and tax compliance.



What is the asset allocation planned for this financial product?

Asset allocation describes the share of investments in specific assets.

Min. 70% of the Sub-Funds’ assets (excluding cash and non-rated derivatives) are used to meet the environmental or social characteristics promoted by this Sub-Fund. A low portion of the Sub-Fund might contain assets which do not promote environmental or social characteristics. Examples of such instruments are derivatives, cash and deposits, some Target Funds and investment with temporarily divergent or absent environmental, social, or good governance qualifications. Min. 1% of the Sub-Funds' assets will be invested in Sustainable Investments. The minimum percentage of investments that are aligned with the EU Taxonomy is 0.01%. The Sub-Fund’s Investment Manager does not commit to a minimum share of environmentally Sustainable Investments that are not aligned with the EU Taxonomy. The Sub-Fund’s Investment Manager does not commit to a minimum share of socially sustainable investments. While the Sub-Fund cannot commit to a minimum share of environmentally or socially sustainable investments, such investments may be freely allocated to within the Sub-Fund aggregated sustainable investment commitment disclosed (min. 1%).

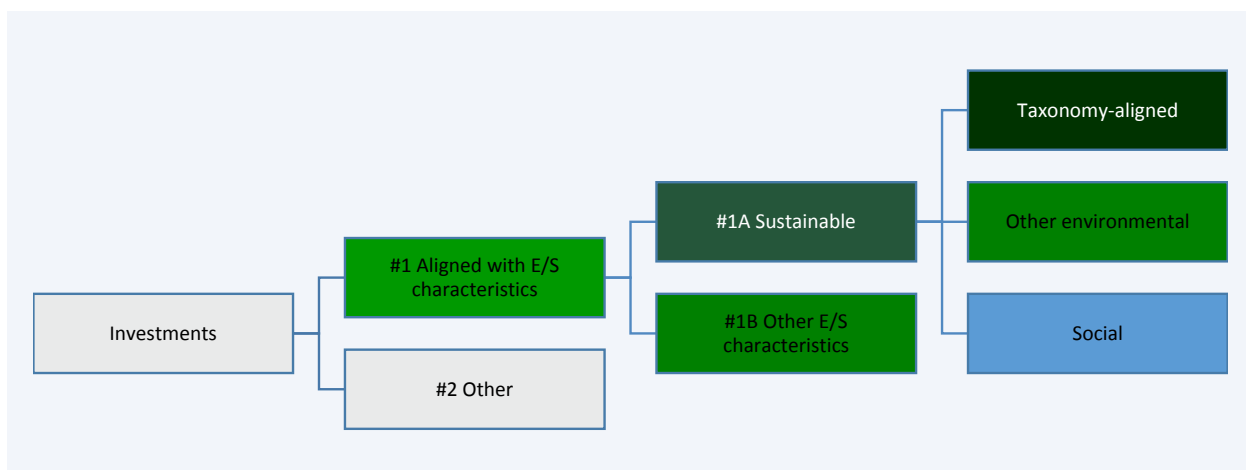

#1 Aligned with E/S characteristics includes the investments of the financial product used to attain the environmental or social characteristics promoted by the financial product.

#2 Other includes the remaining investments of the financial product which are neither aligned with the environmental or social characteristics, nor are qualified as sustainable investments.

The category **#1 Aligned with E/S characteristics** covers:

- The sub-category **#1A Sustainable** covers sustainable investments with environmental or social objectives.
- The sub-category **#1B Other E/S characteristics** covers investments aligned with the environmental or social characteristics that do not qualify as sustainable investments.

- **How does the use of derivatives attain the environmental or social characteristics promoted by the financial product?**

Not applicable



To what minimum extent are sustainable investments with an environmental objective aligned with the EU Taxonomy?

The Taxonomy-aligned investments include debt and/or equity in environmentally sustainable economic activities aligned with the EU-Taxonomy. The minimum percentage of investments that are aligned with the EU Taxonomy is 0.01%. Taxonomy-aligned data is provided by an external data provider. The Investment Manager has assessed the quality of such data. The data will not be subject to an assurance provided by auditors or a review by third parties. The data will not reflect any data in government bonds. As of today, there is no recognized methodology available to determine the proportion of Taxonomy-aligned activities when investing in government bonds.

Taxonomy-aligned activities in this disclosure are based on share of turnover. Pre-contractual figures use turnover as its financial metric as a default in line with the regulatory requirements and based on the fact that complete, verifiable or up-to date data for CAPEX and/or OPEX as financial metric is even less available.

Taxonomy-aligned data is only in rare cases data reported by companies in accordance with the EU Taxonomy. The data provider has derived Taxonomy-aligned data from other available equivalent public data.

- **Does the financial product invest in fossil gas and/or nuclear energy related activities that comply with the EU Taxonomy¹?**

Yes:

In fossil gas In nuclear energy

No

The Sub-Fund does not pursue any investments in fossil gas and/or nuclear energy related activities that comply with the EU Taxonomy. Nevertheless, as result of this investment strategy, investments may occur in corporates which are also active in these activities. Further information will be provided as part of the annual reporting, if relevant.

Taxonomy-aligned activities are expressed as a share of:

- **turnover** reflecting the share of revenue from green activities of investee companies
- **capital expenditure** (CapEx) showing the green investments made by investee companies, e.g. for a transition to a green economy.
- **operational expenditure** (OpEx) reflecting green operational activities of investee companies.

¹ Fossil gas and/or nuclear related activities will only comply with the EU Taxonomy where they contribute to limiting climate change ("climate change mitigation") and do not significantly harm any EU Taxonomy objective - see explanatory note in the left hand margin. The full criteria for fossil gas and nuclear energy economic activities that comply with the EU Taxonomy are laid down in Commission Delegated Regulation (EU) 2022/1214.

The two graphs below show in green the minimum percentage of investments that are aligned with the EU Taxonomy. As there is no appropriate methodology to determine the Taxonomy-alignment of sovereign bonds*, the first graph shows the Taxonomy-alignment in relation to all the investments of the financial product including sovereign bonds, while the second graph shows the Taxonomy-alignment only in relation to the investments of the financial product other than sovereign bonds.

1. Taxonomy-alignment of investments including sovereign bonds*

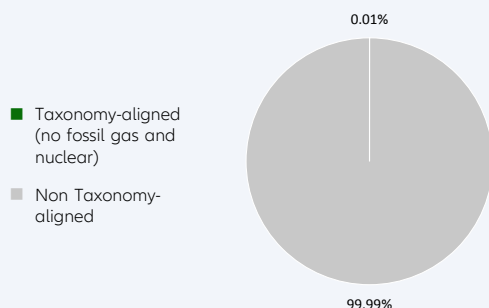

2. Taxonomy-alignment of investments excluding sovereign bonds*

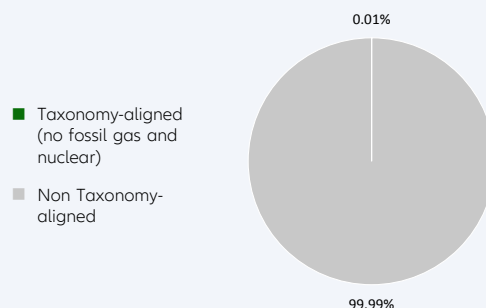

This graph represents X% of the total investments.

It is noted that this Sub-Fund does not provide for a binding minimum quota for investments in sovereign bonds. Therefore, this Sub-Fund may have (but must not have) an exposure to sovereign bonds. In the absence of a binding minimum quota for investments in sovereign bonds, this graph does not generate any additional added value compared to the left-hand graph.

* For the purpose of these graphs, 'sovereign bonds' consist of all sovereign exposures

Enabling activities directly enable other activities to make a substantial contribution to an environmental objective.

Transitional activities are activities for which low-carbon alternatives are not yet available and among others have greenhouse gas emission levels corresponding to the best performance.

● **What is the minimum share of investments in transitional and enabling activities?**

The Sub-Fund's Investment Manager does not commit to a split of minimum taxonomy alignment into transitional, enabling activities and own performance.



What is the minimum share of sustainable investments with an environmental objective that are not aligned with the EU Taxonomy?

Taxonomy-aligned investments are considered a sub-category of Sustainable Investments. If an investment is not Taxonomy-aligned since the activity is not yet covered under the EU Taxonomy or the positive contribution is not substantial enough to comply with the Taxonomy technical screening criteria, the investment can still be considered an environmentally Sustainable Investment provided it complies with all criteria. The Investment Manager does not commit to a minimum share of environmentally Sustainable Investments that are not aligned with the EU Taxonomy. The overall sustainable investment share may also include investments with an environmental objective in economic activities that do not qualify as environmentally sustainable under the EU Taxonomy, and while the Sub-Fund cannot commit to a minimum share of environmentally or socially sustainable investments, such investments may be freely allocated to within the Sub-Fund aggregated sustainable investment commitment disclosed (min. 1%).



are sustainable investments with an environmental objective that **do not take into account the criteria** for environmentally sustainable economic activities under the EU Taxonomy.



What is the minimum share of socially sustainable investments?

The Investment Manager defines Sustainable Investments based on internal research, which uses, among others, the UN Sustainable Development Goals (SDGs), as well as the objectives of the EU Taxonomy as reference frameworks. The Investment Manager does not commit to a minimum share of socially Sustainable Investments, as the SDGs contain environmental as well as social objectives. The overall sustainable investment share may also include investments with a social objective, and while the Sub-Fund cannot commit to a minimum share of environmentally or socially sustainable investments, such investments may be freely allocated to within the Sub-Fund aggregated sustainable investment commitment disclosed (min. 1%).



What investments are included under “#2 Other”, what is their purpose and are there any minimum environmental or social safeguards?

Under “#2 Other” investments into cash, Target Funds, or derivatives can be included. Derivatives might be used for efficient portfolio management (including risk hedging) and/or investment purposes, and Target Funds to benefit from a specific strategy. For those investments no environmental or social safeguards are applied.



Is a specific index designated as a reference benchmark to determine whether this financial product is aligned with the environmental and/or social characteristics that it promotes?

No reference benchmark has been designated for the purpose of attaining the environmental and/or social characteristics promoted by the Sub-Fund.

- How is the reference benchmark continuously aligned with each of the environmental or social characteristics promoted by the financial product?

Not applicable

- How is the alignment of the investment strategy with the methodology of the index ensured on a continuous basis?

Not applicable

- How does the designated index differ from a relevant broad market index?

Not applicable

- Where can the methodology used for the calculation of the designated index be found?

Not applicable

Reference benchmarks are indexes to measure whether the financial product attains the environmental or social characteristics that they promote.



Where can I find more product specific information online?

More product-specific information can be found on the website: <https://regulatory.allianzgi.com/SFDR>

Template pre-contractual disclosure for the financial products referred to in Article 8, paragraphs 1, 2 and 2a, of Regulation (EU) 2019/2088 and Article 6, first paragraph, of Regulation (EU) 2020/852

Product name:

Allianz Dynamic Multi Asset Strategy SRI 50

Legal entity identifier: 529900NLULWWNUAUMG29

Environmental and/or social characteristics

Sustainable investment means an investment in an economic activity that contributes to an environmental or social objective, provided that the investment does not significantly harm any environmental or social objective and that the investee companies follow good governance practices.

The **EU Taxonomy** is a classification system laid down in Regulation (EU) 2020/852, establishing a list of **environmentally sustainable economic activities**. That Regulation does not include a list of socially sustainable economic activities. Sustainable investments with an environmental objective might be aligned with the Taxonomy or not.

Does this financial product have a sustainable investment objective?	
<input checked="" type="radio"/> <input checked="" type="radio"/> Yes	<input checked="" type="radio"/> <input type="radio"/> No
<input type="checkbox"/> It will make a minimum of sustainable investments with an environmental objective: ___% <ul style="list-style-type: none"> <input type="checkbox"/> in economic activities that qualify as environmentally sustainable under the EU Taxonomy <input type="checkbox"/> in economic activities that do not qualify as environmentally sustainable under the EU Taxonomy 	<input checked="" type="checkbox"/> It promotes Environmental/Social (E/S) characteristics and while it does not have as its objective a sustainable investment, it will have a minimum proportion of 3.00% of sustainable investments <ul style="list-style-type: none"> <input checked="" type="checkbox"/> with an environmental objective in economic activities that qualify as environmentally sustainable under the EU Taxonomy <input checked="" type="checkbox"/> with an environmental objective in economic activities that do not qualify as environmentally sustainable under the EU Taxonomy <input checked="" type="checkbox"/> with a social objective
<input type="checkbox"/> It will make a minimum of sustainable investments with a social objective ___%	<input type="checkbox"/> It promotes E/S characteristics, but will not make any sustainable investments



What environmental and/or social characteristics are promoted by this financial product?

Allianz Dynamic Multi Asset Strategy SRI 50 (the "Sub-Fund") promotes environmental, social, human rights, governance, and business behaviour factors (this domain does not apply for sovereigns issued by a Sovereign Entity) through integration of a best-in-class approach into the Sub-Fund's investment process. This encompasses the evaluation of corporate or sovereign issuers based on an SRI Rating which is used to construct the portfolio.

In addition, sustainable minimum exclusion criteria apply.

No reference benchmark has been designated for the purpose of attaining the environmental and/or social characteristics promoted by the Sub-Fund.

● What sustainability indicators are used to measure the attainment of each of the environmental or social characteristics promoted by this financial product?

To measure the attainment of the environmental and/or social characteristics the following sustainability indicators are used and reported on, at the fiscal year end:

- The actual percentage of the Sub-Fund's Portfolio (Portfolio in this respect does not comprise non-rated derivatives and instruments that are non-rated by nature (e. g., cash and deposits)) assets invested in best-in-class issuers (issuers with a minimum SRI Rating of 1 out of a scale from 0-4; 0 being the worst rating and 4 the best rating).
- Confirmation that Principal Adverse Impacts (PAIs) of investment decisions on sustainability factors are considered through the application of exclusion criteria.

Sustainability indicators measure how the environmental or social characteristics promoted by the financial product are attained.

● **What are the objectives of the sustainable investments that the financial product partially intends to make and how does the sustainable investment contribute to such objectives?**

Sustainable investments contribute to environmental and/or social objectives, for which the Investment Manager uses as reference frameworks, among others, the UN Sustainable Development Goals (SDGs), as well as the objectives of the EU Taxonomy:

1. Climate Change Mitigation
2. Climate Change Adaptation
3. Sustainable Use and Protection of Water and Marine Resources
4. Transition to a Circular Economy
5. Pollution Prevention and Control
6. Protection and Restoration of Biodiversity and Ecosystems

The assessment of the positive contribution to the environmental or social objectives is based on a proprietary framework which combines quantitative elements with qualitative inputs from internal research. The methodology applies first a quantitative breakdown of a securities issuer into its business activities. The qualitative element of the framework is an assessment if business activities contribute positively to an environmental or a social objective.

To calculate the positive contribution on the Sub-Fund level the revenue share of each issuer attributable to business activities contributing to environmental and/or social objectives is considered provided the issuer is satisfying the Do No Significant Harm ("DNSH") and Good Governance principles, and an asset-weighted aggregation is performed as a second step. Moreover, for certain types of securities, which finance specific projects contributing to environmental or social objectives the overall investment is considered to contribute to environmental and/or social objectives, but also for these a DNSH as well as a Good Governance check for issuers is performed.

● **How do the sustainable investments that the financial product partially intends to make, not cause significant harm to any environmental or social sustainable investment objective?**

In order to ensure that Sustainable Investments do not significantly harm any other environmental and/or social objective, the Investment Manager is leveraging the PAI indicators, whereby significance thresholds have been defined to identify significantly harmful issuers. Issuers not meeting the significance threshold can be engaged for a limited time period to remediate the adverse impact. Otherwise, if the issuer does not meet the defined significance thresholds twice subsequently or in case of a failed engagement, it does not pass the DNSH assessment. Investments in securities of issuers which do not pass the DNSH assessment are not counted as sustainable investments.

● *How have the indicators for adverse impacts on sustainability factors been taken into account?*

All mandatory PAI indicators are considered either as part of the application of the exclusion criteria or through thresholds on a sectorial or absolute basis. Significance thresholds have been defined and they refer to qualitative or quantitative criteria.

Recognizing the lack of data coverage for some of the PAI indicators equivalent data points are used to assess PAI indicators when applying the DNSH assessment, when relevant, for the following indicators for corporates: share of non-renewable energy consumption and production, activities negatively affecting biodiversity-sensitive areas, emissions to water, lack of processes and compliance mechanisms to monitor compliance with UNGC principles and OECD Guidelines for Multinational Enterprises; for sovereigns: GHG Intensity and investee countries subject to social violations. In case of securities which finance specific projects contributing to environmental or social objectives equivalent data at project level might be used to ensure that Sustainable Investments do not significantly harm any other environmental and/or social objective. The Investment Manager will strive to increase data coverage for PAI indicators with low data coverage by engaging with issuers and data providers. The Investment Manager will regularly evaluate whether the availability of data has increased sufficiently to potentially include assessment of such data in the investment process.

● *How are the sustainable investments aligned with the OECD Guidelines for Multinational Enterprises and the UN Guiding Principles on Business and Human Rights? Details:*

The Investment Manager's sustainable minimum exclusion list screens out companies based on their involvement in controversial practices against international norms. The core normative framework consists of the Principles of the UN Global Compact, the OECD Guidelines for Multinational Enterprises

Principal adverse impacts are the most significant negative impacts of investment decisions on sustainability factors relating to environmental, social and employee matters, respect for human rights, anti-corruption and anti-bribery matters.

and the UN Guiding Principles for Business and Human Rights. Securities issued by companies having a severe violation of these frameworks will be restricted from the investment universe.

The EU Taxonomy sets out a “do not significant harm” principle by which Taxonomy-aligned investments should not significantly harm EU Taxonomy objectives and is accompanied by specific EU criteria.

The “do not significant harm” principle applies only to those investments underlying the financial product that take into account the EU criteria for environmentally sustainable economic activities. The investments underlying the remaining portion of this financial product do not take into account the EU criteria for environmentally sustainable economic activities.

Any other sustainable investments must also not significantly harm any environmental or social objectives.



Does this financial product consider principal adverse impacts on sustainability factors?

Yes

No

The Management Company has joined the Net Zero Asset Manager Initiative and considers PAI indicators through stewardship including engagement, both are relevant to mitigate potential adverse impact as a company.

Due to the commitment to the Net Zero Asset Manager Initiative, the Management Company aims to reduce greenhouse gas emissions in partnership with asset owner clients on decarbonisation goals, consistent with an ambition to reach net zero emission by 2050 or sooner across all assets under management. As part of this objective the Management Company will set an interim target for the proportion of assets to be managed in line with the attainment of net zero emissions by 2050 or sooner.

The Sub-Fund’s Investment Manager considers PAI indicators regarding greenhouse gas emission, biodiversity, water, waste as well as social and employee matters for corporate issuers, and, where relevant, the freedom house index is applied to investments in sovereigns. PAI indicators are considered within the Investment Manager’s investment process through the means of exclusions as described in the “binding elements” section of the Sub-Fund.

The data coverage for the data required for the PAI indicators is heterogenous. The data coverage related to biodiversity, water and waste is low and the related PAI indicators are considered through exclusion of securities issued by companies having a severe violation / breach of principles and guidelines such as the Principles of the United Nations Global Compact, the OECD Guidelines for Multinational Enterprises, and the United Nations Guiding Principles for Business and Human Rights on the grounds of problematic practices around human rights, labour rights, environment, and corruption issues. Therefore, the Investment Manager will strive to increase data coverage for PAI indicators with low data coverage. The Investment Manager will regularly evaluate whether the availability of data has increased sufficiently to potentially include assessment of such data in the investment process.

Additionally, PAI indicators are, among other sustainability factors, applied to derive the SRI Rating. The SRI Rating is used for the portfolio construction.

The following PAI indicators are considered:

Applicable to corporate issuers

- GHG Emissions
- Carbon footprint
- GHG Intensity of investee companies
- Exposure to companies active in the fossil fuel sector
- Activities negatively affecting biodiversity-sensitive areas
- Emissions to water
- Hazardous waste ratio
- Violation of UN Global compact principles
- Lack of processes and compliance mechanisms to monitor compliance with UN Global Compact principles
- Board gender diversity
- Exposure to controversial weapons

Applicable to sovereign and supranational issuers

- Investee countries subject to social violations

The information on the PAI indicators will be available in the end-year report of the Sub-Fund.



The investment strategy guides investment decisions based on factors such as investment objectives and risk tolerance.

What investment strategy does this financial product follow?

Allianz Dynamic Multi Asset Strategy SRI 50's investment objective is to invest in a broad range of asset classes, with a focus on global Equity, Bond and Money Markets in order to achieve over the medium-term a performance comparable to a balanced portfolio within a volatility range of 6% to 12% in accordance with the Sustainable and Responsible Investment Strategy (SRI Strategy).

The assessment of the volatility of the capital markets by the Investment Manager is an important factor in this process, with the aim of typically not falling below or exceeding a volatility of the Share price within a range of 6% to 12% on a medium to long-term average, similar to a portfolio consisting of 50% global equity markets and 50% Euro-denominated bonds of the Global bond markets.

As part of the SRI best-in-class approach, the Sub-Fund takes environmental, social, human rights, governance, and business behaviour factors into account as follows:

- The aforesaid sustainability factors are analysed through SRI Research by the Investment Manager in order to assess how sustainable development and long-term issues are taken into account in the strategy of an issuer. SRI Research means the overall process of identifying potential risks as well as potential opportunities of an investment in securities of an issuer related to the analysis of sustainability factors. SRI Research data combines external research data (which might have some limitations) with internal analyses.
- Based on a combination of the results of the external and/or internal analyses of the sustainability factors, an internal rating is derived monthly (SRI Rating) and is afterwards assigned to a corporate or sovereign issuer.

This internal SRI Rating is used to rank and select or weight securities for the portfolio construction.

The Sub-Fund's general investment approach (Sub-Fund's applicable General Asset Class Principles in combination with its individual investment restrictions) is described in the prospectus.

● What are the binding elements of the investment strategy used to select the investments to attain each of the environmental or social characteristics promoted by this financial product?

The binding elements are:

- Minimum rating coverage: At least 70% of the Sub-Fund's portfolio is required to have an SRI Rating (portfolio in this respect does not comprise non-rated derivatives and instruments that are non-rated by nature e.g., cash and deposits). While most holdings of the Sub-Fund will have a corresponding SRI Rating some investments cannot be rated according to the SRI Research methodology. Examples of instruments not attaining to the SRI Rating include, but are not limited to cash, deposits, Target Funds, and non-rated investments.
- 80% of the rated instruments are adhering to the minimum rating threshold of 1 (out of a rating scale from 0 – 4; 0 being the worst rating and 4 the best rating) for equities, and 100% for debt securities.
- Application of the following sustainable minimum exclusion criteria for direct investments:
 - securities issued by companies having a severe violation / breach of principles and guidelines such as the Principles of the United Nations Global Compact, the OECD Guidelines for Multinational Enterprises, and the United Nations Guiding Principles for Business and Human Rights on the grounds of problematic practices around human rights, labour rights, environment, and corruption issues,
 - securities issued by companies involved in controversial weapons (anti-personnel mines, cluster munitions, chemical weapons, biological weapons, depleted uranium, white phosphorus, and nuclear weapons),
 - securities issued by companies that derive more than 10% of their revenues from weapons, military equipment, and services,
 - securities issued by companies that derive more than 10% of their revenue from thermal coal extraction,
 - securities issued by utility companies that generate more than 20% of their revenues from coal,

- securities issued by companies involved in the production of tobacco, and securities issued by companies involved in the distribution of tobacco with more than 5% of their revenues.

Direct investments in sovereign issuers with an insufficient freedom house index score are excluded.

The sustainable minimum exclusion criteria are based on information from an external data provider and coded in pre- and post-trade compliance. The review is performed at least half yearly.

- **What is the committed minimum rate to reduce the scope of the investments considered prior to the application of that investment strategy?**

The Sub-Fund does not commit to reduce the scope of the investments by a certain minimum rate.

- **What is the policy to assess good governance practices of the investee companies?**

Good governance principles are considered by screening out companies based on their involvement in controversies around international norms corresponding to the four good governance practices: sound management structures, employee relations, remuneration of staff and tax compliance. Companies having a severe violation in either of those areas will not be investible. For certain cases, flagged issuers shall be on a watch list. These companies will appear on this watch list when the Investment Manager believes that engagement may lead to improvements or when the company is assessed to take remedial actions. Companies on the watch list remain investible unless the Investment Manager believes that the engagement or the remedial actions of the company does not lead to the desired remedy of the severe controversy.

In addition, the Sub-Fund’s Investment Manager is committed to actively encourage open dialogues with investee companies on corporate governance, proxy voting and broader sustainability issues in advance of shareholder meetings (regularly for direct investments in shares). The Sub-Fund’s Investment Manager’s approach to proxy voting and company engagement is set out in the Management Company’s Stewardship Statement.

Good governance practices include sound management structures, employee relations, remuneration of staff and tax compliance.



What is the asset allocation planned for this financial product?

Asset allocation describes the share of investments in specific assets.

Min. 70% of the Sub-Funds’ assets (excluding cash and non-rated derivatives) are used to meet the environmental or social characteristics promoted by this Sub-Fund. A low portion of the Sub-Fund might contain assets which do not promote environmental or social characteristics. Examples of such instruments are derivatives, cash and deposits, some Target Funds and investment with temporarily divergent or absent environmental, social, or good governance qualifications. Min. 3% of the Sub-Funds' assets will be invested in Sustainable Investments. The minimum percentage of investments that are aligned with the EU Taxonomy is 0.01%. The Sub-Fund’s Investment Manager does not commit to a minimum share of environmentally Sustainable Investments that are not aligned with the EU Taxonomy. The Sub-Fund’s Investment Manager does not commit to a minimum share of socially sustainable investments. While the Sub-Fund cannot commit to a minimum share of environmentally or socially sustainable investments, such investments may be freely allocated to within the Sub-Fund aggregated sustainable investment commitment disclosed (min. 3%).

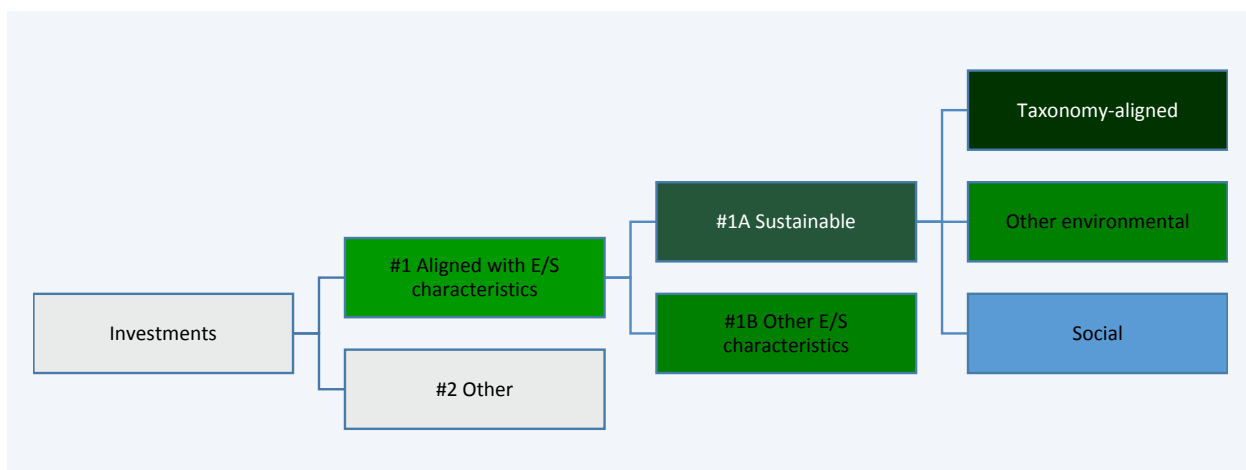

#1 Aligned with E/S characteristics includes the investments of the financial product used to attain the environmental or social characteristics promoted by the financial product.

#2 Other includes the remaining investments of the financial product which are neither aligned with the environmental or social characteristics, nor are qualified as sustainable investments.

The category **#1 Aligned with E/S characteristics** covers:

- The sub-category **#1A Sustainable** covers sustainable investments with environmental or social objectives.
- The sub-category **#1B Other E/S characteristics** covers investments aligned with the environmental or social characteristics that do not qualify as sustainable investments.

- **How does the use of derivatives attain the environmental or social characteristics promoted by the financial product?**

Not applicable



To what minimum extent are sustainable investments with an environmental objective aligned with the EU Taxonomy?

The Taxonomy-aligned investments include debt and/or equity in environmentally sustainable economic activities aligned with the EU-Taxonomy. The minimum percentage of investments that are aligned with the EU Taxonomy is 0.01%. Taxonomy-aligned data is provided by an external data provider. The Investment Manager has assessed the quality of such data. The data will not be subject to an assurance provided by auditors or a review by third parties. The data will not reflect any data in government bonds. As of today, there is no recognized methodology available to determine the proportion of Taxonomy-aligned activities when investing in government bonds.

Taxonomy-aligned activities in this disclosure are based on share of turnover. Pre-contractual figures use turnover as its financial metric as a default in line with the regulatory requirements and based on the fact that complete, verifiable or up-to date data for CAPEX and/or OPEX as financial metric is even less available.

Taxonomy-aligned data is only in rare cases data reported by companies in accordance with the EU Taxonomy. The data provider has derived Taxonomy-aligned data from other available equivalent public data.

- **Does the financial product invest in fossil gas and/or nuclear energy related activities that comply with the EU Taxonomy¹?**

Yes:

In fossil gas In nuclear energy

No

The Sub-Fund does not pursue any investments in fossil gas and/or nuclear energy related activities that comply with the EU Taxonomy. Nevertheless, as result of this investment strategy, investments may occur in corporates which are also active in these activities. Further information will be provided as part of the annual reporting, if relevant.

Taxonomy-aligned activities are expressed as a share of:

- **turnover** reflecting the share of revenue from green activities of investee companies
- **capital expenditure** (CapEx) showing the green investments made by investee companies, e.g. for a transition to a green economy.
- **operational expenditure** (OpEx) reflecting green operational activities of investee companies.

¹ Fossil gas and/or nuclear related activities will only comply with the EU Taxonomy where they contribute to limiting climate change ("climate change mitigation") and do not significantly harm any EU Taxonomy objective - see explanatory note in the left hand margin. The full criteria for fossil gas and nuclear energy economic activities that comply with the EU Taxonomy are laid down in Commission Delegated Regulation (EU) 2022/1214.

The two graphs below show in green the minimum percentage of investments that are aligned with the EU Taxonomy. As there is no appropriate methodology to determine the Taxonomy-alignment of sovereign bonds*, the first graph shows the Taxonomy-alignment in relation to all the investments of the financial product including sovereign bonds, while the second graph shows the Taxonomy-alignment only in relation to the investments of the financial product other than sovereign bonds.

1. Taxonomy-alignment of investments including sovereign bonds*

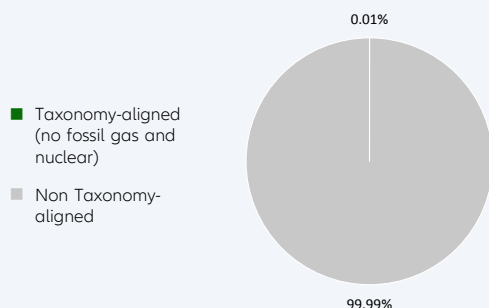

2. Taxonomy-alignment of investments excluding sovereign bonds*

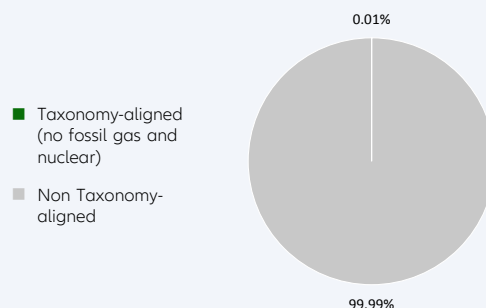

This graph represents X% of the total investments.

It is noted that this Sub-Fund does not provide for a binding minimum quota for investments in sovereign bonds. Therefore, this Sub-Fund may have (but must not have) an exposure to sovereign bonds. In the absence of a binding minimum quota for investments in sovereign bonds, this graph does not generate any additional added value compared to the left-hand graph.

* For the purpose of these graphs, 'sovereign bonds' consist of all sovereign exposures

Enabling activities directly enable other activities to make a substantial contribution to an environmental objective.

Transitional activities are activities for which low-carbon alternatives are not yet available and among others have greenhouse gas emission levels corresponding to the best performance.

● **What is the minimum share of investments in transitional and enabling activities?**

The Sub-Fund's Investment Manager does not commit to a split of minimum taxonomy alignment into transitional, enabling activities and own performance.



What is the minimum share of sustainable investments with an environmental objective that are not aligned with the EU Taxonomy?

Taxonomy-aligned investments are considered a sub-category of Sustainable Investments. If an investment is not Taxonomy-aligned since the activity is not yet covered under the EU Taxonomy or the positive contribution is not substantial enough to comply with the Taxonomy technical screening criteria, the investment can still be considered an environmentally Sustainable Investment provided it complies with all criteria. The Investment Manager does not commit to a minimum share of environmentally Sustainable Investments that are not aligned with the EU Taxonomy. The overall sustainable investment share may also include investments with an environmental objective in economic activities that do not qualify as environmentally sustainable under the EU Taxonomy, and while the Sub-Fund cannot commit to a minimum share of environmentally or socially sustainable investments, such investments may be freely allocated to within the Sub-Fund aggregated sustainable investment commitment disclosed (min. 3%).



are sustainable investments with an environmental objective that **do not take into account the criteria** for environmentally sustainable economic activities under the EU Taxonomy.



What is the minimum share of socially sustainable investments?

The Investment Manager defines Sustainable Investments based on internal research, which uses, among others, the UN Sustainable Development Goals (SDGs), as well as the objectives of the EU Taxonomy as reference frameworks. The Investment Manager does not commit to a minimum share of socially Sustainable Investments, as the SDGs contain environmental as well as social objectives. The overall sustainable investment share may also include investments with a social objective, and while the Sub-Fund cannot commit to a minimum share of environmentally or socially sustainable investments, such investments may be freely allocated to within the Sub-Fund aggregated sustainable investment commitment disclosed (min. 3%).



What investments are included under “#2 Other”, what is their purpose and are there any minimum environmental or social safeguards?

Under “#2 Other” investments into cash, Target Funds, or derivatives can be included. Derivatives might be used for efficient portfolio management (including risk hedging) and/or investment purposes, and Target Funds to benefit from a specific strategy. For those investments no environmental or social safeguards are applied.



Is a specific index designated as a reference benchmark to determine whether this financial product is aligned with the environmental and/or social characteristics that it promotes?

No reference benchmark has been designated for the purpose of attaining the environmental and/or social characteristics promoted by the Sub-Fund.

- How is the reference benchmark continuously aligned with each of the environmental or social characteristics promoted by the financial product?

Not applicable

- How is the alignment of the investment strategy with the methodology of the index ensured on a continuous basis?

Not applicable

- How does the designated index differ from a relevant broad market index?

Not applicable

- Where can the methodology used for the calculation of the designated index be found?

Not applicable



Where can I find more product specific information online?

More product-specific information can be found on the website: <https://regulatory.allianzgi.com/SFDR>

Reference benchmarks are indexes to measure whether the financial product attains the environmental or social characteristics that they promote.

Template pre-contractual disclosure for the financial products referred to in Article 8, paragraphs 1, 2 and 2a, of Regulation (EU) 2019/2088 and Article 6, first paragraph, of Regulation (EU) 2020/852

Product name:

Allianz Dynamic Multi Asset Strategy SRI 75

Legal entity identifier: 549300MVGM26JNLKWO33

Environmental and/or social characteristics

Sustainable investment means an investment in an economic activity that contributes to an environmental or social objective, provided that the investment does not significantly harm any environmental or social objective and that the investee companies follow good governance practices.

The **EU Taxonomy** is a classification system laid down in Regulation (EU) 2020/852, establishing a list of **environmentally sustainable economic activities**. That Regulation does not include a list of socially sustainable economic activities. Sustainable investments with an environmental objective might be aligned with the Taxonomy or not.

Does this financial product have a sustainable investment objective?	
Yes	No
<input type="checkbox"/> It will make a minimum of sustainable investments with an environmental objective: ___% <ul style="list-style-type: none"> <input type="checkbox"/> in economic activities that qualify as environmentally sustainable under the EU Taxonomy <input type="checkbox"/> in economic activities that do not qualify as environmentally sustainable under the EU Taxonomy 	<input checked="" type="checkbox"/> It promotes Environmental/Social (E/S) characteristics and while it does not have as its objective a sustainable investment, it will have a minimum proportion of 5.00% of sustainable investments <ul style="list-style-type: none"> <input checked="" type="checkbox"/> with an environmental objective in economic activities that qualify as environmentally sustainable under the EU Taxonomy <input checked="" type="checkbox"/> with an environmental objective in economic activities that do not qualify as environmentally sustainable under the EU Taxonomy <input checked="" type="checkbox"/> with a social objective
<input type="checkbox"/> It will make a minimum of sustainable investments with a social objective ___%	<input type="checkbox"/> It promotes E/S characteristics, but will not make any sustainable investments



What environmental and/or social characteristics are promoted by this financial product?

Allianz Dynamic Multi Asset Strategy SRI 75 (the "Sub-Fund") promotes environmental, social, human rights, governance, and business behaviour factors (this domain does not apply for sovereigns issued by a Sovereign Entity) through integration of a best-in-class approach into the Sub-Fund's investment process. This encompasses the evaluation of corporate or sovereign issuers based on an SRI Rating which is used to construct the portfolio.

In addition, sustainable minimum exclusion criteria apply.

No reference benchmark has been designated for the purpose of attaining the environmental and/or social characteristics promoted by the Sub-Fund.

What sustainability indicators are used to measure the attainment of each of the environmental or social characteristics promoted by this financial product?

To measure the attainment of the environmental and/or social characteristics the following sustainability indicators are used and reported on, at the fiscal year end:

- The actual percentage of the Sub-Fund's Portfolio (Portfolio in this respect does not comprise non-rated derivatives and instruments that are non-rated by nature (e. g., cash and deposits)) assets invested in best-in-class issuers (issuers with a minimum SRI Rating of 1 out of a scale from 0-4; 0 being the worst rating and 4 the best rating).
- Confirmation that Principal Adverse Impacts (PAIs) of investment decisions on sustainability factors are considered through the application of exclusion criteria.

● **What are the objectives of the sustainable investments that the financial product partially intends to make and how does the sustainable investment contribute to such objectives?**

Sustainable investments contribute to environmental and/or social objectives, for which the Investment Manager uses as reference frameworks, among others, the UN Sustainable Development Goals (SDGs), as well as the objectives of the EU Taxonomy:

1. Climate Change Mitigation
2. Climate Change Adaptation
3. Sustainable Use and Protection of Water and Marine Resources
4. Transition to a Circular Economy
5. Pollution Prevention and Control
6. Protection and Restoration of Biodiversity and Ecosystems

The assessment of the positive contribution to the environmental or social objectives is based on a proprietary framework which combines quantitative elements with qualitative inputs from internal research. The methodology applies first a quantitative breakdown of a securities issuer into its business activities. The qualitative element of the framework is an assessment if business activities contribute positively to an environmental or a social objective.

To calculate the positive contribution on the Sub-Fund level the revenue share of each issuer attributable to business activities contributing to environmental and/or social objectives is considered provided the issuer is satisfying the Do No Significant Harm (“DNSH”) and Good Governance principles, and an asset-weighted aggregation is performed as a second step. Moreover, for certain types of securities, which finance specific projects contributing to environmental or social objectives the overall investment is considered to contribute to environmental and/or social objectives, but also for these a DNSH as well as a Good Governance check for issuers is performed.

● **How do the sustainable investments that the financial product partially intends to make, not cause significant harm to any environmental or social sustainable investment objective?**

In order to ensure that Sustainable Investments do not significantly harm any other environmental and/or social objective, the Investment Manager is leveraging the PAI indicators, whereby significance thresholds have been defined to identify significantly harmful issuers. Issuers not meeting the significance threshold can be engaged for a limited time period to remediate the adverse impact. Otherwise, if the issuer does not meet the defined significance thresholds twice subsequently or in case of a failed engagement, it does not pass the DNSH assessment. Investments in securities of issuers which do not pass the DNSH assessment are not counted as sustainable investments.

● *How have the indicators for adverse impacts on sustainability factors been taken into account?*

All mandatory PAI indicators are considered either as part of the application of the exclusion criteria or through thresholds on a sectorial or absolute basis. Significance thresholds have been defined and they refer to qualitative or quantitative criteria.

Recognizing the lack of data coverage for some of the PAI indicators equivalent data points are used to assess PAI indicators when applying the DNSH assessment, when relevant, for the following indicators for corporates: share of non-renewable energy consumption and production, activities negatively affecting biodiversity-sensitive areas, emissions to water, lack of processes and compliance mechanisms to monitor compliance with UNGC principles and OECD Guidelines for Multinational Enterprises; for sovereigns: GHG Intensity and investee countries subject to social violations. In case of securities which finance specific projects contributing to environmental or social objectives equivalent data at project level might be used to ensure that Sustainable Investments do not significantly harm any other environmental and/or social objective. The Investment Manager will strive to increase data coverage for PAI indicators with low data coverage by engaging with issuers and data providers. The Investment Manager will regularly evaluate whether the availability of data has increased sufficiently to potentially include assessment of such data in the investment process.

● *How are the sustainable investments aligned with the OECD Guidelines for Multinational Enterprises and the UN Guiding Principles on Business and Human Rights? Details:*

The Investment Manager’s sustainable minimum exclusion list screens out companies based on their involvement in controversial practices against international norms. The core normative framework consists of the Principles of the UN Global Compact, the OECD Guidelines for Multinational Enterprises

Principal adverse impacts are the most significant negative impacts of investment decisions on sustainability factors relating to environmental, social and employee matters, respect for human rights, anti-corruption and anti-bribery matters.

and the UN Guiding Principles for Business and Human Rights. Securities issued by companies having a severe violation of these frameworks will be restricted from the investment universe.

The EU Taxonomy sets out a “do not significant harm” principle by which Taxonomy-aligned investments should not significantly harm EU Taxonomy objectives and is accompanied by specific EU criteria.

The “do not significant harm” principle applies only to those investments underlying the financial product that take into account the EU criteria for environmentally sustainable economic activities. The investments underlying the remaining portion of this financial product do not take into account the EU criteria for environmentally sustainable economic activities.

Any other sustainable investments must also not significantly harm any environmental or social objectives.



Does this financial product consider principal adverse impacts on sustainability factors?

Yes

No

The Management Company has joined the Net Zero Asset Manager Initiative and considers PAI indicators through stewardship including engagement, both are relevant to mitigate potential adverse impact as a company.

Due to the commitment to the Net Zero Asset Manager Initiative, the Management Company aims to reduce greenhouse gas emissions in partnership with asset owner clients on decarbonisation goals, consistent with an ambition to reach net zero emission by 2050 or sooner across all assets under management. As part of this objective the Management Company will set an interim target for the proportion of assets to be managed in line with the attainment of net zero emissions by 2050 or sooner.

The Sub-Fund’s Investment Manager considers PAI indicators regarding greenhouse gas emission, biodiversity, water, waste as well as social and employee matters for corporate issuers, and, where relevant, the freedom house index is applied to investments in sovereigns. PAI indicators are considered within the Investment Manager’s investment process through the means of exclusions as described in the “binding elements” section of the Sub-Fund.

The data coverage for the data required for the PAI indicators is heterogenous. The data coverage related to biodiversity, water and waste is low and the related PAI indicators are considered through exclusion of securities issued by companies having a severe violation / breach of principles and guidelines such as the Principles of the United Nations Global Compact, the OECD Guidelines for Multinational Enterprises, and the United Nations Guiding Principles for Business and Human Rights on the grounds of problematic practices around human rights, labour rights, environment, and corruption issues. Therefore, the Investment Manager will strive to increase data coverage for PAI indicators with low data coverage. The Investment Manager will regularly evaluate whether the availability of data has increased sufficiently to potentially include assessment of such data in the investment process.

Additionally, PAI indicators are, among other sustainability factors, applied to derive the SRI Rating. The SRI Rating is used for the portfolio construction.

The following PAI indicators are considered:

Applicable to corporate issuers

- GHG Emissions
- Carbon footprint
- GHG Intensity of investee companies
- Exposure to companies active in the fossil fuel sector
- Activities negatively affecting biodiversity-sensitive areas
- Emissions to water
- Hazardous waste ratio
- Violation of UN Global compact principles
- Lack of processes and compliance mechanisms to monitor compliance with UN Global Compact principles
- Board gender diversity
- Exposure to controversial weapons

Applicable to sovereign and supranational issuers

- Investee countries subject to social violations

The information on the PAI indicators will be available in the end-year report of the Sub-Fund.



The investment strategy guides investment decisions based on factors such as investment objectives and risk tolerance.

What investment strategy does this financial product follow?

Allianz Dynamic Multi Asset Strategy SRI 75's investment objective is to invest in a broad range of asset classes, with a focus on global Equity, Bond and Money Markets in order to achieve over the medium-term a performance comparable to a balanced portfolio within a volatility range of 10% to 16% in accordance with the Sustainable and Responsible Investment Strategy (SRI Strategy).

The assessment of the volatility of the capital markets by the Investment Manager is an important factor in this process, with the aim of typically not falling below or exceeding a volatility of the Share price within a range of 10% to 16% on a medium to long-term average, similar to a portfolio consisting of 75% global equity markets and 25% Euro-denominated bonds of the Global bond markets.

As part of the SRI best-in-class approach, the Sub-Fund takes environmental, social, human rights, governance, and business behaviour factors into account as follows:

- The aforesaid sustainability factors are analysed through SRI Research by the Investment Manager in order to assess how sustainable development and long-term issues are taken into account in the strategy of an issuer. SRI Research means the overall process of identifying potential risks as well as potential opportunities of an investment in securities of an issuer related to the analysis of sustainability factors. SRI Research data combines external research data (which might have some limitations) with internal analyses.
- Based on a combination of the results of the external and/or internal analyses of the sustainability factors, an internal rating is derived monthly (SRI Rating) and is afterwards assigned to a corporate or sovereign issuer.

This internal SRI Rating is used to rank and select or weight securities for the portfolio construction.

The Sub-Fund's general investment approach (Sub-Fund's applicable General Asset Class Principles in combination with its individual investment restrictions) is described in the prospectus.

● What are the binding elements of the investment strategy used to select the investments to attain each of the environmental or social characteristics promoted by this financial product?

The binding elements are:

- Minimum rating coverage: At least 70% of the Sub-Fund's portfolio is required to have an SRI Rating (portfolio in this respect does not comprise non-rated derivatives and instruments that are non-rated by nature e.g., cash and deposits). While most holdings of the Sub-Fund will have a corresponding SRI Rating some investments cannot be rated according to the SRI Research methodology. Examples of instruments not attaining to the SRI Rating include, but are not limited to cash, deposits, Target Funds, and non-rated investments.
- 80% of the rated instruments are adhering to the minimum rating threshold of 1 (out of a rating scale from 0 – 4; 0 being the worst rating and 4 the best rating) for equities, and 100% for debt securities.
- Application of the following sustainable minimum exclusion criteria for direct investments:
 - securities issued by companies having a severe violation / breach of principles and guidelines such as the Principles of the United Nations Global Compact, the OECD Guidelines for Multinational Enterprises, and the United Nations Guiding Principles for Business and Human Rights on the grounds of problematic practices around human rights, labour rights, environment, and corruption issues,
 - securities issued by companies involved in controversial weapons (anti-personnel mines, cluster munitions, chemical weapons, biological weapons, depleted uranium, white phosphorus, and nuclear weapons),
 - securities issued by companies that derive more than 10% of their revenues from weapons, military equipment, and services,
 - securities issued by companies that derive more than 10% of their revenue from thermal coal extraction,
 - securities issued by utility companies that generate more than 20% of their revenues from coal,

- securities issued by companies involved in the production of tobacco, and securities issued by companies involved in the distribution of tobacco with more than 5% of their revenues.

Direct investments in sovereign issuers with an insufficient freedom house index score are excluded.

The sustainable minimum exclusion criteria are based on information from an external data provider and coded in pre- and post-trade compliance. The review is performed at least half yearly.

● **What is the committed minimum rate to reduce the scope of the investments considered prior to the application of that investment strategy?**

The Sub-Fund does not commit to reduce the scope of the investments by a certain minimum rate.

● **What is the policy to assess good governance practices of the investee companies?**

Good governance principles are considered by screening out companies based on their involvement in controversies around international norms corresponding to the four good governance practices: sound management structures, employee relations, remuneration of staff and tax compliance. Companies having a severe violation in either of those areas will not be investible. For certain cases, flagged issuers shall be on a watch list. These companies will appear on this watch list when the Investment Manager believes that engagement may lead to improvements or when the company is assessed to take remedial actions. Companies on the watch list remain investible unless the Investment Manager believes that the engagement or the remedial actions of the company does not lead to the desired remedy of the severe controversy.

In addition, the Sub-Fund’s Investment Manager is committed to actively encourage open dialogues with investee companies on corporate governance, proxy voting and broader sustainability issues in advance of shareholder meetings (regularly for direct investments in shares). The Sub-Fund’s Investment Manager’s approach to proxy voting and company engagement is set out in the Management Company’s Stewardship Statement.

Good governance practices include sound management structures, employee relations, remuneration of staff and tax compliance.



What is the asset allocation planned for this financial product?

Asset allocation describes the share of investments in specific assets.

Min. 70% of the Sub-Funds’ assets (excluding cash and non-rated derivatives) are used to meet the environmental or social characteristics promoted by this Sub-Fund. A low portion of the Sub-Fund might contain assets which do not promote environmental or social characteristics. Examples of such instruments are derivatives, cash and deposits, some Target Funds and investment with temporarily divergent or absent environmental, social, or good governance qualifications. Min. 5% of the Sub-Funds' assets will be invested in Sustainable Investments. The minimum percentage of investments that are aligned with the EU Taxonomy is 0.01%. The Sub-Fund’s Investment Manager does not commit to a minimum share of environmentally Sustainable Investments that are not aligned with the EU Taxonomy. The Sub-Fund’s Investment Manager does not commit to a minimum share of socially sustainable investments. While the Sub-Fund cannot commit to a minimum share of environmentally or socially sustainable investments, such investments may be freely allocated to within the Sub-Fund aggregated sustainable investment commitment disclosed (min. 5%).

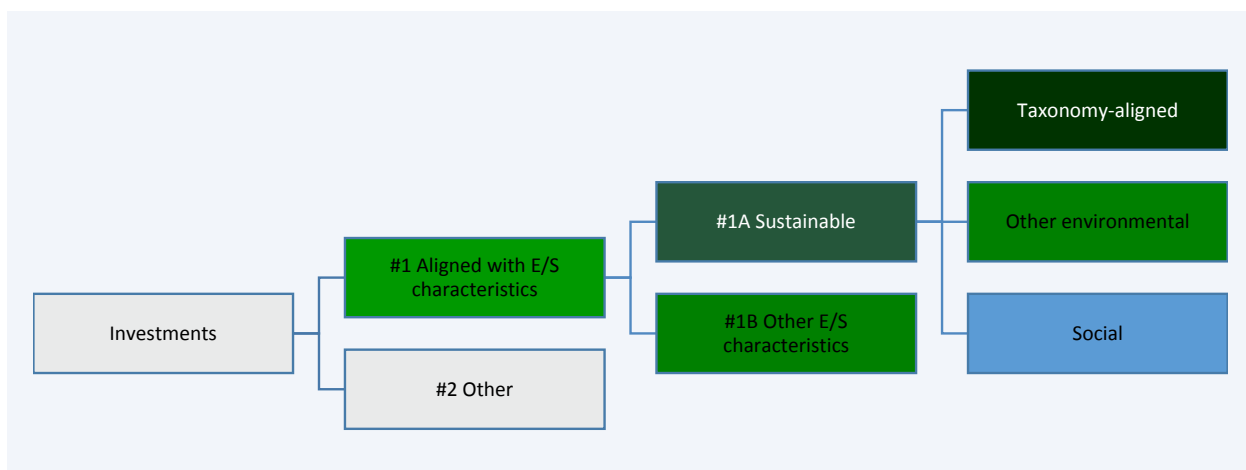

#1 Aligned with E/S characteristics includes the investments of the financial product used to attain the environmental or social characteristics promoted by the financial product.

#2 Other includes the remaining investments of the financial product which are neither aligned with the environmental or social characteristics, nor are qualified as sustainable investments.

The category **#1 Aligned with E/S characteristics** covers:

- The sub-category **#1A Sustainable** covers sustainable investments with environmental or social objectives.
- The sub-category **#1B Other E/S characteristics** covers investments aligned with the environmental or social characteristics that do not qualify as sustainable investments.

- **How does the use of derivatives attain the environmental or social characteristics promoted by the financial product?**

Not applicable



To what minimum extent are sustainable investments with an environmental objective aligned with the EU Taxonomy?

The Taxonomy-aligned investments include debt and/or equity in environmentally sustainable economic activities aligned with the EU-Taxonomy. The minimum percentage of investments that are aligned with the EU Taxonomy is 0.01%. Taxonomy-aligned data is provided by an external data provider. The Investment Manager has assessed the quality of such data. The data will not be subject to an assurance provided by auditors or a review by third parties. The data will not reflect any data in government bonds. As of today, there is no recognized methodology available to determine the proportion of Taxonomy-aligned activities when investing in government bonds.

Taxonomy-aligned activities in this disclosure are based on share of turnover. Pre-contractual figures use turnover as its financial metric as a default in line with the regulatory requirements and based on the fact that complete, verifiable or up-to date data for CAPEX and/or OPEX as financial metric is even less available.

Taxonomy-aligned data is only in rare cases data reported by companies in accordance with the EU Taxonomy. The data provider has derived Taxonomy-aligned data from other available equivalent public data.

- **Does the financial product invest in fossil gas and/or nuclear energy related activities that comply with the EU Taxonomy¹?**

Yes:

In fossil gas In nuclear energy

No

The Sub-Fund does not pursue any investments in fossil gas and/or nuclear energy related activities that comply with the EU Taxonomy. Nevertheless, as result of this investment strategy, investments may occur in corporates which are also active in these activities. Further information will be provided as part of the annual reporting, if relevant.

Taxonomy-aligned activities are expressed as a share of:

- **turnover** reflecting the share of revenue from green activities of investee companies
- **capital expenditure** (CapEx) showing the green investments made by investee companies, e.g. for a transition to a green economy.
- **operational expenditure** (OpEx) reflecting green operational activities of investee companies.

¹ Fossil gas and/or nuclear related activities will only comply with the EU Taxonomy where they contribute to limiting climate change ("climate change mitigation") and do not significantly harm any EU Taxonomy objective - see explanatory note in the left hand margin. The full criteria for fossil gas and nuclear energy economic activities that comply with the EU Taxonomy are laid down in Commission Delegated Regulation (EU) 2022/1214.

The two graphs below show in green the minimum percentage of investments that are aligned with the EU Taxonomy. As there is no appropriate methodology to determine the Taxonomy-alignment of sovereign bonds*, the first graph shows the Taxonomy-alignment in relation to all the investments of the financial product including sovereign bonds, while the second graph shows the Taxonomy-alignment only in relation to the investments of the financial product other than sovereign bonds.

1. Taxonomy-alignment of investments including sovereign bonds*

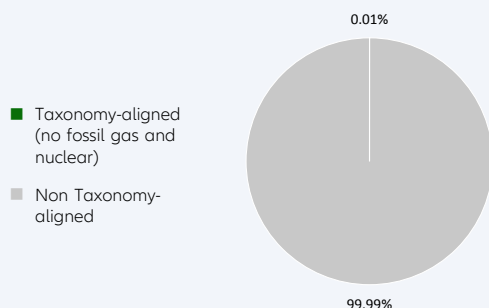

2. Taxonomy-alignment of investments excluding sovereign bonds*

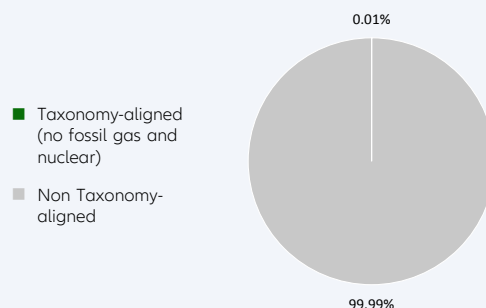

This graph represents X% of the total investments.

It is noted that this Sub-Fund does not provide for a binding minimum quota for investments in sovereign bonds. Therefore, this Sub-Fund may have (but must not have) an exposure to sovereign bonds. In the absence of a binding minimum quota for investments in sovereign bonds, this graph does not generate any additional added value compared to the left-hand graph.

* For the purpose of these graphs, 'sovereign bonds' consist of all sovereign exposures

Enabling activities directly enable other activities to make a substantial contribution to an environmental objective.

Transitional activities are activities for which low-carbon alternatives are not yet available and among others have greenhouse gas emission levels corresponding to the best performance.

● **What is the minimum share of investments in transitional and enabling activities?**

The Sub-Fund's Investment Manager does not commit to a split of minimum taxonomy alignment into transitional, enabling activities and own performance.



What is the minimum share of sustainable investments with an environmental objective that are not aligned with the EU Taxonomy?

Taxonomy-aligned investments are considered a sub-category of Sustainable Investments. If an investment is not Taxonomy-aligned since the activity is not yet covered under the EU Taxonomy or the positive contribution is not substantial enough to comply with the Taxonomy technical screening criteria, the investment can still be considered an environmentally Sustainable Investment provided it complies with all criteria. The Investment Manager does not commit to a minimum share of environmentally Sustainable Investments that are not aligned with the EU Taxonomy. The overall sustainable investment share may also include investments with an environmental objective in economic activities that do not qualify as environmentally sustainable under the EU Taxonomy, and while the Sub-Fund cannot commit to a minimum share of environmentally or socially sustainable investments, such investments may be freely allocated to within the Sub-Fund aggregated sustainable investment commitment disclosed (min. 5%).



are sustainable investments with an environmental objective that **do not take into account the criteria** for environmentally sustainable economic activities under the EU Taxonomy.



What is the minimum share of socially sustainable investments?

The Investment Manager defines Sustainable Investments based on internal research, which uses, among others, the UN Sustainable Development Goals (SDGs), as well as the objectives of the EU Taxonomy as reference frameworks. The Investment Manager does not commit to a minimum share of socially Sustainable Investments, as the SDGs contain environmental as well as social objectives. The overall sustainable investment share may also include investments with a social objective, and while the Sub-Fund cannot commit to a minimum share of environmentally or socially sustainable investments, such investments may be freely allocated to within the Sub-Fund aggregated sustainable investment commitment disclosed (min. 5%).



What investments are included under “#2 Other”, what is their purpose and are there any minimum environmental or social safeguards?

Under “#2 Other” investments into cash, Target Funds, or derivatives can be included. Derivatives might be used for efficient portfolio management (including risk hedging) and/or investment purposes, and Target Funds to benefit from a specific strategy. For those investments no environmental or social safeguards are applied.



Is a specific index designated as a reference benchmark to determine whether this financial product is aligned with the environmental and/or social characteristics that it promotes?

No reference benchmark has been designated for the purpose of attaining the environmental and/or social characteristics promoted by the Sub-Fund.

- How is the reference benchmark continuously aligned with each of the environmental or social characteristics promoted by the financial product?

Not applicable

- How is the alignment of the investment strategy with the methodology of the index ensured on a continuous basis?

Not applicable

- How does the designated index differ from a relevant broad market index?

Not applicable

- Where can the methodology used for the calculation of the designated index be found?

Not applicable

Reference benchmarks are indexes to measure whether the financial product attains the environmental or social characteristics that they promote.



Where can I find more product specific information online?

More product-specific information can be found on the website: <https://regulatory.allianzgi.com/SFDR>

Template pre-contractual disclosure for the financial products referred to in Article 8, paragraphs 1, 2 and 2a, of Regulation (EU) 2019/2088 and Article 6, first paragraph, of Regulation (EU) 2020/852

Product name:

Allianz Emerging Markets Equity SRI

Legal entity identifier: 5299008XMKNR6M71KE54

Environmental and/or social characteristics

Sustainable investment means an investment in an economic activity that contributes to an environmental or social objective, provided that the investment does not significantly harm any environmental or social objective and that the investee companies follow good governance practices.

The **EU Taxonomy** is a classification system laid down in Regulation (EU) 2020/852, establishing a list of **environmentally sustainable economic activities**. That Regulation does not include a list of socially sustainable economic activities. Sustainable investments with an environmental objective might be aligned with the Taxonomy or not.

Does this financial product have a sustainable investment objective?	
Yes	No
<input type="checkbox"/> It will make a minimum of sustainable investments with an environmental objective : ___% <input type="checkbox"/> in economic activities that qualify as environmentally sustainable under the EU Taxonomy <input type="checkbox"/> in economic activities that do not qualify as environmentally sustainable under the EU Taxonomy	<input checked="" type="checkbox"/> It promotes Environmental/Social (E/S) characteristics and while it does not have as its objective a sustainable investment, it will have a minimum proportion of 5.00% of sustainable investments <input checked="" type="checkbox"/> with an environmental objective in economic activities that qualify as environmentally sustainable under the EU Taxonomy <input checked="" type="checkbox"/> with an environmental objective in economic activities that do not qualify as environmentally sustainable under the EU Taxonomy <input checked="" type="checkbox"/> with a social objective
<input type="checkbox"/> It will make a minimum of sustainable investments with a social objective ___%	<input type="checkbox"/> It promotes E/S characteristics, but will not make any sustainable investments



What environmental and/or social characteristics are promoted by this financial product?

Allianz Emerging Markets Equity SRI (the "Sub-Fund") promotes environmental, social, human rights, governance, and business behaviour factors (this domain does not apply for sovereigns issued by a Sovereign Entity) through integration of a best-in-class approach into the Sub-Fund's investment process. This encompasses the evaluation of corporate or sovereign issuers based on an SRI Rating which is used to construct the portfolio.

In addition, sustainable minimum exclusion criteria apply and Sub-Fund specific exclusion criteria apply.

A reference benchmark has been designated for the purpose of attaining the environmental and/or social characteristics promoted by the Sub-Fund.

● What sustainability indicators are used to measure the attainment of each of the environmental or social characteristics promoted by this financial product?

To measure the attainment of the environmental and/or social characteristics the following sustainability indicators are used and reported on, at the fiscal year end:

- The actual percentage of the Sub-Fund's Portfolio (Portfolio in this respect does not comprise non-rated derivatives and instruments that are non-rated by nature (e. g., cash and deposits)) assets invested in best-in-class issuers (issuers with a minimum SRI Rating of 1 out of a scale from 0-4; 0 being the worst rating and 4 the best rating) is compared to the actual percentage of the benchmarks best-in-class issuers.
- Adherence to a 20% reduction of the investment universe.

Sustainability indicators measure how the environmental or social characteristics promoted by the financial product are attained.

- Confirmation that Principal Adverse Impacts (PAIs) of investment decisions on sustainability factors are considered through the application of exclusion criteria.

- **What are the objectives of the sustainable investments that the financial product partially intends to make and how does the sustainable investment contribute to such objectives?**

Sustainable investments contribute to environmental and/or social objectives, for which the Investment Manager uses as reference frameworks, among others, the UN Sustainable Development Goals (SDGs), as well as the objectives of the EU Taxonomy:

1. Climate Change Mitigation
2. Climate Change Adaptation
3. Sustainable Use and Protection of Water and Marine Resources
4. Transition to a Circular Economy
5. Pollution Prevention and Control
6. Protection and Restoration of Biodiversity and Ecosystems

The assessment of the positive contribution to the environmental or social objectives is based on a proprietary framework which combines quantitative elements with qualitative inputs from internal research. The methodology applies first a quantitative breakdown of a securities issuer into its business activities. The qualitative element of the framework is an assessment if business activities contribute positively to an environmental or a social objective.

To calculate the positive contribution on the Sub-Fund level the revenue share of each issuer attributable to business activities contributing to environmental and/or social objectives is considered provided the issuer is satisfying the Do No Significant Harm (“DNSH”) and Good Governance principles, and an asset-weighted aggregation is performed as a second step. Moreover, for certain types of securities, which finance specific projects contributing to environmental or social objectives the overall investment is considered to contribute to environmental and/or social objectives, but also for these a DNSH as well as a Good Governance check for issuers is performed.

- **How do the sustainable investments that the financial product partially intends to make, not cause significant harm to any environmental or social sustainable investment objective?**

In order to ensure that Sustainable Investments do not significantly harm any other environmental and/or social objective, the Investment Manager is leveraging the PAI indicators, whereby significance thresholds have been defined to identify significantly harmful issuers. Issuers not meeting the significance threshold can be engaged for a limited time period to remediate the adverse impact. Otherwise, if the issuer does not meet the defined significance thresholds twice subsequently or in case of a failed engagement, it does not pass the DNSH assessment. Investments in securities of issuers which do not pass the DNSH assessment are not counted as sustainable investments.

- *How have the indicators for adverse impacts on sustainability factors been taken into account?*

All mandatory PAI indicators are considered either as part of the application of the exclusion criteria or through thresholds on a sectorial or absolute basis. Significance thresholds have been defined and they refer to qualitative or quantitative criteria.

Recognizing the lack of data coverage for some of the PAI indicators equivalent data points are used to assess PAI indicators when applying the DNSH assessment, when relevant, for the following indicators for corporates: share of non-renewable energy consumption and production, activities negatively affecting biodiversity-sensitive areas, emissions to water, lack of processes and compliance mechanisms to monitor compliance with UNGC principles and OECD Guidelines for Multinational Enterprises; for sovereigns: GHG Intensity and investee countries subject to social violations. In case of securities which finance specific projects contributing to environmental or social objectives equivalent data at project level might be used to ensure that Sustainable Investments do not significantly harm any other environmental and/or social objective. The Investment Manager will strive to increase data coverage for PAI indicators with low data coverage by engaging with issuers and data providers. The Investment Manager will regularly evaluate whether the availability of data has increased sufficiently to potentially include assessment of such data in the investment process.

Principal adverse impacts are the most significant negative impacts of investment decisions on sustainability factors relating to environmental, social and employee matters, respect for human rights, anti-corruption and anti-bribery matters.

- *How are the sustainable investments aligned with the OECD Guidelines for Multinational Enterprises and the UN Guiding Principles on Business and Human Rights? Details:*

The Investment Manager's sustainable minimum exclusion list screens out companies based on their involvement in controversial practices against international norms. The core normative framework consists of the Principles of the UN Global Compact, the OECD Guidelines for Multinational Enterprises and the UN Guiding Principles for Business and Human Rights. Securities issued by companies having a severe violation of these frameworks will be restricted from the investment universe.

The EU Taxonomy sets out a "do not significant harm" principle by which Taxonomy-aligned investments should not significantly harm EU Taxonomy objectives and is accompanied by specific EU criteria.

The "do not significant harm" principle applies only to those investments underlying the financial product that take into account the EU criteria for environmentally sustainable economic activities. The investments underlying the remaining portion of this financial product do not take into account the EU criteria for environmentally sustainable economic activities.

Any other sustainable investments must also not significantly harm any environmental or social objectives.



Does this financial product consider principal adverse impacts on sustainability factors?

Yes

No

The Management Company has joined the Net Zero Asset Manager Initiative and considers PAI indicators through stewardship including engagement, both are relevant to mitigate potential adverse impact as a company.

Due to the commitment to the Net Zero Asset Manager Initiative, the Management Company aims to reduce greenhouse gas emissions in partnership with asset owner clients on decarbonisation goals, consistent with an ambition to reach net zero emission by 2050 or sooner across all assets under management. As part of this objective the Management Company will set an interim target for the proportion of assets to be managed in line with the attainment of net zero emissions by 2050 or sooner.

The Sub-Fund's Investment Manager considers PAI indicators regarding greenhouse gas emission, biodiversity, water, waste as well as social and employee matters for corporate issuers, and, where relevant, the freedom house index is applied to investments in sovereigns. PAI indicators are considered within the Investment Manager's investment process through the means of exclusions as described in the "binding elements" section of the Sub-Fund.

The data coverage for the data required for the PAI indicators is heterogenous. The data coverage related to biodiversity, water and waste is low and the related PAI indicators are considered through exclusion of securities issued by companies having a severe violation / breach of principles and guidelines such as the Principles of the United Nations Global Compact, the OECD Guidelines for Multinational Enterprises, and the United Nations Guiding Principles for Business and Human Rights on the grounds of problematic practices around human rights, labour rights, environment, and corruption issues. Therefore, the Investment Manager will strive to increase data coverage for PAI indicators with low data coverage. The Investment Manager will regularly evaluate whether the availability of data has increased sufficiently to potentially include assessment of such data in the investment process.

Additionally, PAI indicators are, among other sustainability factors, applied to derive the SRI Rating. The SRI Rating is used for the portfolio construction.

The following PAI indicators are considered:

Applicable to corporate issuers

- GHG Emissions
- Carbon footprint
- GHG Intensity of investee companies
- Exposure to companies active in the fossil fuel sector
- Activities negatively affecting biodiversity-sensitive areas
- Emissions to water
- Hazardous waste ratio

- Violation of UN Global compact principles
- Lack of processes and compliance mechanisms to monitor compliance with UN Global Compact principles
- Board gender diversity
- Exposure to controversial weapons

Applicable to sovereign and supranational issuers

- Investee countries subject to social violations

The information on the PAI indicators will be available in the end-year report of the Sub-Fund.



The investment strategy guides investment decisions based on factors such as investment objectives and risk tolerance.

What investment strategy does this financial product follow?

Allianz Emerging Markets Equity SRI's investment objective is to invest in Equities of global Emerging Markets in accordance with the Sustainable and Responsible Investment Strategy (SRI Strategy). The Investment Manager may engage in foreign currency overlay and thus assume separate foreign currency risks with regard to currencies of OECD member states, even if the Sub-Fund does not include any assets denominated in these respective currencies.

As part of the SRI best-in-class approach, the Sub-Fund takes environmental, social, human rights, governance, and business behaviour factors into account as follows:

- The aforesaid sustainability factors are analysed through SRI Research by the Investment Manager in order to assess how sustainable development and long-term issues are taken into account in the strategy of an issuer. SRI Research means the overall process of identifying potential risks as well as potential opportunities of an investment in securities of an issuer related to the analysis of sustainability factors. SRI Research data combines external research data (which might have some limitations) with internal analyses.
- Based on a combination of the results of the external and/or internal analyses of the sustainability factors, an internal rating is derived monthly (SRI Rating) and is afterwards assigned to a corporate or sovereign issuer.

This internal SRI Rating is used to rank and select or weight securities for the portfolio construction.

The Sub-Fund's general investment approach (Sub-Fund's applicable General Asset Class Principles in combination with its individual investment restrictions) is described in the prospectus.

● What are the binding elements of the investment strategy used to select the investments to attain each of the environmental or social characteristics promoted by this financial product?

The binding elements are:

- Minimum rating coverage: At least 90% of the Sub-Fund's portfolio is required to have an SRI Rating (portfolio in this respect does not comprise non-rated derivatives and instruments that are non-rated by nature e.g., cash and deposits). While most holdings of the Sub-Fund will have a corresponding SRI Rating some investments cannot be rated according to the SRI Research methodology. Examples of instruments not attaining to the SRI Rating include, but are not limited to cash, deposits, Target Funds, and non-rated investments.
- 80% of the rated instruments are adhering to the minimum rating threshold of 1 (out of a rating scale from 0 – 4; 0 being the worst rating and 4 the best rating).
- Reduction of investment universe by excluding at least 20% of issuers.
- Application of the below sustainable minimum exclusion criteria and Sub-Fund specific exclusion criteria.

The following sustainable minimum exclusion criteria for direct investments apply:

- securities issued by companies having a severe violation / breach of principles and guidelines such as the Principles of the United Nations Global Compact, the OECD Guidelines for Multinational Enterprises, and the United Nations Guiding Principles for Business and Human Rights on the grounds of problematic practices around human rights, labour rights, environment, and corruption issues,
- securities issued by companies involved in controversial weapons (anti-personnel mines, cluster munitions, chemical weapons, biological weapons, depleted uranium, white phosphorus, and nuclear weapons),

- securities issued by companies that derive more than 10% of their revenues from weapons, military equipment, and services,
- securities issued by companies that derive more than 10% of their revenue from thermal coal extraction,
- securities issued by utility companies that generate more than 20% of their revenues from coal,
- securities issued by companies involved in the production of tobacco, and securities issued by companies involved in the distribution of tobacco with more than 5% of their revenues.

The following Sub-Fund specific exclusion criteria for direct investments apply:

- Sub-fund assets may not be invested in Equities of issuers which are involved in the production of hydraulic fracturing and/or which provide services in relation to hydraulic fracturing of more than 5% of their revenues
- Sub-fund assets may not be invested in Equities of issuers which are involved in the production of alcohol (limited to spirits) of more than 10% of their revenues
- Sub-fund assets may not be invested in Equities of issuers which are involved in the production of agricultural genetically modified organisms -GMOs- of more than 5% of their revenues
- Sub-fund assets may not be invested in Equities of issuers which are involved in the production of nuclear power and/or which provide services in relation to nuclear power of more than 10% of their revenues
- Sub-fund assets may not be invested in Equities of issuers which are involved in the production of arctic drilling
- Sub-Fund assets may not be invested in Equities of issuers which are involved in the production of gambling and/or which are involved in the distribution/sales of gambling and/or which provide services in relation to gambling of more than 5% of their revenues
- Sub-Fund assets may not be invested in Equities of issuers which are involved in the production and/or exploration of oil sands of more than 5% of their revenues
- Sub-Fund assets may not be invested in Equities of issuers which are involved in the production of military equipment and services and/or which are involved in the distribution/sales of military equipment and services and/or which provide services in relation to military equipment and services of more than 5% of their revenues
- Sub-Fund assets may not be invested in Equities of issuers which are involved in the production of pornography of more than 1% of their revenues and/or which are involved in the distribution/sales of pornography of more than 1% of their revenues

Direct investments in sovereign issuers with an insufficient freedom house index score are excluded.

The sustainable minimum exclusion criteria are based on information from an external data provider and coded in pre- and post-trade compliance. The review is performed at least half yearly.

● **What is the committed minimum rate to reduce the scope of the investments considered prior to the application of that investment strategy?**

The Sub-Fund commits to reduce the investment universe by at least 20%.

● **What is the policy to assess good governance practices of the investee companies?**

Good governance principles are considered by screening out companies based on their involvement in controversies around international norms corresponding to the four good governance practices: sound management structures, employee relations, remuneration of staff and tax compliance. Companies having a severe violation in either of those areas will not be investible. For certain cases, flagged issuers shall be on a watch list. These companies will appear on this watch list when the Investment Manager believes that engagement may lead to improvements or when the company is assessed to take remedial actions. Companies on the watch list remain investible unless the Investment Manager believes that the engagement or the remedial actions of the company does not lead to the desired remedy of the severe controversy.

In addition, the Sub-Fund's Investment Manager is committed to actively encourage open dialogues with investee companies on corporate governance, proxy voting and broader sustainability issues in advance of shareholder meetings (regularly for direct investments in shares). The Sub-Fund's Investment Manager's

Good governance practices include sound management structures, employee relations, remuneration of staff and tax compliance.

approach to proxy voting and company engagement is set out in the Management Company's Stewardship Statement.



What is the asset allocation planned for this financial product?

Asset allocation describes the share of investments in specific assets.

Min. 90% of the Sub-Funds' assets (excluding cash and non-rated derivatives) are used to meet the environmental or social characteristics promoted by this Sub-Fund. A low portion of the Sub-Fund might contain assets which do not promote environmental or social characteristics. Examples of such instruments are derivatives, cash and deposits, some Target Funds and investment with temporarily divergent or absent environmental, social, or good governance qualifications. Min. 5% of the Sub-Funds' assets will be invested in Sustainable Investments. The minimum percentage of investments that are aligned with the EU Taxonomy is 0.01%. The Sub-Fund's Investment Manager does not commit to a minimum share of socially sustainable investments. While the Sub-Fund cannot commit to a minimum share of environmentally or socially sustainable investments, such investments may be freely allocated to within the Sub-Fund aggregated sustainable investment commitment disclosed (min. 5%).

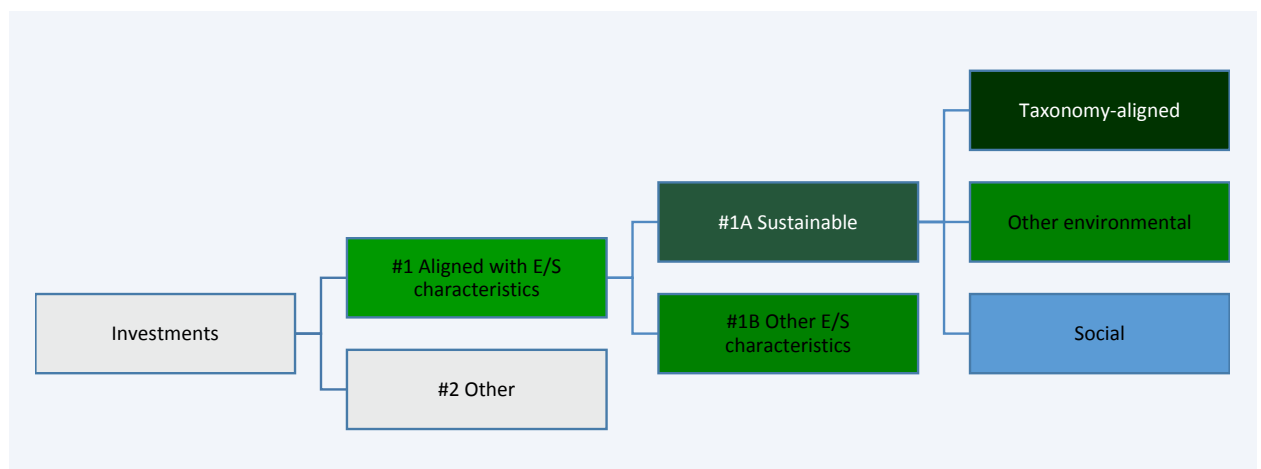

#1 Aligned with E/S characteristics includes the investments of the financial product used to attain the environmental or social characteristics promoted by the financial product.

#2 Other includes the remaining investments of the financial product which are neither aligned with the environmental or social characteristics, nor are qualified as sustainable investments.

The category **#1 Aligned with E/S characteristics** covers:

- The sub-category **#1A Sustainable** covers sustainable investments with environmental or social objectives.
- The sub-category **#1B Other E/S characteristics** covers investments aligned with the environmental or social characteristics that do not qualify as sustainable investments.

● How does the use of derivatives attain the environmental or social characteristics promoted by the financial product?

Not applicable



To what minimum extent are sustainable investments with an environmental objective aligned with the EU Taxonomy?

The Taxonomy-aligned investments include debt and/or equity in environmentally sustainable economic activities aligned with the EU-Taxonomy. The minimum percentage of investments that are aligned with the EU Taxonomy is 0.01%. Taxonomy-aligned data is provided by an external data provider. The Investment Manager has assessed the quality of such data. The data will not be subject to an assurance provided by auditors or a review by third parties. The data will not reflect any data in government bonds. As of today, there is no recognized methodology available to determine the proportion of Taxonomy-aligned activities when investing in government bonds.

Taxonomy-aligned activities in this disclosure are based on share of turnover. Pre-contractual figures use turnover as its financial metric as a default in line with the regulatory requirements and based on the fact that complete, verifiable or up-to date data for CAPEX and/or OPEX as financial metric is even less available.

Taxonomy-aligned data is only in rare cases data reported by companies in accordance with the EU Taxonomy. The data provider has derived Taxonomy-aligned data from other available equivalent public data.

Taxonomy-aligned activities are expressed as a share of:

- **turnover** reflecting the share of revenue from green activities of investee companies
- **capital expenditure** (CapEx) showing the green investments made by investee companies, e.g. for a transition to a green economy.
- **operational expenditure** (OpEx) reflecting green operational activities of investee companies.

● **Does the financial product invest in fossil gas and/or nuclear energy related activities that comply with the EU Taxonomy ¹?**

- Yes:
- In fossil gas
 - In nuclear energy
- No

The Sub-Fund does not pursue any investments in fossil gas and/or nuclear energy related activities that comply with the EU Taxonomy. Nevertheless, as result of this investment strategy, investments may occur in corporates which are also active in these activities. Further information will be provided as part of the annual reporting, if relevant.

The two graphs below show in green the minimum percentage of investments that are aligned with the EU Taxonomy. As there is no appropriate methodology to determine the Taxonomy-alignment of sovereign bonds*, the first graph shows the Taxonomy-alignment in relation to all the investments of the financial product including sovereign bonds, while the second graph shows the Taxonomy-alignment only in relation to the investments of the financial product other than sovereign bonds.

1. Taxonomy-alignment of investments including sovereign bonds*

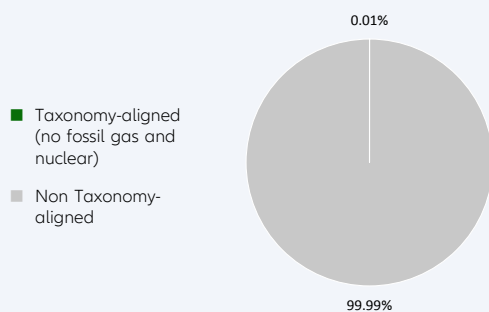

2. Taxonomy-alignment of investments excluding sovereign bonds*

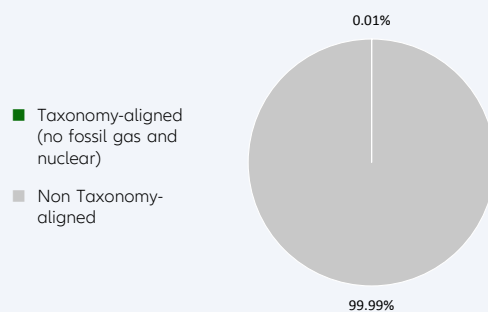

This graph represents X% of the total investments. It is noted that this Sub-Fund does not provide for a binding minimum quota for investments in sovereign bonds. Therefore, this Sub-Fund may have (but must not have) an exposure to sovereign bonds. In the absence of a binding minimum quota for investments in sovereign bonds, this graph does not generate any additional added value compared to the left-hand graph.

* For the purpose of these graphs, 'sovereign bonds' consist of all sovereign exposures

Enabling activities directly enable other activities to make a substantial contribution to an environmental objective.

Transitional activities are activities for which low-carbon alternatives are not yet available and among others have greenhouse gas emission levels corresponding to the best performance.

● **What is the minimum share of investments in transitional and enabling activities?**

The Sub-Fund's Investment Manager does not commit to a split of minimum taxonomy alignment into transitional, enabling activities and own performance.

¹ Fossil gas and/or nuclear related activities will only comply with the EU Taxonomy where they contribute to limiting climate change ("climate change mitigation") and do not significantly harm any EU Taxonomy objective - see explanatory note in the left hand margin. The full criteria for fossil gas and nuclear energy economic activities that comply with the EU Taxonomy are laid down in Commission Delegated Regulation (EU) 2022/1214.



What is the minimum share of sustainable investments with an environmental objective that are not aligned with the EU Taxonomy?

Taxonomy-aligned investments are considered a sub-category of Sustainable Investments. If an investment is not Taxonomy-aligned since the activity is not yet covered under the EU Taxonomy or the positive contribution is not substantial enough to comply with the Taxonomy technical screening criteria, the investment can still be considered an environmentally Sustainable Investment provided it complies with all criteria. The Investment Manager does not commit to a minimum share of environmentally Sustainable Investments that are not aligned with the EU Taxonomy. The overall sustainable investment share may also include investments with an environmental objective in economic activities that do not qualify as environmentally sustainable under the EU Taxonomy, and while the Sub-Fund cannot commit to a minimum share of environmentally or socially sustainable investments, such investments may be freely allocated to within the Sub-Fund aggregated sustainable investment commitment disclosed (min. 5%).



What is the minimum share of socially sustainable investments?

The Investment Manager defines Sustainable Investments based on internal research, which uses, among others, the UN Sustainable Development Goals (SDGs), as well as the objectives of the EU Taxonomy as reference frameworks. The Investment Manager does not commit to a minimum share of socially Sustainable Investments, as the SDGs contain environmental as well as social objectives. The overall sustainable investment share may also include investments with a social objective, and while the Sub-Fund cannot commit to a minimum share of environmentally or socially sustainable investments, such investments may be freely allocated to within the Sub-Fund aggregated sustainable investment commitment disclosed (min. 5%).



What investments are included under “#2 Other”, what is their purpose and are there any minimum environmental or social safeguards?

Under “#2 Other” investments into cash, Target Funds, or derivatives can be included. Derivatives might be used for efficient portfolio management (including risk hedging) and/or investment purposes, and Target Funds to benefit from a specific strategy. For those investments no environmental or social safeguards are applied.



Is a specific index designated as a reference benchmark to determine whether this financial product is aligned with the environmental and/or social characteristics that it promotes?

Yes, the Sub-Fund has assigned MSCI Emerging Markets Ext. SRI 5% Issuer Capped Total Return Net as benchmark.

● How is the reference benchmark continuously aligned with each of the environmental or social characteristics promoted by the financial product?

The Sub-Fund uses an SRI benchmark which is however not completely aligned with the environmental or social characteristics promoted by the sub-fund. The MSCI Emerging Markets SRI 5% Issuer Capped Index captures large and mid cap stocks across 24 Emerging Markets (EM) countries. The Index is a capitalization weighted index that provides exposure to companies with outstanding Environmental, Social and Governance (ESG) ratings and excludes companies whose products have negative social or environmental impacts.

● How is the alignment of the investment strategy with the methodology of the index ensured on a continuous basis?

The benchmark is not continuously aligned as the screening and exclusion criteria of the benchmark deviate from the Sub-Fund's investment strategy.

● How does the designated index differ from a relevant broad market index?

The benchmark uses ESG criteria as well as exclusion criteria for index construction.



are sustainable investments with an environmental objective that **do not take into account the criteria** for environmentally sustainable economic activities under the EU Taxonomy.

Reference benchmarks are indexes to measure whether the financial product attains the environmental or social characteristics that they promote.

- **Where can the methodology used for the calculation of the designated index be found?**

Details of the Benchmarks' methodology may be found at <https://www.msci.com/documents/10199/f999c363-a604-415a-baa9-8cf9fe05f1e0> or at www.msci.com



Where can I find more product specific information online?

More product-specific information can be found on the website: <https://regulatory.allianzgi.com/SFDR>

Template pre-contractual disclosure for the financial products referred to in Article 8, paragraphs 1, 2 and 2a, of Regulation (EU) 2019/2088 and Article 6, first paragraph, of Regulation (EU) 2020/852

Product name:

Allianz Emerging Markets SRI Bond

Legal entity identifier: 529900V4JP0EVDIGZD94

Environmental and/or social characteristics

Sustainable investment means an investment in an economic activity that contributes to an environmental or social objective, provided that the investment does not significantly harm any environmental or social objective and that the investee companies follow good governance practices.

The **EU Taxonomy** is a classification system laid down in Regulation (EU) 2020/852, establishing a list of **environmentally sustainable economic activities**. That Regulation does not include a list of socially sustainable economic activities. Sustainable investments with an environmental objective might be aligned with the Taxonomy or not.

Does this financial product have a sustainable investment objective?

<input checked="" type="radio"/> <input checked="" type="radio"/> Yes		<input checked="" type="radio"/> <input type="radio"/> No	
<input type="checkbox"/> It will make a minimum of sustainable investments with an environmental objective : ____%	<input checked="" type="checkbox"/> It promotes Environmental/Social (E/S) characteristics and while it does not have as its objective a sustainable investment, it will have a minimum proportion of 5.00% of sustainable investments	<input type="checkbox"/> in economic activities that qualify as environmentally sustainable under the EU Taxonomy	<input checked="" type="checkbox"/> with an environmental objective in economic activities that qualify as environmentally sustainable under the EU Taxonomy
<input type="checkbox"/> in economic activities that do not qualify as environmentally sustainable under the EU Taxonomy	<input checked="" type="checkbox"/> with an environmental objective in economic activities that do not qualify as environmentally sustainable under the EU Taxonomy	<input type="checkbox"/> It will make a minimum of sustainable investments with a social objective ____%	<input checked="" type="checkbox"/> with a social objective
<input type="checkbox"/> It promotes E/S characteristics, but will not make any sustainable investments			



What environmental and/or social characteristics are promoted by this financial product?

Allianz Emerging Markets SRI Bond (the "Sub-Fund") promotes environmental, social, human rights, governance, and business behaviour factors (this domain does not apply for sovereigns issued by a Sovereign Entity) through integration of a best-in-class approach into the Sub-Fund's investment process. This encompasses the evaluation of corporate or sovereign issuers based on an SRI Rating which is used to construct the portfolio.

In addition, sustainable minimum exclusion criteria and Sub-Fund specific exclusion criteria apply.

A reference benchmark has been designated for the purpose of attaining the environmental and/or social characteristics promoted by the Sub-Fund.

● What sustainability indicators are used to measure the attainment of each of the environmental or social characteristics promoted by this financial product?

To measure the attainment of the environmental and/or social characteristics the following sustainability indicators are used and reported on, at the fiscal year end:

- Adherence to a 20% reduction of the investment universe.
- Confirmation that Principal Adverse Impacts (PAIs) of investment decisions on sustainability factors are considered through the application of exclusion criteria.

Sustainability indicators measure how the environmental or social characteristics promoted by the financial product are attained.

- **What are the objectives of the sustainable investments that the financial product partially intends to make and how does the sustainable investment contribute to such objectives?**

Sustainable investments contribute to environmental and/or social objectives, for which the Investment Manager uses as reference frameworks, among others, the UN Sustainable Development Goals (SDGs), as well as the objectives of the EU Taxonomy:

1. Climate Change Mitigation
2. Climate Change Adaptation
3. Sustainable Use and Protection of Water and Marine Resources
4. Transition to a Circular Economy
5. Pollution Prevention and Control
6. Protection and Restoration of Biodiversity and Ecosystems

The assessment of the positive contribution to the environmental or social objectives is based on a proprietary framework which combines quantitative elements with qualitative inputs from internal research. The methodology applies first a quantitative breakdown of a securities issuer into its business activities. The qualitative element of the framework is an assessment if business activities contribute positively to an environmental or a social objective.

To calculate the positive contribution on the Sub-Fund level the revenue share of each issuer attributable to business activities contributing to environmental and/or social objectives is considered provided the issuer is satisfying the Do No Significant Harm ("DNSH") and Good Governance principles, and an asset-weighted aggregation is performed as a second step. Moreover, for certain types of securities, which finance specific projects contributing to environmental or social objectives the overall investment is considered to contribute to environmental and/or social objectives, but also for these a DNSH as well as a Good Governance check for issuers is performed.

- **How do the sustainable investments that the financial product partially intends to make, not cause significant harm to any environmental or social sustainable investment objective?**

In order to ensure that Sustainable Investments do not significantly harm any other environmental and/or social objective, the Investment Manager is leveraging the PAI indicators, whereby significance thresholds have been defined to identify significantly harmful issuers. Issuers not meeting the significance threshold can be engaged for a limited time period to remediate the adverse impact. Otherwise, if the issuer does not meet the defined significance thresholds twice subsequently or in case of a failed engagement, it does not pass the DNSH assessment. Investments in securities of issuers which do not pass the DNSH assessment are not counted as sustainable investments.

- *How have the indicators for adverse impacts on sustainability factors been taken into account?*

All mandatory PAI indicators are considered either as part of the application of the exclusion criteria or through thresholds on a sectorial or absolute basis. Significance thresholds have been defined and they refer to qualitative or quantitative criteria.

Recognizing the lack of data coverage for some of the PAI indicators equivalent data points are used to assess PAI indicators when applying the DNSH assessment, when relevant, for the following indicators for corporates: share of non-renewable energy consumption and production, activities negatively affecting biodiversity-sensitive areas, emissions to water, lack of processes and compliance mechanisms to monitor compliance with UNGC principles and OECD Guidelines for Multinational Enterprises; for sovereigns: GHG Intensity and investee countries subject to social violations. In case of securities which finance specific projects contributing to environmental or social objectives equivalent data at project level might be used to ensure that Sustainable Investments do not significantly harm any other environmental and/or social objective. The Investment Manager will strive to increase data coverage for PAI indicators with low data coverage by engaging with issuers and data providers. The Investment Manager will regularly evaluate whether the availability of data has increased sufficiently to potentially include assessment of such data in the investment process.

- *How are the sustainable investments aligned with the OECD Guidelines for Multinational Enterprises and the UN Guiding Principles on Business and Human Rights? Details:*

The Investment Manager's sustainable minimum exclusion list screens out companies based on their involvement in controversial practices against international norms. The core normative framework consists of the Principles of the UN Global Compact, the OECD Guidelines for Multinational Enterprises

Principal adverse impacts are the most significant negative impacts of investment decisions on sustainability factors relating to environmental, social and employee matters, respect for human rights, anti-corruption and anti-bribery matters.

and the UN Guiding Principles for Business and Human Rights. Securities issued by companies having a severe violation of these frameworks will be restricted from the investment universe.

The EU Taxonomy sets out a “do not significant harm” principle by which Taxonomy-aligned investments should not significantly harm EU Taxonomy objectives and is accompanied by specific EU criteria.

The “do not significant harm” principle applies only to those investments underlying the financial product that take into account the EU criteria for environmentally sustainable economic activities. The investments underlying the remaining portion of this financial product do not take into account the EU criteria for environmentally sustainable economic activities.

Any other sustainable investments must also not significantly harm any environmental or social objectives.



Does this financial product consider principal adverse impacts on sustainability factors?

Yes

No

The Management Company has joined the Net Zero Asset Manager Initiative and considers PAI indicators through stewardship including engagement, both are relevant to mitigate potential adverse impact as a company.

Due to the commitment to the Net Zero Asset Manager Initiative, the Management Company aims to reduce greenhouse gas emissions in partnership with asset owner clients on decarbonisation goals, consistent with an ambition to reach net zero emission by 2050 or sooner across all assets under management. As part of this objective the Management Company will set an interim target for the proportion of assets to be managed in line with the attainment of net zero emissions by 2050 or sooner.

The Sub-Fund’s Investment Manager considers PAI indicators regarding greenhouse gas emission, biodiversity, water, waste as well as social and employee matters for corporate issuers, and, where relevant, the freedom house index is applied to investments in sovereigns. PAI indicators are considered within the Investment Manager’s investment process through the means of exclusions as described in the “binding elements” section of the Sub-Fund.

The data coverage for the data required for the PAI indicators is heterogenous. The data coverage related to biodiversity, water and waste is low and the related PAI indicators are considered through exclusion of securities issued by companies having a severe violation / breach of principles and guidelines such as the Principles of the United Nations Global Compact, the OECD Guidelines for Multinational Enterprises, and the United Nations Guiding Principles for Business and Human Rights on the grounds of problematic practices around human rights, labour rights, environment, and corruption issues. Therefore, the Investment Manager will strive to increase data coverage for PAI indicators with low data coverage. The Investment Manager will regularly evaluate whether the availability of data has increased sufficiently to potentially include assessment of such data in the investment process.

Additionally, PAI indicators are, among other sustainability factors, applied to derive the SRI Rating. The SRI Rating is used for the portfolio construction.

The following PAI indicators are considered:

Applicable to corporate issuers

- GHG Emissions
- Carbon footprint
- GHG Intensity of investee companies
- Exposure to companies active in the fossil fuel sector
- Activities negatively affecting biodiversity-sensitive areas
- Emissions to water
- Hazardous waste ratio
- Violation of UN Global compact principles
- Lack of processes and compliance mechanisms to monitor compliance with UN Global Compact principles
- Board gender diversity
- Exposure to controversial weapons

Applicable to sovereign and supranational issuers

- Investee countries subject to social violations

The information on the PAI indicators will be available in the end-year report of the Sub-Fund.



The investment strategy guides investment decisions based on factors such as investment objectives and risk tolerance.

What investment strategy does this financial product follow?

Allianz Emerging Markets SRI Bond's investment objective is to invest in sovereign and quasi-sovereign Debt Securities of global Emerging Markets in accordance with the Sustainable and Responsible Investment Strategy (SRI Strategy).

As part of the SRI best-in-class approach, the Sub-Fund takes environmental, social, human rights, governance, and business behaviour factors into account as follows:

- The aforesaid sustainability factors are analysed through SRI Research by the Investment Manager in order to assess how sustainable development and long-term issues are taken into account in the strategy of an issuer. SRI Research means the overall process of identifying potential risks as well as potential opportunities of an investment in securities of an issuer related to the analysis of sustainability factors. SRI Research data combines external research data (which might have some limitations) with internal analyses.
- Based on a combination of the results of the external and/or internal analyses of the sustainability factors, an internal rating is derived monthly (SRI Rating) and is afterwards assigned to a corporate or sovereign issuer.

This internal SRI Rating is used to rank and select or weight securities for the portfolio construction.

The Sub-Fund's general investment approach (Sub-Fund's applicable General Asset Class Principles in combination with its individual investment restrictions) is described in the prospectus.

● What are the binding elements of the investment strategy used to select the investments to attain each of the environmental or social characteristics promoted by this financial product?

The binding elements are:

- Minimum rating coverage: At least 90% of Sub-Fund's portfolio are required to have an SRI Rating (Portfolio in this respect does not comprise non-rated derivatives and instruments that are non-rated by nature (e.g., cash and deposits)). While most holdings of Sub-Funds will have a corresponding SRI Rating some investments cannot be rated according to the SRI Research methodology. Examples of instruments not attaining to the SRI Rating include, but are not limited to cash, deposits, Target Funds and non-rated investments.
- Reduction of investment universe by excluding at least 20% of issuers.
- Application of the following sustainable minimum exclusion criteria for direct investments:
 - securities issued by companies having a severe violation / breach of principles and guidelines such as the Principles of the United Nations Global Compact, the OECD Guidelines for Multinational Enterprises, and the United Nations Guiding Principles for Business and Human Rights on the grounds of problematic practices around human rights, labour rights, environment, and corruption issues,
 - securities issued by companies involved in controversial weapons (anti-personnel mines, cluster munitions, chemical weapons, biological weapons, depleted uranium, white phosphorus, and nuclear weapons),
 - securities issued by companies that derive more than 10% of their revenues from weapons, military equipment, and services,
 - securities issued by companies that derive more than 10% of their revenue from thermal coal extraction,
 - securities issued by utility companies that generate more than 20% of their revenues from coal,
 - securities issued by companies involved in the production of tobacco, and securities issued by companies involved in the distribution of tobacco with more than 5% of their revenues.

For direct investments in sovereign issuers, an internal scoring model weighting various environmental, social and governance factors is applied for which Freedom House Index is considered as one criterion amongst further criteria. Debt Securities of issuers other than sovereign issuers may not be acquired if the respective issuer's country does not meet the requirements of the aforesaid internal scoring model.

The sustainable minimum exclusion criteria are based on information from an external data provider and coded in pre- and post-trade compliance. The review is performed at least half yearly.

- **What is the committed minimum rate to reduce the scope of the investments considered prior to the application of that investment strategy?**

The Sub-Fund commits to reduce the investment universe by at least 20%.

- **What is the policy to assess good governance practices of the investee companies?**

Good governance principles are considered by screening out companies based on their involvement in controversies around international norms corresponding to the four good governance practices: sound management structures, employee relations, remuneration of staff and tax compliance. Companies having a severe violation in either of those areas will not be investible. For certain cases, flagged issuers shall be on a watch list. These companies will appear on this watch list when the Investment Manager believes that engagement may lead to improvements or when the company is assessed to take remedial actions. Companies on the watch list remain investible unless the Investment Manager believes that the engagement or the remedial actions of the company does not lead to the desired remedy of the severe controversy.

In addition, the Sub-Fund's Investment Manager is committed to actively encourage open dialogues with investee companies on corporate governance, proxy voting and broader sustainability issues in advance of shareholder meetings (regularly for direct investments in shares). The Sub-Fund's Investment Manager's approach to proxy voting and company engagement is set out in the Management Company's Stewardship Statement.

Good governance practices include sound management structures, employee relations, remuneration of staff and tax compliance.



What is the asset allocation planned for this financial product?

Asset allocation describes the share of investments in specific assets.

Min. 90% of the Sub-Funds' assets (excluding cash and non-rated derivatives) are used to meet the environmental or social characteristics promoted by this Sub-Fund. A low portion of the Sub-Fund might contain assets which do not promote environmental or social characteristics. Examples of such instruments are derivatives, cash and deposits, some Target Funds and investment with temporarily divergent or absent environmental, social, or good governance qualifications. Min. 5% of the Sub-Funds' assets will be invested in Sustainable Investments. The minimum percentage of investments that are aligned with the EU Taxonomy is 0.01%. The Sub-Fund's Investment Manager does not commit to a minimum share of environmentally Sustainable Investments that are not aligned with the EU Taxonomy. The Sub-Fund's Investment Manager does not commit to a minimum share of socially sustainable investments. While the Sub-Fund cannot commit to a minimum share of environmentally or socially sustainable investments, such investments may be freely allocated to within the Sub-Fund aggregated sustainable investment commitment disclosed (min. 5%).

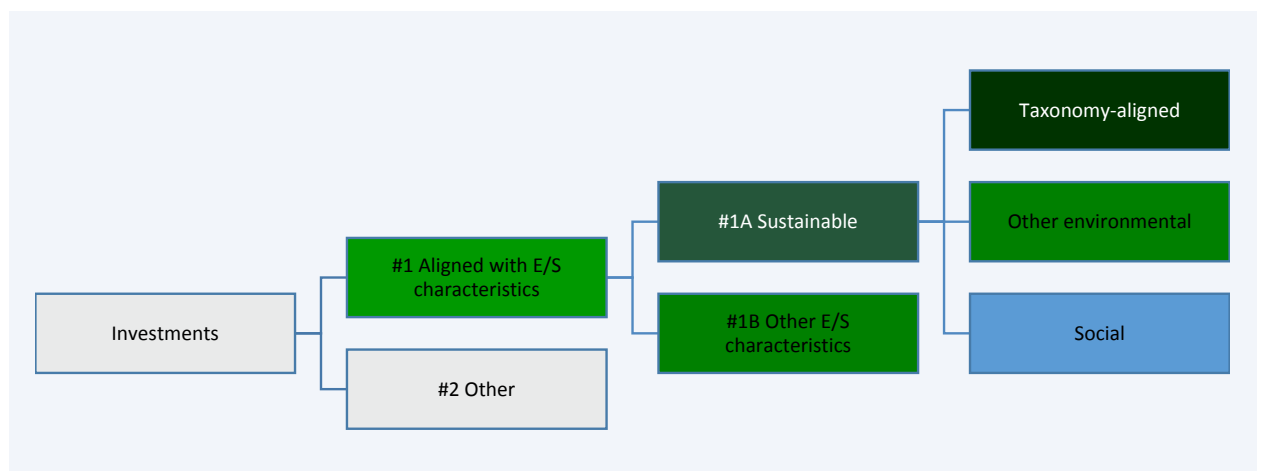

#1 Aligned with E/S characteristics includes the investments of the financial product used to attain the environmental or social characteristics promoted by the financial product.

#2 Other includes the remaining investments of the financial product which are neither aligned with the environmental or social characteristics, nor are qualified as sustainable investments.

The category **#1 Aligned with E/S characteristics** covers:

- The sub-category **#1A Sustainable** covers sustainable investments with environmental or social objectives.
- The sub-category **#1B Other E/S characteristics** covers investments aligned with the environmental or social characteristics that do not qualify as sustainable investments.

- How does the use of derivatives attain the environmental or social characteristics promoted by the financial product?

Not applicable



To what minimum extent are sustainable investments with an environmental objective aligned with the EU Taxonomy?

The Taxonomy-aligned investments include debt and/or equity in environmentally sustainable economic activities aligned with the EU-Taxonomy. The minimum percentage of investments that are aligned with the EU Taxonomy is 0.01%. Taxonomy-aligned data is provided by an external data provider. The Investment Manager has assessed the quality of such data. The data will not be subject to an assurance provided by auditors or a review by third parties. The data will not reflect any data in government bonds. As of today, there is no recognized methodology available to determine the proportion of Taxonomy-aligned activities when investing in government bonds.

Taxonomy-aligned activities in this disclosure are based on share of turnover. Pre-contractual figures use turnover as its financial metric as a default in line with the regulatory requirements and based on the fact that complete, verifiable or up-to date data for CAPEX and/or OPEX as financial metric is even less available.

Taxonomy-aligned data is only in rare cases data reported by companies in accordance with the EU Taxonomy. The data provider has derived Taxonomy-aligned data from other available equivalent public data.

- Does the financial product invest in fossil gas and/or nuclear energy related activities that comply with the EU Taxonomy ¹?

- Yes:
- In fossil gas
 - In nuclear energy
- No

The Sub-Fund does not pursue any investments in fossil gas and/or nuclear energy related activities that comply with the EU Taxonomy. Nevertheless, as result of this investment strategy, investments may occur in corporates which are also active in these activities. Further information will be provided as part of the annual reporting, if relevant.

The two graphs below show in green the minimum percentage of investments that are aligned with the EU Taxonomy. As there is no appropriate methodology to determine the Taxonomy-alignment of sovereign bonds^{*}, the first graph shows the Taxonomy-alignment in relation to all the investments of the financial product including sovereign bonds, while the second graph shows the Taxonomy-alignment only in relation to the investments of the financial product other than sovereign bonds.

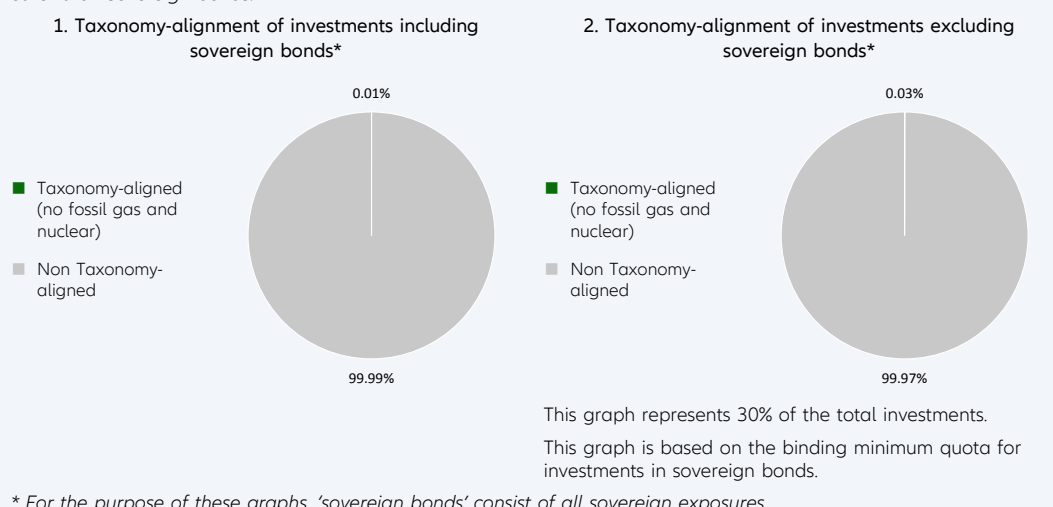

Taxonomy-aligned activities are expressed as a share of:

- **turnover** reflecting the share of revenue from green activities of investee companies
- **capital expenditure (CapEx)** showing the green investments made by investee companies, e.g. for a transition to a green economy.
- **operational expenditure (OpEx)** reflecting green operational activities of investee companies.

¹ Fossil gas and/or nuclear related activities will only comply with the EU Taxonomy where they contribute to limiting climate change ("climate change mitigation") and do not significantly harm any EU Taxonomy objective - see explanatory note in the left hand margin. The full criteria for fossil gas and nuclear energy economic activities that comply with the EU Taxonomy are laid down in Commission Delegated Regulation (EU) 2022/1214.

Enabling activities directly enable other activities to make a substantial contribution to an environmental objective.

Transitional activities are activities for which low-carbon alternatives are not yet available and among others have greenhouse gas emission levels corresponding to the best performance.

● **What is the minimum share of investments in transitional and enabling activities?**

The Sub-Fund's Investment Manager does not commit to a split of minimum taxonomy alignment into transitional, enabling activities and own performance.



What is the minimum share of sustainable investments with an environmental objective that are not aligned with the EU Taxonomy?

Taxonomy-aligned investments are considered a sub-category of Sustainable Investments. If an investment is not Taxonomy-aligned since the activity is not yet covered under the EU Taxonomy or the positive contribution is not substantial enough to comply with the Taxonomy technical screening criteria, the investment can still be considered an environmentally Sustainable Investment provided it complies with all criteria. The Investment Manager does not commit to a minimum share of environmentally Sustainable Investments that are not aligned with the EU Taxonomy. The overall sustainable investment share may also include investments with an environmental objective in economic activities that do not qualify as environmentally sustainable under the EU Taxonomy, and while the Sub-Fund cannot commit to a minimum share of environmentally or socially sustainable investments, such investments may be freely allocated to within the Sub-Fund aggregated sustainable investment commitment disclosed (min. 5%).



are sustainable investments with an environmental objective that **do not take into account the criteria** for environmentally sustainable economic activities under the EU Taxonomy.



What is the minimum share of socially sustainable investments?

The Investment Manager defines Sustainable Investments based on internal research, which uses, among others, the UN Sustainable Development Goals (SDGs), as well as the objectives of the EU Taxonomy as reference frameworks. The Investment Manager does not commit to a minimum share of socially Sustainable Investments, as the SDGs contain environmental as well as social objectives. The overall sustainable investment share may also include investments with a social objective, and while the Sub-Fund cannot commit to a minimum share of environmentally or socially sustainable investments, such investments may be freely allocated to within the Sub-Fund aggregated sustainable investment commitment disclosed (min. 5%).



What investments are included under “#2 Other”, what is their purpose and are there any minimum environmental or social safeguards?

Under “#2 Other” investments into cash, Target Funds, or derivatives can be included. Derivatives might be used for efficient portfolio management (including risk hedging) and/or investment purposes, and Target Funds to benefit from a specific strategy. For those investments no environmental or social safeguards are applied.



Is a specific index designated as a reference benchmark to determine whether this financial product is aligned with the environmental and/or social characteristics that it promotes?

Yes, the Sub-Fund has assigned J.P. MORGAN ESG Emerging Market Bond (EMBI) Global Diversified Total Return as benchmark.

Reference benchmarks are indexes to measure whether the financial product attains the environmental or social characteristics that they promote.

- **How is the reference benchmark continuously aligned with each of the environmental or social characteristics promoted by the financial product?**

The Sub-Fund uses an ESG benchmark which is however not completely aligned with the environmental or social characteristics promoted by the sub-fund. The Benchmark applies an ESG scoring and screening methodology to tilt toward issuers ranked higher on ESG criteria and green bond, and to underweight and remove issuers that rank lower.

- **How is the alignment of the investment strategy with the methodology of the index ensured on a continuous basis?**

The benchmark is not continuously aligned as the screening and exclusion criteria of the benchmark deviate from the Sub-Fund's investment strategy.

- **How does the designated index differ from a relevant broad market index?**

The benchmark uses ESG criteria as well as exclusion criteria for index construction.

- **Where can the methodology used for the calculation of the designated index be found?**

Details of the Benchmarks' methodology may be found at <https://www.jpmorgan.com/content/dam/jpm/cib/complex/content/markets/composition-docs/pdf-30.pdf> or at www.jpmorgan.com



Where can I find more product specific information online?

More product-specific information can be found on the website: <https://regulatory.allianzgi.com/SFDR>

Template pre-contractual disclosure for the financial products referred to in Article 8, paragraphs 1, 2 and 2a, of Regulation (EU) 2019/2088 and Article 6, first paragraph, of Regulation (EU) 2020/852

Product name:

Allianz Emerging Markets SRI Corporate Bond

Legal entity identifier: 529900G3RBZLNLUYXA43

Environmental and/or social characteristics

Sustainable investment means an investment in an economic activity that contributes to an environmental or social objective, provided that the investment does not significantly harm any environmental or social objective and that the investee companies follow good governance practices.

The **EU Taxonomy** is a classification system laid down in Regulation (EU) 2020/852, establishing a list of **environmentally sustainable economic activities**. That Regulation does not include a list of socially sustainable economic activities. Sustainable investments with an environmental objective might be aligned with the Taxonomy or not.

Does this financial product have a sustainable investment objective?

<input checked="" type="radio"/> <input checked="" type="radio"/> Yes		<input checked="" type="radio"/> <input type="radio"/> No	
<input type="checkbox"/> It will make a minimum of sustainable investments with an environmental objective : ____%	<input type="checkbox"/> in economic activities that qualify as environmentally sustainable under the EU Taxonomy	<input checked="" type="checkbox"/> It promotes Environmental/Social (E/S) characteristics and while it does not have as its objective a sustainable investment, it will have a minimum proportion of 5.00% of sustainable investments	<input checked="" type="checkbox"/> with an environmental objective in economic activities that qualify as environmentally sustainable under the EU Taxonomy
<input type="checkbox"/> in economic activities that do not qualify as environmentally sustainable under the EU Taxonomy	<input type="checkbox"/> It will make a minimum of sustainable investments with a social objective ____%	<input checked="" type="checkbox"/> with an environmental objective in economic activities that do not qualify as environmentally sustainable under the EU Taxonomy	<input checked="" type="checkbox"/> with a social objective
<input type="checkbox"/> It will make a minimum of sustainable investments with a social objective ____%	<input type="checkbox"/> It promotes E/S characteristics, but will not make any sustainable investments		



What environmental and/or social characteristics are promoted by this financial product?

Allianz Emerging Markets SRI Corporate Bond (the "Sub-Fund") promotes environmental, social, human rights, governance, and business behaviour factors (this domain does not apply for sovereigns issued by a Sovereign Entity) through integration of a best-in-class approach into the Sub-Fund's investment process. This encompasses the evaluation of corporate or sovereign issuers based on an SRI Rating which is used to construct the portfolio.

In addition, sustainable minimum exclusion criteria and Sub-Fund specific exclusion criteria apply.

A reference benchmark has been designated for the purpose of attaining the environmental and/or social characteristics promoted by the Sub-Fund.

● What sustainability indicators are used to measure the attainment of each of the environmental or social characteristics promoted by this financial product?

To measure the attainment of the environmental and/or social characteristics the following sustainability indicators are used and reported on, at the fiscal year end:

- The actual percentage of the Sub-Fund's Portfolio (Portfolio in this respect does not comprise non-rated derivatives and instruments that are non-rated by nature (e. g., cash and deposits)) assets invested in best-in-class issuers (issuers with a minimum SRI Rating of 2 out of a scale from 0-4; 0 being the worst rating and 4 the best rating) is compared to the actual percentage of the benchmarks best-in-class issuers.
- Adherence to a 20% reduction of the investment universe.

Sustainability indicators measure how the environmental or social characteristics promoted by the financial product are attained.

- Confirmation that Principal Adverse Impacts (PAIs) of investment decisions on sustainability factors are considered through the application of exclusion criteria

- **What are the objectives of the sustainable investments that the financial product partially intends to make and how does the sustainable investment contribute to such objectives?**

Sustainable investments contribute to environmental and/or social objectives, for which the Investment Manager uses as reference frameworks, among others, the UN Sustainable Development Goals (SDGs), as well as the objectives of the EU Taxonomy:

1. Climate Change Mitigation
2. Climate Change Adaptation
3. Sustainable Use and Protection of Water and Marine Resources
4. Transition to a Circular Economy
5. Pollution Prevention and Control
6. Protection and Restoration of Biodiversity and Ecosystems

The assessment of the positive contribution to the environmental or social objectives is based on a proprietary framework which combines quantitative elements with qualitative inputs from internal research. The methodology applies first a quantitative breakdown of a securities issuer into its business activities. The qualitative element of the framework is an assessment if business activities contribute positively to an environmental or a social objective.

To calculate the positive contribution on the Sub-Fund level the revenue share of each issuer attributable to business activities contributing to environmental and/or social objectives is considered provided the issuer is satisfying the Do No Significant Harm (“DNSH”) and Good Governance principles, and an asset-weighted aggregation is performed as a second step. Moreover, for certain types of securities, which finance specific projects contributing to environmental or social objectives the overall investment is considered to contribute to environmental and/or social objectives, but also for these a DNSH as well as a Good Governance check for issuers is performed.

- **How do the sustainable investments that the financial product partially intends to make, not cause significant harm to any environmental or social sustainable investment objective?**

In order to ensure that Sustainable Investments do not significantly harm any other environmental and/or social objective, the Investment Manager is leveraging the PAI indicators, whereby significance thresholds have been defined to identify significantly harmful issuers. Issuers not meeting the significance threshold can be engaged for a limited time period to remediate the adverse impact. Otherwise, if the issuer does not meet the defined significance thresholds twice subsequently or in case of a failed engagement, it does not pass the DNSH assessment. Investments in securities of issuers which do not pass the DNSH assessment are not counted as sustainable investments.

- *How have the indicators for adverse impacts on sustainability factors been taken into account?*

All mandatory PAI indicators are considered either as part of the application of the exclusion criteria or through thresholds on a sectorial or absolute basis. Significance thresholds have been defined and they refer to qualitative or quantitative criteria.

Recognizing the lack of data coverage for some of the PAI indicators equivalent data points are used to assess PAI indicators when applying the DNSH assessment, when relevant, for the following indicators for corporates: share of non-renewable energy consumption and production, activities negatively affecting biodiversity-sensitive areas, emissions to water, lack of processes and compliance mechanisms to monitor compliance with UNGC principles and OECD Guidelines for Multinational Enterprises; for sovereigns: GHG Intensity and investee countries subject to social violations. In case of securities which finance specific projects contributing to environmental or social objectives equivalent data at project level might be used to ensure that Sustainable Investments do not significantly harm any other environmental and/or social objective. The Investment Manager will strive to increase data coverage for PAI indicators with low data coverage by engaging with issuers and data providers. The Investment Manager will regularly evaluate whether the availability of data has increased sufficiently to potentially include assessment of such data in the investment process.

Principal adverse impacts are the most significant negative impacts of investment decisions on sustainability factors relating to environmental, social and employee matters, respect for human rights, anti-corruption and anti-bribery matters.

- *How are the sustainable investments aligned with the OECD Guidelines for Multinational Enterprises and the UN Guiding Principles on Business and Human Rights? Details:*

The Investment Manager's sustainable minimum exclusion list screens out companies based on their involvement in controversial practices against international norms. The core normative framework consists of the Principles of the UN Global Compact, the OECD Guidelines for Multinational Enterprises and the UN Guiding Principles for Business and Human Rights. Securities issued by companies having a severe violation of these frameworks will be restricted from the investment universe.

The EU Taxonomy sets out a "do not significant harm" principle by which Taxonomy-aligned investments should not significantly harm EU Taxonomy objectives and is accompanied by specific EU criteria.

The "do not significant harm" principle applies only to those investments underlying the financial product that take into account the EU criteria for environmentally sustainable economic activities. The investments underlying the remaining portion of this financial product do not take into account the EU criteria for environmentally sustainable economic activities.

Any other sustainable investments must also not significantly harm any environmental or social objectives.



Does this financial product consider principal adverse impacts on sustainability factors?

Yes

No

The Management Company has joined the Net Zero Asset Manager Initiative and considers PAI indicators through stewardship including engagement, both are relevant to mitigate potential adverse impact as a company.

Due to the commitment to the Net Zero Asset Manager Initiative, the Management Company aims to reduce greenhouse gas emissions in partnership with asset owner clients on decarbonisation goals, consistent with an ambition to reach net zero emission by 2050 or sooner across all assets under management. As part of this objective the Management Company will set an interim target for the proportion of assets to be managed in line with the attainment of net zero emissions by 2050 or sooner.

The Sub-Fund's Investment Manager considers PAI indicators regarding greenhouse gas emission, biodiversity, water, waste as well as social and employee matters for corporate issuers, and, where relevant, the freedom house index is applied to investments in sovereigns. PAI indicators are considered within the Investment Manager's investment process through the means of exclusions as described in the "binding elements" section of the Sub-Fund.

The data coverage for the data required for the PAI indicators is heterogenous. The data coverage related to biodiversity, water and waste is low and the related PAI indicators are considered through exclusion of securities issued by companies having a severe violation / breach of principles and guidelines such as the Principles of the United Nations Global Compact, the OECD Guidelines for Multinational Enterprises, and the United Nations Guiding Principles for Business and Human Rights on the grounds of problematic practices around human rights, labour rights, environment, and corruption issues. Therefore, the Investment Manager will strive to increase data coverage for PAI indicators with low data coverage. The Investment Manager will regularly evaluate whether the availability of data has increased sufficiently to potentially include assessment of such data in the investment process.

Additionally, PAI indicators are, among other sustainability factors, applied to derive the SRI Rating. The SRI Rating is used for the portfolio construction.

The following PAI indicators are considered:

Applicable to corporate issuers

- GHG Emissions
- Carbon footprint
- GHG Intensity of investee companies
- Exposure to companies active in the fossil fuel sector
- Activities negatively affecting biodiversity-sensitive areas
- Emissions to water
- Hazardous waste ratio

- Violation of UN Global compact principles
- Lack of processes and compliance mechanisms to monitor compliance with UN Global Compact principles
- Board gender diversity
- Exposure to controversial weapons

Applicable to sovereign and supranational issuers

- Investee countries subject to social violations

The information on the PAI indicators will be available in the end-year report of the Sub-Fund.



What investment strategy does this financial product follow?

The investment strategy guides investment decisions based on factors such as investment objectives and risk tolerance.

Allianz Emerging Markets SRI Corporate Bond's investment objective is to invest in corporate Debt Securities of global Emerging Markets in accordance with the Sustainable and Responsible Investment Strategy (SRI Strategy).

As part of the SRI best-in-class approach, the Sub-Fund takes environmental, social, human rights, governance, and business behaviour factors into account as follows:

- The aforesaid sustainability factors are analysed through SRI Research by the Investment Manager in order to assess how sustainable development and long-term issues are taken into account in the strategy of an issuer. SRI Research means the overall process of identifying potential risks as well as potential opportunities of an investment in securities of an issuer related to the analysis of sustainability factors. SRI Research data combines external research data (which might have some limitations) with internal analyses.
- Based on a combination of the results of the external and/or internal analyses of the sustainability factors, an internal rating is derived monthly (SRI Rating) and is afterwards assigned to a corporate or sovereign issuer.

This internal SRI Rating is used to rank and select or weight securities for the portfolio construction.

The Sub-Fund's general investment approach (Sub-Fund's applicable General Asset Class Principles in combination with its individual investment restrictions) is described in the prospectus.

● What are the binding elements of the investment strategy used to select the investments to attain each of the environmental or social characteristics promoted by this financial product?

The binding elements are:

- Minimum rating coverage: At least 90% of Sub-Fund's portfolio are required to have an SRI Rating (Portfolio in this respect does not comprise non-rated derivatives and instruments that are non-rated by nature (e.g., cash and deposits)). While most holdings of Sub-Funds will have a corresponding SRI Rating some investments cannot be rated according to the SRI Research methodology. Examples of instruments not attaining to the SRI Rating include, but are not limited to cash, deposits, Target Funds and non-rated investments.
- The rated corporate instruments are adhering to the minimum rating threshold of 1,50 (out of a rating scale from 0 – 4; 0 being the worst rating and 4 the best rating).
- Reduction of investment universe by excluding at least 20% of issuers.
- Application of the following sustainable minimum exclusion criteria for direct investments:
 - securities issued by companies having a severe violation / breach of principles and guidelines such as the Principles of the United Nations Global Compact, the OECD Guidelines for Multinational Enterprises, and the United Nations Guiding Principles for Business and Human Rights on the grounds of problematic practices around human rights, labour rights, environment, and corruption issues,
 - securities issued by companies involved in controversial weapons (anti-personnel mines, cluster munitions, chemical weapons, biological weapons, depleted uranium, white phosphorus, and nuclear weapons),
 - securities issued by companies that derive more than 10% of their revenues from weapons, military equipment, and services,
 - securities issued by companies that derive more than 10% of their revenue from thermal coal extraction,

- securities issued by utility companies that generate more than 20% of their revenues from coal,
- securities issued by companies involved in the production of tobacco, and securities issued by companies involved in the distribution of tobacco with more than 5% of their revenues.

For direct investments in sovereign issuers, an internal scoring model weighting various environmental, social and governance factors is applied for which Freedom House Index is considered as one criterion amongst further criteria. Debt Securities of issuers other than sovereign issuers may not be acquired if the respective issuer's country does not meet the requirements of the aforesaid internal scoring model.

The sustainable minimum exclusion criteria are based on information from an external data provider and coded in pre- and post-trade compliance. The review is performed at least half yearly.

● **What is the committed minimum rate to reduce the scope of the investments considered prior to the application of that investment strategy?**

The Sub-Fund commits to reduce the investment universe by at least 20%.

● **What is the policy to assess good governance practices of the investee companies?**

Good governance principles are considered by screening out companies based on their involvement in controversies around international norms corresponding to the four good governance practices: sound management structures, employee relations, remuneration of staff and tax compliance. Companies having a severe violation in either of those areas will not be investible. For certain cases, flagged issuers shall be on a watch list. These companies will appear on this watch list when the Investment Manager believes that engagement may lead to improvements or when the company is assessed to take remedial actions. Companies on the watch list remain investible unless the Investment Manager believes that the engagement or the remedial actions of the company does not lead to the desired remedy of the severe controversy.

In addition, the Sub-Fund's Investment Manager is committed to actively encourage open dialogues with investee companies on corporate governance, proxy voting and broader sustainability issues in advance of shareholder meetings (regularly for direct investments in shares). The Sub-Fund's Investment Manager's approach to proxy voting and company engagement is set out in the Management Company's Stewardship Statement.

Good governance practices include sound management structures, employee relations, remuneration of staff and tax compliance.



What is the asset allocation planned for this financial product?

Asset allocation describes the share of investments in specific assets.

Min. 90% of the Sub-Funds' assets (excluding cash and non-rated derivatives) are used to meet the environmental or social characteristics promoted by this Sub-Fund. A low portion of the Sub-Fund might contain assets which do not promote environmental or social characteristics. Examples of such instruments are derivatives, cash and deposits, some Target Funds and investment with temporarily divergent or absent environmental, social, or good governance qualifications. Min. 5% of the Sub-Funds' assets will be invested in Sustainable Investments. The minimum percentage of investments that are aligned with the EU Taxonomy is 0.01%. The Sub-Fund's Investment Manager does not commit to a minimum share of environmentally Sustainable Investments that are not aligned with the EU Taxonomy. The Sub-Fund's Investment Manager does not commit to a minimum share of socially sustainable investments. While the Sub-Fund cannot commit to a minimum share of environmentally or socially sustainable investments, such investments may be freely allocated to within the Sub-Fund aggregated sustainable investment commitment disclosed (min. 5%).

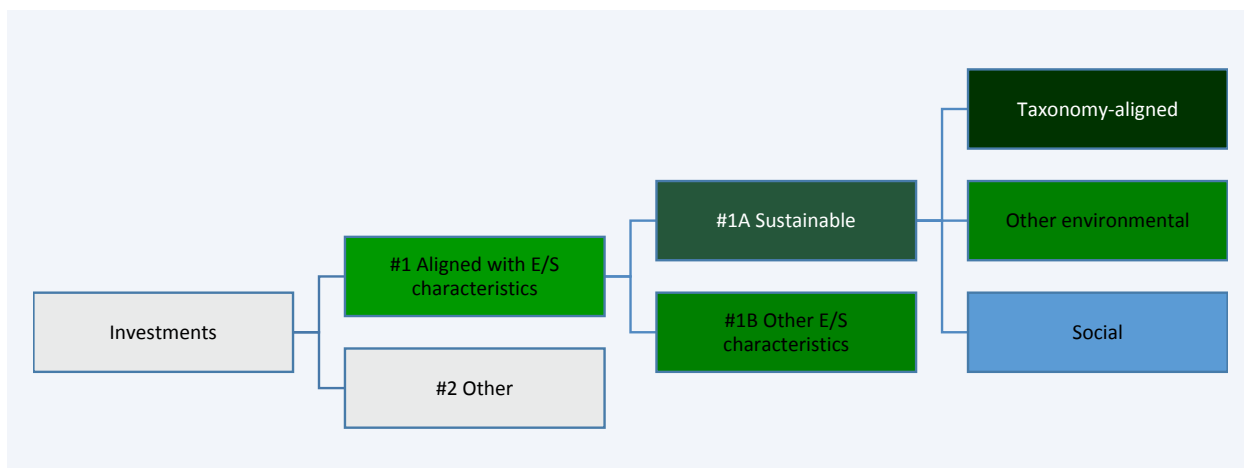

#1 Aligned with E/S characteristics includes the investments of the financial product used to attain the environmental or social characteristics promoted by the financial product.

#2 Other includes the remaining investments of the financial product which are neither aligned with the environmental or social characteristics, nor are qualified as sustainable investments.

The category **#1 Aligned with E/S characteristics** covers:

- The sub-category **#1A Sustainable** covers sustainable investments with environmental or social objectives.
- The sub-category **#1B Other E/S characteristics** covers investments aligned with the environmental or social characteristics that do not qualify as sustainable investments.

● **How does the use of derivatives attain the environmental or social characteristics promoted by the financial product?**

Not applicable



To what minimum extent are sustainable investments with an environmental objective aligned with the EU Taxonomy?

The Taxonomy-aligned investments include debt and/or equity in environmentally sustainable economic activities aligned with the EU-Taxonomy. The minimum percentage of investments that are aligned with the EU Taxonomy is 0.01%. Taxonomy-aligned data is provided by an external data provider. The Investment Manager has assessed the quality of such data. The data will not be subject to an assurance provided by auditors or a review by third parties. The data will not reflect any data in government bonds. As of today, there is no recognized methodology available to determine the proportion of Taxonomy-aligned activities when investing in government bonds.

Taxonomy-aligned activities in this disclosure are based on share of turnover. Pre-contractual figures use turnover as its financial metric as a default in line with the regulatory requirements and based on the fact that complete, verifiable or up-to date data for CAPEX and/or OPEX as financial metric is even less available.

Taxonomy-aligned data is only in rare cases data reported by companies in accordance with the EU Taxonomy. The data provider has derived Taxonomy-aligned data from other available equivalent public data.

● **Does the financial product invest in fossil gas and/or nuclear energy related activities that comply with the EU Taxonomy ¹?**

- Yes:
 - In fossil gas
 - In nuclear energy
- No

The Sub-Fund does not pursue any investments in fossil gas and/or nuclear energy related activities that comply with the EU Taxonomy. Nevertheless, as result of this investment strategy, investments may occur in corporates which are also active in these activities. Further information will be provided as part of the annual reporting, if relevant.

Taxonomy-aligned activities are expressed as a share of:

- **turnover** reflecting the share of revenue from green activities of investee companies
- **capital expenditure (CapEx)** showing the green investments made by investee companies, e.g. for a transition to a green

¹ Fossil gas and/or nuclear related activities will only comply with the EU Taxonomy where they contribute to limiting climate change ("climate change mitigation") and do not significantly harm any EU Taxonomy objective - see explanatory note in the left hand margin. The full criteria for fossil gas and nuclear energy economic activities that comply with the EU Taxonomy are laid down in Commission Delegated Regulation (EU) 2022/1214.

economy.
 - **operational expenditure (OpEx)** reflecting green operational activities of investee companies.

The two graphs below show in green the minimum percentage of investments that are aligned with the EU Taxonomy. As there is no appropriate methodology to determine the Taxonomy-alignment of sovereign bonds*, the first graph shows the Taxonomy-alignment in relation to all the investments of the financial product including sovereign bonds, while the second graph shows the Taxonomy-alignment only in relation to the investments of the financial product other than sovereign bonds.

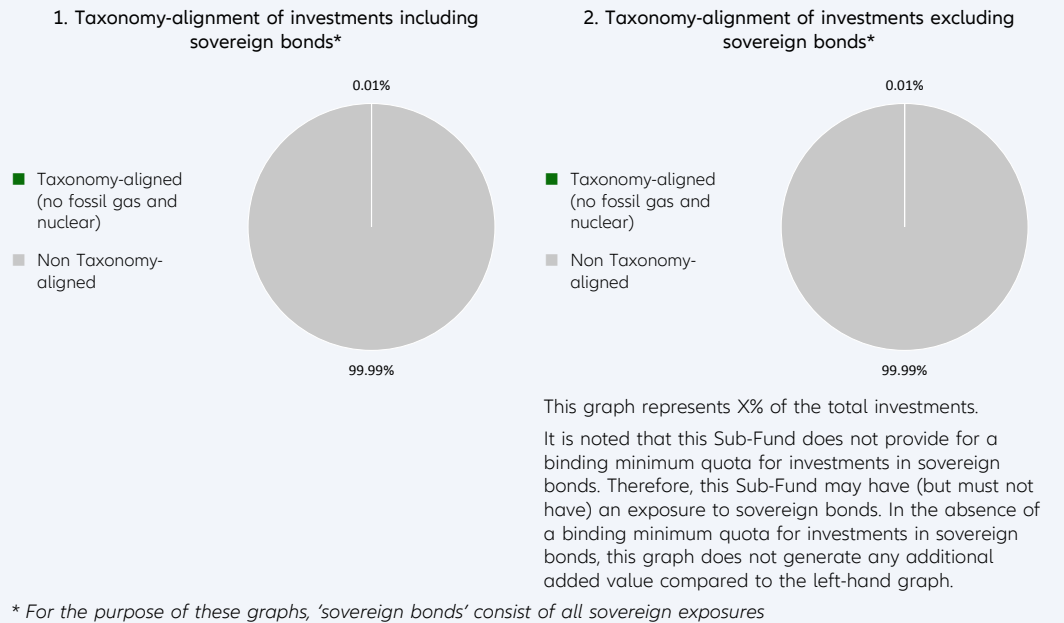

Enabling activities directly enable other activities to make a substantial contribution to an environmental objective.

Transitional activities are activities for which low-carbon alternatives are not yet available and among others have greenhouse gas emission levels corresponding to the best performance.

● **What is the minimum share of investments in transitional and enabling activities?**

The Sub-Fund's Investment Manager does not commit to a split of minimum taxonomy alignment into transitional, enabling activities and own performance.



What is the minimum share of sustainable investments with an environmental objective that are not aligned with the EU Taxonomy?

Taxonomy-aligned investments are considered a sub-category of Sustainable Investments. If an investment is not Taxonomy-aligned since the activity is not yet covered under the EU Taxonomy or the positive contribution is not substantial enough to comply with the Taxonomy technical screening criteria, the investment can still be considered an environmentally Sustainable Investment provided it complies with all criteria. The Investment Manager does not commit to a minimum share of environmentally Sustainable Investments that are not aligned with the EU Taxonomy. The overall sustainable investment share may also include investments with an environmental objective in economic activities that do not qualify as environmentally sustainable under the EU Taxonomy, and while the Sub-Fund cannot commit to a minimum share of environmentally or socially sustainable investments, such investments may be freely allocated to within the Sub-Fund aggregated sustainable investment commitment disclosed (min. 5%).

are sustainable investments with an environmental objective that **do not take into account the criteria** for environmentally sustainable economic activities under the EU Taxonomy.



What is the minimum share of socially sustainable investments?

The Investment Manager defines Sustainable Investments based on internal research, which uses, among others, the UN Sustainable Development Goals (SDGs), as well as the objectives of the EU Taxonomy as reference frameworks. The Investment Manager does not commit to a minimum share of socially Sustainable Investments, as the SDGs contain environmental as well as social objectives. The overall sustainable investment share may also include investments with a social objective, and while the Sub-Fund cannot commit to a minimum share of environmentally or socially sustainable investments, such investments may be freely allocated to within the Sub-Fund aggregated sustainable investment commitment disclosed (min. 5%).



What investments are included under “#2 Other”, what is their purpose and are there any minimum environmental or social safeguards?

Under “#2 Other” investments into cash, Target Funds, or derivatives can be included. Derivatives might be used for efficient portfolio management (including risk hedging) and/or investment purposes, and Target Funds to benefit from a specific strategy. For those investments no environmental or social safeguards are applied.



Is a specific index designated as a reference benchmark to determine whether this financial product is aligned with the environmental and/or social characteristics that it promotes?

Yes, the Sub-Fund has assigned J.P. MORGAN ESG Corporate Emerging Markets Bond (CEMBI) Broad Diversified Total Return as benchmark.

Reference benchmarks are indexes to measure whether the financial product attains the environmental or social characteristics that they promote.

- **How is the reference benchmark continuously aligned with each of the environmental or social characteristics promoted by the financial product?**

The Sub-Fund uses an ESG benchmark which is however not completely aligned with the environmental or social characteristics promoted by the sub-fund. The Benchmark applies an ESG scoring and screening methodology to tilt toward issuers ranked higher on ESG criteria and green bond, and to underweight and remove issuers that rank lower.

- **How is the alignment of the investment strategy with the methodology of the index ensured on a continuous basis?**

The benchmark is not continuously aligned as the screening and exclusion criteria of the benchmark deviate from the Sub-Fund’s investment strategy.

- **How does the designated index differ from a relevant broad market index?**

The benchmark uses ESG criteria as well as exclusion criteria for index construction.

- **Where can the methodology used for the calculation of the designated index be found?**

Details of the Benchmarks’ methodology may be found at <https://www.jpmorgan.com/insights/research/index-research/composition-docs> or at www.jpmorgan.com



Where can I find more product specific information online?

More product-specific information can be found on the website: <https://regulatory.allianzgi.com/SFDR>

Template pre-contractual disclosure for the financial products referred to in Article 8, paragraphs 1, 2 and 2a, of Regulation (EU) 2019/2088 and Article 6, first paragraph, of Regulation (EU) 2020/852

Product name:

Allianz Enhanced Short Term Euro

Legal entity identifier: 549300S8WEDESAOX7W77

Environmental and/or social characteristics

Sustainable investment means an investment in an economic activity that contributes to an environmental or social objective, provided that the investment does not significantly harm any environmental or social objective and that the investee companies follow good governance practices.

The **EU Taxonomy** is a classification system laid down in Regulation (EU) 2020/852, establishing a list of **environmentally sustainable economic activities**. That Regulation does not include a list of socially sustainable economic activities. Sustainable investments with an environmental objective might be aligned with the Taxonomy or not.

Does this financial product have a sustainable investment objective?	
<input checked="" type="radio"/> <input checked="" type="radio"/> Yes	<input checked="" type="radio"/> <input type="radio"/> No
<input type="checkbox"/> It will make a minimum of sustainable investments with an environmental objective: ___% <ul style="list-style-type: none"> <input type="checkbox"/> in economic activities that qualify as environmentally sustainable under the EU Taxonomy <input type="checkbox"/> in economic activities that do not qualify as environmentally sustainable under the EU Taxonomy 	<input checked="" type="checkbox"/> It promotes Environmental/Social (E/S) characteristics and while it does not have as its objective a sustainable investment, it will have a minimum proportion of 2.50% of sustainable investments <ul style="list-style-type: none"> <input checked="" type="checkbox"/> with an environmental objective in economic activities that qualify as environmentally sustainable under the EU Taxonomy <input checked="" type="checkbox"/> with an environmental objective in economic activities that do not qualify as environmentally sustainable under the EU Taxonomy <input checked="" type="checkbox"/> with a social objective
<input type="checkbox"/> It will make a minimum of sustainable investments with a social objective ___%	<input type="checkbox"/> It promotes E/S characteristics, but will not make any sustainable investments



What environmental and/or social characteristics are promoted by this financial product?

Allianz Enhanced Short Term Euro (the "Sub-Fund") promotes environmental, social, human rights, governance, and business behaviour factors (this domain does not apply for sovereigns issued by a Sovereign Entity) through integration of a best-in-class approach into the Sub-Fund's investment process. This encompasses the evaluation of corporate or sovereign issuers based on an SRI Rating which is used to construct the portfolio.

In addition, sustainable minimum exclusion criteria apply.

No reference benchmark has been designated for the purpose of attaining the environmental and/or social characteristics promoted by the Sub-Fund.

● What sustainability indicators are used to measure the attainment of each of the environmental or social characteristics promoted by this financial product?

To measure the attainment of the environmental and/or social characteristics the following sustainability indicators are used and reported on, at the fiscal year end:

- The actual percentage of the Sub-Fund's Portfolio (Portfolio in this respect does not comprise non-rated derivatives and instruments that are non-rated by nature (e. g., cash and deposits)) assets invested in best-in-class issuers (issuers with a minimum SRI Rating of 1 out of a scale from 0-4; 0 being the worst rating and 4 the best rating).
- Confirmation that Principal Adverse Impacts (PAIs) of investment decisions on sustainability factors are considered through the application of exclusion criteria.

Sustainability indicators measure how the environmental or social characteristics promoted by the financial product are attained.

- **What are the objectives of the sustainable investments that the financial product partially intends to make and how does the sustainable investment contribute to such objectives?**

Sustainable investments contribute to environmental and/or social objectives, for which the Investment Manager uses as reference frameworks, among others, the UN Sustainable Development Goals (SDGs), as well as the objectives of the EU Taxonomy:

1. Climate Change Mitigation
2. Climate Change Adaptation
3. Sustainable Use and Protection of Water and Marine Resources
4. Transition to a Circular Economy
5. Pollution Prevention and Control
6. Protection and Restoration of Biodiversity and Ecosystems

The assessment of the positive contribution to the environmental or social objectives is based on a proprietary framework which combines quantitative elements with qualitative inputs from internal research. The methodology applies first a quantitative breakdown of a securities issuer into its business activities. The qualitative element of the framework is an assessment if business activities contribute positively to an environmental or a social objective.

To calculate the positive contribution on the Sub-Fund level the revenue share of each issuer attributable to business activities contributing to environmental and/or social objectives is considered provided the issuer is satisfying the Do No Significant Harm (“DNSH”) and Good Governance principles, and an asset-weighted aggregation is performed as a second step. Moreover, for certain types of securities, which finance specific projects contributing to environmental or social objectives the overall investment is considered to contribute to environmental and/or social objectives, but also for these a DNSH as well as a Good Governance check for issuers is performed.

- **How do the sustainable investments that the financial product partially intends to make, not cause significant harm to any environmental or social sustainable investment objective?**

In order to ensure that Sustainable Investments do not significantly harm any other environmental and/or social objective, the Investment Manager is leveraging the PAI indicators, whereby significance thresholds have been defined to identify significantly harmful issuers. Issuers not meeting the significance threshold can be engaged for a limited time period to remediate the adverse impact. Otherwise, if the issuer does not meet the defined significance thresholds twice subsequently or in case of a failed engagement, it does not pass the DNSH assessment. Investments in securities of issuers which do not pass the DNSH assessment are not counted as sustainable investments.

- *How have the indicators for adverse impacts on sustainability factors been taken into account?*

All mandatory PAI indicators are considered either as part of the application of the exclusion criteria or through thresholds on a sectorial or absolute basis. Significance thresholds have been defined and they refer to qualitative or quantitative criteria.

Recognizing the lack of data coverage for some of the PAI indicators equivalent data points are used to assess PAI indicators when applying the DNSH assessment, when relevant, for the following indicators for corporates: share of non-renewable energy consumption and production, activities negatively affecting biodiversity-sensitive areas, emissions to water, lack of processes and compliance mechanisms to monitor compliance with UNGC principles and OECD Guidelines for Multinational Enterprises; for sovereigns: GHG Intensity and investee countries subject to social violations. In case of securities which finance specific projects contributing to environmental or social objectives equivalent data at project level might be used to ensure that Sustainable Investments do not significantly harm any other environmental and/or social objective. The Investment Manager will strive to increase data coverage for PAI indicators with low data coverage by engaging with issuers and data providers. The Investment Manager will regularly evaluate whether the availability of data has increased sufficiently to potentially include assessment of such data in the investment process.

- *How are the sustainable investments aligned with the OECD Guidelines for Multinational Enterprises and the UN Guiding Principles on Business and Human Rights? Details:*

The Investment Manager’s sustainable minimum exclusion list screens out companies based on their involvement in controversial practices against international norms. The core normative framework consists of the Principles of the UN Global Compact, the OECD Guidelines for Multinational Enterprises

Principal adverse impacts are the most significant negative impacts of investment decisions on sustainability factors relating to environmental, social and employee matters, respect for human rights, anti-corruption and anti-bribery matters.

and the UN Guiding Principles for Business and Human Rights. Securities issued by companies having a severe violation of these frameworks will be restricted from the investment universe.

The EU Taxonomy sets out a “do not significant harm” principle by which Taxonomy-aligned investments should not significantly harm EU Taxonomy objectives and is accompanied by specific EU criteria.

The “do not significant harm” principle applies only to those investments underlying the financial product that take into account the EU criteria for environmentally sustainable economic activities. The investments underlying the remaining portion of this financial product do not take into account the EU criteria for environmentally sustainable economic activities.

Any other sustainable investments must also not significantly harm any environmental or social objectives.



Does this financial product consider principal adverse impacts on sustainability factors?

Yes

No

The Management Company has joined the Net Zero Asset Manager Initiative and considers PAI indicators through stewardship including engagement, both are relevant to mitigate potential adverse impact as a company.

Due to the commitment to the Net Zero Asset Manager Initiative, the Management Company aims to reduce greenhouse gas emissions in partnership with asset owner clients on decarbonisation goals, consistent with an ambition to reach net zero emission by 2050 or sooner across all assets under management. As part of this objective the Management Company will set an interim target for the proportion of assets to be managed in line with the attainment of net zero emissions by 2050 or sooner.

The Sub-Fund’s Investment Manager considers PAI indicators regarding greenhouse gas emission, biodiversity, water, waste as well as social and employee matters for corporate issuers, and, where relevant, the freedom house index is applied to investments in sovereigns. PAI indicators are considered within the Investment Manager’s investment process through the means of exclusions as described in the “binding elements” section of the Sub-Fund.

The data coverage for the data required for the PAI indicators is heterogenous. The data coverage related to biodiversity, water and waste is low and the related PAI indicators are considered through exclusion of securities issued by companies having a severe violation / breach of principles and guidelines such as the Principles of the United Nations Global Compact, the OECD Guidelines for Multinational Enterprises, and the United Nations Guiding Principles for Business and Human Rights on the grounds of problematic practices around human rights, labour rights, environment, and corruption issues. Therefore, the Investment Manager will strive to increase data coverage for PAI indicators with low data coverage. The Investment Manager will regularly evaluate whether the availability of data has increased sufficiently to potentially include assessment of such data in the investment process.

Additionally, PAI indicators are, among other sustainability factors, applied to derive the SRI Rating. The SRI Rating is used for the portfolio construction.

The following PAI indicators are considered:

Applicable to corporate issuers

- GHG Emissions
- Carbon footprint
- GHG Intensity of investee companies
- Exposure to companies active in the fossil fuel sector
- Activities negatively affecting biodiversity-sensitive areas
- Emissions to water
- Hazardous waste ratio
- Violation of UN Global compact principles
- Lack of processes and compliance mechanisms to monitor compliance with UN Global Compact principles
- Board gender diversity
- Exposure to controversial weapons

Applicable to sovereign and supranational issuers

- Investee countries subject to social violations

The information on the PAI indicators will be available in the end-year report of the Sub-Fund.



The investment strategy guides investment decisions based on factors such as investment objectives and risk tolerance.

What investment strategy does this financial product follow?

Allianz Enhanced Short Term Euro's investment objective is to invest in global Bond Markets with Euro exposure in accordance with the Sustainable and Responsible Investment Strategy (SRI Strategy). With the objective of achieving additional returns, the Investment Manager may also assume separate risks related to bonds and money market instruments and may engage in foreign currency overlay and thus may also assume separate currency risks, even if the Sub-Fund does not include any assets denominated in these respective currencies.

As part of the SRI best-in-class approach, the Sub-Fund takes environmental, social, human rights, governance, and business behaviour factors into account as follows:

- The aforesaid sustainability factors are analysed through SRI Research by the Investment Manager in order to assess how sustainable development and long-term issues are taken into account in the strategy of an issuer. SRI Research means the overall process of identifying potential risks as well as potential opportunities of an investment in securities of an issuer related to the analysis of sustainability factors. SRI Research data combines external research data (which might have some limitations) with internal analyses.
- Based on a combination of the results of the external and/or internal analyses of the sustainability factors, an internal rating is derived monthly (SRI Rating) and is afterwards assigned to a corporate or sovereign issuer.

This internal SRI Rating is used to rank and select or weight securities for the portfolio construction.

The Sub-Fund's general investment approach (Sub-Fund's applicable General Asset Class Principles in combination with its individual investment restrictions) is described in the prospectus.

● What are the binding elements of the investment strategy used to select the investments to attain each of the environmental or social characteristics promoted by this financial product?

The binding elements are:

- Minimum rating coverage: At least 70% of the Sub-Fund's portfolio is required to have an SRI Rating (portfolio in this respect does not comprise non-rated derivatives and instruments that are non-rated by nature e.g., cash and deposits). While most holdings of the Sub-Fund will have a corresponding SRI Rating some investments cannot be rated according to the SRI Research methodology. Examples of instruments not attaining to the SRI Rating include, but are not limited to cash, deposits, Target Funds, and non-rated investments.
- The rated instruments are adhering to the minimum rating threshold of 1 (out of a rating scale from 0 – 4; 0 being the worst rating and 4 the best rating).
- Application of the following sustainable minimum exclusion criteria for direct investments:
 - securities issued by companies having a severe violation / breach of principles and guidelines such as the Principles of the United Nations Global Compact, the OECD Guidelines for Multinational Enterprises, and the United Nations Guiding Principles for Business and Human Rights on the grounds of problematic practices around human rights, labour rights, environment, and corruption issues,
 - securities issued by companies involved in controversial weapons (anti-personnel mines, cluster munitions, chemical weapons, biological weapons, depleted uranium, white phosphorus, and nuclear weapons),
 - securities issued by companies that derive more than 10% of their revenues from weapons, military equipment, and services,
 - securities issued by companies that derive more than 10% of their revenue from thermal coal extraction,
 - securities issued by utility companies that generate more than 20% of their revenues from coal,
 - securities issued by companies involved in the production of tobacco, and securities issued by companies involved in the distribution of tobacco with more than 5% of their revenues.

Direct investments in sovereign issuers with an insufficient freedom house index score are excluded.

The sustainable minimum exclusion criteria are based on information from an external data provider and coded in pre- and post-trade compliance. The review is performed at least half yearly.

- **What is the committed minimum rate to reduce the scope of the investments considered prior to the application of that investment strategy?**

The Sub-Fund does not commit to reduce the scope of the investments by a certain minimum rate.

- **What is the policy to assess good governance practices of the investee companies?**

Good governance principles are considered by screening out companies based on their involvement in controversies around international norms corresponding to the four good governance practices: sound management structures, employee relations, remuneration of staff and tax compliance. Companies having a severe violation in either of those areas will not be investible. For certain cases, flagged issuers shall be on a watch list. These companies will appear on this watch list when the Investment Manager believes that engagement may lead to improvements or when the company is assessed to take remedial actions. Companies on the watch list remain investible unless the Investment Manager believes that the engagement or the remedial actions of the company does not lead to the desired remedy of the severe controversy.

In addition, the Sub-Fund’s Investment Manager is committed to actively encourage open dialogues with investee companies on corporate governance, proxy voting and broader sustainability issues in advance of shareholder meetings (regularly for direct investments in shares). The Sub-Fund’s Investment Manager’s approach to proxy voting and company engagement is set out in the Management Company’s Stewardship Statement.

Good governance practices include sound management structures, employee relations, remuneration of staff and tax compliance.



What is the asset allocation planned for this financial product?

Asset allocation describes the share of investments in specific assets.

Min. 70% of the Sub-Funds’ assets (excluding cash and non-rated derivatives) are used to meet the environmental or social characteristics promoted by this Sub-Fund. A low portion of the Sub-Fund might contain assets which do not promote environmental or social characteristics. Examples of such instruments are derivatives, cash and deposits, some Target Funds and investment with temporarily divergent or absent environmental, social, or good governance qualifications. Min. 2.50% of the Sub-Funds' assets will be invested in Sustainable Investments. The minimum percentage of investments that are aligned with the EU Taxonomy is 0.01%. The Sub-Fund’s Investment Manager does not commit to a minimum share of environmentally Sustainable Investments that are not aligned with the EU Taxonomy. The Sub-Fund’s Investment Manager does not commit to a minimum share of socially sustainable investments. While the Sub-Fund cannot commit to a minimum share of environmentally or socially sustainable investments, such investments may be freely allocated to within the Sub-Fund aggregated sustainable investment commitment disclosed (min. 2,50%).

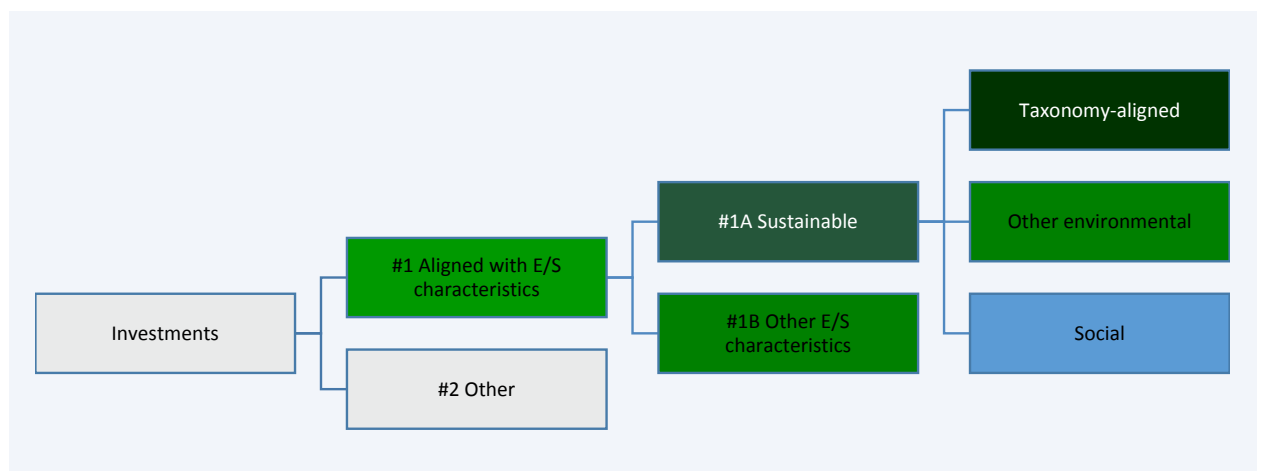

#1 Aligned with E/S characteristics includes the investments of the financial product used to attain the environmental or social characteristics promoted by the financial product.

#2 Other includes the remaining investments of the financial product which are neither aligned with the environmental or social characteristics, nor are qualified as sustainable investments.

The category **#1 Aligned with E/S characteristics** covers:

- The sub-category **#1A Sustainable** covers sustainable investments with environmental or social objectives.
- The sub-category **#1B Other E/S characteristics** covers investments aligned with the environmental or social characteristics that do not qualify as sustainable investments.

- **How does the use of derivatives attain the environmental or social characteristics promoted by the financial product?**

Not applicable



To what minimum extent are sustainable investments with an environmental objective aligned with the EU Taxonomy?

The Taxonomy-aligned investments include debt and/or equity in environmentally sustainable economic activities aligned with the EU-Taxonomy. The minimum percentage of investments that are aligned with the EU Taxonomy is 0.01%. Taxonomy-aligned data is provided by an external data provider. The Investment Manager has assessed the quality of such data. The data will not be subject to an assurance provided by auditors or a review by third parties. The data will not reflect any data in government bonds. As of today, there is no recognized methodology available to determine the proportion of Taxonomy-aligned activities when investing in government bonds.

Taxonomy-aligned activities in this disclosure are based on share of turnover. Pre-contractual figures use turnover as its financial metric as a default in line with the regulatory requirements and based on the fact that complete, verifiable or up-to date data for CAPEX and/or OPEX as financial metric is even less available.

Taxonomy-aligned data is only in rare cases data reported by companies in accordance with the EU Taxonomy. The data provider has derived Taxonomy-aligned data from other available equivalent public data.

- **Does the financial product invest in fossil gas and/or nuclear energy related activities that comply with the EU Taxonomy ¹?**

- Yes:
 - In fossil gas
 - In nuclear energy
- No

The Sub-Fund does not pursue any investments in fossil gas and/or nuclear energy related activities that comply with the EU Taxonomy. Nevertheless, as result of this investment strategy, investments may occur in corporates which are also active in these activities. Further information will be provided as part of the annual reporting, if relevant.

The two graphs below show in green the minimum percentage of investments that are aligned with the EU Taxonomy. As there is no appropriate methodology to determine the Taxonomy-alignment of sovereign bonds, the first graph shows the Taxonomy-alignment in relation to all the investments of the financial product including sovereign bonds, while the second graph shows the Taxonomy-alignment only in relation to the investments of the financial product other than sovereign bonds.*

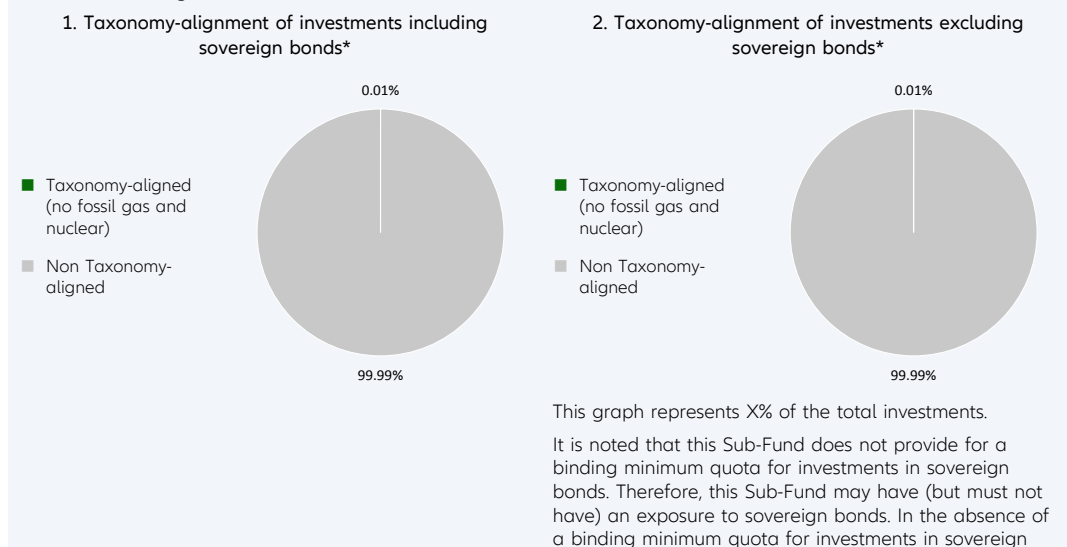

Taxonomy-aligned activities are expressed as a share of:

- **turnover** reflecting the share of revenue from green activities of investee companies
- **capital expenditure (CapEx)** showing the green investments made by investee companies, e.g. for a transition to a green economy.
- **operational expenditure (OpEx)** reflecting green operational activities of investee companies.

¹ Fossil gas and/or nuclear related activities will only comply with the EU Taxonomy where they contribute to limiting climate change ("climate change mitigation") and do not significantly harm any EU Taxonomy objective - see explanatory note in the left hand margin. The full criteria for fossil gas and nuclear energy economic activities that comply with the EU Taxonomy are laid down in Commission Delegated Regulation (EU) 2022/1214.

bonds, this graph does not generate any additional added value compared to the left-hand graph.

* For the purpose of these graphs, 'sovereign bonds' consist of all sovereign exposures

Enabling activities directly enable other activities to make a substantial contribution to an environmental objective.

Transitional activities are activities for which low-carbon alternatives are not yet available and among others have greenhouse gas emission levels corresponding to the best performance.

● What is the minimum share of investments in transitional and enabling activities?

The Sub-Fund's Investment Manager does not commit to a split of minimum taxonomy alignment into transitional, enabling activities and own performance.



What is the minimum share of sustainable investments with an environmental objective that are not aligned with the EU Taxonomy?

Taxonomy-aligned investments are considered a sub-category of Sustainable Investments. If an investment is not Taxonomy-aligned since the activity is not yet covered under the EU Taxonomy or the positive contribution is not substantial enough to comply with the Taxonomy technical screening criteria, the investment can still be considered an environmentally Sustainable Investment provided it complies with all criteria. The Investment Manager does not commit to a minimum share of environmentally Sustainable Investments that are not aligned with the EU Taxonomy. The overall sustainable investment share may also include investments with an environmental objective in economic activities that do not qualify as environmentally sustainable under the EU Taxonomy, and while the Sub-Fund cannot commit to a minimum share of environmentally or socially sustainable investments, such investments may be freely allocated to within the Sub-Fund aggregated sustainable investment commitment disclosed (min. 2,50%).



are sustainable investments with an environmental objective that **do not take into account the criteria** for environmentally sustainable economic activities under the EU Taxonomy.



What is the minimum share of socially sustainable investments?

The Investment Manager defines Sustainable Investments based on internal research, which uses, among others, the UN Sustainable Development Goals (SDGs), as well as the objectives of the EU Taxonomy as reference frameworks. The Investment Manager does not commit to a minimum share of socially Sustainable Investments, as the SDGs contain environmental as well as social objectives. The overall sustainable investment share may also include investments with a social objective, and while the Sub-Fund cannot commit to a minimum share of environmentally or socially sustainable investments, such investments may be freely allocated to within the Sub-Fund aggregated sustainable investment commitment disclosed (min. 2,50%).



What investments are included under “#2 Other”, what is their purpose and are there any minimum environmental or social safeguards?

Under “#2 Other” investments into cash, Target Funds, or derivatives can be included. Derivatives might be used for efficient portfolio management (including risk hedging) and/or investment purposes, and Target Funds to benefit from a specific strategy. For those investments no environmental or social safeguards are applied.



Is a specific index designated as a reference benchmark to determine whether this financial product is aligned with the environmental and/or social characteristics that it promotes?

No reference benchmark has been designated for the purpose of attaining the environmental and/or social characteristics promoted by the Sub-Fund.

Reference benchmarks are indexes to measure whether the financial product attains the environmental or social characteristics that they promote.

- **How is the reference benchmark continuously aligned with each of the environmental or social characteristics promoted by the financial product?**
Not applicable
- **How is the alignment of the investment strategy with the methodology of the index ensured on a continuous basis?**
Not applicable
- **How does the designated index differ from a relevant broad market index?**
Not applicable
- **Where can the methodology used for the calculation of the designated index be found?**
Not applicable



Where can I find more product specific information online?

More product-specific information can be found on the website: <https://regulatory.allianzgi.com/SFDR>

Template pre-contractual disclosure for the financial products referred to in Article 8, paragraphs 1, 2 and 2a, of Regulation (EU) 2019/2088 and Article 6, first paragraph, of Regulation (EU) 2020/852

Product name:

Allianz Euro Balanced

Legal entity identifier: 529900R48QOZDVDDMW24

Environmental and/or social characteristics

Sustainable investment means an investment in an economic activity that contributes to an environmental or social objective, provided that the investment does not significantly harm any environmental or social objective and that the investee companies follow good governance practices.

The **EU Taxonomy** is a classification system laid down in Regulation (EU) 2020/852, establishing a list of **environmentally sustainable economic activities**. That Regulation does not include a list of socially sustainable economic activities. Sustainable investments with an environmental objective might be aligned with the Taxonomy or not.

Does this financial product have a sustainable investment objective?	
<input checked="" type="radio"/> <input checked="" type="radio"/> Yes	<input checked="" type="radio"/> <input type="radio"/> No
<input type="checkbox"/> It will make a minimum of sustainable investments with an environmental objective: ___% <ul style="list-style-type: none"> <input type="checkbox"/> in economic activities that qualify as environmentally sustainable under the EU Taxonomy <input type="checkbox"/> in economic activities that do not qualify as environmentally sustainable under the EU Taxonomy 	<input checked="" type="checkbox"/> It promotes Environmental/Social (E/S) characteristics and while it does not have as its objective a sustainable investment, it will have a minimum proportion of 7.50% of sustainable investments <ul style="list-style-type: none"> <input checked="" type="checkbox"/> with an environmental objective in economic activities that qualify as environmentally sustainable under the EU Taxonomy <input checked="" type="checkbox"/> with an environmental objective in economic activities that do not qualify as environmentally sustainable under the EU Taxonomy <input checked="" type="checkbox"/> with a social objective
<input type="checkbox"/> It will make a minimum of sustainable investments with a social objective ___%	<input type="checkbox"/> It promotes E/S characteristics, but will not make any sustainable investments



What environmental and/or social characteristics are promoted by this financial product?

Allianz Euro Balanced (the "Sub-Fund") promotes environmental, social, human rights, governance, and business behaviour factors (this domain does not apply for sovereigns issued by a Sovereign Entity) through integration of a best-in-class approach into the Sub-Fund's investment process. This encompasses the evaluation of corporate or sovereign issuers based on an SRI Rating which is used to construct the portfolio.

In addition, sustainable minimum exclusion criteria apply.

No reference benchmark has been designated for the purpose of attaining the environmental and/or social characteristics promoted by the Sub-Fund.

What sustainability indicators are used to measure the attainment of each of the environmental or social characteristics promoted by this financial product?

To measure the attainment of the environmental and/or social characteristics the following sustainability indicators are used and reported on, at the fiscal year end:

- The actual percentage of the Sub-Fund's Portfolio (Portfolio in this respect does not comprise non-rated derivatives and instruments that are non-rated by nature (e. g., cash and deposits)) assets invested in best-in-class issuers (issuers with a minimum SRI Rating of 1 out of a scale from 0-4; 0 being the worst rating and 4 the best rating) is compared to the actual percentage of the benchmarks best-in-class issuers.
- Confirmation that Principal Adverse Impacts (PAIs) of investment decisions on sustainability factors are considered through the application of exclusion criteria.

Sustainability indicators measure how the environmental or social characteristics promoted by the financial product are attained.

- **What are the objectives of the sustainable investments that the financial product partially intends to make and how does the sustainable investment contribute to such objectives?**

Sustainable investments contribute to environmental and/or social objectives, for which the Investment Manager uses as reference frameworks, among others, the UN Sustainable Development Goals (SDGs), as well as the objectives of the EU Taxonomy:

1. Climate Change Mitigation
2. Climate Change Adaptation
3. Sustainable Use and Protection of Water and Marine Resources
4. Transition to a Circular Economy
5. Pollution Prevention and Control
6. Protection and Restoration of Biodiversity and Ecosystems

The assessment of the positive contribution to the environmental or social objectives is based on a proprietary framework which combines quantitative elements with qualitative inputs from internal research. The methodology applies first a quantitative breakdown of a securities issuer into its business activities. The qualitative element of the framework is an assessment if business activities contribute positively to an environmental or a social objective.

To calculate the positive contribution on the Sub-Fund level the revenue share of each issuer attributable to business activities contributing to environmental and/or social objectives is considered provided the issuer is satisfying the Do No Significant Harm (“DNSH”) and Good Governance principles, and an asset-weighted aggregation is performed as a second step. Moreover, for certain types of securities, which finance specific projects contributing to environmental or social objectives the overall investment is considered to contribute to environmental and/or social objectives, but also for these a DNSH as well as a Good Governance check for issuers is performed.

- **How do the sustainable investments that the financial product partially intends to make, not cause significant harm to any environmental or social sustainable investment objective?**

In order to ensure that Sustainable Investments do not significantly harm any other environmental and/or social objective, the Investment Manager is leveraging the PAI indicators, whereby significance thresholds have been defined to identify significantly harmful issuers. Issuers not meeting the significance threshold can be engaged for a limited time period to remediate the adverse impact. Otherwise, if the issuer does not meet the defined significance thresholds twice subsequently or in case of a failed engagement, it does not pass the DNSH assessment. Investments in securities of issuers which do not pass the DNSH assessment are not counted as sustainable investments.

- *How have the indicators for adverse impacts on sustainability factors been taken into account?*

All mandatory PAI indicators are considered either as part of the application of the exclusion criteria or through thresholds on a sectorial or absolute basis. Significance thresholds have been defined and they refer to qualitative or quantitative criteria.

Recognizing the lack of data coverage for some of the PAI indicators equivalent data points are used to assess PAI indicators when applying the DNSH assessment, when relevant, for the following indicators for corporates: share of non-renewable energy consumption and production, activities negatively affecting biodiversity-sensitive areas, emissions to water, lack of processes and compliance mechanisms to monitor compliance with UNGC principles and OECD Guidelines for Multinational Enterprises; for sovereigns: GHG Intensity and investee countries subject to social violations. In case of securities which finance specific projects contributing to environmental or social objectives equivalent data at project level might be used to ensure that Sustainable Investments do not significantly harm any other environmental and/or social objective. The Investment Manager will strive to increase data coverage for PAI indicators with low data coverage by engaging with issuers and data providers. The Investment Manager will regularly evaluate whether the availability of data has increased sufficiently to potentially include assessment of such data in the investment process.

- *How are the sustainable investments aligned with the OECD Guidelines for Multinational Enterprises and the UN Guiding Principles on Business and Human Rights? Details:*

The Investment Manager’s sustainable minimum exclusion list screens out companies based on their involvement in controversial practices against international norms. The core normative framework consists of the Principles of the UN Global Compact, the OECD Guidelines for Multinational Enterprises

Principal adverse impacts are the most significant negative impacts of investment decisions on sustainability factors relating to environmental, social and employee matters, respect for human rights, anti-corruption and anti-bribery matters.

and the UN Guiding Principles for Business and Human Rights. Securities issued by companies having a severe violation of these frameworks will be restricted from the investment universe.

The EU Taxonomy sets out a “do not significant harm” principle by which Taxonomy-aligned investments should not significantly harm EU Taxonomy objectives and is accompanied by specific EU criteria.

The “do not significant harm” principle applies only to those investments underlying the financial product that take into account the EU criteria for environmentally sustainable economic activities. The investments underlying the remaining portion of this financial product do not take into account the EU criteria for environmentally sustainable economic activities.

Any other sustainable investments must also not significantly harm any environmental or social objectives.



Does this financial product consider principal adverse impacts on sustainability factors?

Yes

No

The Management Company has joined the Net Zero Asset Manager Initiative and considers PAI indicators through stewardship including engagement, both are relevant to mitigate potential adverse impact as a company.

Due to the commitment to the Net Zero Asset Manager Initiative, the Management Company aims to reduce greenhouse gas emissions in partnership with asset owner clients on decarbonisation goals, consistent with an ambition to reach net zero emission by 2050 or sooner across all assets under management. As part of this objective the Management Company will set an interim target for the proportion of assets to be managed in line with the attainment of net zero emissions by 2050 or sooner.

The Sub-Fund’s Investment Manager considers PAI indicators regarding greenhouse gas emission, biodiversity, water, waste as well as social and employee matters for corporate issuers, and, where relevant, the freedom house index is applied to investments in sovereigns. PAI indicators are considered within the Investment Manager’s investment process through the means of exclusions as described in the “binding elements” section of the Sub-Fund.

The data coverage for the data required for the PAI indicators is heterogenous. The data coverage related to biodiversity, water and waste is low and the related PAI indicators are considered through exclusion of securities issued by companies having a severe violation / breach of principles and guidelines such as the Principles of the United Nations Global Compact, the OECD Guidelines for Multinational Enterprises, and the United Nations Guiding Principles for Business and Human Rights on the grounds of problematic practices around human rights, labour rights, environment, and corruption issues. Therefore, the Investment Manager will strive to increase data coverage for PAI indicators with low data coverage. The Investment Manager will regularly evaluate whether the availability of data has increased sufficiently to potentially include assessment of such data in the investment process.

Additionally, PAI indicators are, among other sustainability factors, applied to derive the SRI Rating. The SRI Rating is used for the portfolio construction.

The following PAI indicators are considered:

Applicable to corporate issuers

- GHG Emissions
- Carbon footprint
- GHG Intensity of investee companies
- Exposure to companies active in the fossil fuel sector
- Activities negatively affecting biodiversity-sensitive areas
- Emissions to water
- Hazardous waste ratio
- Violation of UN Global compact principles
- Lack of processes and compliance mechanisms to monitor compliance with UN Global Compact principles
- Board gender diversity
- Exposure to controversial weapons

Applicable to sovereign and supranational issuers

- Investee countries subject to social violations

The information on the PAI indicators will be available in the end-year report of the Sub-Fund.



The investment strategy guides investment decisions based on factors such as investment objectives and risk tolerance.

What investment strategy does this financial product follow?

Allianz Euro Balanced's investment objective is to invest in Eurozone Equity Markets and Eurozone Government Bond Markets in accordance with the Sustainable and Responsible Investment Strategy (SRI Strategy).

As part of the SRI best-in-class approach, the Sub-Fund takes environmental, social, human rights, governance, and business behaviour factors into account as follows:

- The aforesaid sustainability factors are analysed through SRI Research by the Investment Manager in order to assess how sustainable development and long-term issues are taken into account in the strategy of an issuer. SRI Research means the overall process of identifying potential risks as well as potential opportunities of an investment in securities of an issuer related to the analysis of sustainability factors. SRI Research data combines external research data (which might have some limitations) with internal analyses.
- Based on a combination of the results of the external and/or internal analyses of the sustainability factors, an internal rating is derived monthly (SRI Rating) and is afterwards assigned to a corporate or sovereign issuer.

This internal SRI Rating is used to rank and select or weight securities for the portfolio construction.

The Sub-Fund's general investment approach (Sub-Fund's applicable General Asset Class Principles in combination with its individual investment restrictions) is described in the prospectus.

● What are the binding elements of the investment strategy used to select the investments to attain each of the environmental or social characteristics promoted by this financial product?

The binding elements are:

- Minimum rating coverage: At least 90% of the Sub-Fund's portfolio is required to have an SRI Rating (portfolio in this respect does not comprise non-rated derivatives and instruments that are non-rated by nature e.g., cash and deposits). While most holdings of the Sub-Fund will have a corresponding SRI Rating some investments cannot be rated according to the SRI Research methodology. Examples of instruments not attaining to the SRI Rating include, but are not limited to cash, deposits, Target Funds, and non-rated investments.
- 80% of the rated instruments are adhering to the minimum rating threshold of 1 (out of a rating scale from 0 – 4; 0 being the worst rating and 4 the best rating) for equities, and 100% for debt securities.
- Application of the following sustainable minimum exclusion criteria for direct investments:
 - securities issued by companies having a severe violation / breach of principles and guidelines such as the Principles of the United Nations Global Compact, the OECD Guidelines for Multinational Enterprises, and the United Nations Guiding Principles for Business and Human Rights on the grounds of problematic practices around human rights, labour rights, environment, and corruption issues,
 - securities issued by companies involved in controversial weapons (anti-personnel mines, cluster munitions, chemical weapons, biological weapons, depleted uranium, white phosphorus, and nuclear weapons),
 - securities issued by companies that derive more than 10% of their revenues from weapons, military equipment, and services,
 - securities issued by companies that derive more than 10% of their revenue from thermal coal extraction,
 - securities issued by utility companies that generate more than 20% of their revenues from coal,
 - securities issued by companies involved in the production of tobacco, and securities issued by companies involved in the distribution of tobacco with more than 5% of their revenues.

Direct investments in sovereign issuers with an insufficient freedom house index score are excluded.

The sustainable minimum exclusion criteria are based on information from an external data provider and coded in pre- and post-trade compliance. The review is performed at least half yearly.

- **What is the committed minimum rate to reduce the scope of the investments considered prior to the application of that investment strategy?**

The Sub-Fund does not commit to reduce the scope of the investments by a certain minimum rate.

- **What is the policy to assess good governance practices of the investee companies?**

Good governance principles are considered by screening out companies based on their involvement in controversies around international norms corresponding to the four good governance practices: sound management structures, employee relations, remuneration of staff and tax compliance. Companies having a severe violation in either of those areas will not be investible. For certain cases, flagged issuers shall be on a watch list. These companies will appear on this watch list when the Investment Manager believes that engagement may lead to improvements or when the company is assessed to take remedial actions. Companies on the watch list remain investible unless the Investment Manager believes that the engagement or the remedial actions of the company does not lead to the desired remedy of the severe controversy.

In addition, the Sub-Fund’s Investment Manager is committed to actively encourage open dialogues with investee companies on corporate governance, proxy voting and broader sustainability issues in advance of shareholder meetings (regularly for direct investments in shares). The Sub-Fund’s Investment Manager’s approach to proxy voting and company engagement is set out in the Management Company’s Stewardship Statement.

Good governance practices include sound management structures, employee relations, remuneration of staff and tax compliance.



What is the asset allocation planned for this financial product?

Asset allocation describes the share of investments in specific assets.

Min. 90% of the Sub-Funds’ assets (excluding cash and non-rated derivatives) are used to meet the environmental or social characteristics promoted by this Sub-Fund. A low portion of the Sub-Fund might contain assets which do not promote environmental or social characteristics. Examples of such instruments are derivatives, cash and deposits, some Target Funds and investment with temporarily divergent or absent environmental, social, or good governance qualifications. Min. 7.50% of the Sub-Funds' assets will be invested in Sustainable Investments. The minimum percentage of investments that are aligned with the EU Taxonomy is 0.01%. The Sub-Fund’s Investment Manager does not commit to a minimum share of environmentally Sustainable Investments that are not aligned with the EU Taxonomy. The Sub-Fund’s Investment Manager does not commit to a minimum share of socially sustainable investments. While the Sub-Fund cannot commit to a minimum share of environmentally or socially sustainable investments, such investments may be freely allocated to within the Sub-Fund aggregated sustainable investment commitment disclosed (min. 7,50%).

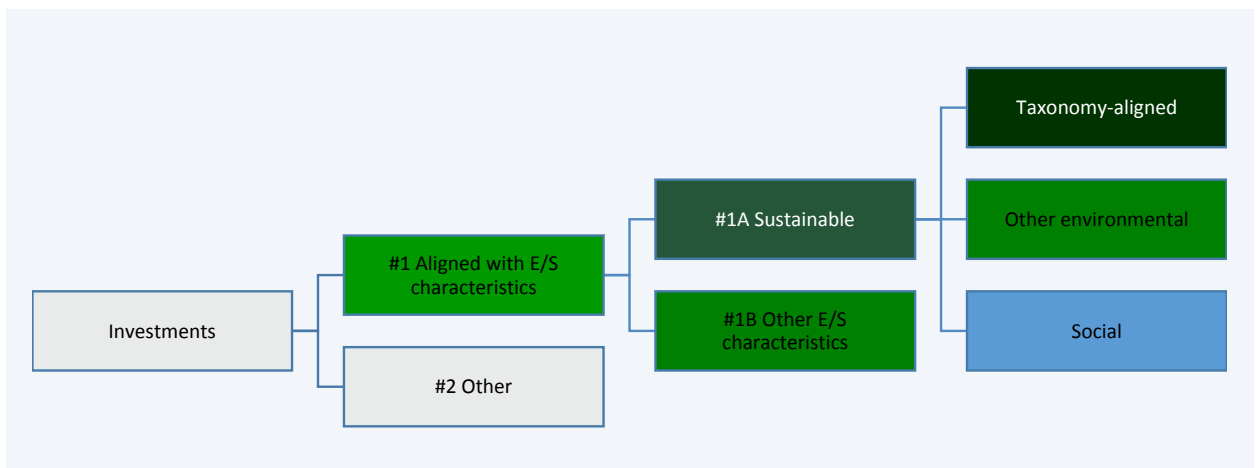

#1 Aligned with E/S characteristics includes the investments of the financial product used to attain the environmental or social characteristics promoted by the financial product.

#2 Other includes the remaining investments of the financial product which are neither aligned with the environmental or social characteristics, nor are qualified as sustainable investments.

The category **#1 Aligned with E/S characteristics** covers:

- The sub-category **#1A Sustainable** covers sustainable investments with environmental or social objectives.
- The sub-category **#1B Other E/S characteristics** covers investments aligned with the environmental or social characteristics that do not qualify as sustainable investments.

- How does the use of derivatives attain the environmental or social characteristics promoted by the financial product?

Not applicable



To what minimum extent are sustainable investments with an environmental objective aligned with the EU Taxonomy?

The Taxonomy-aligned investments include debt and/or equity in environmentally sustainable economic activities aligned with the EU-Taxonomy. The minimum percentage of investments that are aligned with the EU Taxonomy is 0.01%. Taxonomy-aligned data is provided by an external data provider. The Investment Manager has assessed the quality of such data. The data will not be subject to an assurance provided by auditors or a review by third parties. The data will not reflect any data in government bonds. As of today, there is no recognized methodology available to determine the proportion of Taxonomy-aligned activities when investing in government bonds.

Taxonomy-aligned activities in this disclosure are based on share of turnover. Pre-contractual figures use turnover as its financial metric as a default in line with the regulatory requirements and based on the fact that complete, verifiable or up-to date data for CAPEX and/or OPEX as financial metric is even less available.

Taxonomy-aligned data is only in rare cases data reported by companies in accordance with the EU Taxonomy. The data provider has derived Taxonomy-aligned data from other available equivalent public data.

- Does the financial product invest in fossil gas and/or nuclear energy related activities that comply with the EU Taxonomy ¹?

Yes:

In fossil gas In nuclear energy

No

The Sub-Fund does not pursue any investments in fossil gas and/or nuclear energy related activities that comply with the EU Taxonomy. Nevertheless, as result of this investment strategy, investments may occur in corporates which are also active in these activities. Further information will be provided as part of the annual reporting, if relevant.

The two graphs below show in green the minimum percentage of investments that are aligned with the EU Taxonomy. As there is no appropriate methodology to determine the Taxonomy-alignment of sovereign bonds*, the first graph shows the Taxonomy-alignment in relation to all the investments of the financial product including sovereign bonds, while the second graph shows the Taxonomy-alignment only in relation to the investments of the financial product other than sovereign bonds.

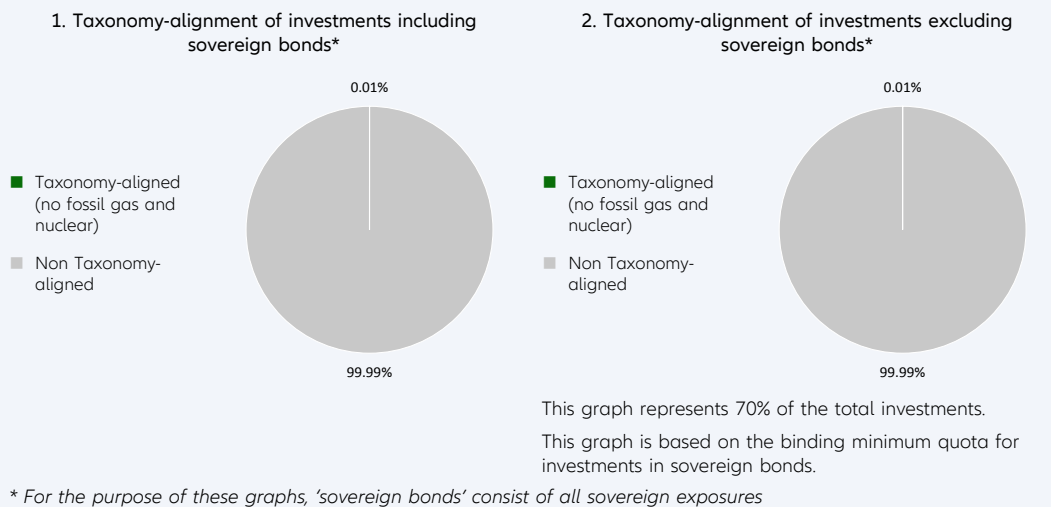

¹ Fossil gas and/or nuclear related activities will only comply with the EU Taxonomy where they contribute to limiting climate change ("climate change mitigation") and do not significantly harm any EU Taxonomy objective - see explanatory note in the left hand margin. The full criteria for fossil gas and nuclear energy economic activities that comply with the EU Taxonomy are laid down in Commission Delegated Regulation (EU) 2022/1214.

Enabling activities directly enable other activities to make a substantial contribution to an environmental objective.

Transitional activities are activities for which low-carbon alternatives are not yet available and among others have greenhouse gas emission levels corresponding to the best performance.

- **What is the minimum share of investments in transitional and enabling activities?**

The Sub-Fund's Investment Manager does not commit to a split of minimum taxonomy alignment into transitional, enabling activities and own performance.



- **What is the minimum share of sustainable investments with an environmental objective that are not aligned with the EU Taxonomy?**

Taxonomy-aligned investments are considered a sub-category of Sustainable Investments. If an investment is not Taxonomy-aligned since the activity is not yet covered under the EU Taxonomy or the positive contribution is not substantial enough to comply with the Taxonomy technical screening criteria, the investment can still be considered an environmentally Sustainable Investment provided it complies with all criteria. The Investment Manager does not commit to a minimum share of environmentally Sustainable Investments that are not aligned with the EU Taxonomy. The overall sustainable investment share may also include investments with an environmental objective in economic activities that do not qualify as environmentally sustainable under the EU Taxonomy, and while the Sub-Fund cannot commit to a minimum share of environmentally or socially sustainable investments, such investments may be freely allocated to within the Sub-Fund aggregated sustainable investment commitment disclosed (min. 7,50%).



are sustainable investments with an environmental objective that **do not take into account the criteria** for environmentally sustainable economic activities under the EU Taxonomy.



- **What is the minimum share of socially sustainable investments?**

The Investment Manager defines Sustainable Investments based on internal research, which uses, among others, the UN Sustainable Development Goals (SDGs), as well as the objectives of the EU Taxonomy as reference frameworks. The Investment Manager does not commit to a minimum share of socially Sustainable Investments, as the SDGs contain environmental as well as social objectives. The overall sustainable investment share may also include investments with a social objective, and while the Sub-Fund cannot commit to a minimum share of environmentally or socially sustainable investments, such investments may be freely allocated to within the Sub-Fund aggregated sustainable investment commitment disclosed (min. 7,50%).



- **What investments are included under “#2 Other”, what is their purpose and are there any minimum environmental or social safeguards?**

Under “#2 Other” investments into cash, Target Funds, or derivatives can be included. Derivatives might be used for efficient portfolio management (including risk hedging) and/or investment purposes, and Target Funds to benefit from a specific strategy. For those investments no environmental or social safeguards are applied.



- **Is a specific index designated as a reference benchmark to determine whether this financial product is aligned with the environmental and/or social characteristics that it promotes?**

No reference benchmark has been designated for the purpose of attaining the environmental and/or social characteristics promoted by the Sub-Fund.

Reference benchmarks are indexes to measure whether the financial product attains the environmental or social characteristics that they promote.

- **How is the reference benchmark continuously aligned with each of the environmental or social characteristics promoted by the financial product?**
Not applicable
- **How is the alignment of the investment strategy with the methodology of the index ensured on a continuous basis?**
Not applicable
- **How does the designated index differ from a relevant broad market index?**
Not applicable
- **Where can the methodology used for the calculation of the designated index be found?**
Not applicable



Where can I find more product specific information online?

More product-specific information can be found on the website: <https://regulatory.allianzgi.com/SFDR>

Template pre-contractual disclosure for the financial products referred to in Article 8, paragraphs 1, 2 and 2a, of Regulation (EU) 2019/2088 and Article 6, first paragraph, of Regulation (EU) 2020/852

Product name:

Allianz Euro Bond

Legal entity identifier: 4JPESYE6XYML1UXRJ264

Environmental and/or social characteristics

Sustainable investment means an investment in an economic activity that contributes to an environmental or social objective, provided that the investment does not significantly harm any environmental or social objective and that the investee companies follow good governance practices.

The **EU Taxonomy** is a classification system laid down in Regulation (EU) 2020/852, establishing a list of **environmentally sustainable economic activities**. That Regulation does not include a list of socially sustainable economic activities. Sustainable investments with an environmental objective might be aligned with the Taxonomy or not.

Does this financial product have a sustainable investment objective?	
Yes	No
<input type="checkbox"/> It will make a minimum of sustainable investments with an environmental objective: ___% <ul style="list-style-type: none"> <input type="checkbox"/> in economic activities that qualify as environmentally sustainable under the EU Taxonomy <input type="checkbox"/> in economic activities that do not qualify as environmentally sustainable under the EU Taxonomy 	<input checked="" type="checkbox"/> It promotes Environmental/Social (E/S) characteristics and while it does not have as its objective a sustainable investment, it will have a minimum proportion of 3.00% of sustainable investments <ul style="list-style-type: none"> <input checked="" type="checkbox"/> with an environmental objective in economic activities that qualify as environmentally sustainable under the EU Taxonomy <input checked="" type="checkbox"/> with an environmental objective in economic activities that do not qualify as environmentally sustainable under the EU Taxonomy <input checked="" type="checkbox"/> with a social objective
<input type="checkbox"/> It will make a minimum of sustainable investments with a social objective ___%	<input type="checkbox"/> It promotes E/S characteristics, but will not make any sustainable investments



What environmental and/or social characteristics are promoted by this financial product?

Allianz Euro Bond (the "Sub-Fund") promotes environmental, social, human rights, governance, and business behaviour factors (this domain does not apply for sovereigns issued by a Sovereign Entity) through integration of a best-in-class approach into the Sub-Fund's investment process. This encompasses the evaluation of corporate or sovereign issuers based on an SRI Rating which is used to construct the portfolio.

In addition, sustainable minimum exclusion criteria apply.

No reference benchmark has been designated for the purpose of attaining the environmental and/or social characteristics promoted by the Sub-Fund.

What sustainability indicators are used to measure the attainment of each of the environmental or social characteristics promoted by this financial product?

To measure the attainment of the environmental and/or social characteristics the following sustainability indicators are used and reported on, at the fiscal year end:

- The actual percentage of the Sub-Fund's Portfolio (Portfolio in this respect does not comprise non-rated derivatives and instruments that are non-rated by nature (e. g., cash and deposits)) invested in best-in-class issuers (issuers with a minimum SRI Rating of 2 out of a scale from 0-4) is compared to the actual percentage of the benchmarks best-in-class issuers.
- Confirmation that Principal Adverse Impacts (PAIs) of investment decisions on sustainability factors are considered through the application of exclusion criteria.

Sustainability indicators measure how the environmental or social characteristics promoted by the financial product are attained.

- **What are the objectives of the sustainable investments that the financial product partially intends to make and how does the sustainable investment contribute to such objectives?**

Sustainable investments contribute to environmental and/or social objectives, for which the Investment Manager uses as reference frameworks, among others, the UN Sustainable Development Goals (SDGs), as well as the objectives of the EU Taxonomy:

1. Climate Change Mitigation
2. Climate Change Adaptation
3. Sustainable Use and Protection of Water and Marine Resources
4. Transition to a Circular Economy
5. Pollution Prevention and Control
6. Protection and Restoration of Biodiversity and Ecosystems

The assessment of the positive contribution to the environmental or social objectives is based on a proprietary framework which combines quantitative elements with qualitative inputs from internal research. The methodology applies first a quantitative breakdown of a securities issuer into its business activities. The qualitative element of the framework is an assessment if business activities contribute positively to an environmental or a social objective.

To calculate the positive contribution on the Sub-Fund level the revenue share of each issuer attributable to business activities contributing to environmental and/or social objectives is considered provided the issuer is satisfying the Do No Significant Harm ("DNSH") and Good Governance principles, and an asset-weighted aggregation is performed as a second step. Moreover, for certain types of securities, which finance specific projects contributing to environmental or social objectives the overall investment is considered to contribute to environmental and/or social objectives, but also for these a DNSH as well as a Good Governance check for issuers is performed.

- **How do the sustainable investments that the financial product partially intends to make, not cause significant harm to any environmental or social sustainable investment objective?**

In order to ensure that Sustainable Investments do not significantly harm any other environmental and/or social objective, the Investment Manager is leveraging the PAI indicators, whereby significance thresholds have been defined to identify significantly harmful issuers. Issuers not meeting the significance threshold can be engaged for a limited time period to remediate the adverse impact. Otherwise, if the issuer does not meet the defined significance thresholds twice subsequently or in case of a failed engagement, it does not pass the DNSH assessment. Investments in securities of issuers which do not pass the DNSH assessment are not counted as sustainable investments.

- *How have the indicators for adverse impacts on sustainability factors been taken into account?*

All mandatory PAI indicators are considered either as part of the application of the exclusion criteria or through thresholds on a sectorial or absolute basis. Significance thresholds have been defined and they refer to qualitative or quantitative criteria.

Recognizing the lack of data coverage for some of the PAI indicators equivalent data points are used to assess PAI indicators when applying the DNSH assessment, when relevant, for the following indicators for corporates: share of non-renewable energy consumption and production, activities negatively affecting biodiversity-sensitive areas, emissions to water, lack of processes and compliance mechanisms to monitor compliance with UNGC principles and OECD Guidelines for Multinational Enterprises; for sovereigns: GHG Intensity and investee countries subject to social violations. In case of securities which finance specific projects contributing to environmental or social objectives equivalent data at project level might be used to ensure that Sustainable Investments do not significantly harm any other environmental and/or social objective. The Investment Manager will strive to increase data coverage for PAI indicators with low data coverage by engaging with issuers and data providers. The Investment Manager will regularly evaluate whether the availability of data has increased sufficiently to potentially include assessment of such data in the investment process.

- *How are the sustainable investments aligned with the OECD Guidelines for Multinational Enterprises and the UN Guiding Principles on Business and Human Rights? Details:*

The Investment Manager's sustainable minimum exclusion list screens out companies based on their involvement in controversial practices against international norms. The core normative framework consists of the Principles of the UN Global Compact, the OECD Guidelines for Multinational Enterprises

Principal adverse impacts are the most significant negative impacts of investment decisions on sustainability factors relating to environmental, social and employee matters, respect for human rights, anti-corruption and anti-bribery matters.

and the UN Guiding Principles for Business and Human Rights. Securities issued by companies having a severe violation of these frameworks will be restricted from the investment universe.

The EU Taxonomy sets out a “do not significant harm” principle by which Taxonomy-aligned investments should not significantly harm EU Taxonomy objectives and is accompanied by specific EU criteria.

The “do not significant harm” principle applies only to those investments underlying the financial product that take into account the EU criteria for environmentally sustainable economic activities. The investments underlying the remaining portion of this financial product do not take into account the EU criteria for environmentally sustainable economic activities.

Any other sustainable investments must also not significantly harm any environmental or social objectives.



Does this financial product consider principal adverse impacts on sustainability factors?

Yes

No

The Management Company has joined the Net Zero Asset Manager Initiative and considers PAI indicators through stewardship including engagement, both are relevant to mitigate potential adverse impact as a company.

Due to the commitment to the Net Zero Asset Manager Initiative, the Management Company aims to reduce greenhouse gas emissions in partnership with asset owner clients on decarbonisation goals, consistent with an ambition to reach net zero emission by 2050 or sooner across all assets under management. As part of this objective the Management Company will set an interim target for the proportion of assets to be managed in line with the attainment of net zero emissions by 2050 or sooner.

The Sub-Fund’s Investment Manager considers PAI indicators regarding greenhouse gas emission, biodiversity, water, waste as well as social and employee matters for corporate issuers, and, where relevant, the freedom house index is applied to investments in sovereigns. PAI indicators are considered within the Investment Manager’s investment process through the means of exclusions as described in the “binding elements” section of the Sub-Fund.

The data coverage for the data required for the PAI indicators is heterogenous. The data coverage related to biodiversity, water and waste is low and the related PAI indicators are considered through exclusion of securities issued by companies having a severe violation / breach of principles and guidelines such as the Principles of the United Nations Global Compact, the OECD Guidelines for Multinational Enterprises, and the United Nations Guiding Principles for Business and Human Rights on the grounds of problematic practices around human rights, labour rights, environment, and corruption issues. Therefore, the Investment Manager will strive to increase data coverage for PAI indicators with low data coverage. The Investment Manager will regularly evaluate whether the availability of data has increased sufficiently to potentially include assessment of such data in the investment process.

Additionally, PAI indicators are, among other sustainability factors, applied to derive the SRI Rating. The SRI Rating is used for the portfolio construction.

The following PAI indicators are considered:

Applicable to corporate issuers

- GHG Emissions
- Carbon footprint
- GHG Intensity of investee companies
- Exposure to companies active in the fossil fuel sector
- Activities negatively affecting biodiversity-sensitive areas
- Emissions to water
- Hazardous waste ratio
- Violation of UN Global compact principles
- Lack of processes and compliance mechanisms to monitor compliance with UN Global Compact principles
- Board gender diversity
- Exposure to controversial weapons

Applicable to sovereign and supranational issuers

- Investee countries subject to social violations

The information on the PAI indicators will be available in the end-year report of the Sub-Fund.



The investment strategy guides investment decisions based on factors such as investment objectives and risk tolerance.

What investment strategy does this financial product follow?

Allianz Euro Bond's investment objective is to invest in Debt Securities with Euro exposure of global Bond Markets in accordance with the Sustainable and Responsible Investment Strategy (SRI Strategy).

As part of the SRI best-in-class approach, the Sub-Fund takes environmental, social, human rights, governance, and business behaviour factors into account as follows:

- The aforesaid sustainability factors are analysed through SRI Research by the Investment Manager in order to assess how sustainable development and long-term issues are taken into account in the strategy of an issuer. SRI Research means the overall process of identifying potential risks as well as potential opportunities of an investment in securities of an issuer related to the analysis of sustainability factors. SRI Research data combines external research data (which might have some limitations) with internal analyses.
- Based on a combination of the results of the external and/or internal analyses of the sustainability factors, an internal rating is derived monthly (SRI Rating) and is afterwards assigned to a corporate or sovereign issuer.

This internal SRI Rating is used to rank and select or weight securities for the portfolio construction.

The Sub-Fund's general investment approach (Sub-Fund's applicable General Asset Class Principles in combination with its individual investment restrictions) is described in the prospectus.

● What are the binding elements of the investment strategy used to select the investments to attain each of the environmental or social characteristics promoted by this financial product?

The binding elements are:

- Minimum rating coverage: At least 90% Sub-Fund's portfolio is required to have an SRI Rating (Portfolio in this respect does not comprise non-rated derivatives and instruments that are non-rated by nature (e.g., cash and deposits). While most holdings of the Sub-Fund's will have a corresponding SRI Rating some investments cannot be rated according to the SRI Research methodology. Examples of instruments not attaining to the SRI Rating include, but are not limited to cash, deposits, Target Funds, and non-rated investments.
- The rated instruments are adhering to the minimum rating threshold of 1 (out of a rating scale from 0 – 4; 0 being the worst rating and 4 the best rating)
- Application of the following sustainable minimum exclusion criteria for direct investments:
 - securities issued by companies having a severe violation / breach of principles and guidelines such as the Principles of the United Nations Global Compact, the OECD Guidelines for Multinational Enterprises, and the United Nations Guiding Principles for Business and Human Rights on the grounds of problematic practices around human rights, labour rights, environment, and corruption,
 - securities issued by companies involved in controversial weapons (anti-personnel mines, cluster munitions, chemical weapons, biological weapons, depleted uranium, white phosphorus, and nuclear weapons),
 - securities issued by companies that derive more than 10% of their revenues from weapons, military equipment, and services,
 - securities issued by companies that derive more than 10% of their revenue from thermal coal extraction
 - securities issued by utility companies that generate more than 20% of their revenues from coal,
 - securities issued by companies involved in the production of tobacco, and securities issued by companies involved in the distribution of tobacco with more than 5% of their revenues.

Direct investments in sovereign issuers with an insufficient freedom house index score are excluded.

The sustainable minimum exclusion criteria are based on information from an external data provider and coded in pre- and post-trade compliance. The review is performed at least half yearly.

This sub-fund is invested in assets that cannot be sold at present due to political, economic or other restrictions and/or requirements imposed by third parties over which Allianz Global Investors has no influence. This circumstance leads to the fund being invested in assets which do not or not fully comply with the investment policy of the fund or the sustainable investment approach pursued by the fund. However such investments represents an absolutely marginal position in the sub-fund's assets. As soon as the aforementioned restrictions and/or requirements regarding such assets have been lifted or relaxed and a complete and/or partial sale of the aforementioned assets becomes possible, Allianz Global Investors will immediately make use of this possibility.

- **What is the committed minimum rate to reduce the scope of the investments considered prior to the application of that investment strategy?**

The Sub-Fund does not commit to reduce the scope of the investments by a certain minimum rate.

- **What is the policy to assess good governance practices of the investee companies?**

Good governance principles are considered by screening out companies based on their involvement in controversies around international norms corresponding to the four good governance practices: sound management structures, employee relations, remuneration of staff and tax compliance. Companies having a severe violation in either of those areas will not be investible. For certain cases, flagged issuers shall be on a watch list. These companies will appear on this watch list when the Investment Manager believes that engagement may lead to improvements or when the company is assessed to take remedial actions. Companies on the watch list remain investible unless the Investment Manager believes that the engagement or the remedial actions of the company does not lead to the desired remedy of the severe controversy.

In addition, the Sub-Fund's Investment Manager is committed to actively encourage open dialogues with investee companies on corporate governance, proxy voting and broader sustainability issues in advance of shareholder meetings (regularly for direct investments in shares). The Sub-Fund's Investment Manager's approach to proxy voting and company engagement is set out in the Management Company's Stewardship Statement.

Good governance practices include sound management structures, employee relations, remuneration of staff and tax compliance.



What is the asset allocation planned for this financial product?

Asset allocation describes the share of investments in specific assets.

Min. 90% of the Sub-Funds' assets (excluding cash and non-rated derivatives) are used to meet the environmental or social characteristics promoted by this Sub-Fund. A low portion of the Sub-Fund might contain assets which do not promote environmental or social characteristics. Example of such instruments are derivatives, cash and deposits, some Target Funds and investment with temporarily divergent or absent environmental, social, or good governance qualifications. Min. 3% of the Sub-Funds' assets will be invested in Sustainable Investments. The minimum percentage of investments that are aligned with the EU Taxonomy is 0.01%. The Sub-Fund's Investment Manager does not commit to a minimum share of environmentally Sustainable Investments that are not aligned with the EU Taxonomy. The Sub-Fund's Investment Manager does not commit to a minimum share of socially sustainable investments. While the Sub-Fund cannot commit to a minimum share of environmentally or socially sustainable investments, such investments may be freely allocated to within the Sub-Fund aggregated sustainable investment commitment disclosed (min. 3%).

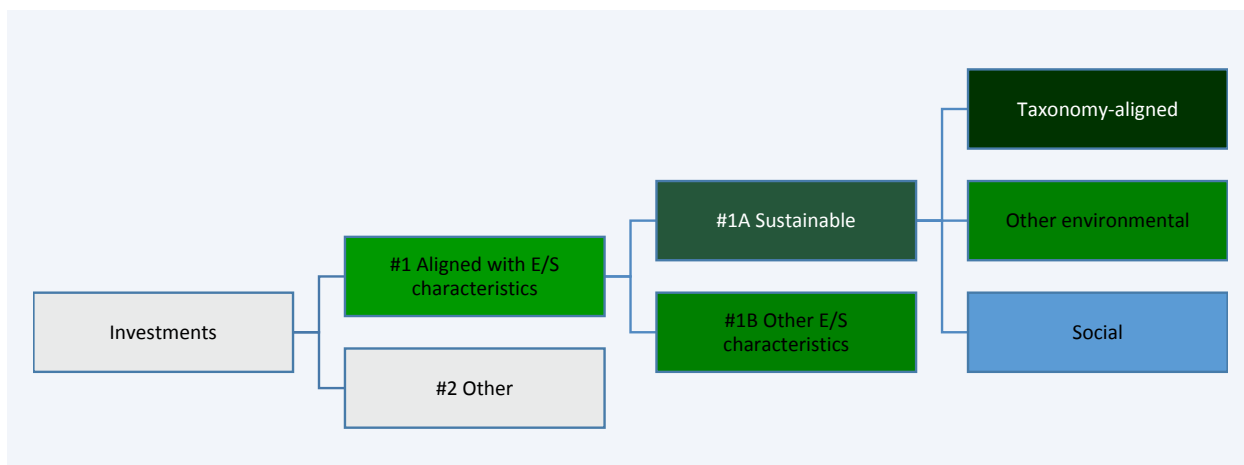

#1 Aligned with E/S characteristics includes the investments of the financial product used to attain the environmental or social characteristics promoted by the financial product.

#2 Other includes the remaining investments of the financial product which are neither aligned with the environmental or social characteristics, nor are qualified as sustainable investments.

The category **#1 Aligned with E/S characteristics** covers:

- The sub-category **#1A Sustainable** covers sustainable investments with environmental or social objectives.

- The sub-category **#1B Other E/S characteristics** covers investments aligned with the environmental or social characteristics that do not qualify as sustainable investments.

- **How does the use of derivatives attain the environmental or social characteristics promoted by the financial product?**

Not applicable



To what minimum extent are sustainable investments with an environmental objective aligned with the EU Taxonomy?

The Taxonomy-aligned investments include debt and/or equity in environmentally sustainable economic activities aligned with the EU-Taxonomy. The minimum percentage of investments that are aligned with the EU Taxonomy is 0.01%. Taxonomy-aligned data is provided by an external data provider. The Investment Manager has assessed the quality of such data. The data will not be subject to an assurance provided by auditors or a review by third parties. The data will not reflect any data in government bonds. As of today, there is no recognized methodology available to determine the proportion of Taxonomy-aligned activities when investing in government bonds.

Taxonomy-aligned activities in this disclosure are based on share of turnover. Pre-contractual figures use turnover as its financial metric as a default in line with the regulatory requirements and based on the fact that complete, verifiable or up-to date data for CAPEX and/or OPEX as financial metric is even less available.

Taxonomy-aligned data is only in rare cases data reported by companies in accordance with the EU Taxonomy. The data provider has derived Taxonomy-aligned data from other available equivalent public data.

- **Does the financial product invest in fossil gas and/or nuclear energy related activities that comply with the EU Taxonomy ¹?**

Yes:

In fossil gas In nuclear energy

No

The Sub-Fund does not pursue any investments in fossil gas and/or nuclear energy related activities that comply with the EU Taxonomy. Nevertheless, as result of this investment strategy, investments may occur in corporates which are also active in these activities. Further information will be provided as part of the annual reporting, if relevant.

Taxonomy-aligned activities are expressed as a share of:

- **turnover** reflecting the share of revenue from green activities of investee companies
- **capital expenditure (CapEx)** showing the green investments made by investee companies, e.g. for a transition to a green

¹ Fossil gas and/or nuclear related activities will only comply with the EU Taxonomy where they contribute to limiting climate change ("climate change mitigation") and do not significantly harm any EU Taxonomy objective - see explanatory note in the left hand margin. The full criteria for fossil gas and nuclear energy economic activities that comply with the EU Taxonomy are laid down in Commission Delegated Regulation (EU) 2022/1214.

economy.
 - **operational expenditure (OpEx)** reflecting green operational activities of investee companies.

The two graphs below show in green the minimum percentage of investments that are aligned with the EU Taxonomy. As there is no appropriate methodology to determine the Taxonomy-alignment of sovereign bonds*, the first graph shows the Taxonomy-alignment in relation to all the investments of the financial product including sovereign bonds, while the second graph shows the Taxonomy-alignment only in relation to the investments of the financial product other than sovereign bonds.

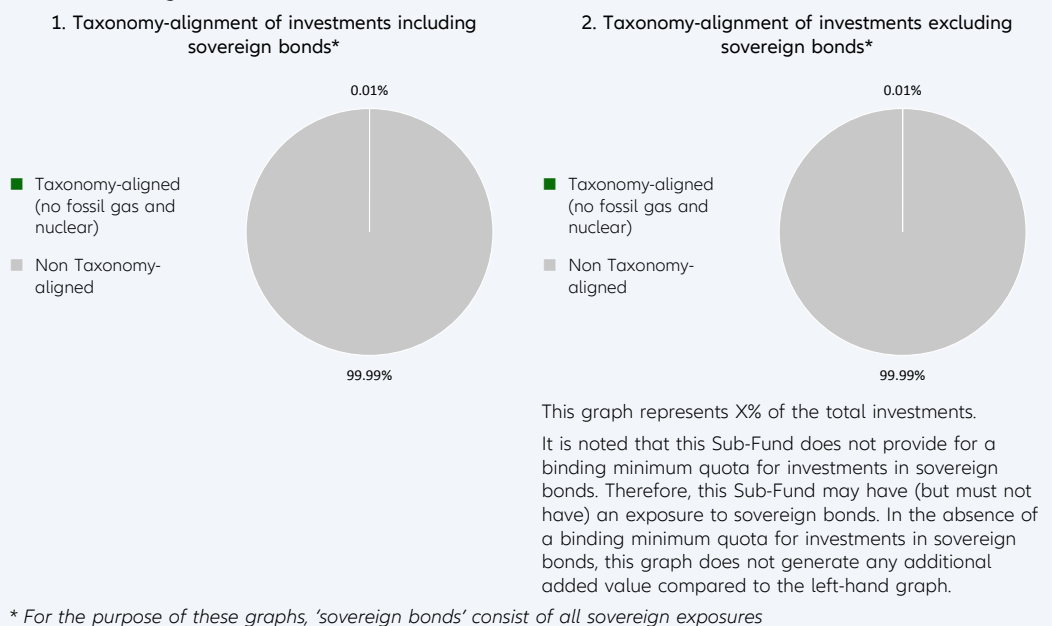

Enabling activities directly enable other activities to make a substantial contribution to an environmental objective.

● **What is the minimum share of investments in transitional and enabling activities?**

The Sub-Fund's Investment Manager does not commit to a split of minimum taxonomy alignment into transitional, enabling activities and own performance.

Transitional activities are activities for which low-carbon alternatives are not yet available and among others have greenhouse gas emission levels corresponding to the best performance.



What is the minimum share of sustainable investments with an environmental objective that are not aligned with the EU Taxonomy?

Taxonomy-aligned investments are considered a sub-category of Sustainable Investments. If an investment is not Taxonomy-aligned since the activity is not yet covered under the EU Taxonomy or the positive contribution is not substantial enough to comply with the Taxonomy technical screening criteria, the investment can still be considered an environmentally Sustainable Investment provided it complies with all criteria. The Investment Manager does not commit to a minimum share of environmentally Sustainable Investments that are not aligned with the EU Taxonomy. The overall sustainable investment share may also include investments with an environmental objective in economic activities that do not qualify as environmentally sustainable under the EU Taxonomy, and while the Sub-Fund cannot commit to a minimum share of environmentally or socially sustainable investments, such investments may be freely allocated to within the Sub-Fund aggregated sustainable investment commitment disclosed (min. 3%).

are sustainable investments with an environmental objective that **do not take into account the criteria** for environmentally sustainable economic activities under the EU Taxonomy.



What is the minimum share of socially sustainable investments?

The Investment Manager defines Sustainable Investments based on internal research, which uses, among others, the UN Sustainable Development Goals (SDGs), as well as the objectives of the EU Taxonomy as reference frameworks. The Investment Manager does not commit to a minimum share of socially Sustainable Investments, as the SDGs contain environmental as well as social objectives. The overall sustainable investment share may also include investments with a social objective, and while the Sub-Fund cannot commit to a minimum share of environmentally or socially sustainable investments, such investments may be freely allocated to within the Sub-Fund aggregated sustainable investment commitment disclosed (min. 3%).



What investments are included under “#2 Other”, what is their purpose and are there any minimum environmental or social safeguards?

Under “#2 Other” investments into cash, Target Funds, or derivatives can be included. Derivatives might be used for efficient portfolio management (including risk hedging) and/or investment purposes, and Target Funds to benefit from a specific strategy. For those investments no environmental or social safeguards are applied.



Is a specific index designated as a reference benchmark to determine whether this financial product is aligned with the environmental and/or social characteristics that it promotes?

No reference benchmark has been designated for the purpose of attaining the environmental and/or social characteristics promoted by the Sub-Fund.

- How is the reference benchmark continuously aligned with each of the environmental or social characteristics promoted by the financial product?

Not applicable

- How is the alignment of the investment strategy with the methodology of the index ensured on a continuous basis?

Not applicable

- How does the designated index differ from a relevant broad market index?

Not applicable

- Where can the methodology used for the calculation of the designated index be found?

Not applicable

Reference benchmarks are indexes to measure whether the financial product attains the environmental or social characteristics that they promote.



Where can I find more product specific information online?

More product-specific information can be found on the website: <https://regulatory.allianzgi.com/SFDR>

Template pre-contractual disclosure for the financial products referred to in Article 8, paragraphs 1, 2 and 2a, of Regulation (EU) 2019/2088 and Article 6, first paragraph, of Regulation (EU) 2020/852

Product name:

Allianz Euro Bond Short Term 1-3 Plus

Legal entity identifier: 5493007JLYJUUN37K611

Environmental and/or social characteristics

Sustainable investment means an investment in an economic activity that contributes to an environmental or social objective, provided that the investment does not significantly harm any environmental or social objective and that the investee companies follow good governance practices.

The **EU Taxonomy** is a classification system laid down in Regulation (EU) 2020/852, establishing a list of **environmentally sustainable economic activities**. That Regulation does not include a list of socially sustainable economic activities. Sustainable investments with an environmental objective might be aligned with the Taxonomy or not.

Does this financial product have a sustainable investment objective?	
<input checked="" type="radio"/> <input checked="" type="radio"/> Yes	<input checked="" type="radio"/> <input type="radio"/> No
<input type="checkbox"/> It will make a minimum of sustainable investments with an environmental objective: ___% <ul style="list-style-type: none"> <input type="checkbox"/> in economic activities that qualify as environmentally sustainable under the EU Taxonomy <input type="checkbox"/> in economic activities that do not qualify as environmentally sustainable under the EU Taxonomy 	<input checked="" type="checkbox"/> It promotes Environmental/Social (E/S) characteristics and while it does not have as its objective a sustainable investment, it will have a minimum proportion of 1.00% of sustainable investments <ul style="list-style-type: none"> <input checked="" type="checkbox"/> with an environmental objective in economic activities that qualify as environmentally sustainable under the EU Taxonomy <input checked="" type="checkbox"/> with an environmental objective in economic activities that do not qualify as environmentally sustainable under the EU Taxonomy <input checked="" type="checkbox"/> with a social objective
<input type="checkbox"/> It will make a minimum of sustainable investments with a social objective ___%	<input type="checkbox"/> It promotes E/S characteristics, but will not make any sustainable investments



What environmental and/or social characteristics are promoted by this financial product?

Allianz Euro Bond Short Term 1-3 Plus (the "Sub-Fund") promotes environmental, social, human rights, governance, and business behaviour factors (this domain does not apply for sovereigns issued by a Sovereign Entity) through integration of a best-in-class approach into the Sub-Fund's investment process. This encompasses the evaluation of corporate or sovereign issuers based on an SRI Rating which is used to construct the portfolio.

In addition, sustainable minimum exclusion criteria apply.

No reference benchmark has been designated for the purpose of attaining the environmental and/or social characteristics promoted by the Sub-Fund.

● What sustainability indicators are used to measure the attainment of each of the environmental or social characteristics promoted by this financial product?

To measure the attainment of the environmental and/or social characteristics the following sustainability indicators are used and reported on, at the fiscal year end:

- The actual percentage of the Sub-Fund's Portfolio (Portfolio in this respect does not comprise non-rated derivatives and instruments that are non-rated by nature (e. g., cash and deposits)) assets invested in best-in-class issuers (issuers with a minimum SRI Rating of 2 out of a scale from 0-4; 0 being the worst rating and 4 the best rating) is compared to the actual percentage of the benchmarks best-in-class issuers.
- Confirmation that Principal Adverse Impacts (PAIs) of investment decisions on sustainability factors are considered through the application of exclusion criteria.

Sustainability indicators measure how the environmental or social characteristics promoted by the financial product are attained.

- **What are the objectives of the sustainable investments that the financial product partially intends to make and how does the sustainable investment contribute to such objectives?**

Sustainable investments contribute to environmental and/or social objectives, for which the Investment Manager uses as reference frameworks, among others, the UN Sustainable Development Goals (SDGs), as well as the objectives of the EU Taxonomy:

1. Climate Change Mitigation
2. Climate Change Adaptation
3. Sustainable Use and Protection of Water and Marine Resources
4. Transition to a Circular Economy
5. Pollution Prevention and Control
6. Protection and Restoration of Biodiversity and Ecosystems

The assessment of the positive contribution to the environmental or social objectives is based on a proprietary framework which combines quantitative elements with qualitative inputs from internal research. The methodology applies first a quantitative breakdown of a securities issuer into its business activities. The qualitative element of the framework is an assessment if business activities contribute positively to an environmental or a social objective.

To calculate the positive contribution on the Sub-Fund level the revenue share of each issuer attributable to business activities contributing to environmental and/or social objectives is considered provided the issuer is satisfying the Do No Significant Harm ("DNSH") and Good Governance principles, and an asset-weighted aggregation is performed as a second step. Moreover, for certain types of securities, which finance specific projects contributing to environmental or social objectives the overall investment is considered to contribute to environmental and/or social objectives, but also for these a DNSH as well as a Good Governance check for issuers is performed.

- **How do the sustainable investments that the financial product partially intends to make, not cause significant harm to any environmental or social sustainable investment objective?**

In order to ensure that Sustainable Investments do not significantly harm any other environmental and/or social objective, the Investment Manager is leveraging the PAI indicators, whereby significance thresholds have been defined to identify significantly harmful issuers. Issuers not meeting the significance threshold can be engaged for a limited time period to remediate the adverse impact. Otherwise, if the issuer does not meet the defined significance thresholds twice subsequently or in case of a failed engagement, it does not pass the DNSH assessment. Investments in securities of issuers which do not pass the DNSH assessment are not counted as sustainable investments.

- *How have the indicators for adverse impacts on sustainability factors been taken into account?*

All mandatory PAI indicators are considered either as part of the application of the exclusion criteria or through thresholds on a sectorial or absolute basis. Significance thresholds have been defined and they refer to qualitative or quantitative criteria.

Recognizing the lack of data coverage for some of the PAI indicators equivalent data points are used to assess PAI indicators when applying the DNSH assessment, when relevant, for the following indicators for corporates: share of non-renewable energy consumption and production, activities negatively affecting biodiversity-sensitive areas, emissions to water, lack of processes and compliance mechanisms to monitor compliance with UNGC principles and OECD Guidelines for Multinational Enterprises; for sovereigns: GHG Intensity and investee countries subject to social violations. In case of securities which finance specific projects contributing to environmental or social objectives equivalent data at project level might be used to ensure that Sustainable Investments do not significantly harm any other environmental and/or social objective. The Investment Manager will strive to increase data coverage for PAI indicators with low data coverage by engaging with issuers and data providers. The Investment Manager will regularly evaluate whether the availability of data has increased sufficiently to potentially include assessment of such data in the investment process.

- *How are the sustainable investments aligned with the OECD Guidelines for Multinational Enterprises and the UN Guiding Principles on Business and Human Rights? Details:*

The Investment Manager's sustainable minimum exclusion list screens out companies based on their involvement in controversial practices against international norms. The core normative framework consists of the Principles of the UN Global Compact, the OECD Guidelines for Multinational Enterprises

Principal adverse impacts are the most significant negative impacts of investment decisions on sustainability factors relating to environmental, social and employee matters, respect for human rights, anti-corruption and anti-bribery matters.

and the UN Guiding Principles for Business and Human Rights. Securities issued by companies having a severe violation of these frameworks will be restricted from the investment universe.

The EU Taxonomy sets out a “do not significant harm” principle by which Taxonomy-aligned investments should not significantly harm EU Taxonomy objectives and is accompanied by specific EU criteria.

The “do not significant harm” principle applies only to those investments underlying the financial product that take into account the EU criteria for environmentally sustainable economic activities. The investments underlying the remaining portion of this financial product do not take into account the EU criteria for environmentally sustainable economic activities.

Any other sustainable investments must also not significantly harm any environmental or social objectives.



Does this financial product consider principal adverse impacts on sustainability factors?

Yes

No

The Management Company has joined the Net Zero Asset Manager Initiative and considers PAI indicators through stewardship including engagement, both are relevant to mitigate potential adverse impact as a company.

Due to the commitment to the Net Zero Asset Manager Initiative, the Management Company aims to reduce greenhouse gas emissions in partnership with asset owner clients on decarbonisation goals, consistent with an ambition to reach net zero emission by 2050 or sooner across all assets under management. As part of this objective the Management Company will set an interim target for the proportion of assets to be managed in line with the attainment of net zero emissions by 2050 or sooner.

The Sub-Fund’s Investment Manager considers PAI indicators regarding greenhouse gas emission, biodiversity, water, waste as well as social and employee matters for corporate issuers, and, where relevant, the freedom house index is applied to investments in sovereigns. PAI indicators are considered within the Investment Manager’s investment process through the means of exclusions as described in the “binding elements” section of the Sub-Fund.

The data coverage for the data required for the PAI indicators is heterogenous. The data coverage related to biodiversity, water and waste is low and the related PAI indicators are considered through exclusion of securities issued by companies having a severe violation / breach of principles and guidelines such as the Principles of the United Nations Global Compact, the OECD Guidelines for Multinational Enterprises, and the United Nations Guiding Principles for Business and Human Rights on the grounds of problematic practices around human rights, labour rights, environment, and corruption issues. Therefore, the Investment Manager will strive to increase data coverage for PAI indicators with low data coverage. The Investment Manager will regularly evaluate whether the availability of data has increased sufficiently to potentially include assessment of such data in the investment process.

Additionally, PAI indicators are, among other sustainability factors, applied to derive the SRI Rating. The SRI Rating is used for the portfolio construction.

The following PAI indicators are considered:

Applicable to corporate issuers

- GHG Emissions
- Carbon footprint
- GHG Intensity of investee companies
- Exposure to companies active in the fossil fuel sector
- Activities negatively affecting biodiversity-sensitive areas
- Emissions to water
- Hazardous waste ratio
- Violation of UN Global compact principles
- Lack of processes and compliance mechanisms to monitor compliance with UN Global Compact principles
- Board gender diversity
- Exposure to controversial weapons

Applicable to sovereign and supranational issuers

- Investee countries subject to social violations

The information on the PAI indicators will be available in the end-year report of the Sub-Fund.



The investment strategy guides investment decisions based on factors such as investment objectives and risk tolerance.

What investment strategy does this financial product follow?

Allianz Euro Bond Short Term 1-3 Plus's investment objective is to invest in Debt Securities with Euro exposure of global Bonds Markets in accordance with the Sustainable and Responsible Investment Strategy (SRI Strategy).

As part of the SRI best-in-class approach, the Sub-Fund takes environmental, social, human rights, governance, and business behaviour factors into account as follows:

- The aforesaid sustainability factors are analysed through SRI Research by the Investment Manager in order to assess how sustainable development and long-term issues are taken into account in the strategy of an issuer. SRI Research means the overall process of identifying potential risks as well as potential opportunities of an investment in securities of an issuer related to the analysis of sustainability factors. SRI Research data combines external research data (which might have some limitations) with internal analyses.
- Based on a combination of the results of the external and/or internal analyses of the sustainability factors, an internal rating is derived monthly (SRI Rating) and is afterwards assigned to a corporate or sovereign issuer.

This internal SRI Rating is used to rank and select or weight securities for the portfolio construction.

The Sub-Fund's general investment approach (Sub-Fund's applicable General Asset Class Principles in combination with its individual investment restrictions) is described in the prospectus.

● What are the binding elements of the investment strategy used to select the investments to attain each of the environmental or social characteristics promoted by this financial product?

The binding elements are:

- Minimum rating coverage: At least 90% of the Sub-Fund's portfolio is required to have an SRI Rating (portfolio in this respect does not comprise non-rated derivatives and instruments that are non-rated by nature e.g., cash and deposits). While most holdings of the Sub-Fund will have a corresponding SRI Rating some investments cannot be rated according to the SRI Research methodology. Examples of instruments not attaining to the SRI Rating include, but are not limited to cash, deposits, Target Funds, and non-rated investments.
- The rated instruments are adhering to the minimum rating threshold of 1 (out of a rating scale from 0 – 4; 0 being the worst rating and 4 the best rating).
- Application of the following sustainable minimum exclusion criteria for direct investments:
 - securities issued by companies having a severe violation / breach of principles and guidelines such as the Principles of the United Nations Global Compact, the OECD Guidelines for Multinational Enterprises, and the United Nations Guiding Principles for Business and Human Rights on the grounds of problematic practices around human rights, labour rights, environment, and corruption issues,
 - securities issued by companies involved in controversial weapons (anti-personnel mines, cluster munitions, chemical weapons, biological weapons, depleted uranium, white phosphorus, and nuclear weapons),
 - securities issued by companies that derive more than 10% of their revenues from weapons, military equipment, and services,
 - securities issued by companies that derive more than 10% of their revenue from thermal coal extraction,
 - securities issued by utility companies that generate more than 20% of their revenues from coal,
 - securities issued by companies involved in the production of tobacco, and securities issued by companies involved in the distribution of tobacco with more than 5% of their revenues.

Direct investments in sovereign issuers with an insufficient freedom house index score are excluded.

The sustainable minimum exclusion criteria are based on information from an external data provider and coded in pre- and post-trade compliance. The review is performed at least half yearly.

- **What is the committed minimum rate to reduce the scope of the investments considered prior to the application of that investment strategy?**

The Sub-Fund does not commit to reduce the scope of the investments by a certain minimum rate.

- **What is the policy to assess good governance practices of the investee companies?**

Good governance principles are considered by screening out companies based on their involvement in controversies around international norms corresponding to the four good governance practices: sound management structures, employee relations, remuneration of staff and tax compliance. Companies having a severe violation in either of those areas will not be investible. For certain cases, flagged issuers shall be on a watch list. These companies will appear on this watch list when the Investment Manager believes that engagement may lead to improvements or when the company is assessed to take remedial actions. Companies on the watch list remain investible unless the Investment Manager believes that the engagement or the remedial actions of the company does not lead to the desired remedy of the severe controversy.

In addition, the Sub-Fund’s Investment Manager is committed to actively encourage open dialogues with investee companies on corporate governance, proxy voting and broader sustainability issues in advance of shareholder meetings (regularly for direct investments in shares). The Sub-Fund’s Investment Manager’s approach to proxy voting and company engagement is set out in the Management Company’s Stewardship Statement.

Good governance practices include sound management structures, employee relations, remuneration of staff and tax compliance.



What is the asset allocation planned for this financial product?

Asset allocation describes the share of investments in specific assets.

Min. 90% of the Sub-Funds’ assets (excluding cash and non-rated derivatives) are used to meet the environmental or social characteristics promoted by this Sub-Fund. A low portion of the Sub-Fund might contain assets which do not promote environmental or social characteristics. Examples of such instruments are derivatives, cash and deposits, some Target Funds and investment with temporarily divergent or absent environmental, social, or good governance qualifications. Min. 1% of the Sub-Funds’ assets will be invested in Sustainable Investments. The minimum percentage of investments that are aligned with the EU Taxonomy is 0.01%. The Sub-Fund’s Investment Manager does not commit to a minimum share of environmentally Sustainable Investments that are not aligned with the EU Taxonomy. The Sub-Fund’s Investment Manager does not commit to a minimum share of socially sustainable investments. While the Sub-Fund cannot commit to a minimum share of environmentally or socially sustainable investments, such investments may be freely allocated to within the Sub-Fund aggregated sustainable investment commitment disclosed (min. 1%).

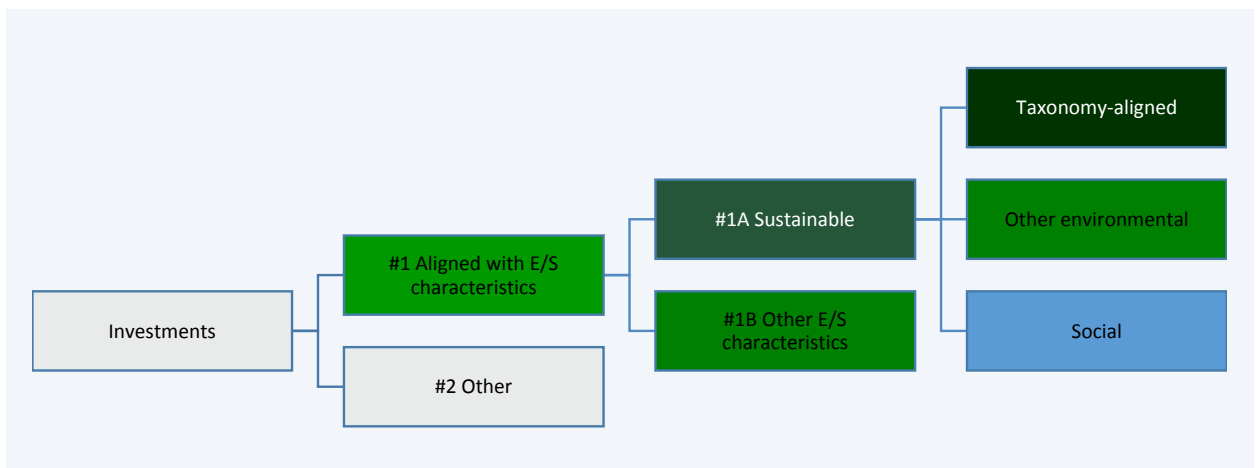

#1 Aligned with E/S characteristics includes the investments of the financial product used to attain the environmental or social characteristics promoted by the financial product.

#2 Other includes the remaining investments of the financial product which are neither aligned with the environmental or social characteristics, nor are qualified as sustainable investments.

The category **#1 Aligned with E/S characteristics** covers:

- The sub-category **#1A Sustainable** covers sustainable investments with environmental or social objectives.
- The sub-category **#1B Other E/S characteristics** covers investments aligned with the environmental or social characteristics that do not qualify as sustainable investments.

- How does the use of derivatives attain the environmental or social characteristics promoted by the financial product?

Not applicable



To what minimum extent are sustainable investments with an environmental objective aligned with the EU Taxonomy?

The Taxonomy-aligned investments include debt and/or equity in environmentally sustainable economic activities aligned with the EU-Taxonomy. The minimum percentage of investments that are aligned with the EU Taxonomy is 0.01%. Taxonomy-aligned data is provided by an external data provider. The Investment Manager has assessed the quality of such data. The data will not be subject to an assurance provided by auditors or a review by third parties. The data will not reflect any data in government bonds. As of today, there is no recognized methodology available to determine the proportion of Taxonomy-aligned activities when investing in government bonds.

Taxonomy-aligned activities in this disclosure are based on share of turnover. Pre-contractual figures use turnover as its financial metric as a default in line with the regulatory requirements and based on the fact that complete, verifiable or up-to date data for CAPEX and/or OPEX as financial metric is even less available.

Taxonomy-aligned data is only in rare cases data reported by companies in accordance with the EU Taxonomy. The data provider has derived Taxonomy-aligned data from other available equivalent public data.

- Does the financial product invest in fossil gas and/or nuclear energy related activities that comply with the EU Taxonomy ¹?

Yes:

In fossil gas In nuclear energy

No

The Sub-Fund does not pursue any investments in fossil gas and/or nuclear energy related activities that comply with the EU Taxonomy. Nevertheless, as result of this investment strategy, investments may occur in corporates which are also active in these activities. Further information will be provided as part of the annual reporting, if relevant.

The two graphs below show in green the minimum percentage of investments that are aligned with the EU Taxonomy. As there is no appropriate methodology to determine the Taxonomy-alignment of sovereign bonds*, the first graph shows the Taxonomy-alignment in relation to all the investments of the financial product including sovereign bonds, while the second graph shows the Taxonomy-alignment only in relation to the investments of the financial product other than sovereign bonds.

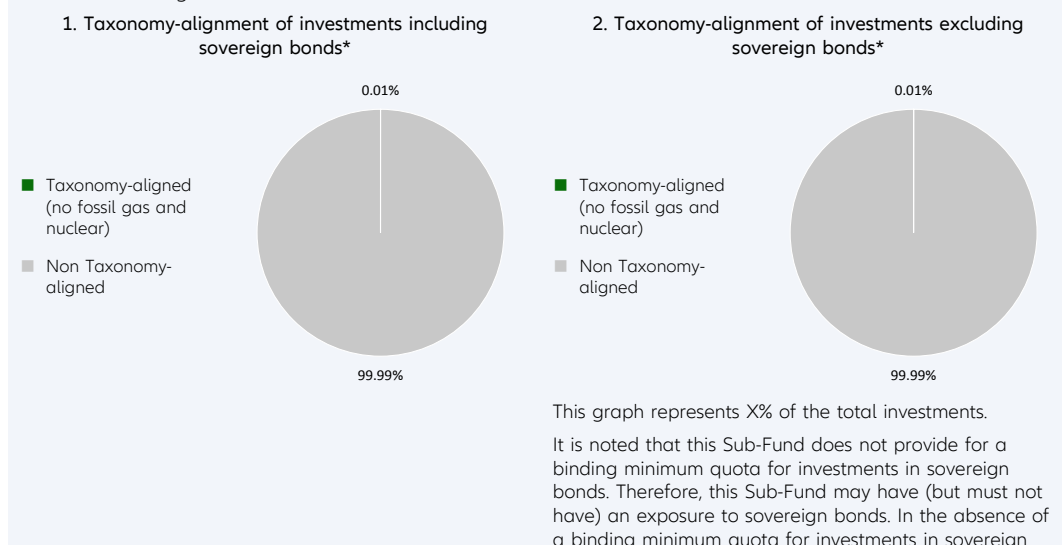

¹ Fossil gas and/or nuclear related activities will only comply with the EU Taxonomy where they contribute to limiting climate change ("climate change mitigation") and do not significantly harm any EU Taxonomy objective - see explanatory note in the left hand margin. The full criteria for fossil gas and nuclear energy economic activities that comply with the EU Taxonomy are laid down in Commission Delegated Regulation (EU) 2022/1214.

bonds, this graph does not generate any additional added value compared to the left-hand graph.

* For the purpose of these graphs, 'sovereign bonds' consist of all sovereign exposures

Enabling activities directly enable other activities to make a substantial contribution to an environmental objective.

Transitional activities are activities for which low-carbon alternatives are not yet available and among others have greenhouse gas emission levels corresponding to the best performance.

● What is the minimum share of investments in transitional and enabling activities?

The Sub-Fund's Investment Manager does not commit to a split of minimum taxonomy alignment into transitional, enabling activities and own performance.



What is the minimum share of sustainable investments with an environmental objective that are not aligned with the EU Taxonomy?

Taxonomy-aligned investments are considered a sub-category of Sustainable Investments. If an investment is not Taxonomy-aligned since the activity is not yet covered under the EU Taxonomy or the positive contribution is not substantial enough to comply with the Taxonomy technical screening criteria, the investment can still be considered an environmentally Sustainable Investment provided it complies with all criteria. The Investment Manager does not commit to a minimum share of environmentally Sustainable Investments that are not aligned with the EU Taxonomy. The overall sustainable investment share may also include investments with an environmental objective in economic activities that do not qualify as environmentally sustainable under the EU Taxonomy, and while the Sub-Fund cannot commit to a minimum share of environmentally or socially sustainable investments, such investments may be freely allocated to within the Sub-Fund aggregated sustainable investment commitment disclosed (min. 1%).



are sustainable investments with an environmental objective that **do not take into account the criteria** for environmentally sustainable economic activities under the EU Taxonomy.



What is the minimum share of socially sustainable investments?

The Investment Manager defines Sustainable Investments based on internal research, which uses, among others, the UN Sustainable Development Goals (SDGs), as well as the objectives of the EU Taxonomy as reference frameworks. The Investment Manager does not commit to a minimum share of socially Sustainable Investments, as the SDGs contain environmental as well as social objectives. The overall sustainable investment share may also include investments with a social objective, and while the Sub-Fund cannot commit to a minimum share of environmentally or socially sustainable investments, such investments may be freely allocated to within the Sub-Fund aggregated sustainable investment commitment disclosed (min. 1%).



What investments are included under "#2 Other", what is their purpose and are there any minimum environmental or social safeguards?

Under "#2 Other" investments into cash, Target Funds, or derivatives can be included. Derivatives might be used for efficient portfolio management (including risk hedging) and/or investment purposes, and Target Funds to benefit from a specific strategy. For those investments no environmental or social safeguards are applied.



Is a specific index designated as a reference benchmark to determine whether this financial product is aligned with the environmental and/or social characteristics that it promotes?

No reference benchmark has been designated for the purpose of attaining the environmental and/or social characteristics promoted by the Sub-Fund.

Reference benchmarks are indexes to measure whether the financial product attains the environmental or social characteristics that they promote.

- **How is the reference benchmark continuously aligned with each of the environmental or social characteristics promoted by the financial product?**
Not applicable
- **How is the alignment of the investment strategy with the methodology of the index ensured on a continuous basis?**
Not applicable
- **How does the designated index differ from a relevant broad market index?**
Not applicable
- **Where can the methodology used for the calculation of the designated index be found?**
Not applicable



Where can I find more product specific information online?

More product-specific information can be found on the website: <https://regulatory.allianzgi.com/SFDR>

Template pre-contractual disclosure for the financial products referred to in Article 8, paragraphs 1, 2 and 2a, of Regulation (EU) 2019/2088 and Article 6, first paragraph, of Regulation (EU) 2020/852

Product name:

Allianz Euro Credit SRI

Legal entity identifier: 529900VVLGKMM7VV9P20

Environmental and/or social characteristics

Sustainable investment means an investment in an economic activity that contributes to an environmental or social objective, provided that the investment does not significantly harm any environmental or social objective and that the investee companies follow good governance practices.

The **EU Taxonomy** is a classification system laid down in Regulation (EU) 2020/852, establishing a list of **environmentally sustainable economic activities**. That Regulation does not include a list of socially sustainable economic activities. Sustainable investments with an environmental objective might be aligned with the Taxonomy or not.

Does this financial product have a sustainable investment objective?

Yes

No

It will make a minimum of **sustainable investments with an environmental objective**: ____%

in economic activities that qualify as environmentally sustainable under the EU Taxonomy

in economic activities that do not qualify as environmentally sustainable under the EU Taxonomy

It will make a minimum of **sustainable investments with a social objective** ____%

It **promotes Environmental/Social (E/S) characteristics** and while it does not have as its objective a sustainable investment, it will have a minimum proportion of **15.00%** of sustainable investments

with an environmental objective in economic activities that qualify as environmentally sustainable under the EU Taxonomy

with an environmental objective in economic activities that do not qualify as environmentally sustainable under the EU Taxonomy

with a social objective

It promotes E/S characteristics, but **will not make any sustainable investments**



What environmental and/or social characteristics are promoted by this financial product?

Allianz Euro Credit SRI (the "Sub-Fund") promotes environmental, social, human rights, governance, and business behaviour factors (this domain does not apply for sovereigns issued by a Sovereign Entity) through integration of a best-in-class approach into the Sub-Fund's investment process. This encompasses the evaluation of corporate or sovereign issuers based on an SRI Rating which is used to construct the portfolio.

In addition, sustainable minimum exclusion criteria apply.

No reference benchmark has been designated for the purpose of attaining the environmental and/or social characteristics promoted by the Sub-Fund.

● What sustainability indicators are used to measure the attainment of each of the environmental or social characteristics promoted by this financial product?

To measure the attainment of the environmental and/or social characteristics the following sustainability indicators are used and reported on, at the fiscal year end:

- The actual percentage of the Sub-Fund's Portfolio (Portfolio in this respect does not comprise non-rated derivatives and instruments that are non-rated by nature (e. g., cash and deposits)) invested in best-in-class issuers (issuers with a minimum SRI Rating of 2 out of a scale from 0-4) is compared to the actual percentage of the benchmarks best-in-class issuers.
- Adherence to a 20% reduction of the investment universe.

Sustainability indicators measure how the environmental or social characteristics promoted by the financial product are attained.

- Confirmation that Principal Adverse Impacts (PAIs) of investment decisions on sustainability factors are considered through the application of exclusion criteria.

- **What are the objectives of the sustainable investments that the financial product partially intends to make and how does the sustainable investment contribute to such objectives?**

Sustainable investments contribute to environmental and/or social objectives, for which the Investment Manager uses as reference frameworks, among others, the UN Sustainable Development Goals (SDGs), as well as the objectives of the EU Taxonomy:

1. Climate Change Mitigation
2. Climate Change Adaptation
3. Sustainable Use and Protection of Water and Marine Resources
4. Transition to a Circular Economy
5. Pollution Prevention and Control
6. Protection and Restoration of Biodiversity and Ecosystems

The assessment of the positive contribution to the environmental or social objectives is based on a proprietary framework which combines quantitative elements with qualitative inputs from internal research. The methodology applies first a quantitative breakdown of a securities issuer into its business activities. The qualitative element of the framework is an assessment if business activities contribute positively to an environmental or a social objective.

To calculate the positive contribution on the Sub-Fund level the revenue share of each issuer attributable to business activities contributing to environmental and/or social objectives is considered provided the issuer is satisfying the Do No Significant Harm (“DNSH”) and Good Governance principles, and an asset-weighted aggregation is performed as a second step. Moreover, for certain types of securities, which finance specific projects contributing to environmental or social objectives the overall investment is considered to contribute to environmental and/or social objectives, but also for these a DNSH as well as a Good Governance check for issuers is performed.

- **How do the sustainable investments that the financial product partially intends to make, not cause significant harm to any environmental or social sustainable investment objective?**

In order to ensure that Sustainable Investments do not significantly harm any other environmental and/or social objective, the Investment Manager is leveraging the PAI indicators, whereby significance thresholds have been defined to identify significantly harmful issuers. Issuers not meeting the significance threshold can be engaged for a limited time period to remediate the adverse impact. Otherwise, if the issuer does not meet the defined significance thresholds twice subsequently or in case of a failed engagement, it does not pass the DNSH assessment. Investments in securities of issuers which do not pass the DNSH assessment are not counted as sustainable investments.

- *How have the indicators for adverse impacts on sustainability factors been taken into account?*

All mandatory PAI indicators are considered either as part of the application of the exclusion criteria or through thresholds on a sectorial or absolute basis. Significance thresholds have been defined and they refer to qualitative or quantitative criteria.

Recognizing the lack of data coverage for some of the PAI indicators equivalent data points are used to assess PAI indicators when applying the DNSH assessment, when relevant, for the following indicators for corporates: share of non-renewable energy consumption and production, activities negatively affecting biodiversity-sensitive areas, emissions to water, lack of processes and compliance mechanisms to monitor compliance with UNGC principles and OECD Guidelines for Multinational Enterprises; for sovereigns: GHG Intensity and investee countries subject to social violations. In case of securities which finance specific projects contributing to environmental or social objectives equivalent data at project level might be used to ensure that Sustainable Investments do not significantly harm any other environmental and/or social objective. The Investment Manager will strive to increase data coverage for PAI indicators with low data coverage by engaging with issuers and data providers. The Investment Manager will regularly evaluate whether the availability of data has increased sufficiently to potentially include assessment of such data in the investment process.

Principal adverse impacts are the most significant negative impacts of investment decisions on sustainability factors relating to environmental, social and employee matters, respect for human rights, anti-corruption and anti-bribery matters.

- *How are the sustainable investments aligned with the OECD Guidelines for Multinational Enterprises and the UN Guiding Principles on Business and Human Rights? Details:*

The Investment Manager's sustainable minimum exclusion list screens out companies based on their involvement in controversial practices against international norms. The core normative framework consists of the Principles of the UN Global Compact, the OECD Guidelines for Multinational Enterprises and the UN Guiding Principles for Business and Human Rights. Securities issued by companies having a severe violation of these frameworks will be restricted from the investment universe.

The EU Taxonomy sets out a "do not significant harm" principle by which Taxonomy-aligned investments should not significantly harm EU Taxonomy objectives and is accompanied by specific EU criteria.

The "do not significant harm" principle applies only to those investments underlying the financial product that take into account the EU criteria for environmentally sustainable economic activities. The investments underlying the remaining portion of this financial product do not take into account the EU criteria for environmentally sustainable economic activities.

Any other sustainable investments must also not significantly harm any environmental or social objectives.



Does this financial product consider principal adverse impacts on sustainability factors?

Yes

No

The Management Company has joined the Net Zero Asset Manager Initiative and considers PAI indicators through stewardship including engagement, both are relevant to mitigate potential adverse impact as a company.

Due to the commitment to the Net Zero Asset Manager Initiative, the Management Company aims to reduce greenhouse gas emissions in partnership with asset owner clients on decarbonisation goals, consistent with an ambition to reach net zero emission by 2050 or sooner across all assets under management. As part of this objective the Management Company will set an interim target for the proportion of assets to be managed in line with the attainment of net zero emissions by 2050 or sooner.

The Sub-Fund's Investment Manager considers PAI indicators regarding greenhouse gas emission, biodiversity, water, waste as well as social and employee matters for corporate issuers, and, where relevant, the freedom house index is applied to investments in sovereigns. PAI indicators are considered within the Investment Manager's investment process through the means of exclusions as described in the "binding elements" section of the Sub-Fund.

The data coverage for the data required for the PAI indicators is heterogenous. The data coverage related to biodiversity, water and waste is low and the related PAI indicators are considered through exclusion of securities issued by companies having a severe violation / breach of principles and guidelines such as the Principles of the United Nations Global Compact, the OECD Guidelines for Multinational Enterprises, and the United Nations Guiding Principles for Business and Human Rights on the grounds of problematic practices around human rights, labour rights, environment, and corruption issues. Therefore, the Investment Manager will strive to increase data coverage for PAI indicators with low data coverage. The Investment Manager will regularly evaluate whether the availability of data has increased sufficiently to potentially include assessment of such data in the investment process.

Additionally, PAI indicators are, among other sustainability factors, applied to derive the SRI Rating. The SRI Rating is used for the portfolio construction.

The following PAI indicators are considered:

Applicable to corporate issuers

- GHG Emissions
- Carbon footprint
- GHG Intensity of investee companies
- Exposure to companies active in the fossil fuel sector
- Activities negatively affecting biodiversity-sensitive areas
- Emissions to water
- Hazardous waste ratio

- Violation of UN Global compact principles
- Lack of processes and compliance mechanisms to monitor compliance with UN Global Compact principles
- Board gender diversity
- Exposure to controversial weapons

Applicable to sovereign and supranational issuers

- Investee countries subject to social violations

The information on the PAI indicators will be available in the end-year report of the Sub-Fund.



The investment strategy guides investment decisions based on factors such as investment objectives and risk tolerance.

What investment strategy does this financial product follow?

Allianz Euro Credit SRI's investment objective is to invest in Investment Grade rated Debt Securities of OECD or EU Bond Markets denominated in EUR in accordance with the Sustainable and Responsible Investment Strategy (SRI Strategy).

As part of the SRI best-in-class approach, the Sub-Fund takes environmental, social, human rights, governance, and business behaviour factors into account as follows:

- The aforesaid sustainability factors are analysed through SRI Research by the Investment Manager in order to assess how sustainable development and long-term issues are taken into account in the strategy of an issuer. SRI Research means the overall process of identifying potential risks as well as potential opportunities of an investment in securities of an issuer related to the analysis of sustainability factors. SRI Research data combines external research data (which might have some limitations) with internal analyses.
- Based on a combination of the results of the external and/or internal analyses of the sustainability factors, an internal rating is derived monthly (SRI Rating) and is afterwards assigned to a corporate or sovereign issuer.

This internal SRI Rating is used to rank and select or weight securities for the portfolio construction.

The Sub-Fund's general investment approach (Sub-Fund's applicable General Asset Class Principles in combination with its individual investment restrictions) is described in the prospectus.

● What are the binding elements of the investment strategy used to select the investments to attain each of the environmental or social characteristics promoted by this financial product?

The binding elements are:

- Minimum rating coverage: At least 90% Sub-Fund's portfolio is required to have an SRI Rating (Portfolio in this respect does not comprise non-rated derivatives and instruments that are non-rated by nature (e.g., cash and deposits). While most holdings of the Sub-Fund's will have a corresponding SRI Rating some investments cannot be rated according to the SRI Research methodology. Examples of instruments not attaining to the SRI Rating include, but are not limited to cash, deposits, Target Funds, and non-rated investments.
- 90% of the rated instruments are adhering to the minimum rating threshold of 2 (out of a rating scale from 0 – 4; 0 being the worst rating and 4 the best rating), and 10% are adhering to a rating threshold between 1,5 and 2.
- Reduction of investment universe by excluding at least 20% of issuers.
- Application of the below sustainable minimum exclusion criteria.

The following sustainable minimum exclusion criteria for direct investments apply:

- securities issued by companies having a severe violation / breach of principles and guidelines such as the Principles of the United Nations Global Compact, the OECD Guidelines for Multinational Enterprises, and the United Nations Guiding Principles for Business and Human Rights on the grounds of problematic practices around human rights, labour rights, environment, and corruption issues,
- securities issued by companies involved in controversial weapons (anti-personnel mines, cluster munitions, chemical weapons, biological weapons, depleted uranium, white phosphorus, and nuclear weapons),
- securities issued by companies that derive more than 10% of their revenues from weapons, military equipment, and services,

- securities issued by companies that derive more than 10% of their revenue from thermal coal extraction,
- securities issued by utility companies that generate more than 20% of their revenues from coal,
- securities issued by companies involved in the production of tobacco, and securities issued by companies involved in the distribution of tobacco with more than 5% of their revenues.

Direct investments in sovereign issuers with an insufficient freedom house index score are excluded.

The sustainable minimum exclusion criteria are based on information from an external data provider and coded in pre- and post-trade compliance. The review is performed at least half yearly.

● **What is the committed minimum rate to reduce the scope of the investments considered prior to the application of that investment strategy?**

The Sub-Fund commits to reduce the investment universe by at least 20%.

● **What is the policy to assess good governance practices of the investee companies?**

Good governance principles are considered by screening out companies based on their involvement in controversies around international norms corresponding to the four good governance practices: sound management structures, employee relations, remuneration of staff and tax compliance. Companies having a severe violation in either of those areas will not be investible. For certain cases, flagged issuers shall be on a watch list. These companies will appear on this watch list when the Investment Manager believes that engagement may lead to improvements or when the company is assessed to take remedial actions. Companies on the watch list remain investible unless the Investment Manager believes that the engagement or the remedial actions of the company does not lead to the desired remedy of the severe controversy.

In addition, the Sub-Fund's Investment Manager is committed to actively encourage open dialogues with investee companies on corporate governance, proxy voting and broader sustainability issues in advance of shareholder meetings (regularly for direct investments in shares). The Sub-Fund's Investment Manager's approach to proxy voting and company engagement is set out in the Management Company's Stewardship Statement.

Good governance practices include sound management structures, employee relations, remuneration of staff and tax compliance.



What is the asset allocation planned for this financial product?

Asset allocation describes the share of investments in specific assets.

Min. 90% of the Sub-Funds' assets (excluding cash and non-rated derivatives) are used to meet the environmental or social characteristics promoted by this Sub-Fund. A low portion of the Sub-Fund might contain assets which do not promote environmental or social characteristics. Examples of such instruments are derivatives, cash and deposits, some Target Funds and investment with temporarily divergent or absent environmental, social, or good governance qualifications. Min. 15% of the Sub-Funds' assets will be invested in Sustainable Investments. The minimum percentage of investments that are aligned with the EU Taxonomy is 0.01%. The Sub-Fund's Investment Manager does not commit to a minimum share of environmentally Sustainable Investments that are not aligned with the EU Taxonomy. The Sub-Fund's Investment Manager does not commit to a minimum share of socially sustainable investments. While the Sub-Fund cannot commit to a minimum share of environmentally or socially sustainable investments, such investments may be freely allocated to within the Sub-Fund aggregated sustainable investment commitment disclosed (min. 15%).

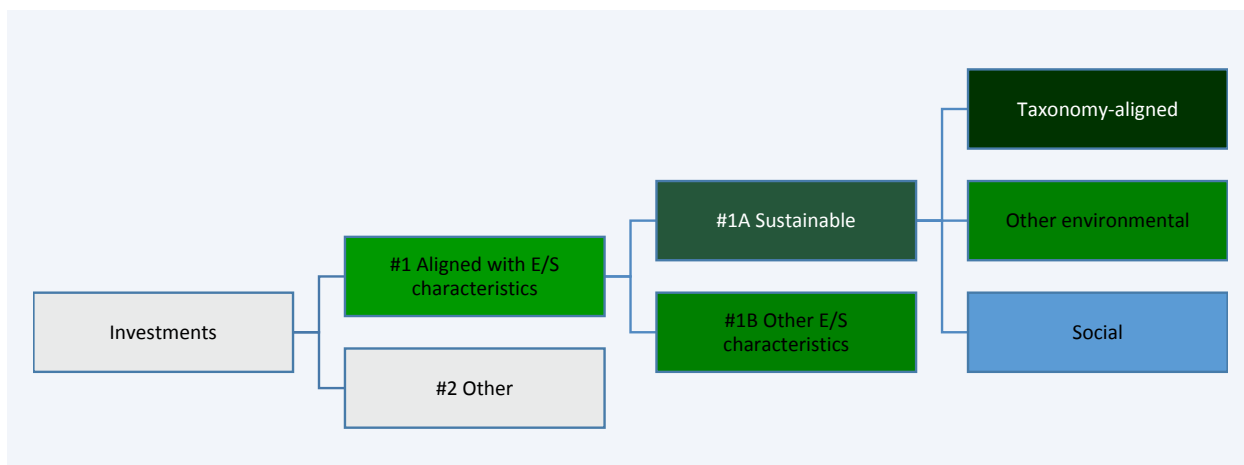

#1 Aligned with E/S characteristics includes the investments of the financial product used to attain the environmental or social characteristics promoted by the financial product.

#2 Other includes the remaining investments of the financial product which are neither aligned with the environmental or social characteristics, nor are qualified as sustainable investments.

The category **#1 Aligned with E/S characteristics** covers:

- The sub-category **#1A Sustainable** covers sustainable investments with environmental or social objectives.
- The sub-category **#1B Other E/S characteristics** covers investments aligned with the environmental or social characteristics that do not qualify as sustainable investments.

- **How does the use of derivatives attain the environmental or social characteristics promoted by the financial product?**

Not applicable



To what minimum extent are sustainable investments with an environmental objective aligned with the EU Taxonomy?

The Taxonomy-aligned investments include debt and/or equity in environmentally sustainable economic activities aligned with the EU-Taxonomy. The minimum percentage of investments that are aligned with the EU Taxonomy is 0.01%. Taxonomy-aligned data is provided by an external data provider. The Investment Manager has assessed the quality of such data. The data will not be subject to an assurance provided by auditors or a review by third parties. The data will not reflect any data in government bonds. As of today, there is no recognized methodology available to determine the proportion of Taxonomy-aligned activities when investing in government bonds.

Taxonomy-aligned activities in this disclosure are based on share of turnover. Pre-contractual figures use turnover as its financial metric as a default in line with the regulatory requirements and based on the fact that complete, verifiable or up-to date data for CAPEX and/or OPEX as financial metric is even less available.

Taxonomy-aligned data is only in rare cases data reported by companies in accordance with the EU Taxonomy. The data provider has derived Taxonomy-aligned data from other available equivalent public data.

- **Does the financial product invest in fossil gas and/or nuclear energy related activities that comply with the EU Taxonomy ¹?**

- Yes:
- In fossil gas In nuclear energy
- No

The Sub-Fund does not pursue any investments in fossil gas and/or nuclear energy related activities that comply with the EU Taxonomy. Nevertheless, as result of this investment strategy, investments may occur in corporates which are also active in these activities. Further information will be provided as part of the annual reporting, if relevant.

Taxonomy-aligned activities are expressed as a share of:

- **turnover** reflecting the share of revenue from green activities of investee companies
- **capital expenditure (CapEx)** showing the green investments made by investee companies, e.g. for a transition to a green

¹ Fossil gas and/or nuclear related activities will only comply with the EU Taxonomy where they contribute to limiting climate change ("climate change mitigation") and do not significantly harm any EU Taxonomy objective - see explanatory note in the left hand margin. The full criteria for fossil gas and nuclear energy economic activities that comply with the EU Taxonomy are laid down in Commission Delegated Regulation (EU) 2022/1214.

economy.
 - **operational expenditure (OpEx)** reflecting green operational activities of investee companies.

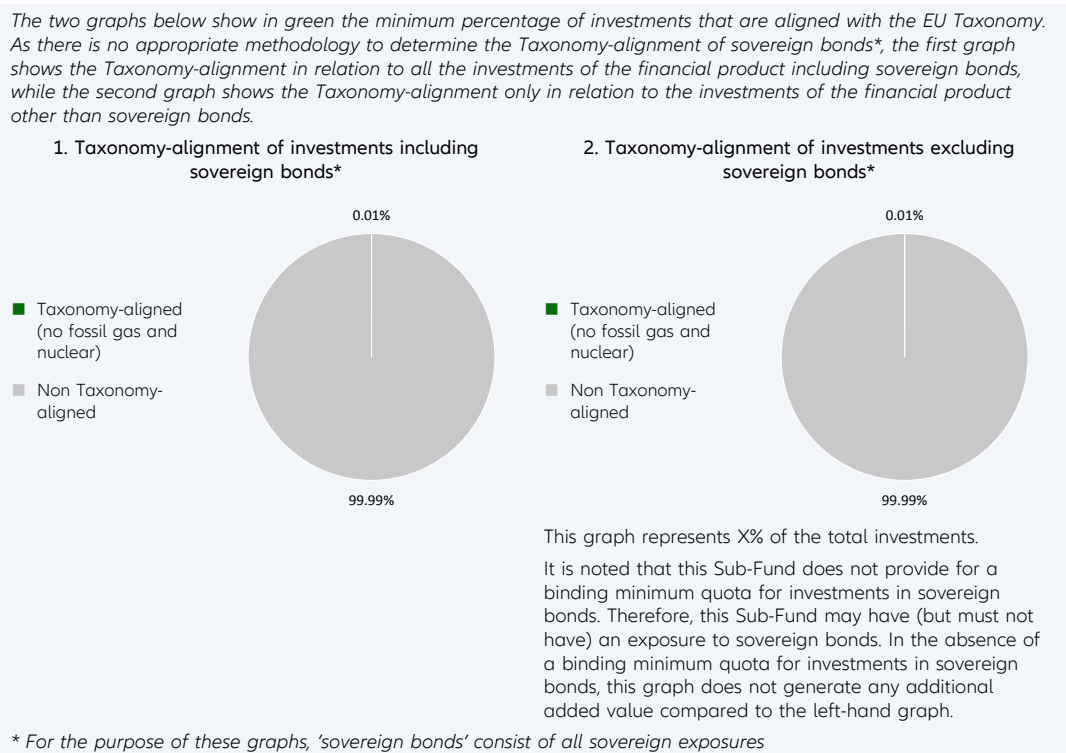

Enabling activities directly enable other activities to make a substantial contribution to an environmental objective.

Transitional activities are activities for which low-carbon alternatives are not yet available and among others have greenhouse gas emission levels corresponding to the best performance.

● **What is the minimum share of investments in transitional and enabling activities?**

The Sub-Fund's Investment Manager does not commit to a split of minimum taxonomy alignment into transitional, enabling activities and own performance.



What is the minimum share of sustainable investments with an environmental objective that are not aligned with the EU Taxonomy?

Taxonomy-aligned investments are considered a sub-category of Sustainable Investments. If an investment is not Taxonomy-aligned since the activity is not yet covered under the EU Taxonomy or the positive contribution is not substantial enough to comply with the Taxonomy technical screening criteria, the investment can still be considered an environmentally Sustainable Investment provided it complies with all criteria. The Investment Manager does not commit to a minimum share of environmentally Sustainable Investments that are not aligned with the EU Taxonomy. The overall sustainable investment share may also include investments with an environmental objective in economic activities that do not qualify as environmentally sustainable under the EU Taxonomy, and while the Sub-Fund cannot commit to a minimum share of environmentally or socially sustainable investments, such investments may be freely allocated to within the Sub-Fund aggregated sustainable investment commitment disclosed (min. 15%).

are sustainable investments with an environmental objective that **do not take into account the criteria** for environmentally sustainable economic activities under the EU Taxonomy.



What is the minimum share of socially sustainable investments?

The Investment Manager defines Sustainable Investments based on internal research, which uses, among others, the UN Sustainable Development Goals (SDGs), as well as the objectives of the EU Taxonomy as reference frameworks. The Investment Manager does not commit to a minimum share of socially Sustainable Investments, as the SDGs contain environmental as well as social objectives. The overall sustainable investment share may also include investments with a social objective, and while the Sub-Fund cannot commit to a minimum share of environmentally or socially sustainable investments, such investments may be freely allocated to within the Sub-Fund aggregated sustainable investment commitment disclosed (min. 15%).



What investments are included under “#2 Other”, what is their purpose and are there any minimum environmental or social safeguards?

Under “#2 Other” investments into cash, Target Funds, or derivatives can be included. Derivatives might be used for efficient portfolio management (including risk hedging) and/or investment purposes, and Target Funds to benefit from a specific strategy. For those investments no environmental or social safeguards are applied.



Is a specific index designated as a reference benchmark to determine whether this financial product is aligned with the environmental and/or social characteristics that it promotes?

No reference benchmark has been designated for the purpose of attaining the environmental and/or social characteristics promoted by the Sub-Fund.

- How is the reference benchmark continuously aligned with each of the environmental or social characteristics promoted by the financial product?

Not applicable

- How is the alignment of the investment strategy with the methodology of the index ensured on a continuous basis?

Not applicable

- How does the designated index differ from a relevant broad market index?

Not applicable

- Where can the methodology used for the calculation of the designated index be found?

Not applicable



Where can I find more product specific information online?

More product-specific information can be found on the website: <https://regulatory.allianzgi.com/SFDR>

Reference benchmarks are indexes to measure whether the financial product attains the environmental or social characteristics that they promote.

Template pre-contractual disclosure for the financial products referred to in Article 8, paragraphs 1, 2 and 2a, of Regulation (EU) 2019/2088 and Article 6, first paragraph, of Regulation (EU) 2020/852

Product name:

Allianz Euro Government Bond

Legal entity identifier: 529900Z9QTQFM4SHJL76

Environmental and/or social characteristics

Sustainable investment means an investment in an economic activity that contributes to an environmental or social objective, provided that the investment does not significantly harm any environmental or social objective and that the investee companies follow good governance practices.

The **EU Taxonomy** is a classification system laid down in Regulation (EU) 2020/852, establishing a list of **environmentally sustainable economic activities**. That Regulation does not include a list of socially sustainable economic activities. Sustainable investments with an environmental objective might be aligned with the Taxonomy or not.

Does this financial product have a sustainable investment objective?

Yes

No

It will make a minimum of **sustainable investments with an environmental objective**: ____%

in economic activities that qualify as environmentally sustainable under the EU Taxonomy

in economic activities that do not qualify as environmentally sustainable under the EU Taxonomy

It will make a minimum of **sustainable investments with a social objective** ____%

It **promotes Environmental/Social (E/S) characteristics** and while it does not have as its objective a sustainable investment, it will have a minimum proportion of **1.00%** of sustainable investments

with an environmental objective in economic activities that qualify as environmentally sustainable under the EU Taxonomy

with an environmental objective in economic activities that do not qualify as environmentally sustainable under the EU Taxonomy

with a social objective

It promotes E/S characteristics, but **will not make any sustainable investments**



What environmental and/or social characteristics are promoted by this financial product?

Allianz Euro Government Bond (the "Sub-Fund") promotes environmental, social, human rights, governance, and business behaviour factors (this domain does not apply for sovereigns issued by a Sovereign Entity) through integration of a best-in-class approach into the Sub-Fund's investment process. This encompasses the evaluation of corporate or sovereign issuers based on an SRI Rating which is used to construct the portfolio.

In addition, sustainable minimum exclusion criteria apply.

No reference benchmark has been designated for the purpose of attaining the environmental and/or social characteristics promoted by the Sub-Fund.

● What sustainability indicators are used to measure the attainment of each of the environmental or social characteristics promoted by this financial product?

To measure the attainment of the environmental and/or social characteristics the following sustainability indicators are used and reported on, at the fiscal year end:

- The actual percentage of the Sub-Fund's Portfolio (Portfolio in this respect does not comprise non-rated derivatives and instruments that are non-rated by nature (e. g., cash and deposits)) assets invested in best-in-class issuers (issuers with a minimum SRI Rating of 2 out of a scale from 0-4; 0 being the worst rating and 4 the best rating) is compared to the actual percentage of the benchmarks best-in-class issuers.
- Confirmation that Principal Adverse Impacts (PAIs) of investment decisions on sustainability factors are considered through the application of exclusion criteria.

Sustainability indicators measure how the environmental or social characteristics promoted by the financial product are attained.

- **What are the objectives of the sustainable investments that the financial product partially intends to make and how does the sustainable investment contribute to such objectives?**

Sustainable investments contribute to environmental and/or social objectives, for which the Investment Manager uses as reference frameworks, among others, the UN Sustainable Development Goals (SDGs), as well as the objectives of the EU Taxonomy:

1. Climate Change Mitigation
2. Climate Change Adaptation
3. Sustainable Use and Protection of Water and Marine Resources
4. Transition to a Circular Economy
5. Pollution Prevention and Control
6. Protection and Restoration of Biodiversity and Ecosystems

The assessment of the positive contribution to the environmental or social objectives is based on a proprietary framework which combines quantitative elements with qualitative inputs from internal research. The methodology applies first a quantitative breakdown of a securities issuer into its business activities. The qualitative element of the framework is an assessment if business activities contribute positively to an environmental or a social objective.

To calculate the positive contribution on the Sub-Fund level the revenue share of each issuer attributable to business activities contributing to environmental and/or social objectives is considered provided the issuer is satisfying the Do No Significant Harm (“DNSH”) and Good Governance principles, and an asset-weighted aggregation is performed as a second step. Moreover, for certain types of securities, which finance specific projects contributing to environmental or social objectives the overall investment is considered to contribute to environmental and/or social objectives, but also for these a DNSH as well as a Good Governance check for issuers is performed.

- **How do the sustainable investments that the financial product partially intends to make, not cause significant harm to any environmental or social sustainable investment objective?**

In order to ensure that Sustainable Investments do not significantly harm any other environmental and/or social objective, the Investment Manager is leveraging the PAI indicators, whereby significance thresholds have been defined to identify significantly harmful issuers. Issuers not meeting the significance threshold can be engaged for a limited time period to remediate the adverse impact. Otherwise, if the issuer does not meet the defined significance thresholds twice subsequently or in case of a failed engagement, it does not pass the DNSH assessment. Investments in securities of issuers which do not pass the DNSH assessment are not counted as sustainable investments.

- *How have the indicators for adverse impacts on sustainability factors been taken into account?*

All mandatory PAI indicators are considered either as part of the application of the exclusion criteria or through thresholds on a sectorial or absolute basis. Significance thresholds have been defined and they refer to qualitative or quantitative criteria.

Recognizing the lack of data coverage for some of the PAI indicators equivalent data points are used to assess PAI indicators when applying the DNSH assessment, when relevant, for the following indicators for corporates: share of non-renewable energy consumption and production, activities negatively affecting biodiversity-sensitive areas, emissions to water, lack of processes and compliance mechanisms to monitor compliance with UNGC principles and OECD Guidelines for Multinational Enterprises; for sovereigns: GHG Intensity and investee countries subject to social violations. In case of securities which finance specific projects contributing to environmental or social objectives equivalent data at project level might be used to ensure that Sustainable Investments do not significantly harm any other environmental and/or social objective. The Investment Manager will strive to increase data coverage for PAI indicators with low data coverage by engaging with issuers and data providers. The Investment Manager will regularly evaluate whether the availability of data has increased sufficiently to potentially include assessment of such data in the investment process.

- *How are the sustainable investments aligned with the OECD Guidelines for Multinational Enterprises and the UN Guiding Principles on Business and Human Rights? Details:*

The Investment Manager’s sustainable minimum exclusion list screens out companies based on their involvement in controversial practices against international norms. The core normative framework consists of the Principles of the UN Global Compact, the OECD Guidelines for Multinational Enterprises

Principal adverse impacts are the most significant negative impacts of investment decisions on sustainability factors relating to environmental, social and employee matters, respect for human rights, anti-corruption and anti-bribery matters.

and the UN Guiding Principles for Business and Human Rights. Securities issued by companies having a severe violation of these frameworks will be restricted from the investment universe.

The EU Taxonomy sets out a “do not significant harm” principle by which Taxonomy-aligned investments should not significantly harm EU Taxonomy objectives and is accompanied by specific EU criteria.

The “do not significant harm” principle applies only to those investments underlying the financial product that take into account the EU criteria for environmentally sustainable economic activities. The investments underlying the remaining portion of this financial product do not take into account the EU criteria for environmentally sustainable economic activities.

Any other sustainable investments must also not significantly harm any environmental or social objectives.



Does this financial product consider principal adverse impacts on sustainability factors?

Yes

No

The Management Company has joined the Net Zero Asset Manager Initiative and considers PAI indicators through stewardship including engagement, both are relevant to mitigate potential adverse impact as a company.

Due to the commitment to the Net Zero Asset Manager Initiative, the Management Company aims to reduce greenhouse gas emissions in partnership with asset owner clients on decarbonisation goals, consistent with an ambition to reach net zero emission by 2050 or sooner across all assets under management. As part of this objective the Management Company will set an interim target for the proportion of assets to be managed in line with the attainment of net zero emissions by 2050 or sooner.

The Sub-Fund’s Investment Manager considers PAI indicators regarding greenhouse gas emission, biodiversity, water, waste as well as social and employee matters for corporate issuers, and, where relevant, the freedom house index is applied to investments in sovereigns. PAI indicators are considered within the Investment Manager’s investment process through the means of exclusions as described in the “binding elements” section of the Sub-Fund.

The data coverage for the data required for the PAI indicators is heterogenous. The data coverage related to biodiversity, water and waste is low and the related PAI indicators are considered through exclusion of securities issued by companies having a severe violation / breach of principles and guidelines such as the Principles of the United Nations Global Compact, the OECD Guidelines for Multinational Enterprises, and the United Nations Guiding Principles for Business and Human Rights on the grounds of problematic practices around human rights, labour rights, environment, and corruption issues. Therefore, the Investment Manager will strive to increase data coverage for PAI indicators with low data coverage. The Investment Manager will regularly evaluate whether the availability of data has increased sufficiently to potentially include assessment of such data in the investment process.

Additionally, PAI indicators are, among other sustainability factors, applied to derive the SRI Rating. The SRI Rating is used for the portfolio construction.

The following PAI indicators are considered:

Applicable to corporate issuers

- GHG Emissions
- Carbon footprint
- GHG Intensity of investee companies
- Exposure to companies active in the fossil fuel sector
- Activities negatively affecting biodiversity-sensitive areas
- Emissions to water
- Hazardous waste ratio
- Violation of UN Global compact principles
- Lack of processes and compliance mechanisms to monitor compliance with UN Global Compact principles
- Board gender diversity
- Exposure to controversial weapons

Applicable to sovereign and supranational issuers

- Investee countries subject to social violations

The information on the PAI indicators will be available in the end-year report of the Sub-Fund.



The investment strategy guides investment decisions based on factors such as investment objectives and risk tolerance.

What investment strategy does this financial product follow?

Allianz Euro Government Bond's investment objective is to invest in government Debt Securities of the Eurozone Bond Markets in accordance with the Sustainable and Responsible Investment Strategy (SRI Strategy).

As part of the SRI best-in-class approach, the Sub-Fund takes environmental, social, human rights, governance, and business behaviour factors into account as follows:

- The aforesaid sustainability factors are analysed through SRI Research by the Investment Manager in order to assess how sustainable development and long-term issues are taken into account in the strategy of an issuer. SRI Research means the overall process of identifying potential risks as well as potential opportunities of an investment in securities of an issuer related to the analysis of sustainability factors. SRI Research data combines external research data (which might have some limitations) with internal analyses.
- Based on a combination of the results of the external and/or internal analyses of the sustainability factors, an internal rating is derived monthly (SRI Rating) and is afterwards assigned to a corporate or sovereign issuer.

This internal SRI Rating is used to rank and select or weight securities for the portfolio construction.

The Sub-Fund's general investment approach (Sub-Fund's applicable General Asset Class Principles in combination with its individual investment restrictions) is described in the prospectus.

● What are the binding elements of the investment strategy used to select the investments to attain each of the environmental or social characteristics promoted by this financial product?

The binding elements are:

- Minimum rating coverage: At least 90% of the Sub-Fund's portfolio is required to have an SRI Rating (portfolio in this respect does not comprise non-rated derivatives and instruments that are non-rated by nature e.g., cash and deposits). While most holdings of the Sub-Fund will have a corresponding SRI Rating some investments cannot be rated according to the SRI Research methodology. Examples of instruments not attaining to the SRI Rating include, but are not limited to cash, deposits, Target Funds, and non-rated investments.
- The rated instruments are adhering to the minimum rating threshold of 2 (out of a rating scale from 0 – 4; 0 being the worst rating and 4 the best rating).
- Application of the following sustainable minimum exclusion criteria for direct investments:
 - securities issued by companies having a severe violation / breach of principles and guidelines such as the Principles of the United Nations Global Compact, the OECD Guidelines for Multinational Enterprises, and the United Nations Guiding Principles for Business and Human Rights on the grounds of problematic practices around human rights, labour rights, environment, and corruption issues,
 - securities issued by companies involved in controversial weapons (anti-personnel mines, cluster munitions, chemical weapons, biological weapons, depleted uranium, white phosphorus, and nuclear weapons),
 - securities issued by companies that derive more than 10% of their revenues from weapons, military equipment, and services,
 - securities issued by companies that derive more than 10% of their revenue from thermal coal extraction,
 - securities issued by utility companies that generate more than 20% of their revenues from coal,
 - securities issued by companies involved in the production of tobacco, and securities issued by companies involved in the distribution of tobacco with more than 5% of their revenues.

Direct investments in sovereign issuers with an insufficient freedom house index score are excluded.

The sustainable minimum exclusion criteria are based on information from an external data provider and coded in pre- and post-trade compliance. The review is performed at least half yearly.

- **What is the committed minimum rate to reduce the scope of the investments considered prior to the application of that investment strategy?**

The Sub-Fund does not commit to reduce the scope of the investments by a certain minimum rate.

- **What is the policy to assess good governance practices of the investee companies?**

Good governance principles are considered by screening out companies based on their involvement in controversies around international norms corresponding to the four good governance practices: sound management structures, employee relations, remuneration of staff and tax compliance. Companies having a severe violation in either of those areas will not be investible. For certain cases, flagged issuers shall be on a watch list. These companies will appear on this watch list when the Investment Manager believes that engagement may lead to improvements or when the company is assessed to take remedial actions. Companies on the watch list remain investible unless the Investment Manager believes that the engagement or the remedial actions of the company does not lead to the desired remedy of the severe controversy.

In addition, the Sub-Fund's Investment Manager is committed to actively encourage open dialogues with investee companies on corporate governance, proxy voting and broader sustainability issues in advance of shareholder meetings (regularly for direct investments in shares). The Sub-Fund's Investment Manager's approach to proxy voting and company engagement is set out in the Management Company's Stewardship Statement.

Good governance practices include sound management structures, employee relations, remuneration of staff and tax compliance.



What is the asset allocation planned for this financial product?

Asset allocation describes the share of investments in specific assets.

Min. 90% of the Sub-Funds' assets (excluding cash and non-rated derivatives) are used to meet the environmental or social characteristics promoted by this Sub-Fund. A low portion of the Sub-Fund might contain assets which do not promote environmental or social characteristics. Examples of such instruments are derivatives, cash and deposits, some Target Funds and investment with temporarily divergent or absent environmental, social, or good governance qualifications. Min. 1% of the Sub-Funds' assets will be invested in Sustainable Investments. The Sub-Fund's Investment Manager does not commit to a minimum share of sustainable investments with an environmental objective aligned with the EU Taxonomy nor to a minimum share of environmentally Sustainable Investments that are not aligned with the EU Taxonomy. The Sub-Fund's Investment Manager does not commit to a minimum share of socially sustainable investments. While the Sub-Fund cannot commit to a minimum share of environmentally or socially sustainable investments, such investments may be freely allocated to within the Sub-Fund aggregated sustainable investment commitment disclosed (min. 1%).

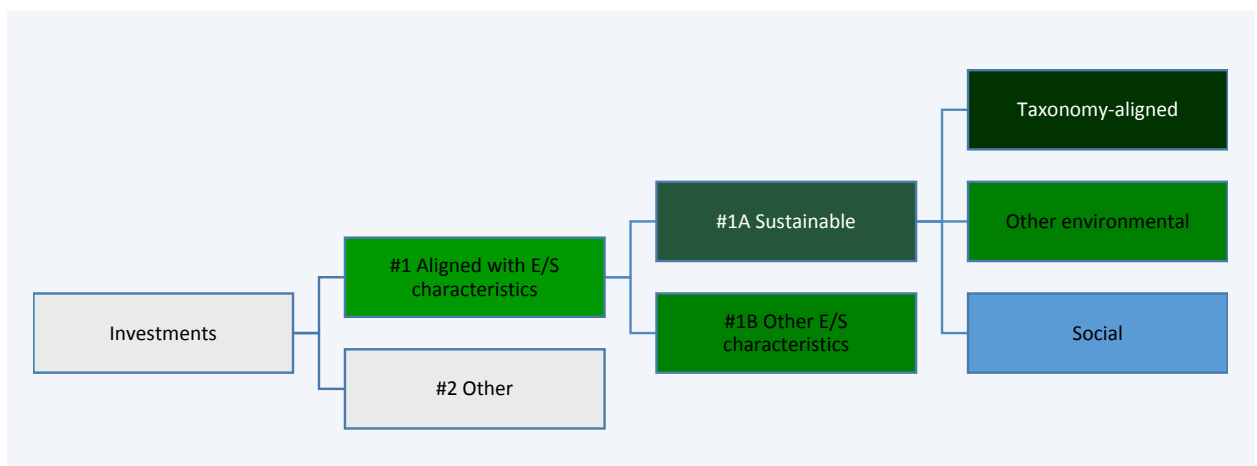

#1 Aligned with E/S characteristics includes the investments of the financial product used to attain the environmental or social characteristics promoted by the financial product.

#2 Other includes the remaining investments of the financial product which are neither aligned with the environmental or social characteristics, nor are qualified as sustainable investments.

The category **#1 Aligned with E/S characteristics** covers:

- The sub-category **#1A Sustainable** covers sustainable investments with environmental or social objectives.
- The sub-category **#1B Other E/S characteristics** covers investments aligned with the environmental or social characteristics that do not qualify as sustainable investments.

- How does the use of derivatives attain the environmental or social characteristics promoted by the financial product?

Not applicable



To what minimum extent are sustainable investments with an environmental objective aligned with the EU Taxonomy?

The Sub-Fund's Investment Manager does not commit to a minimum share of sustainable investments with an environmental objective aligned with the EU Taxonomy. The overall sustainable investment share may also include investments with an environmental objective in economic activities that qualify as environmentally sustainable under the EU Taxonomy.

- Does the financial product invest in fossil gas and/or nuclear energy related activities that comply with the EU Taxonomy ¹?

- Yes:
- In fossil gas In nuclear energy
- No

The Sub-Fund does not pursue any investments in fossil gas and/or nuclear energy related activities that comply with the EU Taxonomy. Nevertheless, as result of this investment strategy, investments may occur in corporates which are also active in these activities. Further information will be provided as part of the annual reporting, if relevant.

The two graphs below show in green the minimum percentage of investments that are aligned with the EU Taxonomy. As there is no appropriate methodology to determine the Taxonomy-alignment of sovereign bonds*, the first graph shows the Taxonomy-alignment in relation to all the investments of the financial product including sovereign bonds, while the second graph shows the Taxonomy-alignment only in relation to the investments of the financial product other than sovereign bonds.

1. Taxonomy-alignment of investments including sovereign bonds*

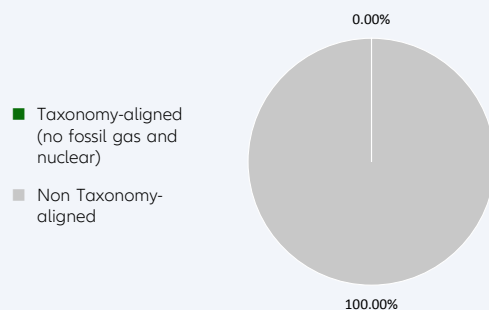

2. Taxonomy-alignment of investments excluding sovereign bonds*

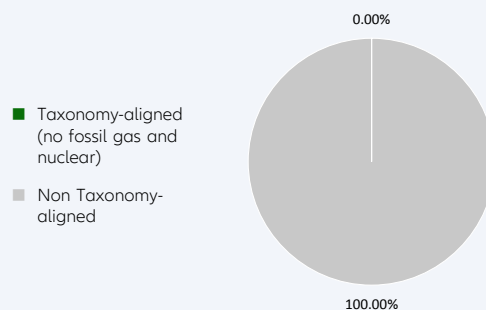

This graph represents X% of the total investments. It is noted that – due to the fact that this Sub-Fund does not provide for a minimum quota of taxonomy-aligned investments – this graph does not generate any additional added value compared to the left-hand graph.

* For the purpose of these graphs, 'sovereign bonds' consist of all sovereign exposures

- What is the minimum share of investments in transitional and enabling activities?

The Sub-Fund's Investment Manager does not commit to a split of minimum taxonomy alignment into transitional, enabling activities and own performance.

Taxonomy-aligned activities are expressed as a share of:

- **turnover** reflecting the share of revenue from green activities of investee companies
- **capital expenditure** (CapEx) showing the green investments made by investee companies, e.g. for a transition to a green economy.
- **operational expenditure** (OpEx) reflecting green operational activities of investee companies.

Enabling activities directly enable other activities to make a substantial contribution to an environmental objective.

Transitional activities are activities for which low-carbon alternatives are not yet available

¹ Fossil gas and/or nuclear related activities will only comply with the EU Taxonomy where they contribute to limiting climate change ("climate change mitigation") and do not significantly harm any EU Taxonomy objective - see explanatory note in the left hand margin. The full criteria for fossil gas and nuclear energy economic activities that comply with the EU Taxonomy are laid down in Commission Delegated Regulation (EU) 2022/1214.

and among others have greenhouse gas emission levels corresponding to the best performance.



What is the minimum share of sustainable investments with an environmental objective that are not aligned with the EU Taxonomy?

Taxonomy-aligned investments are considered a sub-category of Sustainable Investments. If an investment is not Taxonomy-aligned since the activity is not yet covered under the EU Taxonomy or the positive contribution is not substantial enough to comply with the Taxonomy technical screening criteria, the investment can still be considered an environmentally Sustainable Investment provided it complies with all criteria. The Investment Manager does not commit to a minimum share of environmentally Sustainable Investments that are not aligned with the EU Taxonomy. The overall sustainable investment share may also include investments with an environmental objective in economic activities that do not qualify as environmentally sustainable under the EU Taxonomy, and while the Sub-Fund cannot commit to a minimum share of environmentally or socially sustainable investments, such investments may be freely allocated to within the Sub-Fund aggregated sustainable investment commitment disclosed (min. 1%).



are sustainable investments with an environmental objective that **do not take into account the criteria** for environmentally sustainable economic activities under the EU Taxonomy.



What is the minimum share of socially sustainable investments?

The Investment Manager defines Sustainable Investments based on internal research, which uses, among others, the UN Sustainable Development Goals (SDGs), as well as the objectives of the EU Taxonomy as reference frameworks. The Investment Manager does not commit to a minimum share of socially Sustainable Investments, as the SDGs contain environmental as well as social objectives. The overall sustainable investment share may also include investments with a social objective, and while the Sub-Fund cannot commit to a minimum share of environmentally or socially sustainable investments, such investments may be freely allocated to within the Sub-Fund aggregated sustainable investment commitment disclosed (min. 1%).



What investments are included under “#2 Other”, what is their purpose and are there any minimum environmental or social safeguards?

Under “#2 Other” investments into cash, Target Funds, or derivatives can be included. Derivatives might be used for efficient portfolio management (including risk hedging) and/or investment purposes, and Target Funds to benefit from a specific strategy. For those investments no environmental or social safeguards are applied.



Is a specific index designated as a reference benchmark to determine whether this financial product is aligned with the environmental and/or social characteristics that it promotes?

No reference benchmark has been designated for the purpose of attaining the environmental and/or social characteristics promoted by the Sub-Fund.

Reference benchmarks are indexes to measure whether the financial product attains the environmental or social characteristics that they promote.

- How is the reference benchmark continuously aligned with each of the environmental or social characteristics promoted by the financial product?

Not applicable

- How is the alignment of the investment strategy with the methodology of the index ensured on a continuous basis?

Not applicable

- How does the designated index differ from a relevant broad market index?
Not applicable
- Where can the methodology used for the calculation of the designated index be found?
Not applicable



Where can I find more product specific information online?

More product-specific information can be found on the website: <https://regulatory.allianzgi.com/SFDR>

Template pre-contractual disclosure for the financial products referred to in Article 8, paragraphs 1, 2 and 2a, of Regulation (EU) 2019/2088 and Article 6, first paragraph, of Regulation (EU) 2020/852

Product name:

Allianz Euro High Yield Bond

Legal entity identifier: IS7IKH6HMU9CTMM3VM48

Environmental and/or social characteristics

Sustainable investment means an investment in an economic activity that contributes to an environmental or social objective, provided that the investment does not significantly harm any environmental or social objective and that the investee companies follow good governance practices.

The EU Taxonomy is a classification system laid down in Regulation (EU) 2020/852, establishing a list of **environmentally sustainable economic activities**. That Regulation does not include a list of socially sustainable economic activities. Sustainable investments with an environmental objective might be aligned with the Taxonomy or not.

Does this financial product have a sustainable investment objective?

Yes

No

It will make a minimum of **sustainable investments with an environmental objective**: ___%

in economic activities that qualify as environmentally sustainable under the EU Taxonomy

in economic activities that do not qualify as environmentally sustainable under the EU Taxonomy

It will make a minimum of **sustainable investments with a social objective** ___%

It promotes **Environmental/Social (E/S) characteristics** and while it does not have as its objective a sustainable investment, it will have a minimum proportion of **5.00%** of sustainable investments

with an environmental objective in economic activities that qualify as environmentally sustainable under the EU Taxonomy

with an environmental objective in economic activities that do not qualify as environmentally sustainable under the EU Taxonomy

with a social objective

It promotes E/S characteristics, but **will not make any sustainable investments**



What environmental and/or social characteristics are promoted by this financial product?

Allianz Euro High Yield Bond (the "Sub-Fund") is managed according to the Sustainability Key Performance Indicator Strategy (Relative) ("KPI Strategy (Relative)") which addresses greenhouse gas (GHG) Intensity. The "Sustainability KPI" measures the GHG Intensity defined by the weighted average intensity of greenhouse gas emissions based on company's annual sales ("GHG Intensity").

GHG Intensity will be addressed by outperforming the Weighted Average GHG Intensity against its benchmark.

In addition, sustainable minimum exclusion criteria apply.

A reference benchmark has been designated for the purpose of attaining the environmental and/or social characteristics promoted by the Sub-Fund.

● What sustainability indicators are used to measure the attainment of each of the environmental or social characteristics promoted by this financial product?

To measure the attainment of the environmental and/or social characteristics the following sustainability indicators are used and reported on, at the fiscal year end:

- The actual percentage of KPI coverage of the Sub-Fund's Portfolio (Portfolio in this respect does not comprise derivatives and instruments that are non-evaluated by nature (e. g., cash and deposits)).
- The actual weighted average GHG Intensity portfolio vs weighted average GHG Intensity of the benchmark.

Sustainability indicators measure how the environmental or social characteristics promoted by the financial product are attained.

- Confirmation that Principal Adverse Impacts (PAIs) of investment decisions on sustainability factors are considered through the application of exclusion criteria.

- **What are the objectives of the sustainable investments that the financial product partially intends to make and how does the sustainable investment contribute to such objectives?**

Sustainable investments contribute to environmental and/or social objectives, for which the Investment Manager uses as reference frameworks, among others, the UN Sustainable Development Goals (SDGs), as well as the objectives of the EU Taxonomy:

1. Climate Change Mitigation
2. Climate Change Adaptation
3. Sustainable Use and Protection of Water and Marine Resources
4. Transition to a Circular Economy
5. Pollution Prevention and Control
6. Protection and Restoration of Biodiversity and Ecosystems

The assessment of the positive contribution to the environmental or social objectives is based on a proprietary framework which combines quantitative elements with qualitative inputs from internal research. The methodology applies first a quantitative breakdown of a securities issuer into its business activities. The qualitative element of the framework is an assessment if business activities contribute positively to an environmental or a social objective.

To calculate the positive contribution on the Sub-Fund level the revenue share of each issuer attributable to business activities contributing to environmental and/or social objectives is considered provided the issuer is satisfying the Do No Significant Harm (“DNSH”) and Good Governance principles, and an asset-weighted aggregation is performed as a second step. Moreover, for certain types of securities, which finance specific projects contributing to environmental or social objectives the overall investment is considered to contribute to environmental and/or social objectives, but also for these a DNSH as well as a Good Governance check for issuers is performed.

- **How do the sustainable investments that the financial product partially intends to make, not cause significant harm to any environmental or social sustainable investment objective?**

In order to ensure that Sustainable Investments do not significantly harm any other environmental and/or social objective, the Investment Manager is leveraging the PAI indicators, whereby significance thresholds have been defined to identify significantly harmful issuers. Issuers not meeting the significance threshold can be engaged for a limited time period to remediate the adverse impact. Otherwise, if the issuer does not meet the defined significance thresholds twice subsequently or in case of a failed engagement, it does not pass the DNSH assessment. Investments in securities of issuers which do not pass the DNSH assessment are not counted as sustainable investments.

- *How have the indicators for adverse impacts on sustainability factors been taken into account?*

All mandatory PAI indicators are considered either as part of the application of the exclusion criteria or through thresholds on a sectorial or absolute basis. Significance thresholds have been defined and they refer to qualitative or quantitative criteria.

Recognizing the lack of data coverage for some of the PAI indicators equivalent data points are used to assess PAI indicators when applying the DNSH assessment, when relevant, for the following indicators for corporates: share of non-renewable energy consumption and production, activities negatively affecting biodiversity-sensitive areas, emissions to water, lack of processes and compliance mechanisms to monitor compliance with UNGC principles and OECD Guidelines for Multinational Enterprises; for sovereigns: GHG Intensity and investee countries subject to social violations. In case of securities which finance specific projects contributing to environmental or social objectives equivalent data at project level might be used to ensure that Sustainable Investments do not significantly harm any other environmental and/or social objective. The Investment Manager will strive to increase data coverage for PAI indicators with low data coverage by engaging with issuers and data providers. The Investment Manager will regularly evaluate whether the availability of data has increased sufficiently to potentially include assessment of such data in the investment process.

Principal adverse impacts are the most significant negative impacts of investment decisions on sustainability factors relating to environmental, social and employee matters, respect for human rights, anti-corruption and anti-bribery matters.

- *How are the sustainable investments aligned with the OECD Guidelines for Multinational Enterprises and the UN Guiding Principles on Business and Human Rights? Details:*

The Investment Manager's sustainable minimum exclusion list screens out companies based on their involvement in controversial practices against international norms. The core normative framework consists of the Principles of the UN Global Compact, the OECD Guidelines for Multinational Enterprises and the UN Guiding Principles for Business and Human Rights. Securities issued by companies having a severe violation of these frameworks will be restricted from the investment universe.

The EU Taxonomy sets out a "do not significant harm" principle by which Taxonomy-aligned investments should not significantly harm EU Taxonomy objectives and is accompanied by specific EU criteria.

The "do not significant harm" principle applies only to those investments underlying the financial product that take into account the EU criteria for environmentally sustainable economic activities. The investments underlying the remaining portion of this financial product do not take into account the EU criteria for environmentally sustainable economic activities.

Any other sustainable investments must also not significantly harm any environmental or social objectives.



Does this financial product consider principal adverse impacts on sustainability factors?

Yes

No

The Management Company has joined the Net Zero Asset Manager Initiative and considers PAI indicators through stewardship including engagement, both are relevant to mitigate potential adverse impact as a company.

Due to the commitment to the Net Zero Asset Manager Initiative, the Management Company aims to reduce greenhouse gas emissions in partnership with asset owner clients on decarbonisation goals, consistent with an ambition to reach net zero emission by 2050 or sooner across all assets under management. As part of this objective the Management Company will set an interim target for the proportion of assets to be managed in line with the attainment of net zero emissions by 2050 or sooner.

The Sub-Fund's Investment Manager addresses PAI indicators regarding greenhouse gas emission, biodiversity, water, waste as well as social and employee matters for corporate issuers, and, where relevant, the freedom house index is applied to investments in sovereigns. PAI indicators are considered within the Investment Manager's investment process through the means of exclusions as described in the "binding elements" section of the Sub-Fund.

The data coverage for the data required for the PAI indicators is heterogenous. The data coverage related to biodiversity, water and waste is low and the related PAI indicators are considered through exclusion of securities issued by companies having a severe violation / breach of principles and guidelines such as the Principles of the United Nations Global Compact, the OECD Guidelines for Multinational Enterprises, and the United Nations Guiding Principles for Business and Human Rights on the grounds of problematic practices around human rights, labour rights, environment, and corruption issues. Therefore, the Investment Manager will strive to increase data coverage for PAI indicators with low data coverage. The Investment Manager will regularly evaluate whether the availability of data has increased sufficiently to potentially include assessment of such data in the investment process.

Additionally, the Investment manager considers GHG related PAI indicators by outperforming the Weighted Average GHG Intensity against its benchmark. The following PAI indicators are considered:

Applicable to corporate issuers

- GHG Emissions
- Carbon footprint
- GHG Intensity of investee companies
- Exposure to companies active in the fossil fuel sector
- Activities negatively affecting biodiversity-sensitive areas
- Emissions to water
- Hazardous waste ratio
- Violation of UN Global compact principles

- Lack of processes and compliance mechanisms to monitor compliance with UN Global Compact principles
- Board gender diversity
- Exposure to controversial weapons

Applicable to sovereign and supranational issuers

- Investee countries subject to social violations

The information on the PAI indicators will be available in the end-year report of the Sub-Fund.



What investment strategy does this financial product follow?

The investment strategy guides investment decisions based on factors such as investment objectives and risk tolerance.

Allianz Euro High Yield Bond's investment objective is to invest in high yield rated Debt Securities denominated in EUR in accordance with the Sustainability Key Performance Indicator Strategy (Relative) ("KPI Strategy (Relative)").

The Sub-Fund's strategy is to outperform the Weighted Average GHG Intensity against its benchmark. The outperformance is determined as the excess between the Sub-Fund's weighted average GHG Intensity and the Sub-Fund's benchmark Weighted Average GHG Intensity.

The weighted average GHG Intensity is the weighted average of the Sub-Fund's GHG Intensity (in tCO₂e per Millions of sales). Sales represent company's annual sales. This ratio of GHG normalized by Sales facilitates comparison between companies of different sizes. The ratio is in tCO₂e per Millions of sales. The metric allows comparing weighted average GHG Intensities of different portfolios to identify portfolios comprised of more GHG-efficient issuers in terms of the issuer's sales. The portfolio weights (and benchmark or universe weights) are rebased such that only issuers with GHG emissions data available are considered in the calculation. GHG represents a respective issuer's greenhouse gas emissions. To determine the GHG Intensity of a company issuer, GHG Intensity data from third party data providers will be used. The GHG intensity is analysed by the Investment Manager and is considered within the securities selection process in order to meet the Sub-Fund Investment objective.

The proportion of assets which do not have a GHG intensity assessment is expected to be low. Examples of instruments not having a GHG intensity assessment are cash and deposits, some Target Funds, and investments for which the GHG intensity is deemed to be not appropriate and/or data is not available.

The Sub-Fund's general investment approach (Sub-Fund's applicable General Asset Class Principles in combination with its individual investment restrictions) is described in the prospectus.

● What are the binding elements of the investment strategy used to select the investments to attain each of the environmental or social characteristics promoted by this financial product?

The binding elements are:

- Min. 70% KPI coverage of the Sub-Fund's Portfolio (Portfolio in this respect does not comprise derivatives and instruments that are non-evaluated by nature (e. g., cash and deposits)).
- Min. 20% outperformance of benchmark in terms of Weighted Average GHG Intensity.
- Application of the following sustainable minimum exclusion criteria for direct investments:
 - securities issued by companies having a severe violation / breach of principles and guidelines such as the Principles of the United Nations Global Compact, the OECD Guidelines for Multinational Enterprises, and the United Nations Guiding Principles for Business and Human Rights on the grounds of problematic practices around human rights, labour rights, environment, and corruption,
 - securities issued by companies involved in controversial weapons (anti-personnel mines, cluster munitions, chemical weapons, biological weapons, depleted uranium, white phosphorus, and nuclear weapons),
 - securities issued by companies that derive more than 10% of their revenues from weapons, military equipment, and services,
 - securities issued by companies that derive more than 10% of their revenue from thermal coal extraction
 - securities issued by utility companies that generate more than 20% of their revenues from coal,
 - securities issued by companies involved in the production of tobacco, and securities issued by companies involved in the distribution of tobacco with more than 5% of their revenues.

Direct investments in sovereign issuers with an insufficient freedom house index score are excluded.

The sustainable minimum exclusion criteria are based on information from an external data provider and coded in pre- and post-trade compliance. The review is performed at least half yearly.

- **What is the committed minimum rate to reduce the scope of the investments considered prior to the application of that investment strategy?**

The Sub-Fund does not commit to reduce the scope of the investments by a certain minimum rate.

- **What is the policy to assess good governance practices of the investee companies?**

Good governance principles are considered by screening out companies based on their involvement in controversies around international norms corresponding to the four good governance practices: sound management structures, employee relations, remuneration of staff and tax compliance. Companies having a severe violation in either of those areas will not be investible. For certain cases, flagged issuers shall be on a watch list. These companies will appear on this watch list when the Investment Manager believes that engagement may lead to improvements or when the company is assessed to take remedial actions. Companies on the watch list remain investible unless the Investment Manager believes that the engagement or the remedial actions of the company does not lead to the desired remedy of the severe controversy.

In addition, the Sub-Fund's Investment Manager is committed to actively encourage open dialogues with investee companies on corporate governance, proxy voting and broader sustainability issues in advance of shareholder meetings (regularly for direct investments in shares). The Sub-Fund's Investment Manager's approach to proxy voting and company engagement is set out in the Management Company's Stewardship Statement.

Good governance practices include sound management structures, employee relations, remuneration of staff and tax compliance.



What is the asset allocation planned for this financial product?

Asset allocation describes the share of investments in specific assets.

Min. 70% of the Sub-Funds' assets (excluding cash, and derivatives) are used to meet the environmental or social characteristics promoted by this Sub-Fund. A low portion of the Sub-Fund might contain assets which do not promote environmental or social characteristics. Example of such instruments are derivatives, cash and deposits, some Target Funds and investment with temporarily divergent or absent environmental, social, or good governance qualifications. Min. 5% of the Sub-Funds' assets will be invested in Sustainable Investments. The minimum percentage of investments that are aligned with the EU Taxonomy is 0.01%. The Sub-Fund's Investment Manager does not commit to a minimum share of environmentally Sustainable Investments that are not aligned with the EU Taxonomy. The Sub-Fund's Investment Manager does not commit to a minimum share of socially sustainable investments. While the Sub-Fund cannot commit to a minimum share of environmentally or socially sustainable investments, such investments may be freely allocated to within the Sub-Fund aggregated sustainable investment commitment disclosed (min. 5%).

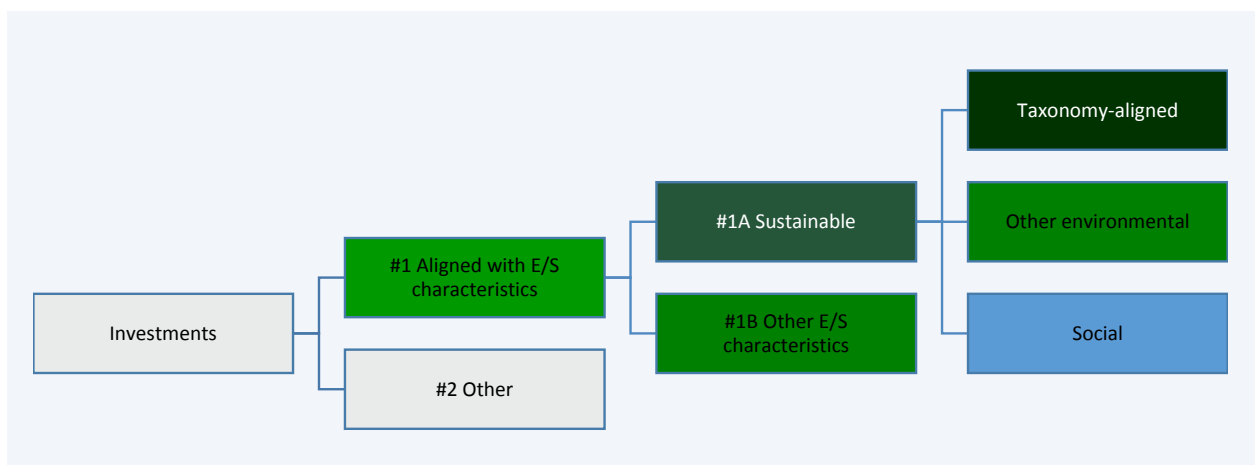

#1 Aligned with E/S characteristics includes the investments of the financial product used to attain the environmental or social characteristics promoted by the financial product.

#2 Other includes the remaining investments of the financial product which are neither aligned with the environmental or social characteristics, nor are qualified as sustainable investments.

The category **#1 Aligned with E/S characteristics** covers:

- The sub-category **#1A Sustainable** covers sustainable investments with environmental or social objectives.

- The sub-category #1B Other E/S characteristics covers investments aligned with the environmental or social characteristics that do not qualify as sustainable investments.

● **How does the use of derivatives attain the environmental or social characteristics promoted by the financial product?**

Not applicable



To what minimum extent are sustainable investments with an environmental objective aligned with the EU Taxonomy?

The Taxonomy-aligned investments include debt and/or equity in environmentally sustainable economic activities aligned with the EU-Taxonomy. The minimum percentage of investments that are aligned with the EU Taxonomy is 0.01%. Taxonomy-aligned data is provided by an external data provider. The Investment Manager has assessed the quality of such data. The data will not be subject to an assurance provided by auditors or a review by third parties. The data will not reflect any data in government bonds. As of today, there is no recognized methodology available to determine the proportion of Taxonomy-aligned activities when investing in government bonds.

Taxonomy-aligned activities in this disclosure are based on share of turnover. Pre-contractual figures use turnover as its financial metric as a default in line with the regulatory requirements and based on the fact that complete, verifiable or up-to date data for CAPEX and/or OPEX as financial metric is even less available.

Taxonomy-aligned data is only in rare cases data reported by companies in accordance with the EU Taxonomy. The data provider has derived Taxonomy-aligned data from other available equivalent public data.

● **Does the financial product invest in fossil gas and/or nuclear energy related activities that comply with the EU Taxonomy ¹?**

- Yes:
 In fossil gas In nuclear energy
 No

The Sub-Fund does not pursue any investments in fossil gas and/or nuclear energy related activities that comply with the EU Taxonomy. Nevertheless, as result of this investment strategy, investments may occur in corporates which are also active in these activities. Further information will be provided as part of the annual reporting, if relevant.

The two graphs below show in green the minimum percentage of investments that are aligned with the EU Taxonomy. As there is no appropriate methodology to determine the Taxonomy-alignment of sovereign bonds*, the first graph shows the Taxonomy-alignment in relation to all the investments of the financial product including sovereign bonds, while the second graph shows the Taxonomy-alignment only in relation to the investments of the financial product other than sovereign bonds.

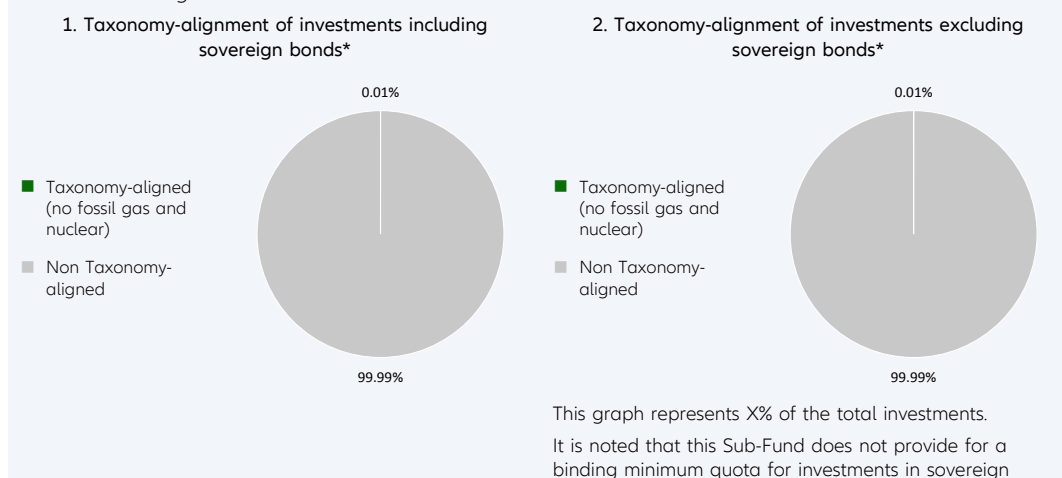

¹ Fossil gas and/or nuclear related activities will only comply with the EU Taxonomy where they contribute to limiting climate change ("climate change mitigation") and do not significantly harm any EU Taxonomy objective - see explanatory note in the left hand margin. The full criteria for fossil gas and nuclear energy economic activities that comply with the EU Taxonomy are laid down in Commission Delegated Regulation (EU) 2022/1214.

bonds. Therefore, this Sub-Fund may have (but must not have) an exposure to sovereign bonds. In the absence of a binding minimum quota for investments in sovereign bonds, this graph does not generate any additional added value compared to the left-hand graph.

** For the purpose of these graphs, 'sovereign bonds' consist of all sovereign exposures*

Enabling activities directly enable other activities to make a substantial contribution to an environmental objective.

Transitional activities are activities for which low-carbon alternatives are not yet available and among others have greenhouse gas emission levels corresponding to the best performance.

● What is the minimum share of investments in transitional and enabling activities?

The Sub-Fund's Investment Manager does not commit to a split of minimum taxonomy alignment into transitional, enabling activities and own performance.



What is the minimum share of sustainable investments with an environmental objective that are not aligned with the EU Taxonomy?

Taxonomy-aligned investments are considered a sub-category of Sustainable Investments. If an investment is not Taxonomy-aligned since the activity is not yet covered under the EU Taxonomy or the positive contribution is not substantial enough to comply with the Taxonomy technical screening criteria, the investment can still be considered an environmentally Sustainable Investment provided it complies with all criteria. The Investment Manager does not commit to a minimum share of environmentally Sustainable Investments that are not aligned with the EU Taxonomy. The overall sustainable investment share may also include investments with an environmental objective in economic activities that do not qualify as environmentally sustainable under the EU Taxonomy, and while the Sub-Fund cannot commit to a minimum share of environmentally or socially sustainable investments, such investments may be freely allocated to within the Sub-Fund aggregated sustainable investment commitment disclosed (min. 5%).



are sustainable investments with an environmental objective that **do not take into account the criteria** for environmentally sustainable economic activities under the EU Taxonomy.



What is the minimum share of socially sustainable investments?

The Investment Manager defines Sustainable Investments based on internal research, which uses, among others, the UN Sustainable Development Goals (SDGs), as well as the objectives of the EU Taxonomy as reference frameworks. The Investment Manager does not commit to a minimum share of socially Sustainable Investments, as the SDGs contain environmental as well as social objectives. The overall sustainable investment share may also include investments with a social objective, and while the Sub-Fund cannot commit to a minimum share of environmentally or socially sustainable investments, such investments may be freely allocated to within the Sub-Fund aggregated sustainable investment commitment disclosed (min. 5%).



What investments are included under “#2 Other”, what is their purpose and are there any minimum environmental or social safeguards?

Under “#2 Other” investments into cash, Target Funds, or derivatives can be included. Derivatives might be used for efficient portfolio management (including risk hedging) and/or investment purposes, and Target Funds to benefit from a specific strategy. For those investments no environmental or social safeguards are applied.



Is a specific index designated as a reference benchmark to determine whether this financial product is aligned with the environmental and/or social characteristics that it promotes?

Yes, the Sub-Fund has assigned the ICE BOFAML Euro High Yield BB-B Constrained as a benchmark. This benchmark is a market index. The Sub-Fund will promote environmental and social characteristics by outperforming the benchmark's Weighted Average GHG Intensity.

Reference benchmarks are indexes to measure whether the financial product attains the environmental or social characteristics that they promote.

- **How is the reference benchmark continuously aligned with each of the environmental or social characteristics promoted by the financial product?**

The benchmark is a market index and does not incorporate environmental or social characteristics for index construction.

- **How is the alignment of the investment strategy with the methodology of the index ensured on a continuous basis?**

The benchmark is not continuously aligned as it does not incorporate environmental or social characteristics for index construction.

- **How does the designated index differ from a relevant broad market index?**

The benchmark is a broad market index.

- **Where can the methodology used for the calculation of the designated index be found?**

Details of the Benchmark's methodology may be found at <https://indices.theice.com/>



Where can I find more product specific information online?

More product-specific information can be found on the website: <https://regulatory.allianzgi.com/SFDR>

Template pre-contractual disclosure for the financial products referred to in Article 8, paragraphs 1, 2 and 2a, of Regulation (EU) 2019/2088 and Article 6, first paragraph, of Regulation (EU) 2020/852

Product name:

Allianz Euro High Yield Defensive

Legal entity identifier: 529900SMJDSY6ZOGRB53

Environmental and/or social characteristics

Sustainable investment means an investment in an economic activity that contributes to an environmental or social objective, provided that the investment does not significantly harm any environmental or social objective and that the investee companies follow good governance practices.

The **EU Taxonomy** is a classification system laid down in Regulation (EU) 2020/852, establishing a list of **environmentally sustainable economic activities**. That Regulation does not include a list of socially sustainable economic activities. Sustainable investments with an environmental objective might be aligned with the Taxonomy or not.

Does this financial product have a sustainable investment objective?	
Yes	No
<input type="checkbox"/> It will make a minimum of sustainable investments with an environmental objective : ____% <input type="checkbox"/> in economic activities that qualify as environmentally sustainable under the EU Taxonomy <input type="checkbox"/> in economic activities that do not qualify as environmentally sustainable under the EU Taxonomy	<input checked="" type="checkbox"/> It promotes Environmental/Social (E/S) characteristics and while it does not have as its objective a sustainable investment, it will have a minimum proportion of 20.00% of sustainable investments <input checked="" type="checkbox"/> with an environmental objective in economic activities that qualify as environmentally sustainable under the EU Taxonomy <input checked="" type="checkbox"/> with an environmental objective in economic activities that do not qualify as environmentally sustainable under the EU Taxonomy <input checked="" type="checkbox"/> with a social objective
<input type="checkbox"/> It will make a minimum of sustainable investments with a social objective ____%	<input type="checkbox"/> It promotes E/S characteristics, but will not make any sustainable investments



What environmental and/or social characteristics are promoted by this financial product?

Allianz Euro High Yield Defensive (the "Sub-Fund") is managed according to the Sustainability Key Performance Indicator Strategy (Absolute Threshold) ("KPI Strategy (Absolute Threshold)") which targets a specific minimum allocation into Sustainable Investments. Sustainable investments are investments in economic activities which contribute to environmental and/or social objectives, for which the Investment Managers uses as reference frameworks the UN Sustainable Development Goals (SDGs), as well as the objectives of the EU Taxonomy.

Furthermore, the Sub-Fund will limit its allocation into issuers which significantly harm environmental and/or social objectives.

In addition, sustainable minimum exclusion criteria apply.

No reference benchmark has been designated for the purpose of attaining the environmental and/or social characteristics promoted by the Sub-Fund.

● What sustainability indicators are used to measure the attainment of each of the environmental or social characteristics promoted by this financial product?

To measure the attainment of the environmental and/or social characteristics the following sustainability indicators are used and reported on, at the fiscal year end:

- The actual percentage of KPI coverage of the Sub-Fund's Portfolio (Portfolio in this respect does not comprise derivatives and instruments that are non-evaluated by nature (e. g., cash and deposits)).
- The actual weighted average sustainable investment share of Sub-Fund Assets.

Sustainability indicators measure how the environmental or social characteristics promoted by the financial product are attained.

- The actual share of investments not satisfying the Do No Significant Harm (“DNSH”) assessment of Sub-Fund Assets.
 - Confirmation that Principal Adverse Impacts (PAIs) of investment decisions on sustainability factors are considered through the application of exclusion criteria.
- **What are the objectives of the sustainable investments that the financial product partially intends to make and how does the sustainable investment contribute to such objectives?**

Sustainable investments contribute to environmental and/or social objectives, for which the Investment Manager uses as reference frameworks, among others, the UN Sustainable Development Goals (SDGs), as well as the objectives of the EU Taxonomy:

1. Climate Change Mitigation
2. Climate Change Adaptation
3. Sustainable Use and Protection of Water and Marine Resources
4. Transition to a Circular Economy
5. Pollution Prevention and Control
6. Protection and Restoration of Biodiversity and Ecosystems

The assessment of the positive contribution to the environmental or social objectives is based on a proprietary framework which combines quantitative elements with qualitative inputs from internal research. The methodology applies first a quantitative breakdown of a securities issuer into its business activities. The qualitative element of the framework is an assessment if business activities contribute positively to an environmental or a social objective.

To calculate the positive contribution on the Sub-Fund level the revenue share of each issuer attributable to business activities contributing to environmental and/or social objectives is considered provided the issuer is satisfying the Do No Significant Harm (“DNSH”) and Good Governance principles, and an asset-weighted aggregation is performed as a second step. Moreover, for certain types of securities, which finance specific projects contributing to environmental or social objectives the overall investment is considered to contribute to environmental and/or social objectives, but also for these a DNSH as well as a Good Governance check for issuers is performed.

- **How do the sustainable investments that the financial product partially intends to make, not cause significant harm to any environmental or social sustainable investment objective?**

In order to ensure that Sustainable Investments do not significantly harm any other environmental and/or social objective, the Investment Manager is leveraging the PAI indicators, whereby significance thresholds have been defined to identify significantly harmful issuers. Issuers not meeting the significance threshold can be engaged for a limited time period to remediate the adverse impact. Otherwise, if the issuer does not meet the defined significance thresholds twice subsequently or in case of a failed engagement, it does not pass the DNSH assessment. Investments in securities of issuers which do not pass the DNSH assessment are not counted as sustainable investments.

- *How have the indicators for adverse impacts on sustainability factors been taken into account?*

All mandatory PAI indicators are considered either as part of the application of the exclusion criteria or through thresholds on a sectorial or absolute basis. Significance thresholds have been defined and they refer to qualitative or quantitative criteria.

Recognizing the lack of data coverage for some of the PAI indicators equivalent data points are used to assess PAI indicators when applying the DNSH assessment, when relevant, for the following indicators for corporates: share of non-renewable energy consumption and production, activities negatively affecting biodiversity-sensitive areas, emissions to water, lack of processes and compliance mechanisms to monitor compliance with UNGC principles and OECD Guidelines for Multinational Enterprises; for sovereigns: GHG Intensity and investee countries subject to social violations. In case of securities which finance specific projects contributing to environmental or social objectives equivalent data at project level might be used to ensure that Sustainable Investments do not significantly harm any other environmental and/or social objective. The Investment Manager will strive to increase data coverage for PAI indicators with low data coverage by engaging with issuers and data providers. The Investment Manager will regularly evaluate whether the availability of data has increased sufficiently to potentially include assessment of such data in the investment process.

Principal adverse impacts are the most significant negative impacts of investment decisions on sustainability factors relating to environmental, social and employee matters, respect for human rights, anti-corruption and anti-bribery matters.

- *How are the sustainable investments aligned with the OECD Guidelines for Multinational Enterprises and the UN Guiding Principles on Business and Human Rights? Details:*

The Investment Manager's sustainable minimum exclusion list screens out companies based on their involvement in controversial practices against international norms. The core normative framework consists of the Principles of the UN Global Compact, the OECD Guidelines for Multinational Enterprises and the UN Guiding Principles for Business and Human Rights. Securities issued by companies having a severe violation of these frameworks will be restricted from the investment universe.

The EU Taxonomy sets out a "do not significant harm" principle by which Taxonomy-aligned investments should not significantly harm EU Taxonomy objectives and is accompanied by specific EU criteria.

The "do not significant harm" principle applies only to those investments underlying the financial product that take into account the EU criteria for environmentally sustainable economic activities. The investments underlying the remaining portion of this financial product do not take into account the EU criteria for environmentally sustainable economic activities.

Any other sustainable investments must also not significantly harm any environmental or social objectives.



Does this financial product consider principal adverse impacts on sustainability factors?

Yes

No

The Management Company has joined the Net Zero Asset Manager Initiative and considers PAI indicators through stewardship including engagement, both are relevant to mitigate potential adverse impact as a company.

Due to the commitment to the Net Zero Asset Manager Initiative, the Management Company aims to reduce greenhouse gas emissions in partnership with asset owner clients on decarbonisation goals, consistent with an ambition to reach net zero emission by 2050 or sooner across all assets under management. As part of this objective the Management Company will set an interim target for the proportion of assets to be managed in line with the attainment of net zero emissions by 2050 or sooner.

The Sub-Fund's Investment Manager addresses PAI indicators regarding greenhouse gas emission, biodiversity, water, waste as well as social and employee matters for corporate issuers, and, where relevant, the freedom house index is applied to investments in sovereigns. PAI indicators are considered within the Investment Manager's investment process through the means of exclusions as described in the "binding elements" section of the Sub-Fund.

The data coverage for the data required for the PAI indicators is heterogenous. The data coverage related to biodiversity, water and waste is low and the related PAI indicators are considered through exclusion of securities issued by companies having a severe violation / breach of principles and guidelines such as the Principles of the United Nations Global Compact, the OECD Guidelines for Multinational Enterprises, and the United Nations Guiding Principles for Business and Human Rights on the grounds of problematic practices around human rights, labour rights, environment, and corruption issues. Therefore, the Investment Manager will strive to increase data coverage for PAI indicators with low data coverage. The Investment Manager will regularly evaluate whether the availability of data has increased sufficiently to potentially include assessment of such data in the investment process.

Additionally, the investment Manager considers PAI indicators by limiting its allocation into issuers which significantly harm environmental and/or social objectives.

The following PAI indicators are considered:

Applicable to corporate issuers

- GHG Emissions
- Carbon footprint
- GHG Intensity of investee companies
- Exposure to companies active in the fossil fuel sector
- Activities negatively affecting biodiversity-sensitive areas
- Emissions to water
- Hazardous waste ratio

- Violation of UN Global compact principles
- Lack of processes and compliance mechanisms to monitor compliance with UN Global Compact principles
- Board gender diversity
- Exposure to controversial weapons

Applicable to sovereign and supranational issuers

- Investee countries subject to social violations

The information on the PAI indicators will be available in the end-year report of the Sub-Fund.



What investment strategy does this financial product follow?

The investment strategy guides investment decisions based on factors such as investment objectives and risk tolerance.

Allianz Euro High Yield Defensive's investment objective is to invest in Debt Securities of European bond markets in accordance with the Sustainability Key Performance Indicator Strategy (Absolute Threshold) ("KPI Strategy (Absolute Threshold)"). The Sub-Fund's strategy is to target a specific minimum allocation into Sustainable Investments and limit its allocation to DNSH.

The proportion of assets which do not have a Sustainable Investment share assessment is expected to be low. Examples of instruments not having a Sustainable Investment share assessment are cash and deposits, some Target Funds, and investments for which data is not available.

The Sub-Fund's general investment approach (Sub-Fund's applicable General Asset Class Principles in combination with its individual investment restrictions) is described in the prospectus.

● What are the binding elements of the investment strategy used to select the investments to attain each of the environmental or social characteristics promoted by this financial product?

The investment strategy adheres to the following binding elements to attain the environmental and/ or social characteristics promoted:

- Min. 70% of Sub-Fund's portfolio shall be invested in companies which have been assessed according to the Sustainable Investment methodology (Portfolio in this respect does not comprise derivatives and instruments that are non-evaluated by nature (e. g., cash and deposits)).
- Min. 20% of weighted-average Sustainable Investment share at Sub Fund Assets. If the Investment Manager acquires a use of proceed security, which finance specific projects contributing to environmental or social objectives, the overall investment is considered to contribute to environmental and/or social objectives according to the Sustainable Investment methodology.
- Max. 10% of Sub-Fund assets will be invested in securities from issuers not satisfying the Do No Significant Harm ("DNSH") principles.- Application of the following sustainable minimum exclusion criteria for direct investments:
 - securities issued by companies having a severe violation / breach of principles and guidelines such as the Principles of the United Nations Global Compact, the OECD Guidelines for Multinational Enterprises, and the United Nations Guiding Principles for Business and Human Rights on the grounds of problematic practices around human rights, labour rights, environment, and corruption,
 - securities issued by companies involved in controversial weapons (anti-personnel mines, cluster munitions, chemical weapons, biological weapons, depleted uranium, white phosphorus, and nuclear weapons),
 - securities issued by companies that derive more than 10% of their revenues from weapons, military equipment, and services,
 - securities issued by companies that derive more than 10% of their revenue from thermal coal extraction
 - securities issued by utility companies that generate more than 20% of their revenues from coal,
 - securities issued by companies involved in the production of tobacco, and securities issued by companies involved in the distribution of tobacco with more than 5% of their revenues.

Direct investments in sovereign issuers with an insufficient freedom house index score are excluded.

The sustainable minimum exclusion criteria are based on information from an external data provider and coded in pre- and post-trade compliance. The review is performed at least half yearly.

- **What is the committed minimum rate to reduce the scope of the investments considered prior to the application of that investment strategy?**

The Sub-Fund does not commit to reduce the scope of the investments by a certain minimum rate.

- **What is the policy to assess good governance practices of the investee companies?**

Good governance principles are considered by screening out companies based on their involvement in controversies around international norms corresponding to the four good governance practices: sound management structures, employee relations, remuneration of staff and tax compliance. Companies having a severe violation in either of those areas will not be investible. For certain cases, flagged issuers shall be on a watch list. These companies will appear on this watch list when the Investment Manager believes that engagement may lead to improvements or when the company is assessed to take remedial actions. Companies on the watch list remain investible unless the Investment Manager believes that the engagement or the remedial actions of the company does not lead to the desired remedy of the severe controversy.

In addition, the Sub-Fund's Investment Manager is committed to actively encourage open dialogues with investee companies on corporate governance, proxy voting and broader sustainability issues in advance of shareholder meetings (regularly for direct investments in shares). The Sub-Fund's Investment Manager's approach to proxy voting and company engagement is set out in the Management Company's Stewardship Statement.

Good governance practices include sound management structures, employee relations, remuneration of staff and tax compliance.



What is the asset allocation planned for this financial product?

Asset allocation describes the share of investments in specific assets.

Min. 70% of the Sub-Funds' assets (excluding cash, and derivatives) are used to meet the environmental or social characteristics promoted by this Sub-Fund. A low portion of the Sub-Fund might contain assets which do not promote environmental or social characteristics. Example of such instruments are derivatives, cash and deposits, some Target Funds and investment with temporarily divergent or absent environmental, social, or good governance qualifications. Min. 20% of the Sub-Funds' assets will be invested in Sustainable Investments. The minimum percentage of investments that are aligned with the EU Taxonomy is 0.01%. The Sub-Fund's Investment Manager does not commit to a minimum share of environmentally Sustainable Investments that are not aligned with the EU Taxonomy. The Sub-Fund's Investment Manager does not commit to a minimum share of socially sustainable investments. While the Sub-Fund cannot commit to a minimum share of environmentally or socially sustainable investments, such investments may be freely allocated to within the Sub-Fund aggregated sustainable investment commitment disclosed (min. 20%).

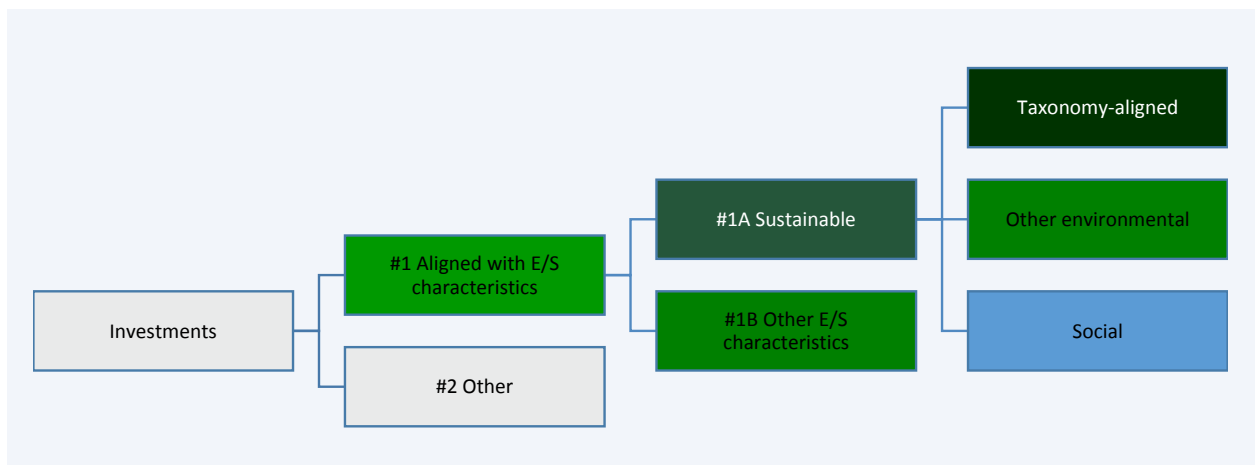

#1 Aligned with E/S characteristics includes the investments of the financial product used to attain the environmental or social characteristics promoted by the financial product.

#2 Other includes the remaining investments of the financial product which are neither aligned with the environmental or social characteristics, nor are qualified as sustainable investments.

The category **#1 Aligned with E/S characteristics** covers:

- The sub-category **#1A Sustainable** covers sustainable investments with environmental or social objectives.
- The sub-category **#1B Other E/S characteristics** covers investments aligned with the environmental or social characteristics that do not qualify as sustainable investments.

- How does the use of derivatives attain the environmental or social characteristics promoted by the financial product?

Not applicable



To what minimum extent are sustainable investments with an environmental objective aligned with the EU Taxonomy?

The Taxonomy-aligned investments include debt and/or equity in environmentally sustainable economic activities aligned with the EU-Taxonomy. The minimum percentage of investments that are aligned with the EU Taxonomy is 0.01%. Taxonomy-aligned data is provided by an external data provider. The Investment Manager has assessed the quality of such data. The data will not be subject to an assurance provided by auditors or a review by third parties. The data will not reflect any data in government bonds. As of today, there is no recognized methodology available to determine the proportion of Taxonomy-aligned activities when investing in government bonds.

Taxonomy-aligned activities in this disclosure are based on share of turnover. Pre-contractual figures use turnover as its financial metric as a default in line with the regulatory requirements and based on the fact that complete, verifiable or up-to date data for CAPEX and/or OPEX as financial metric is even less available.

Taxonomy-aligned data is only in rare cases data reported by companies in accordance with the EU Taxonomy. The data provider has derived Taxonomy-aligned data from other available equivalent public data.

- Does the financial product invest in fossil gas and/or nuclear energy related activities that comply with the EU Taxonomy ¹?

Yes:

In fossil gas In nuclear energy

No

The Sub-Fund does not pursue any investments in fossil gas and/or nuclear energy related activities that comply with the EU Taxonomy. Nevertheless, as result of this investment strategy, investments may occur in corporates which are also active in these activities. Further information will be provided as part of the annual reporting, if relevant.

The two graphs below show in green the minimum percentage of investments that are aligned with the EU Taxonomy. As there is no appropriate methodology to determine the Taxonomy-alignment of sovereign bonds*, the first graph shows the Taxonomy-alignment in relation to all the investments of the financial product including sovereign bonds, while the second graph shows the Taxonomy-alignment only in relation to the investments of the financial product other than sovereign bonds.

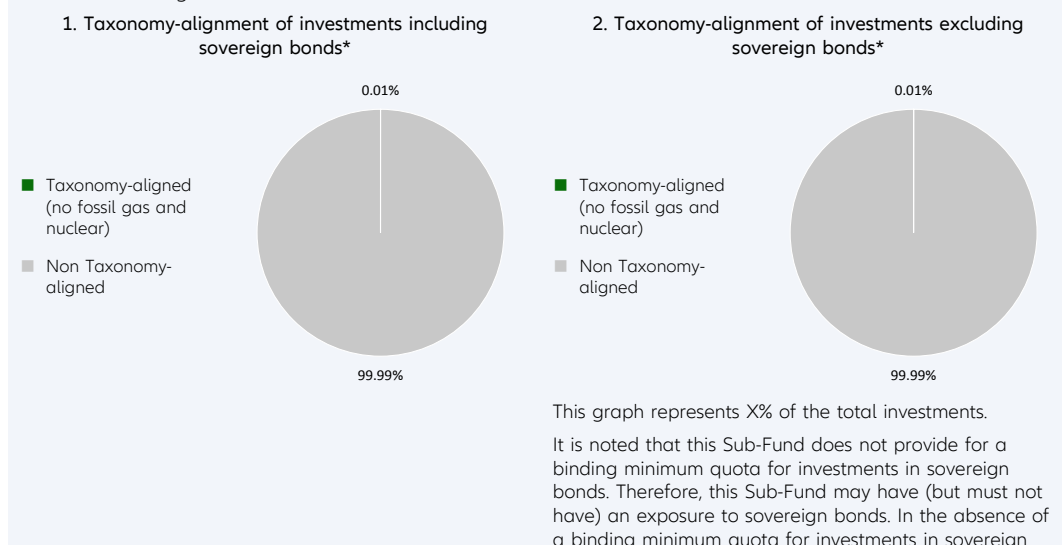

¹ Fossil gas and/or nuclear related activities will only comply with the EU Taxonomy where they contribute to limiting climate change ("climate change mitigation") and do not significantly harm any EU Taxonomy objective - see explanatory note in the left hand margin. The full criteria for fossil gas and nuclear energy economic activities that comply with the EU Taxonomy are laid down in Commission Delegated Regulation (EU) 2022/1214.

bonds, this graph does not generate any additional added value compared to the left-hand graph.

* For the purpose of these graphs, 'sovereign bonds' consist of all sovereign exposures

Enabling activities directly enable other activities to make a substantial contribution to an environmental objective.

Transitional activities are activities for which low-carbon alternatives are not yet available and among others have greenhouse gas emission levels corresponding to the best performance.

● What is the minimum share of investments in transitional and enabling activities?

The Sub-Fund's Investment Manager does not commit to a split of minimum taxonomy alignment into transitional, enabling activities and own performance.



What is the minimum share of sustainable investments with an environmental objective that are not aligned with the EU Taxonomy?

Taxonomy-aligned investments are considered a sub-category of Sustainable Investments. If an investment is not Taxonomy-aligned since the activity is not yet covered under the EU Taxonomy or the positive contribution is not substantial enough to comply with the Taxonomy technical screening criteria, the investment can still be considered an environmentally Sustainable Investment provided it complies with all criteria. The Investment Manager does not commit to a minimum share of environmentally Sustainable Investments that are not aligned with the EU Taxonomy. The overall sustainable investment share may also include investments with an environmental objective in economic activities that do not qualify as environmentally sustainable under the EU Taxonomy, and while the Sub-Fund cannot commit to a minimum share of environmentally or socially sustainable investments, such investments may be freely allocated to within the Sub-Fund aggregated sustainable investment commitment disclosed (min 20%).



are sustainable investments with an environmental objective that **do not take into account the criteria** for environmentally sustainable economic activities under the EU Taxonomy.



What is the minimum share of socially sustainable investments?

The Investment Manager defines Sustainable Investments based on internal research, which uses, among others, the UN Sustainable Development Goals (SDGs), as well as the objectives of the EU Taxonomy as reference frameworks. The Investment Manager does not commit to a minimum share of socially Sustainable Investments, as the SDGs contain environmental as well as social objectives. The overall sustainable investment share may also include investments with a social objective, and while the Sub-Fund cannot commit to a minimum share of environmentally or socially sustainable investments, such investments may be freely allocated to within the Sub-Fund aggregated sustainable investment commitment disclosed (min 20%).



What investments are included under "#2 Other", what is their purpose and are there any minimum environmental or social safeguards?

Under "#2 Other" investments into cash, Target Funds, or derivatives can be included. Derivatives might be used for efficient portfolio management (including risk hedging) and/or investment purposes, and Target Funds to benefit from a specific strategy. For those investments no environmental or social safeguards are applied.



Is a specific index designated as a reference benchmark to determine whether this financial product is aligned with the environmental and/or social characteristics that it promotes?

No reference benchmark has been designated for the purpose of attaining the environmental and/or social characteristics promoted by the Sub-Fund.

Reference benchmarks are indexes to measure whether the financial product attains the environmental or social characteristics that they promote.

- **How is the reference benchmark continuously aligned with each of the environmental or social characteristics promoted by the financial product?**
Not applicable
- **How is the alignment of the investment strategy with the methodology of the index ensured on a continuous basis?**
Not applicable
- **How does the designated index differ from a relevant broad market index?**
Not applicable
- **Where can the methodology used for the calculation of the designated index be found?**
Not applicable



Where can I find more product specific information online?

More product-specific information can be found on the website: <https://regulatory.allianzgi.com/SFDR>

Template pre-contractual disclosure for the financial products referred to in Article 8, paragraphs 1, 2 and 2a, of Regulation (EU) 2019/2088 and Article 6, first paragraph, of Regulation (EU) 2020/852

Product name:

Allianz Euro Inflation-linked Bond

Legal entity identifier: 52990048RHLMIXREUF14

Environmental and/or social characteristics

Sustainable investment means an investment in an economic activity that contributes to an environmental or social objective, provided that the investment does not significantly harm any environmental or social objective and that the investee companies follow good governance practices.

The EU Taxonomy is a classification system laid down in Regulation (EU) 2020/852, establishing a list of **environmentally sustainable economic activities**. That Regulation does not include a list of socially sustainable economic activities. Sustainable investments with an environmental objective might be aligned with the Taxonomy or not.

Does this financial product have a sustainable investment objective?

Yes

No

It will make a minimum of **sustainable investments with an environmental objective**: ___%

in economic activities that qualify as environmentally sustainable under the EU Taxonomy

in economic activities that do not qualify as environmentally sustainable under the EU Taxonomy

It will make a minimum of **sustainable investments with a social objective** ___%

It **promotes Environmental/Social (E/S) characteristics** and while it does not have as its objective a sustainable investment, it will have a minimum proportion of ___% of sustainable investments

with an environmental objective in economic activities that qualify as environmentally sustainable under the EU Taxonomy

with an environmental objective in economic activities that do not qualify as environmentally sustainable under the EU Taxonomy

with a social objective

It promotes E/S characteristics, but **will not make any sustainable investments**



What environmental and/or social characteristics are promoted by this financial product?

Allianz Euro Inflation-linked Bond (the "Sub-Fund") promotes environmental, social, human rights, governance, and business behaviour factors (this domain does not apply for sovereigns issued by a Sovereign Entity) through integration of a best-in-class approach into the Sub-Fund's investment process. This encompasses the evaluation of corporate or sovereign issuers based on an SRI Rating which is used to construct the portfolio.

In addition, sustainable minimum exclusion criteria apply.

No reference benchmark has been designated for the purpose of attaining the environmental and/or social characteristics promoted by the Sub-Fund.

● What sustainability indicators are used to measure the attainment of each of the environmental or social characteristics promoted by this financial product?

To measure the attainment of the environmental and/or social characteristics the following sustainability indicators are used and reported on, at the fiscal year end:

- The actual percentage of the Sub-Fund's Portfolio (Portfolio in this respect does not comprise non-rated derivatives and instruments that are non-rated by nature (e. g., cash and deposits)) assets invested in best-in-class issuers (issuers with a minimum SRI Rating of 2 out of a scale from 0-4; 0 being the worst rating and 4 the best rating) is compared to the actual percentage of the benchmarks best-in-class issuers.
- Confirmation that Principal Adverse Impacts (PAIs) of investment decisions on sustainability factors are considered through the application of exclusion criteria.

Sustainability indicators measure how the environmental or social characteristics promoted by the financial product are attained.

- What are the objectives of the sustainable investments that the financial product partially intends to make and how does the sustainable investment contribute to such objectives?

Not applicable

- How do the sustainable investments that the financial product partially intends to make, not cause significant harm to any environmental or social sustainable investment objective?

Not applicable

- How have the indicators for adverse impacts on sustainability factors been taken into account?

Not applicable

- How are the sustainable investments aligned with the OECD Guidelines for Multinational Enterprises and the UN Guiding Principles on Business and Human Rights? Details:

Not applicable

Principal adverse impacts are the most significant negative impacts of investment decisions on sustainability factors relating to environmental, social and employee matters, respect for human rights, anti-corruption and anti-bribery matters.



Does this financial product consider principal adverse impacts on sustainability factors?

Yes

No

The Management Company has joined the Net Zero Asset Manager Initiative and considers PAI indicators through stewardship including engagement, both are relevant to mitigate potential adverse impact as a company.

Due to the commitment to the Net Zero Asset Manager Initiative, the Management Company aims to reduce greenhouse gas emissions in partnership with asset owner clients on decarbonisation goals, consistent with an ambition to reach net zero emission by 2050 or sooner across all assets under management. As part of this objective the Management Company will set an interim target for the proportion of assets to be managed in line with the attainment of net zero emissions by 2050 or sooner.

The Sub-Fund's Investment Manager considers PAI indicators regarding greenhouse gas emission, biodiversity, water, waste as well as social and employee matters for corporate issuers, and, where relevant, the freedom house index is applied to investments in sovereigns. PAI indicators are considered within the Investment Manager's investment process through the means of exclusions as described in the "binding elements" section of the Sub-Fund.

The data coverage for the data required for the PAI indicators is heterogenous. The data coverage related to biodiversity, water and waste is low and the related PAI indicators are considered through exclusion of securities issued by companies having a severe violation / breach of principles and guidelines such as the Principles of the United Nations Global Compact, the OECD Guidelines for Multinational Enterprises, and the United Nations Guiding Principles for Business and Human Rights on the grounds of problematic practices around human rights, labour rights, environment, and corruption issues. Therefore, the Investment Manager will strive to increase data coverage for PAI indicators with low data coverage. The Investment Manager will regularly evaluate whether the availability of data has increased sufficiently to potentially include assessment of such data in the investment process.

Additionally, PAI indicators are, among other sustainability factors, applied to derive the SRI Rating. The SRI Rating is used for the portfolio construction.

The following PAI indicators are considered:

Applicable to corporate issuers

- GHG Emissions

- Carbon footprint
- GHG Intensity of investee companies
- Exposure to companies active in the fossil fuel sector
- Activities negatively affecting biodiversity-sensitive areas
- Emissions to water
- Hazardous waste ratio
- Violation of UN Global compact principles
- Lack of processes and compliance mechanisms to monitor compliance with UN Global Compact principles
- Board gender diversity
- Exposure to controversial weapons

Applicable to sovereign and supranational issuers

- Investee countries subject to social violations

The information on the PAI indicators will be available in the end-year report of the Sub-Fund.



What investment strategy does this financial product follow?

The investment strategy guides investment decisions based on factors such as investment objectives and risk tolerance.

Allianz Euro Inflation-linked Bond's investment objective is to invest in Debt Securities of OECD or EU Bond Markets with a focus on inflation-linked bonds in accordance with the Sustainable and Responsible Investment Strategy (SRI Strategy).

As part of the SRI best-in-class approach, the Sub-Fund takes environmental, social, human rights, governance, and business behaviour factors into account as follows:

- The aforesaid sustainability factors are analysed through SRI Research by the Investment Manager in order to assess how sustainable development and long-term issues are taken into account in the strategy of an issuer. SRI Research means the overall process of identifying potential risks as well as potential opportunities of an investment in securities of an issuer related to the analysis of sustainability factors. SRI Research data combines external research data (which might have some limitations) with internal analyses.
- Based on a combination of the results of the external and/or internal analyses of the sustainability factors, an internal rating is derived monthly (SRI Rating) and is afterwards assigned to a corporate or sovereign issuer.

This internal SRI Rating is used to rank and select or weight securities for the portfolio construction.

The Sub-Fund's general investment approach (Sub-Fund's applicable General Asset Class Principles in combination with its individual investment restrictions) is described in the prospectus.

● What are the binding elements of the investment strategy used to select the investments to attain each of the environmental or social characteristics promoted by this financial product?

The binding elements are:

- Minimum rating coverage: At least 90% of the Sub-Fund's portfolio is required to have an SRI Rating (portfolio in this respect does not comprise non-rated derivatives and instruments that are non-rated by nature e.g., cash and deposits). While most holdings of the Sub-Fund will have a corresponding SRI Rating some investments cannot be rated according to the SRI Research methodology. Examples of instruments not attaining to the SRI Rating include, but are not limited to cash, deposits, Target Funds, and non-rated investments.
- 90% of the rated instruments are adhering to the minimum rating threshold of 2 (out of a rating scale from 0 – 4; 0 being the worst rating and 4 the best rating), and 10% are adhering to a rating threshold between 1,5 and 2.
- Application of the following sustainable minimum exclusion criteria for direct investments:
- securities issued by companies having a severe violation / breach of principles and guidelines such as the Principles of the United Nations Global Compact, the OECD Guidelines for Multinational Enterprises, and the United Nations Guiding Principles for Business and Human Rights on the grounds of problematic practices around human rights, labour rights, environment, and corruption issues,

- securities issued by companies involved in controversial weapons (anti-personnel mines, cluster munitions, chemical weapons, biological weapons, depleted uranium, white phosphorus, and nuclear weapons),
- securities issued by companies that derive more than 10% of their revenues from weapons, military equipment, and services,
- securities issued by companies that derive more than 10% of their revenue from thermal coal extraction,
- securities issued by utility companies that generate more than 20% of their revenues from coal,
- securities issued by companies involved in the production of tobacco, and securities issued by companies involved in the distribution of tobacco with more than 5% of their revenues.

Direct investments in sovereign issuers with an insufficient freedom house index score are excluded.

The sustainable minimum exclusion criteria are based on information from an external data provider and coded in pre- and post-trade compliance. The review is performed at least half yearly.

● **What is the committed minimum rate to reduce the scope of the investments considered prior to the application of that investment strategy?**

The Sub-Fund does not commit to reduce the scope of the investments by a certain minimum rate.

● **What is the policy to assess good governance practices of the investee companies?**

Good governance principles are considered by screening out companies based on their involvement in controversies around international norms corresponding to the four good governance practices: sound management structures, employee relations, remuneration of staff and tax compliance. Companies having a severe violation in either of those areas will not be investible. For certain cases, flagged issuers shall be on a watch list. These companies will appear on this watch list when the Investment Manager believes that engagement may lead to improvements or when the company is assessed to take remedial actions. Companies on the watch list remain investible unless the Investment Manager believes that the engagement or the remedial actions of the company does not lead to the desired remedy of the severe controversy.

In addition, the Sub-Fund's Investment Manager is committed to actively encourage open dialogues with investee companies on corporate governance, proxy voting and broader sustainability issues in advance of shareholder meetings (regularly for direct investments in shares). The Sub-Fund's Investment Manager's approach to proxy voting and company engagement is set out in the Management Company's Stewardship Statement.

Good governance practices include sound management structures, employee relations, remuneration of staff and tax compliance.



What is the asset allocation planned for this financial product?

Asset allocation describes the share of investments in specific assets.

Min. 90% of the Sub-Funds' assets (excluding cash and non-rated derivatives) are used to meet the environmental or social characteristics promoted by this Sub-Fund. A low portion of the Sub-Fund might contain assets which do not promote environmental or social characteristics. Examples of such instruments are derivatives, cash and deposits, some Target Funds and investment with temporarily divergent or absent environmental, social, or good governance qualifications.

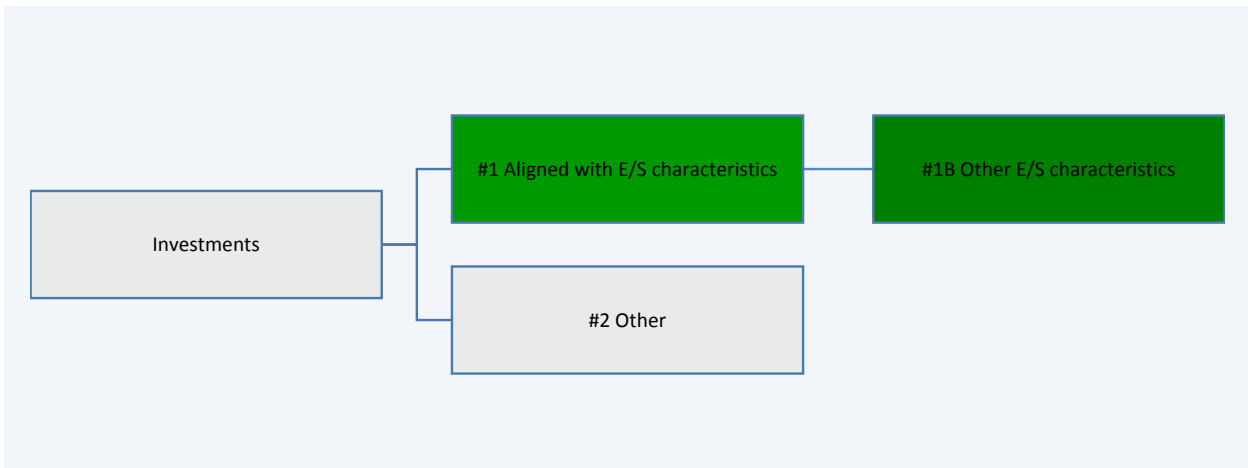

#1 Aligned with E/S characteristics includes the investments of the financial product used to attain the environmental or social characteristics promoted by the financial product.

#2 Other includes the remaining investments of the financial product which are neither aligned with the environmental or social characteristics, nor are qualified as sustainable investments.

The category **#1 Aligned with E/S characteristics** covers:

- The sub-category **#1A Sustainable** covers sustainable investments with environmental or social objectives.
- The sub-category **#1B Other E/S characteristics** covers investments aligned with the environmental or social characteristics that do not qualify as sustainable investments.

● **How does the use of derivatives attain the environmental or social characteristics promoted by the financial product?**

Not applicable



To what minimum extent are sustainable investments with an environmental objective aligned with the EU Taxonomy?

The Sub-Fund's Investment Manager does not commit to a minimum share of sustainable investments with an environmental objective aligned with the EU Taxonomy.

● **Does the financial product invest in fossil gas and/or nuclear energy related activities that comply with the EU Taxonomy¹?**

- Yes:
 - In fossil gas In nuclear energy
- No

Taxonomy-aligned activities are expressed as a share of:

- **turnover** reflecting the share of revenue from green activities of investee companies
- **capital expenditure** (CapEx) showing the green investments made by investee companies, e.g. for a transition to a green economy.
- **operational expenditure** (OpEx) reflecting green operational activities of investee companies.

¹ Fossil gas and/or nuclear related activities will only comply with the EU Taxonomy where they contribute to limiting climate change ("climate change mitigation") and do not significantly harm any EU Taxonomy objective - see explanatory note in the left hand margin. The full criteria for fossil gas and nuclear energy economic activities that comply with the EU Taxonomy are laid down in Commission Delegated Regulation (EU) 2022/1214.

The two graphs below show in green the minimum percentage of investments that are aligned with the EU Taxonomy. As there is no appropriate methodology to determine the Taxonomy-alignment of sovereign bonds*, the first graph shows the Taxonomy-alignment in relation to all the investments of the financial product including sovereign bonds, while the second graph shows the Taxonomy-alignment only in relation to the investments of the financial product other than sovereign bonds.

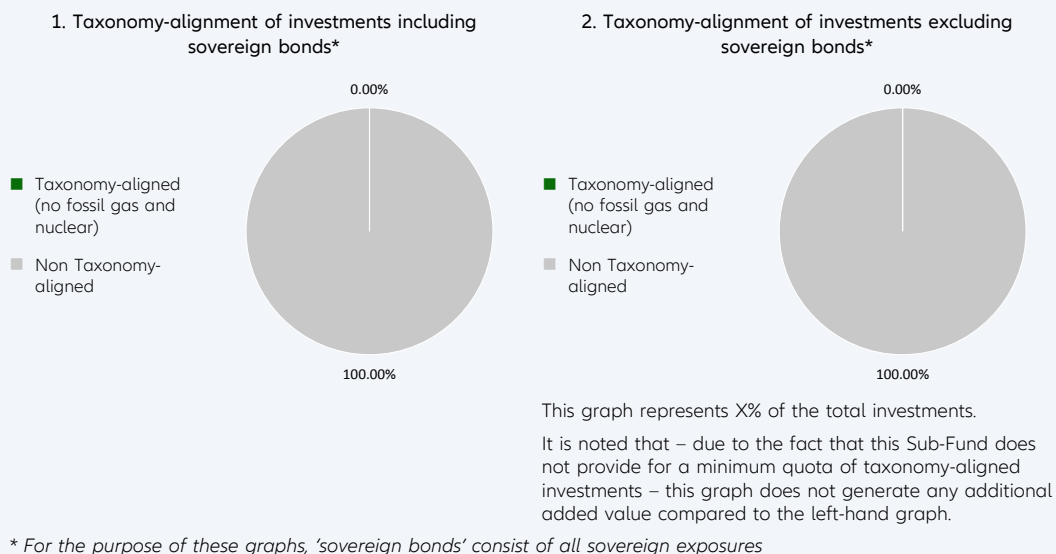

Enabling activities directly enable other activities to make a substantial contribution to an environmental objective.

● **What is the minimum share of investments in transitional and enabling activities?**

The Sub-Fund's Investment Manager does not commit to a split of minimum taxonomy alignment into transitional, enabling activities and own performance.

Transitional activities are activities for which low-carbon alternatives are not yet available and among others have greenhouse gas emission levels corresponding to the best performance.



What is the minimum share of sustainable investments with an environmental objective that are not aligned with the EU Taxonomy?

The Sub-Fund's Investment Manager does not commit to a minimum share of investments with an environmental objective that are not aligned with the EU Taxonomy.

 are sustainable investments with an environmental objective that **do not take into account the criteria** for environmentally sustainable economic activities under the EU Taxonomy.



What is the minimum share of socially sustainable investments?

The Sub-Fund's Investment Manager does not commit to a minimum share of socially sustainable investments.



What investments are included under “#2 Other”, what is their purpose and are there any minimum environmental or social safeguards?

Under “#2 Other” investments into cash, Target Funds, or derivatives can be included. Derivatives might be used for efficient portfolio management (including risk hedging) and/or investment purposes, and Target Funds to benefit from a specific strategy. For those investments no environmental or social safeguards are applied.



Is a specific index designated as a reference benchmark to determine whether this financial product is aligned with the environmental and/or social characteristics that it promotes?

No reference benchmark has been designated for the purpose of attaining the environmental and/or social characteristics promoted by the Sub-Fund.

Reference benchmarks are indexes to measure whether the financial product attains the environmental or social characteristics that they promote.

- How is the reference benchmark continuously aligned with each of the environmental or social characteristics promoted by the financial product?
Not applicable
- How is the alignment of the investment strategy with the methodology of the index ensured on a continuous basis?
Not applicable
- How does the designated index differ from a relevant broad market index?
Not applicable
- Where can the methodology used for the calculation of the designated index be found?
Not applicable



Where can I find more product specific information online?

More product-specific information can be found on the website: <https://regulatory.allianzgi.com/SFDR>

Template pre-contractual disclosure for the financial products referred to in Article 8, paragraphs 1, 2 and 2a, of Regulation (EU) 2019/2088 and Article 6, first paragraph, of Regulation (EU) 2020/852

Product name:

Allianz Euroland Equity Growth

Legal entity identifier: 549300P15C6H38NBO527

Environmental and/or social characteristics

Sustainable investment means an investment in an economic activity that contributes to an environmental or social objective, provided that the investment does not significantly harm any environmental or social objective and that the investee companies follow good governance practices.

The EU Taxonomy is a classification system laid down in Regulation (EU) 2020/852, establishing a list of environmentally sustainable economic activities. That Regulation does not include a list of socially sustainable economic activities. Sustainable investments with an environmental objective might be aligned with the Taxonomy or not.

Does this financial product have a sustainable investment objective?	
<input checked="" type="radio"/> <input checked="" type="radio"/> Yes	<input type="radio"/> <input type="radio"/> No
<input type="checkbox"/> It will make a minimum of sustainable investments with an environmental objective: ___% <ul style="list-style-type: none"> <input type="checkbox"/> in economic activities that qualify as environmentally sustainable under the EU Taxonomy <input type="checkbox"/> in economic activities that do not qualify as environmentally sustainable under the EU Taxonomy 	<input type="checkbox"/> It promotes Environmental/Social (E/S) characteristics and while it does not have as its objective a sustainable investment, it will have a minimum proportion of ___% of sustainable investments <ul style="list-style-type: none"> <input type="checkbox"/> with an environmental objective in economic activities that qualify as environmentally sustainable under the EU Taxonomy <input type="checkbox"/> with an environmental objective in economic activities that do not qualify as environmentally sustainable under the EU Taxonomy <input type="checkbox"/> with a social objective
<input type="checkbox"/> It will make a minimum of sustainable investments with a social objective ___%	<input checked="" type="checkbox"/> It promotes E/S characteristics, but will not make any sustainable investments



What environmental and/or social characteristics are promoted by this financial product?

Allianz Euroland Equity Growth (the "Sub-Fund") is managed according to the Sustainability Key Performance Indicator Strategy (Relative) ("KPI Strategy (Relative)") which addresses greenhouse gas (GHG) Intensity. The "Sustainability KPI" measures the GHG Intensity defined by the weighted average intensity of greenhouse gas emissions based on company's annual sales ("GHG Intensity").

GHG Intensity will be addressed by outperforming the Weighted Average GHG Intensity against its benchmark.

In addition, sustainable minimum exclusion criteria apply.

A reference benchmark has been designated for the purpose of attaining the environmental and/or social characteristics promoted by the Sub-Fund.

● What sustainability indicators are used to measure the attainment of each of the environmental or social characteristics promoted by this financial product?

To measure the attainment of the environmental and/or social characteristics the following sustainability indicators are used and reported on, at the fiscal year end:

- The actual percentage of KPI coverage of the Sub-Fund's Portfolio (Portfolio in this respect does not comprise derivatives and instruments that are non-evaluated by nature (e. g., cash and deposits)).
- The actual weighted average GHG Intensity portfolio vs weighted average GHG Intensity of the benchmark.

Sustainability indicators measure how the environmental or social characteristics promoted by the financial product are attained.

- Confirmation that Principal Adverse Impacts (PAIs) of investment decisions on sustainability factors are considered through the application of exclusion criteria.

- **What are the objectives of the sustainable investments that the financial product partially intends to make and how does the sustainable investment contribute to such objectives?**

Not applicable

- **How do the sustainable investments that the financial product partially intends to make, not cause significant harm to any environmental or social sustainable investment objective?**

Not applicable

- *How have the indicators for adverse impacts on sustainability factors been taken into account?*

Not applicable

- *How are the sustainable investments aligned with the OECD Guidelines for Multinational Enterprises and the UN Guiding Principles on Business and Human Rights? Details:*

Not applicable

Principal adverse impacts are the most significant negative impacts of investment decisions on sustainability factors relating to environmental, social and employee matters, respect for human rights, anti-corruption and anti-bribery matters.



Does this financial product consider principal adverse impacts on sustainability factors?

Yes

No

The Management Company has joined the Net Zero Asset Manager Initiative and considers PAI indicators through stewardship including engagement, both are relevant to mitigate potential adverse impact as a company.

Due to the commitment to the Net Zero Asset Manager Initiative, the Management Company aims to reduce greenhouse gas emissions in partnership with asset owner clients on decarbonisation goals, consistent with an ambition to reach net zero emission by 2050 or sooner across all assets under management. As part of this objective the Management Company will set an interim target for the proportion of assets to be managed in line with the attainment of net zero emissions by 2050 or sooner.

The Sub-Fund's Investment Manager addresses PAI indicators regarding greenhouse gas emission, biodiversity, water, waste as well as social and employee matters for corporate issuers, and, where relevant, the freedom house index is applied to investments in sovereigns. PAI indicators are considered within the Investment Manager's investment process through the means of exclusions as described in the "binding elements" section of the Sub-Fund.

The data coverage for the data required for the PAI indicators is heterogenous. The data coverage related to biodiversity, water and waste is low and the related PAI indicators are considered through exclusion of securities issued by companies having a severe violation / breach of principles and guidelines such as the Principles of the United Nations Global Compact, the OECD Guidelines for Multinational Enterprises, and the United Nations Guiding Principles for Business and Human Rights on the grounds of problematic practices around human rights, labour rights, environment, and corruption issues. Therefore, the Investment Manager will strive to increase data coverage for PAI indicators with low data coverage. The Investment Manager will regularly evaluate whether the availability of data has increased sufficiently to potentially include assessment of such data in the investment process.

Additionally, the Investment manager considers GHG related PAI indicators by outperforming the Weighted Average GHG Intensity against its benchmark.

The following PAI indicators are considered:

Applicable to corporate issuers

- GHG Emissions
- Carbon footprint
- GHG Intensity of investee companies
- Exposure to companies active in the fossil fuel sector
- Activities negatively affecting biodiversity-sensitive areas
- Emissions to water
- Hazardous waste ratio
- Violation of UN Global compact principles
- Lack of processes and compliance mechanisms to monitor compliance with UN Global Compact principles
- Board gender diversity
- Exposure to controversial weapons

Applicable to sovereign and supranational issuers

- Investee countries subject to social violations

The information on the PAI indicators will be available in the end-year report of the Sub-Fund.



What investment strategy does this financial product follow?

The investment strategy guides investment decisions based on factors such as investment objectives and risk tolerance.

Allianz Euroland Equity Growth's investment objective is to invest in the Equity Markets of the Eurozone with a focus on growth stocks in accordance with the Sustainability Key Performance Indicator Strategy (Relative) ("KPI Strategy (Relative)").

The Sub-Fund's strategy is to outperform the Weighted Average GHG Intensity against its benchmark. The outperformance is determined as the excess between the Sub-Fund's weighted average GHG Intensity and the Sub-Fund's benchmark Weighted Average GHG Intensity.

The weighted average GHG Intensity is the weighted average of the Sub-Fund's GHG Intensity (in tCO₂e per Millions of sales). Sales represent company's annual sales. This ratio of GHG normalized by Sales facilitates comparison between companies of different sizes. The ratio is in tCO₂e per Millions of sales. The metric allows comparing weighted average GHG Intensities of different portfolios to identify portfolios comprised of more GHG-efficient issuers in terms of the issuer's sales. The portfolio weights (and benchmark or universe weights) are rebased such that only issuers with GHG emissions data available are considered in the calculation. GHG represents a respective issuer's greenhouse gas emissions. To determine the GHG Intensity of a company issuer, GHG Intensity data from third party data providers will be used. The GHG intensity is analysed by the Investment Manager and is considered within the securities selection process in order to meet the Sub-Fund Investment objective.

The proportion of assets which do not have a GHG intensity assessment is expected to be low. Examples of instruments not having a GHG intensity assessment are cash and deposits, some Target Funds, and investments for which the GHG intensity is deemed to be not appropriate and/or data is not available.

The Sub-Fund's general investment approach (Sub-Fund's applicable General Asset Class Principles in combination with its individual investment restrictions) is described in the prospectus.

● What are the binding elements of the investment strategy used to select the investments to attain each of the environmental or social characteristics promoted by this financial product?

The binding elements are:

- Min. 80% KPI coverage of the Sub-Fund's Portfolio (Portfolio in this respect does not comprise derivatives and instruments that are non-evaluated by nature (e. g., cash and deposits)).
- Min. 20% outperformance of benchmark in terms of Weighted Average GHG Intensity.

- Application of the following sustainable minimum exclusion criteria for direct investments:
- securities issued by companies having a severe violation / breach of principles and guidelines such as the Principles of the United Nations Global Compact, the OECD Guidelines for Multinational Enterprises, and the United Nations Guiding Principles for Business and Human Rights on the grounds of problematic practices around human rights, labour rights, environment, and corruption,
- securities issued by companies involved in controversial weapons (anti-personnel mines, cluster munitions, chemical weapons, biological weapons, depleted uranium, white phosphorus, and nuclear weapons),
- securities issued by companies that derive more than 10% of their revenues from weapons, military equipment, and services,
- securities issued by companies that derive more than 10% of their revenue from thermal coal extraction
- securities issued by utility companies that generate more than 20% of their revenues from coal,
- securities issued by companies involved in the production of tobacco, and securities issued by companies involved in the distribution of tobacco with more than 5% of their revenues.

Direct investments in sovereign issuers with an insufficient freedom house index score are excluded.

The sustainable minimum exclusion criteria are based on information from an external data provider and coded in pre- and post-trade compliance. The review is performed at least half yearly.

● **What is the committed minimum rate to reduce the scope of the investments considered prior to the application of that investment strategy?**

The Sub-Fund does not commit to reduce the scope of the investments by a certain minimum rate.

● **What is the policy to assess good governance practices of the investee companies?**

Good governance principles are considered by screening out companies based on their involvement in controversies around international norms corresponding to the four good governance practices: sound management structures, employee relations, remuneration of staff and tax compliance. Companies having a severe violation in either of those areas will not be investible. For certain cases, flagged issuers shall be on a watch list. These companies will appear on this watch list when the Investment Manager believes that engagement may lead to improvements or when the company is assessed to take remedial actions. Companies on the watch list remain investible unless the Investment Manager believes that the engagement or the remedial actions of the company does not lead to the desired remedy of the severe controversy.

In addition, the Sub-Fund's Investment Manager is committed to actively encourage open dialogues with investee companies on corporate governance, proxy voting and broader sustainability issues in advance of shareholder meetings (regularly for direct investments in shares). The Sub-Fund's Investment Manager's approach to proxy voting and company engagement is set out in the Management Company's Stewardship Statement.

Good governance practices include sound management structures, employee relations, remuneration of staff and tax compliance.



What is the asset allocation planned for this financial product?

Asset allocation describes the share of investments in specific assets.

Min. 80% of the Sub-Funds' assets (excluding cash, and derivatives) are used to meet the environmental or social characteristics promoted by this Sub-Fund. A low portion of the Sub-Fund might contain assets which do not promote environmental or social characteristics. Example of such instruments are derivatives, cash and deposits, some Target Funds and investment with temporarily divergent or absent environmental, social, or good governance qualifications.

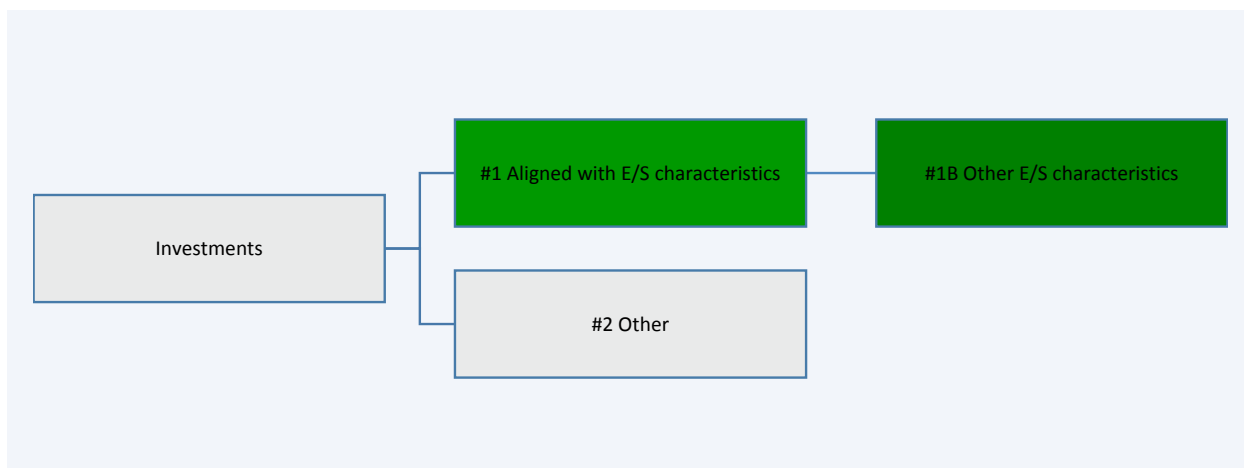

#1 Aligned with E/S characteristics includes the investments of the financial product used to attain the environmental or social characteristics promoted by the financial product.

#2 Other includes the remaining investments of the financial product which are neither aligned with the environmental or social characteristics, nor are qualified as sustainable investments.

The category **#1 Aligned with E/S characteristics** covers:

- The sub-category **#1A Sustainable** covers sustainable investments with environmental or social objectives.
- The sub-category **#1B Other E/S characteristics** covers investments aligned with the environmental or social characteristics that do not qualify as sustainable investments.

- **How does the use of derivatives attain the environmental or social characteristics promoted by the financial product?**

Not applicable



To what minimum extent are sustainable investments with an environmental objective aligned with the EU Taxonomy?

The Sub-Fund's Investment Manager does not commit to a minimum share of sustainable investments with an environmental objective aligned with the EU Taxonomy.

- **Does the financial product invest in fossil gas and/or nuclear energy related activities that comply with the EU Taxonomy ¹?**

- Yes:
 - In fossil gas In nuclear energy
- No

Taxonomy-aligned activities are expressed as a share of:

- **turnover** reflecting the share of revenue from green activities of investee companies
- **capital expenditure** (CapEx) showing the green investments made by investee companies, e.g. for a transition to a green economy.
- **operational expenditure** (OpEx) reflecting green operational activities of investee companies.

¹ Fossil gas and/or nuclear related activities will only comply with the EU Taxonomy where they contribute to limiting climate change ("climate change mitigation") and do not significantly harm any EU Taxonomy objective - see explanatory note in the left hand margin. The full criteria for fossil gas and nuclear energy economic activities that comply with the EU Taxonomy are laid down in Commission Delegated Regulation (EU) 2022/1214.

The two graphs below show in green the minimum percentage of investments that are aligned with the EU Taxonomy. As there is no appropriate methodology to determine the Taxonomy-alignment of sovereign bonds*, the first graph shows the Taxonomy-alignment in relation to all the investments of the financial product including sovereign bonds, while the second graph shows the Taxonomy-alignment only in relation to the investments of the financial product other than sovereign bonds.

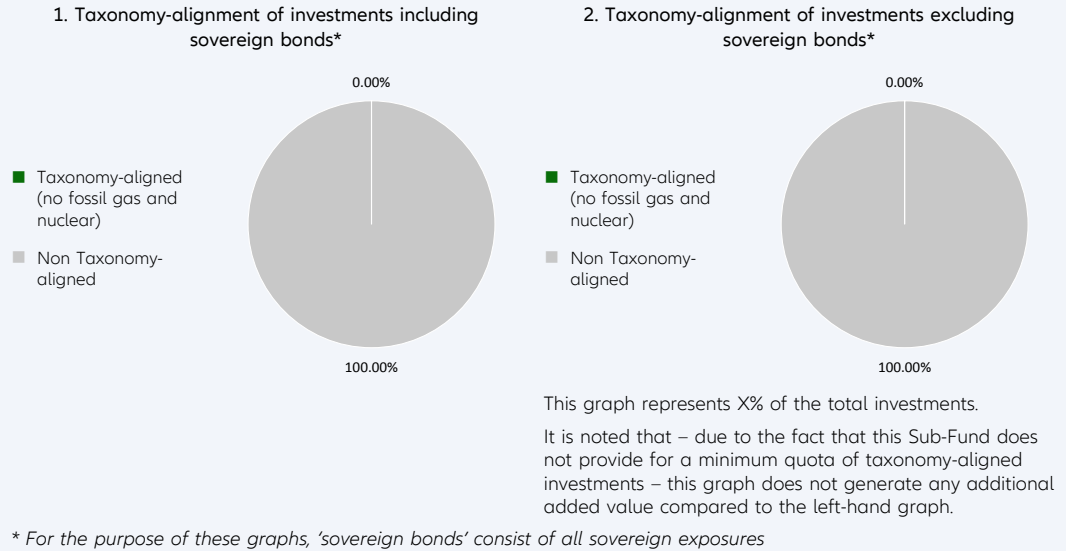

Enabling activities directly enable other activities to make a substantial contribution to an environmental objective.

Transitional activities are activities for which low-carbon alternatives are not yet available and among others have greenhouse gas emission levels corresponding to the best performance.

● **What is the minimum share of investments in transitional and enabling activities?**

The Sub-Fund’s Investment Manager does not commit to a split of minimum taxonomy alignment into transitional, enabling activities and own performance.



What is the minimum share of sustainable investments with an environmental objective that are not aligned with the EU Taxonomy?

The Sub-Fund’s Investment Manager does not commit to a minimum share of investments with an environmental objective that are not aligned with the EU Taxonomy.

 are sustainable investments with an environmental objective that **do not take into account the criteria** for environmentally sustainable economic activities under the EU Taxonomy.



What is the minimum share of socially sustainable investments?

The Sub-Fund’s Investment Manager does not commit to a minimum share of socially sustainable investments.



What investments are included under “#2 Other”, what is their purpose and are there any minimum environmental or social safeguards?

Under “#2 Other” investments into cash, Target Funds, or derivatives can be included. Derivatives might be used for efficient portfolio management (including risk hedging) and/or investment purposes, and Target Funds to benefit from a specific strategy. For those investments no environmental or social safeguards are applied.



Is a specific index designated as a reference benchmark to determine whether this financial product is aligned with the environmental and/or social characteristics that it promotes?

Yes, the Sub-Fund has assigned the S&P Eurozone Large Mid Cap Growth Total Return Net as a benchmark. This benchmark is a market index. The Sub-Fund will promote environmental and social characteristics by outperforming the benchmark's Weighted Average GHG Intensity

Reference benchmarks are indexes to measure whether the financial product attains the environmental or social characteristics that they promote.

- **How is the reference benchmark continuously aligned with each of the environmental or social characteristics promoted by the financial product?**

The benchmark is a market index and does not incorporate environmental or social characteristics for index construction.

- **How is the alignment of the investment strategy with the methodology of the index ensured on a continuous basis?**

The benchmark is not continuously aligned as it does not incorporate environmental or social characteristics for index construction.

- **How does the designated index differ from a relevant broad market index?**

The benchmark is a broad market index.

- **Where can the methodology used for the calculation of the designated index be found?**

Details of the Benchmark's methodology may be found at <https://www.spglobal.com/spdji/en/documents/methodologies/methodology-sp-global-bmi-sp-ifci-indices.pdf> or at www.spglobal.com



Where can I find more product specific information online?

More product-specific information can be found on the website: <https://regulatory.allianzgi.com/SFDR>

Template pre-contractual disclosure for the financial products referred to in Article 8, paragraphs 1, 2 and 2a, of Regulation (EU) 2019/2088 and Article 6, first paragraph, of Regulation (EU) 2020/852

Product name:

Allianz Europe Equity Growth

Legal entity identifier: 549300N3S28ICP3HG051

Environmental and/or social characteristics

Sustainable investment means an investment in an economic activity that contributes to an environmental or social objective, provided that the investment does not significantly harm any environmental or social objective and that the investee companies follow good governance practices.

The EU Taxonomy is a classification system laid down in Regulation (EU) 2020/852, establishing a list of **environmentally sustainable economic activities**. That Regulation does not include a list of socially sustainable economic activities. Sustainable investments with an environmental objective might be aligned with the Taxonomy or not.

Does this financial product have a sustainable investment objective?

Yes

No

It will make a minimum of **sustainable investments with an environmental objective**: ___%

in economic activities that qualify as environmentally sustainable under the EU Taxonomy

in economic activities that do not qualify as environmentally sustainable under the EU Taxonomy

It will make a minimum of **sustainable investments with a social objective** ___%

It **promotes Environmental/Social (E/S) characteristics** and while it does not have as its objective a sustainable investment, it will have a minimum proportion of ___% of sustainable investments

with an environmental objective in economic activities that qualify as environmentally sustainable under the EU Taxonomy

with an environmental objective in economic activities that do not qualify as environmentally sustainable under the EU Taxonomy

with a social objective

It promotes E/S characteristics, but **will not make any sustainable investments**



What environmental and/or social characteristics are promoted by this financial product?

Allianz Europe Equity Growth (the "Sub-Fund") is managed according to the Sustainability Key Performance Indicator Strategy (Relative) ("KPI Strategy (Relative)") which addresses greenhouse gas (GHG) Intensity. The "Sustainability KPI" measures the GHG Intensity defined by the weighted average intensity of greenhouse gas emissions based on company's annual sales ("GHG Intensity").

GHG Intensity will be addressed by outperforming the Weighted Average GHG Intensity against its benchmark.

In addition, sustainable minimum exclusion criteria apply.

A reference benchmark has been designated for the purpose of attaining the environmental and/or social characteristics promoted by the Sub-Fund.

● What sustainability indicators are used to measure the attainment of each of the environmental or social characteristics promoted by this financial product?

To measure the attainment of the environmental and/or social characteristics the following sustainability indicators are used and reported on, at the fiscal year end:

- The actual percentage of KPI coverage of the Sub-Fund's Portfolio (Portfolio in this respect does not comprise derivatives and instruments that are non-evaluated by nature (e. g., cash and deposits)).
- The actual weighted average GHG Intensity portfolio vs weighted average GHG Intensity of the benchmark.

Sustainability indicators measure how the environmental or social characteristics promoted by the financial product are attained.

- Confirmation that Principal Adverse Impacts (PAIs) of investment decisions on sustainability factors are considered through the application of exclusion criteria.

- **What are the objectives of the sustainable investments that the financial product partially intends to make and how does the sustainable investment contribute to such objectives?**

Not applicable

- **How do the sustainable investments that the financial product partially intends to make, not cause significant harm to any environmental or social sustainable investment objective?**

Not applicable

- *How have the indicators for adverse impacts on sustainability factors been taken into account?*

Not applicable

- *How are the sustainable investments aligned with the OECD Guidelines for Multinational Enterprises and the UN Guiding Principles on Business and Human Rights? Details:*

Not applicable

Principal adverse impacts are the most significant negative impacts of investment decisions on sustainability factors relating to environmental, social and employee matters, respect for human rights, anti-corruption and anti-bribery matters.



Does this financial product consider principal adverse impacts on sustainability factors?

Yes

No

The Management Company has joined the Net Zero Asset Manager Initiative and considers PAI indicators through stewardship including engagement, both are relevant to mitigate potential adverse impact as a company.

Due to the commitment to the Net Zero Asset Manager Initiative, the Management Company aims to reduce greenhouse gas emissions in partnership with asset owner clients on decarbonisation goals, consistent with an ambition to reach net zero emission by 2050 or sooner across all assets under management. As part of this objective the Management Company will set an interim target for the proportion of assets to be managed in line with the attainment of net zero emissions by 2050 or sooner.

The Sub-Fund's Investment Manager addresses PAI indicators regarding greenhouse gas emission, biodiversity, water, waste as well as social and employee matters for corporate issuers, and, where relevant, the freedom house index is applied to investments in sovereigns. PAI indicators are considered within the Investment Manager's investment process through the means of exclusions as described in the "binding elements" section of the Sub-Fund.

The data coverage for the data required for the PAI indicators is heterogenous. The data coverage related to biodiversity, water and waste is low and the related PAI indicators are considered through exclusion of securities issued by companies having a severe violation / breach of principles and guidelines such as the Principles of the United Nations Global Compact, the OECD Guidelines for Multinational Enterprises, and the United Nations Guiding Principles for Business and Human Rights on the grounds of problematic practices around human rights, labour rights, environment, and corruption issues. Therefore, the Investment Manager will strive to increase data coverage for PAI indicators with low data coverage. The Investment Manager will regularly evaluate whether the availability of data has increased sufficiently to potentially include assessment of such data in the investment process.

Additionally, the Investment manager considers GHG related PAI indicators by outperforming the Weighted Average GHG Intensity against its benchmark.

The following PAI indicators are considered:

Applicable to corporate issuers

- GHG Emissions
- Carbon footprint
- GHG Intensity of investee companies
- Exposure to companies active in the fossil fuel sector
- Activities negatively affecting biodiversity-sensitive areas
- Emissions to water
- Hazardous waste ratio
- Violation of UN Global compact principles
- Lack of processes and compliance mechanisms to monitor compliance with UN Global Compact principles
- Board gender diversity
- Exposure to controversial weapons

Applicable to sovereign and supranational issuers

- Investee countries subject to social violations

The information on the PAI indicators will be available in the end-year report of the Sub-Fund.



What investment strategy does this financial product follow?

The investment strategy guides investment decisions based on factors such as investment objectives and risk tolerance.

Allianz Europe Equity Growth's investment objective is to invest in European Equity Markets with a focus on growth stocks in accordance with the Sustainability Key Performance Indicator Strategy (Relative) ("KPI Strategy (Relative)").

The Sub-Fund's strategy is to outperform the Weighted Average GHG Intensity against its benchmark. The outperformance is determined as the excess between the Sub-Fund's weighted average GHG Intensity and the Sub-Fund's benchmark Weighted Average GHG Intensity.

The weighted average GHG Intensity is the weighted average of the Sub-Fund's GHG Intensity (in tCO₂e per Millions of sales). Sales represent company's annual sales. This ratio of GHG normalized by Sales facilitates comparison between companies of different sizes. The ratio is in tCO₂e per Millions of sales. The metric allows comparing weighted average GHG Intensities of different portfolios to identify portfolios comprised of more GHG-efficient issuers in terms of the issuer's sales. The portfolio weights (and benchmark or universe weights) are rebased such that only issuers with GHG emissions data available are considered in the calculation. GHG represents a respective issuer's greenhouse gas emissions. To determine the GHG Intensity of a company issuer, GHG Intensity data from third party data providers will be used. The GHG intensity is analysed by the Investment Manager and is considered within the securities selection process in order to meet the Sub-Fund Investment objective.

The proportion of assets which do not have a GHG intensity assessment is expected to be low. Examples of instruments not having a GHG intensity assessment are cash and deposits, some Target Funds, and investments for which the GHG intensity is deemed to be not appropriate and/or data is not available.

The Sub-Fund's general investment approach (Sub-Fund's applicable General Asset Class Principles in combination with its individual investment restrictions) is described in the prospectus.

● What are the binding elements of the investment strategy used to select the investments to attain each of the environmental or social characteristics promoted by this financial product?

The binding elements are:

- Min. 80% KPI coverage of the Sub-Fund's Portfolio (Portfolio in this respect does not comprise derivatives and instruments that are non-evaluated by nature (e. g., cash and deposits)).
- Min. 20% outperformance of benchmark in terms of Weighted Average GHG Intensity.

- Application of the following sustainable minimum exclusion criteria for direct investments:
- securities issued by companies having a severe violation / breach of principles and guidelines such as the Principles of the United Nations Global Compact, the OECD Guidelines for Multinational Enterprises, and the United Nations Guiding Principles for Business and Human Rights on the grounds of problematic practices around human rights, labour rights, environment, and corruption,
- securities issued by companies involved in controversial weapons (anti-personnel mines, cluster munitions, chemical weapons, biological weapons, depleted uranium, white phosphorus, and nuclear weapons),
- securities issued by companies that derive more than 10% of their revenues from weapons, military equipment, and services,
- securities issued by companies that derive more than 10% of their revenue from thermal coal extraction,
- securities issued by utility companies that generate more than 20% of their revenues from coal,
- securities issued by companies involved in the production of tobacco, and securities issued by companies involved in the distribution of tobacco with more than 5% of their revenues.

Direct investments in sovereign issuers with an insufficient freedom house index score are excluded.

The sustainable minimum exclusion criteria are based on information from an external data provider and coded in pre- and post-trade compliance. The review is performed at least half yearly.

● **What is the committed minimum rate to reduce the scope of the investments considered prior to the application of that investment strategy?**

The Sub-Fund does not commit to reduce the scope of the investments by a certain minimum rate.

● **What is the policy to assess good governance practices of the investee companies?**

Good governance principles are considered by screening out companies based on their involvement in controversies around international norms corresponding to the four good governance practices: sound management structures, employee relations, remuneration of staff and tax compliance. Companies having a severe violation in either of those areas will not be investible. For certain cases, flagged issuers shall be on a watch list. These companies will appear on this watch list when the Investment Manager believes that engagement may lead to improvements or when the company is assessed to take remedial actions. Companies on the watch list remain investible unless the Investment Manager believes that the engagement or the remedial actions of the company does not lead to the desired remedy of the severe controversy.

In addition, the Sub-Fund's Investment Manager is committed to actively encourage open dialogues with investee companies on corporate governance, proxy voting and broader sustainability issues in advance of shareholder meetings (regularly for direct investments in shares). The Sub-Fund's Investment Manager's approach to proxy voting and company engagement is set out in the Management Company's Stewardship Statement.

Good governance practices include sound management structures, employee relations, remuneration of staff and tax compliance.



What is the asset allocation planned for this financial product?

Asset allocation describes the share of investments in specific assets.

Min. 80% of the Sub-Funds' assets (excluding cash, and derivatives) are used to meet the environmental or social characteristics promoted by this Sub-Fund. A low portion of the Sub-Fund might contain assets which do not promote environmental or social characteristics. Example of such instruments are derivatives, cash and deposits, some Target Funds and investment with temporarily divergent or absent environmental, social, or good governance qualifications.

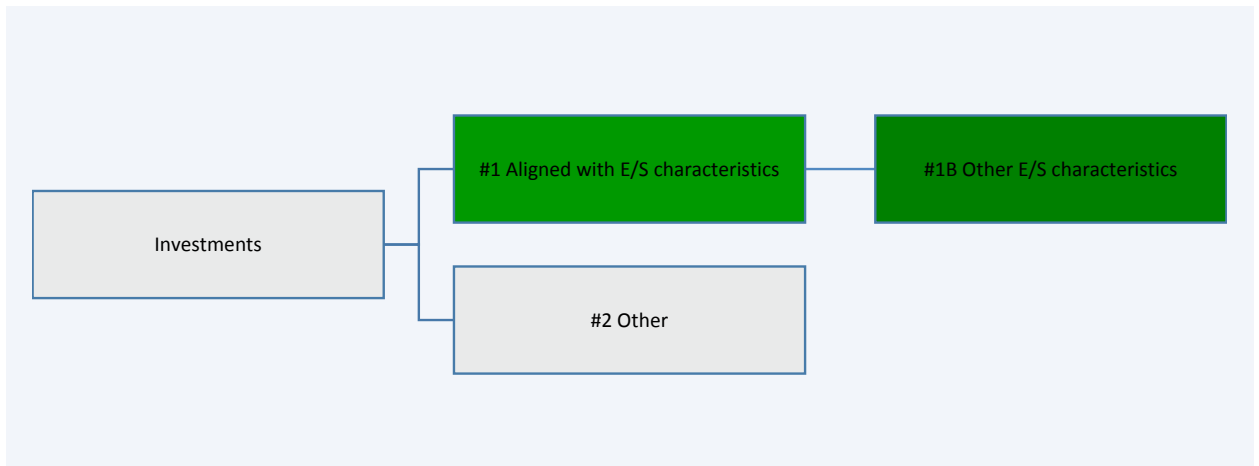

#1 Aligned with E/S characteristics includes the investments of the financial product used to attain the environmental or social characteristics promoted by the financial product.

#2 Other includes the remaining investments of the financial product which are neither aligned with the environmental or social characteristics, nor are qualified as sustainable investments.

The category **#1 Aligned with E/S characteristics** covers:

- The sub-category **#1A Sustainable** covers sustainable investments with environmental or social objectives.
- The sub-category **#1B Other E/S characteristics** covers investments aligned with the environmental or social characteristics that do not qualify as sustainable investments.

- **How does the use of derivatives attain the environmental or social characteristics promoted by the financial product?**

Not applicable



To what minimum extent are sustainable investments with an environmental objective aligned with the EU Taxonomy?

The Sub-Fund's Investment Manager does not commit to a minimum share of sustainable investments with an environmental objective aligned with the EU Taxonomy.

- **Does the financial product invest in fossil gas and/or nuclear energy related activities that comply with the EU Taxonomy¹?**

Yes:

In fossil gas In nuclear energy

No

Taxonomy-aligned activities are expressed as a share of:

- **turnover** reflecting the share of revenue from green activities of investee companies
- **capital expenditure** (CapEx) showing the green investments made by investee companies, e.g. for a transition to a green economy.
- **operational expenditure** (OpEx) reflecting green operational activities of investee companies.

¹ Fossil gas and/or nuclear related activities will only comply with the EU Taxonomy where they contribute to limiting climate change ("climate change mitigation") and do not significantly harm any EU Taxonomy objective - see explanatory note in the left hand margin. The full criteria for fossil gas and nuclear energy economic activities that comply with the EU Taxonomy are laid down in Commission Delegated Regulation (EU) 2022/1214.

The two graphs below show in green the minimum percentage of investments that are aligned with the EU Taxonomy. As there is no appropriate methodology to determine the Taxonomy-alignment of sovereign bonds*, the first graph shows the Taxonomy-alignment in relation to all the investments of the financial product including sovereign bonds, while the second graph shows the Taxonomy-alignment only in relation to the investments of the financial product other than sovereign bonds.

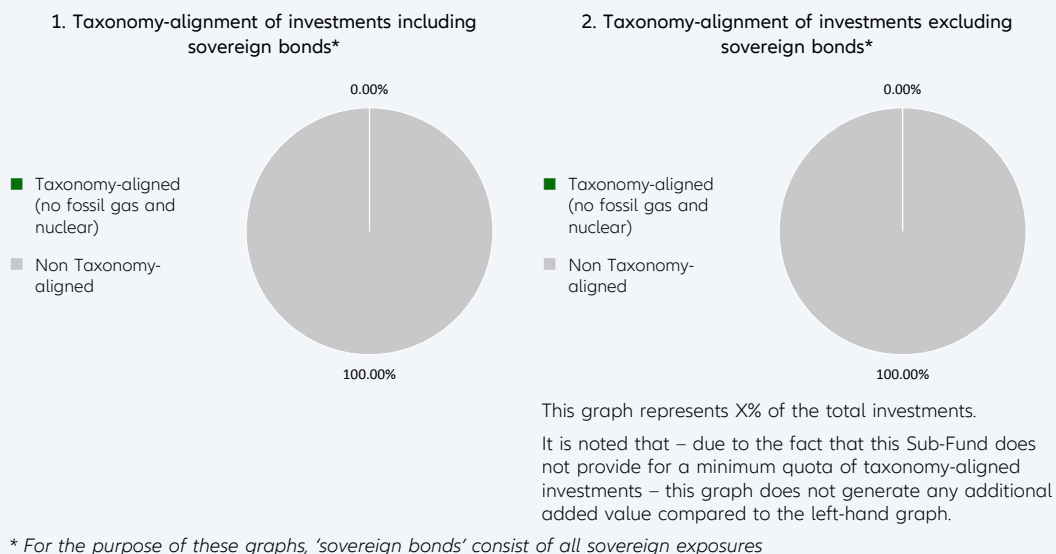

Enabling activities directly enable other activities to make a substantial contribution to an environmental objective.

Transitional activities are activities for which low-carbon alternatives are not yet available and among others have greenhouse gas emission levels corresponding to the best performance.

● **What is the minimum share of investments in transitional and enabling activities?**

The Sub-Fund's Investment Manager does not commit to a split of minimum taxonomy alignment into transitional, enabling activities and own performance.



What is the minimum share of sustainable investments with an environmental objective that are not aligned with the EU Taxonomy?

The Sub-Fund's Investment Manager does not commit to a minimum share of investments with an environmental objective that are not aligned with the EU Taxonomy.



are sustainable investments with an environmental objective that **do not take into account the criteria** for environmentally sustainable economic activities under the EU Taxonomy.



What is the minimum share of socially sustainable investments?

The Sub-Fund's Investment Manager does not commit to a minimum share of socially sustainable investments.



What investments are included under “#2 Other”, what is their purpose and are there any minimum environmental or social safeguards?

Under “#2 Other” investments into cash, Target Funds, or derivatives can be included. Derivatives might be used for efficient portfolio management (including risk hedging) and/or investment purposes, and Target Funds to benefit from a specific strategy. For those investments no environmental or social safeguards are applied.



Is a specific index designated as a reference benchmark to determine whether this financial product is aligned with the environmental and/or social characteristics that it promotes?

Yes, the Sub-Fund has assigned the S&P Europe Large Mid Cap Growth Total Return Net as a benchmark. This benchmark is a market index. The Sub-Fund will promote environmental and social characteristics by outperforming the benchmark's Weighted Average GHG Intensity

Reference benchmarks are indexes to measure whether the financial product attains the environmental or social characteristics that they promote.

- **How is the reference benchmark continuously aligned with each of the environmental or social characteristics promoted by the financial product?**

The benchmark is a market index and does not incorporate environmental or social characteristics for index construction.

- **How is the alignment of the investment strategy with the methodology of the index ensured on a continuous basis?**

The benchmark is not continuously aligned as it does not incorporate environmental or social characteristics for index construction.

- **How does the designated index differ from a relevant broad market index?**

The benchmark is a broad market index.

- **Where can the methodology used for the calculation of the designated index be found?**

Details of the Benchmark's methodology may be found at <https://www.spglobal.com/spdji/en/documents/methodologies/methodology-sp-global-bmi-sp-ifci-indices.pdf> or at www.spglobal.com



Where can I find more product specific information online?

More product-specific information can be found on the website: <https://regulatory.allianzgi.com/SFDR>

Template pre-contractual disclosure for the financial products referred to in Article 8, paragraphs 1, 2 and 2a, of Regulation (EU) 2019/2088 and Article 6, first paragraph, of Regulation (EU) 2020/852

Product name:

Allianz Europe Equity Growth Select

Legal entity identifier: 549300UEVM0IKP1RGZ24

Environmental and/or social characteristics

Sustainable investment means an investment in an economic activity that contributes to an environmental or social objective, provided that the investment does not significantly harm any environmental or social objective and that the investee companies follow good governance practices.

The **EU Taxonomy** is a classification system laid down in Regulation (EU) 2020/852, establishing a list of **environmentally sustainable economic activities**. That Regulation does not include a list of socially sustainable economic activities. Sustainable investments with an environmental objective might be aligned with the Taxonomy or not.

Does this financial product have a sustainable investment objective?	
Yes	No
<input type="checkbox"/> It will make a minimum of sustainable investments with an environmental objective : ___% <input type="checkbox"/> in economic activities that qualify as environmentally sustainable under the EU Taxonomy <input type="checkbox"/> in economic activities that do not qualify as environmentally sustainable under the EU Taxonomy	<input type="checkbox"/> It promotes Environmental/Social (E/S) characteristics and while it does not have as its objective a sustainable investment, it will have a minimum proportion of ___% of sustainable investments <input type="checkbox"/> with an environmental objective in economic activities that qualify as environmentally sustainable under the EU Taxonomy <input type="checkbox"/> with an environmental objective in economic activities that do not qualify as environmentally sustainable under the EU Taxonomy <input type="checkbox"/> with a social objective
<input type="checkbox"/> It will make a minimum of sustainable investments with a social objective ___%	<input checked="" type="checkbox"/> It promotes E/S characteristics, but will not make any sustainable investments



What environmental and/or social characteristics are promoted by this financial product?

Allianz Europe Equity Growth Select (the "Sub-Fund") is managed according to the Sustainability Key Performance Indicator Strategy (Relative) ("KPI Strategy (Relative)") which addresses greenhouse gas (GHG) Intensity. The "Sustainability KPI" measures the GHG Intensity defined by the weighted average intensity of greenhouse gas emissions based on company's annual sales ("GHG Intensity").

GHG Intensity will be addressed by outperforming the Weighted Average GHG Intensity against its benchmark.

In addition, sustainable minimum exclusion criteria apply.

A reference benchmark has been designated for the purpose of attaining the environmental and/or social characteristics promoted by the Sub-Fund.

What sustainability indicators are used to measure the attainment of each of the environmental or social characteristics promoted by this financial product?

To measure the attainment of the environmental and/or social characteristics the following sustainability indicators are used and reported on, at the fiscal year end:

- The actual percentage of KPI coverage of the Sub-Fund's Portfolio (Portfolio in this respect does not comprise derivatives and instruments that are non-evaluated by nature (e. g., cash and deposits)).
- The actual weighted average GHG Intensity portfolio vs weighted average GHG Intensity of the benchmark.

Sustainability indicators measure how the environmental or social characteristics promoted by the financial product are attained.

- Confirmation that Principal Adverse Impacts (PAIs) of investment decisions on sustainability factors are considered through the application of exclusion criteria.

- **What are the objectives of the sustainable investments that the financial product partially intends to make and how does the sustainable investment contribute to such objectives?**

Not applicable

- **How do the sustainable investments that the financial product partially intends to make, not cause significant harm to any environmental or social sustainable investment objective?**

Not applicable

- *How have the indicators for adverse impacts on sustainability factors been taken into account?*

Not applicable

- *How are the sustainable investments aligned with the OECD Guidelines for Multinational Enterprises and the UN Guiding Principles on Business and Human Rights? Details:*

Not applicable

Principal adverse impacts are the most significant negative impacts of investment decisions on sustainability factors relating to environmental, social and employee matters, respect for human rights, anti-corruption and anti-bribery matters.



Does this financial product consider principal adverse impacts on sustainability factors?

Yes

No

The Management Company has joined the Net Zero Asset Manager Initiative and considers PAI indicators through stewardship including engagement, both are relevant to mitigate potential adverse impact as a company.

Due to the commitment to the Net Zero Asset Manager Initiative, the Management Company aims to reduce greenhouse gas emissions in partnership with asset owner clients on decarbonisation goals, consistent with an ambition to reach net zero emission by 2050 or sooner across all assets under management. As part of this objective the Management Company will set an interim target for the proportion of assets to be managed in line with the attainment of net zero emissions by 2050 or sooner.

The Sub-Fund's Investment Manager addresses PAI indicators regarding greenhouse gas emission, biodiversity, water, waste as well as social and employee matters for corporate issuers, and, where relevant, the freedom house index is applied to investments in sovereigns. PAI indicators are considered within the Investment Manager's investment process through the means of exclusions as described in the "binding elements" section of the Sub-Fund.

The data coverage for the data required for the PAI indicators is heterogenous. The data coverage related to biodiversity, water and waste is low and the related PAI indicators are considered through exclusion of securities issued by companies having a severe violation / breach of principles and guidelines such as the Principles of the United Nations Global Compact, the OECD Guidelines for Multinational Enterprises, and the United Nations Guiding Principles for Business and Human Rights on the grounds of problematic practices around human rights, labour rights, environment, and corruption issues. Therefore, the Investment Manager will strive to increase data coverage for PAI indicators with low data coverage. The Investment Manager will regularly evaluate whether the availability of data has increased sufficiently to potentially include assessment of such data in the investment process.

Additionally, the Investment manager considers GHG related PAI indicators by outperforming the Weighted Average GHG Intensity against its benchmark.

The following PAI indicators are considered:

Applicable to corporate issuers

- GHG Emissions
- Carbon footprint
- GHG Intensity of investee companies
- Exposure to companies active in the fossil fuel sector
- Activities negatively affecting biodiversity-sensitive areas
- Emissions to water
- Hazardous waste ratio
- Violation of UN Global compact principles
- Lack of processes and compliance mechanisms to monitor compliance with UN Global Compact principles
- Board gender diversity
- Exposure to controversial weapons

Applicable to sovereign and supranational issuers

- Investee countries subject to social violations

The information on the PAI indicators will be available in the end-year report of the Sub-Fund.



What investment strategy does this financial product follow?

The investment strategy guides investment decisions based on factors such as investment objectives and risk tolerance.

Allianz Europe Equity Growth Select's investment objective is to invest in European Equity Markets with a focus on growth stocks of large market capitalization companies in accordance with the Sustainability Key Performance Indicator Strategy (Relative) ("KPI Strategy (Relative)").

The Sub-Fund's strategy is to outperform the Weighted Average GHG Intensity against its benchmark. The outperformance is determined as the excess between the Sub-Fund's weighted average GHG Intensity and the Sub-Fund's benchmark Weighted Average GHG Intensity.

The weighted average GHG Intensity is the weighted average of the Sub-Fund's GHG Intensity (in tCO₂e per Millions of sales). Sales represent company's annual sales. This ratio of GHG normalized by Sales facilitates comparison between companies of different sizes. The ratio is in tCO₂e per Millions of sales. The metric allows comparing weighted average GHG Intensities of different portfolios to identify portfolios comprised of more GHG-efficient issuers in terms of the issuer's sales. The portfolio weights (and benchmark or universe weights) are rebased such that only issuers with GHG emissions data available are considered in the calculation. GHG represents a respective issuer's greenhouse gas emissions. To determine the GHG Intensity of a company issuer, GHG Intensity data from third party data providers will be used. The GHG intensity is analysed by the Investment Manager and is considered within the securities selection process in order to meet the Sub-Fund Investment objective.

The proportion of assets which do not have a GHG intensity assessment is expected to be low. Examples of instruments not having a GHG intensity assessment are cash and deposits, some Target Funds, and investments for which the GHG intensity is deemed to be not appropriate and/or data is not available.

The Sub-Fund's general investment approach (Sub-Fund's applicable General Asset Class Principles in combination with its individual investment restrictions) is described in the prospectus.

● What are the binding elements of the investment strategy used to select the investments to attain each of the environmental or social characteristics promoted by this financial product?

The binding elements are:

- Min. 80% KPI coverage of the Sub-Fund's Portfolio (Portfolio in this respect does not comprise derivatives and instruments that are non-evaluated by nature (e. g., cash and deposits)).
- Min. 20% outperformance of benchmark in terms of Weighted Average GHG Intensity.

- Application of the following sustainable minimum exclusion criteria for direct investments:
- securities issued by companies having a severe violation / breach of principles and guidelines such as the Principles of the United Nations Global Compact, the OECD Guidelines for Multinational Enterprises, and the United Nations Guiding Principles for Business and Human Rights on the grounds of problematic practices around human rights, labour rights, environment, and corruption,
- securities issued by companies involved in controversial weapons (anti-personnel mines, cluster munitions, chemical weapons, biological weapons, depleted uranium, white phosphorus, and nuclear weapons),
- securities issued by companies that derive more than 10% of their revenues from weapons, military equipment, and services,
- securities issued by companies that derive more than 10% of their revenue from thermal coal extraction
- securities issued by utility companies that generate more than 20% of their revenues from coal,
- securities issued by companies involved in the production of tobacco, and securities issued by companies involved in the distribution of tobacco with more than 5% of their revenues.

Direct investments in sovereign issuers with an insufficient freedom house index score are excluded.

The sustainable minimum exclusion criteria are based on information from an external data provider and coded in pre- and post-trade compliance. The review is performed at least half yearly.

● **What is the committed minimum rate to reduce the scope of the investments considered prior to the application of that investment strategy?**

The Sub-Fund does not commit to reduce the scope of the investments by a certain minimum rate.

● **What is the policy to assess good governance practices of the investee companies?**

Good governance principles are considered by screening out companies based on their involvement in controversies around international norms corresponding to the four good governance practices: sound management structures, employee relations, remuneration of staff and tax compliance. Companies having a severe violation in either of those areas will not be investible. For certain cases, flagged issuers shall be on a watch list. These companies will appear on this watch list when the Investment Manager believes that engagement may lead to improvements or when the company is assessed to take remedial actions. Companies on the watch list remain investible unless the Investment Manager believes that the engagement or the remedial actions of the company does not lead to the desired remedy of the severe controversy.

In addition, the Sub-Fund's Investment Manager is committed to actively encourage open dialogues with investee companies on corporate governance, proxy voting and broader sustainability issues in advance of shareholder meetings (regularly for direct investments in shares). The Sub-Fund's Investment Manager's approach to proxy voting and company engagement is set out in the Management Company's Stewardship Statement.

Good governance practices include sound management structures, employee relations, remuneration of staff and tax compliance.



What is the asset allocation planned for this financial product?

Asset allocation describes the share of investments in specific assets.

Min. 80% of the Sub-Funds' assets (excluding cash, and derivatives) are used to meet the environmental or social characteristics promoted by this Sub-Fund. A low portion of the Sub-Fund might contain assets which do not promote environmental or social characteristics. Example of such instruments are derivatives, cash and deposits, some Target Funds and investment with temporarily divergent or absent environmental, social, or good governance qualifications.

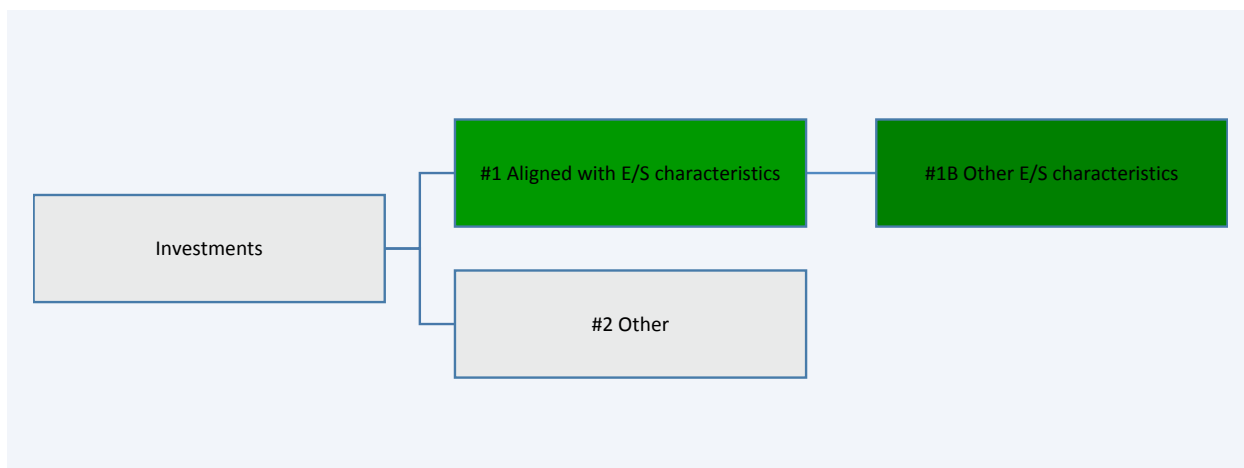

#1 Aligned with E/S characteristics includes the investments of the financial product used to attain the environmental or social characteristics promoted by the financial product.

#2 Other includes the remaining investments of the financial product which are neither aligned with the environmental or social characteristics, nor are qualified as sustainable investments.

The category **#1 Aligned with E/S characteristics** covers:

- The sub-category **#1A Sustainable** covers sustainable investments with environmental or social objectives.
- The sub-category **#1B Other E/S characteristics** covers investments aligned with the environmental or social characteristics that do not qualify as sustainable investments.

- **How does the use of derivatives attain the environmental or social characteristics promoted by the financial product?**

Not applicable



To what minimum extent are sustainable investments with an environmental objective aligned with the EU Taxonomy?

The Sub-Fund's Investment Manager does not commit to a minimum share of sustainable investments with an environmental objective aligned with the EU Taxonomy.

- **Does the financial product invest in fossil gas and/or nuclear energy related activities that comply with the EU Taxonomy¹?**

- Yes:
 - In fossil gas In nuclear energy
- No

Taxonomy-aligned activities are expressed as a share of:

- **turnover** reflecting the share of revenue from green activities of investee companies
- **capital expenditure** (CapEx) showing the green investments made by investee companies, e.g. for a transition to a green economy.
- **operational expenditure** (OpEx) reflecting green operational activities of investee companies.

¹ Fossil gas and/or nuclear related activities will only comply with the EU Taxonomy where they contribute to limiting climate change ("climate change mitigation") and do not significantly harm any EU Taxonomy objective - see explanatory note in the left hand margin. The full criteria for fossil gas and nuclear energy economic activities that comply with the EU Taxonomy are laid down in Commission Delegated Regulation (EU) 2022/1214.

The two graphs below show in green the minimum percentage of investments that are aligned with the EU Taxonomy. As there is no appropriate methodology to determine the Taxonomy-alignment of sovereign bonds*, the first graph shows the Taxonomy-alignment in relation to all the investments of the financial product including sovereign bonds, while the second graph shows the Taxonomy-alignment only in relation to the investments of the financial product other than sovereign bonds.

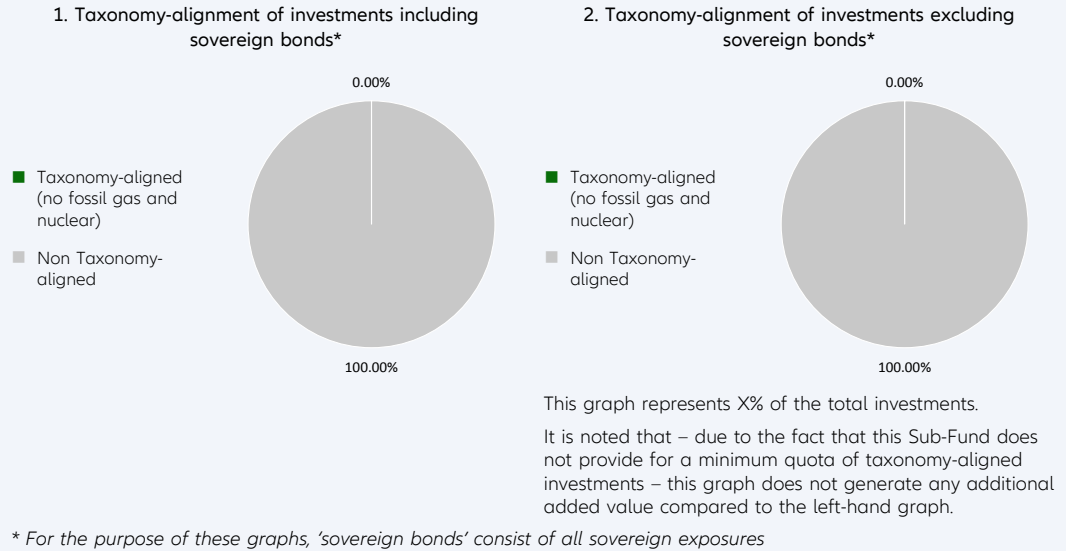

Enabling activities directly enable other activities to make a substantial contribution to an environmental objective.

Transitional activities are activities for which low-carbon alternatives are not yet available and among others have greenhouse gas emission levels corresponding to the best performance.

● **What is the minimum share of investments in transitional and enabling activities?**

The Sub-Fund’s Investment Manager does not commit to a split of minimum taxonomy alignment into transitional, enabling activities and own performance.



What is the minimum share of sustainable investments with an environmental objective that are not aligned with the EU Taxonomy?

The Sub-Fund’s Investment Manager does not commit to a minimum share of investments with an environmental objective that are not aligned with the EU Taxonomy.

are sustainable investments with an environmental objective that **do not take into account the criteria** for environmentally sustainable economic activities under the EU Taxonomy.



What is the minimum share of socially sustainable investments?

The Sub-Fund’s Investment Manager does not commit to a minimum share of socially sustainable investments.



What investments are included under “#2 Other”, what is their purpose and are there any minimum environmental or social safeguards?

Under “#2 Other” investments into cash, Target Funds, or derivatives can be included. Derivatives might be used for efficient portfolio management (including risk hedging) and/or investment purposes, and Target Funds to benefit from a specific strategy. For those investments no environmental or social safeguards are applied.



Is a specific index designated as a reference benchmark to determine whether this financial product is aligned with the environmental and/or social characteristics that it promotes?

Yes, the Sub-Fund has assigned the S&P Europe Large Cap Growth Total Return Net as a benchmark. This benchmark is a market index. The Sub-Fund will promote environmental and social characteristics by outperforming the benchmark's Weighted Average GHG Intensity

Reference benchmarks are indexes to measure whether the financial product attains the environmental or social characteristics that they promote.

- **How is the reference benchmark continuously aligned with each of the environmental or social characteristics promoted by the financial product?**

The benchmark is a market index and does not incorporate environmental or social characteristics for index construction.

- **How is the alignment of the investment strategy with the methodology of the index ensured on a continuous basis?**

The benchmark is not continuously aligned as it does not incorporate environmental or social characteristics for index construction.

- **How does the designated index differ from a relevant broad market index?**

The benchmark is a broad market index.

- **Where can the methodology used for the calculation of the designated index be found?**

Details of the Benchmark's methodology may be found at <https://www.spglobal.com/spdji/en/documents/methodologies/methodology-sp-global-bmi-sp-ifci-indices.pdf> or at www.spglobal.com



Where can I find more product specific information online?

More product-specific information can be found on the website: <https://regulatory.allianzgi.com/SFDR>

Template pre-contractual disclosure for the financial products referred to in Article 8, paragraphs 1, 2 and 2a, of Regulation (EU) 2019/2088 and Article 6, first paragraph, of Regulation (EU) 2020/852

Product name:

Allianz Europe Equity SRI

Legal entity identifier: 529900YVCW4Q1OX95C76

Environmental and/or social characteristics

Sustainable investment means an investment in an economic activity that contributes to an environmental or social objective, provided that the investment does not significantly harm any environmental or social objective and that the investee companies follow good governance practices.

The **EU Taxonomy** is a classification system laid down in Regulation (EU) 2020/852, establishing a list of **environmentally sustainable economic activities**. That Regulation does not include a list of socially sustainable economic activities. Sustainable investments with an environmental objective might be aligned with the Taxonomy or not.

Does this financial product have a sustainable investment objective?	
Yes	No
<input type="checkbox"/> It will make a minimum of sustainable investments with an environmental objective: ___% <ul style="list-style-type: none"> <input type="checkbox"/> in economic activities that qualify as environmentally sustainable under the EU Taxonomy <input type="checkbox"/> in economic activities that do not qualify as environmentally sustainable under the EU Taxonomy 	<input checked="" type="checkbox"/> It promotes Environmental/Social (E/S) characteristics and while it does not have as its objective a sustainable investment, it will have a minimum proportion of 15.00% of sustainable investments <ul style="list-style-type: none"> <input checked="" type="checkbox"/> with an environmental objective in economic activities that qualify as environmentally sustainable under the EU Taxonomy <input checked="" type="checkbox"/> with an environmental objective in economic activities that do not qualify as environmentally sustainable under the EU Taxonomy <input checked="" type="checkbox"/> with a social objective
<input type="checkbox"/> It will make a minimum of sustainable investments with a social objective ___%	<input type="checkbox"/> It promotes E/S characteristics, but will not make any sustainable investments



What environmental and/or social characteristics are promoted by this financial product?

Allianz Europe Equity SRI (the "Sub-Fund") promotes environmental, social, human rights, governance, and business behaviour factors (this domain does not apply for sovereigns issued by a Sovereign Entity) through the integration of a best-in-class approach into the Sub-Fund's investment process. This encompasses the evaluation of corporate or sovereign issuers based on an SRI Rating that it is used to construct the portfolio.

In addition, sustainable minimum exclusion criteria and Sub-Fund specific exclusion criteria apply.

No reference benchmark has been designated for the purpose of attaining the environmental and/or social characteristics promoted by the Sub-Fund.

● What sustainability indicators are used to measure the attainment of each of the environmental or social characteristics promoted by this financial product?

To measure the attainment of the environmental and/or social characteristics the following sustainability indicators are used and reported on, at the fiscal year end:

- The actual percentage of the Sub-Fund's Portfolio (Portfolio in this respect does not comprise non-rated derivatives and instruments that are non-rated by nature (e. g., cash and deposits)) invested in best-in-class issuers (issuers with a minimum SRI Rating of 2 out of a scale from 0-4; 0 being the worst rating and 4 the best rating) is compared to the actual percentage of the benchmarks best-in-class issuers.
- Adherence to a 20% reduction of the investment universe

Sustainability indicators measure how the environmental or social characteristics promoted by the financial product are attained.

- Confirmation that Principal Adverse Impacts (PAIs) of investment decisions on sustainability factors are considered through the application of exclusion criteria.

- **What are the objectives of the sustainable investments that the financial product partially intends to make and how does the sustainable investment contribute to such objectives?**

Sustainable investments contribute to environmental and/or social objectives, for which the Investment Manager uses as reference frameworks, among others, the UN Sustainable Development Goals (SDGs), as well as the objectives of the EU Taxonomy:

1. Climate Change Mitigation
2. Climate Change Adaptation
3. Sustainable Use and Protection of Water and Marine Resources
4. Transition to a Circular Economy
5. Pollution Prevention and Control
6. Protection and Restoration of Biodiversity and Ecosystems

The assessment of the positive contribution to the environmental or social objectives is based on a proprietary framework which combines quantitative elements with qualitative inputs from internal research. The methodology applies first a quantitative breakdown of a securities issuer into its business activities. The qualitative element of the framework is an assessment if business activities contribute positively to an environmental or a social objective.

To calculate the positive contribution on the Sub-Fund level the revenue share of each issuer attributable to business activities contributing to environmental and/or social objectives is considered provided the issuer is satisfying the Do No Significant Harm (“DNSH”) and Good Governance principles, and an asset-weighted aggregation is performed as a second step. Moreover, for certain types of securities, which finance specific projects contributing to environmental or social objectives the overall investment is considered to contribute to environmental and/or social objectives, but also for these a DNSH as well as a Good Governance check for issuers is performed.

- **How do the sustainable investments that the financial product partially intends to make, not cause significant harm to any environmental or social sustainable investment objective?**

In order to ensure that Sustainable Investments do not significantly harm any other environmental and/or social objective, the Investment Manager is leveraging the PAI indicators, whereby significance thresholds have been defined to identify significantly harmful issuers. Issuers not meeting the significance threshold can be engaged for a limited time period to remediate the adverse impact. Otherwise, if the issuer does not meet the defined significance thresholds twice subsequently or in case of a failed engagement, it does not pass the DNSH assessment. Investments in securities of issuers which do not pass the DNSH assessment are not counted as sustainable investments.

- *How have the indicators for adverse impacts on sustainability factors been taken into account?*

All mandatory PAI indicators are considered either as part of the application of the exclusion criteria or through thresholds on a sectorial or absolute basis. Significance thresholds have been defined and they refer to qualitative or quantitative criteria.

Recognizing the lack of data coverage for some of the PAI indicators equivalent data points are used to assess PAI indicators when applying the DNSH assessment, when relevant, for the following indicators for corporates: share of non-renewable energy consumption and production, activities negatively affecting biodiversity-sensitive areas, emissions to water, lack of processes and compliance mechanisms to monitor compliance with UNGC principles and OECD Guidelines for Multinational Enterprises; for sovereigns: GHG Intensity and investee countries subject to social violations. In case of securities which finance specific projects contributing to environmental or social objectives equivalent data at project level might be used to ensure that Sustainable Investments do not significantly harm any other environmental and/or social objective. The Investment Manager will strive to increase data coverage for PAI indicators with low data coverage by engaging with issuers and data providers. The Investment Manager will regularly evaluate whether the availability of data has increased sufficiently to potentially include assessment of such data in the investment process.

Principal adverse impacts are the most significant negative impacts of investment decisions on sustainability factors relating to environmental, social and employee matters, respect for human rights, anti-corruption and anti-bribery matters.

● *How are the sustainable investments aligned with the OECD Guidelines for Multinational Enterprises and the UN Guiding Principles on Business and Human Rights? Details:*

The Investment Manager's sustainable minimum exclusion list screens out companies based on their involvement in controversial practices against international norms. The core normative framework consists of the Principles of the UN Global Compact, the OECD Guidelines for Multinational Enterprises and the UN Guiding Principles for Business and Human Rights. Securities issued by companies having a severe violation of these frameworks will be restricted from the investment universe.

The EU Taxonomy sets out a "do not significant harm" principle by which Taxonomy-aligned investments should not significantly harm EU Taxonomy objectives and is accompanied by specific EU criteria.

The "do not significant harm" principle applies only to those investments underlying the financial product that take into account the EU criteria for environmentally sustainable economic activities. The investments underlying the remaining portion of this financial product do not take into account the EU criteria for environmentally sustainable economic activities.

Any other sustainable investments must also not significantly harm any environmental or social objectives.



Does this financial product consider principal adverse impacts on sustainability factors?

Yes

No

The Management Company has joined the Net Zero Asset Manager Initiative and considers PAI indicators through stewardship including engagement, both are relevant to mitigate potential adverse impact as a company.

Due to the commitment to the Net Zero Asset Manager Initiative, the Management Company aims to reduce greenhouse gas emissions in partnership with asset owner clients on decarbonisation goals, consistent with an ambition to reach net zero emission by 2050 or sooner across all assets under management. As part of this objective the Management Company will set an interim target for the proportion of assets to be managed in line with the attainment of net zero emissions by 2050 or sooner.

The Sub-Fund's Investment Manager considers PAI indicators regarding greenhouse gas emission, biodiversity, water, waste as well as social and employee matters for corporate issuers, and, where relevant, the freedom house index is applied to investments in sovereigns. PAI indicators are considered within the Investment Manager's investment process through the means of exclusions as described in the "binding elements" section of the Sub-Fund.

The data coverage for the data required for the PAI indicators is heterogenous. The data coverage related to biodiversity, water and waste is low and the related PAI indicators are considered through exclusion of securities issued by companies having a severe violation / breach of principles and guidelines such as the Principles of the United Nations Global Compact, the OECD Guidelines for Multinational Enterprises, and the United Nations Guiding Principles for Business and Human Rights on the grounds of problematic practices around human rights, labour rights, environment, and corruption issues. Therefore, the Investment Manager will strive to increase data coverage for PAI indicators with low data coverage. The Investment Manager will regularly evaluate whether the availability of data has increased sufficiently to potentially include assessment of such data in the investment process.

Additionally, PAI indicators are, among other sustainability factors, applied to derive the SRI Rating. The SRI Rating is used for the portfolio construction.

The following PAI indicators are considered:

Applicable to corporate issuers

- GHG Emissions
- Carbon footprint
- GHG Intensity of investee companies
- Exposure to companies active in the fossil fuel sector
- Activities negatively affecting biodiversity-sensitive areas
- Emissions to water
- Hazardous waste ratio

- Violation of UN Global compact principles
- Lack of processes and compliance mechanisms to monitor compliance with UN Global Compact principles
- Board gender diversity
- Exposure to controversial weapons

Applicable to sovereign and supranational issuers

- Investee countries subject to social violations

The information on the PAI indicators will be available in the end-year report of the Sub-Fund.



The investment strategy guides investment decisions based on factors such as investment objectives and risk tolerance.

What investment strategy does this financial product follow?

Allianz Europe Equity SRI's investment objective is to invest in European Equity Markets in accordance with the Sustainable and Responsible Investment Strategy (SRI Strategy Type A).

As part of the SRI best-in-class approach, the Sub-Fund takes environmental, social, human rights, governance, and business behaviour factors into account as follows:

- The aforesaid sustainability factors are analysed through SRI Research by the Investment Manager in order to assess how sustainable development and long-term issues are taken into account in the strategy of an issuer. SRI Research means the overall process of identifying potential risks as well as potential opportunities of an investment in securities of an issuer related to the analysis of sustainability factors. SRI Research data combines external research data (which might have some limitations) with internal analyses.
- Based on a combination of the results of the external and/or internal analyses of the sustainability factors, an internal rating is derived monthly (SRI Rating) and is afterwards assigned to a corporate or sovereign issuer.

This internal SRI Rating is used to rank and select or weight securities for the portfolio construction.

The Sub-Fund's general investment approach (Sub-Fund's applicable General Asset Class Principles in combination with its individual investment restrictions) is described in the prospectus.

● What are the binding elements of the investment strategy used to select the investments to attain each of the environmental or social characteristics promoted by this financial product?

The binding elements are:

- Minimum rating coverage: At least 90% of Sub-Fund's portfolio are required to have an SRI Rating (Portfolio in this respect does not comprise non-rated derivatives and instruments that are non-rated by nature (e.g., cash and deposits)). While most holdings of Sub-Funds will have a corresponding SRI Rating some investments cannot be rated according to the SRI Research methodology. Examples of instruments not attaining to the SRI Rating include, but are not limited to cash, deposits, Target Funds and non-rated investments.
- The rated instruments are adhering to the minimum rating threshold of 2 (out of a rating scale from 0 – 4; 0 being the worst rating and 4 the best rating).
- Reduction of investment universe by excluding at least 20% of issuers.
- Application of the below sustainable minimum exclusion criteria and Sub-Fund specific exclusion criteria according to the SRI Strategy Type A for direct investments.

The following sustainable minimum exclusion criteria for direct investments apply:

- securities issued by companies having a severe violation / breach of principles and guidelines such as the Principles of the United Nations Global Compact, the OECD Guidelines for Multinational Enterprises, and the United Nations Guiding Principles for Business and Human Rights on the grounds of problematic practices around human rights, labour rights, environment, and corruption issues,
- securities issued by companies involved in controversial weapons (anti-personnel mines, cluster munitions, chemical weapons, biological weapons, depleted uranium, white phosphorus, and nuclear weapons),
- securities issued by companies that derive more than 10% of their revenues from weapons, military equipment, and services,

- securities issued by companies that derive more than 10% of their revenue from thermal coal extraction,
- securities issued by utility companies that generate more than 20% of their revenues from coal,
- securities issued by companies involved in the production of tobacco, and securities issued by companies involved in the distribution of tobacco with more than 5% of their revenues.

The following Sub-Fund specific exclusion criteria according to the SRI Strategy Type A (towards Sustainability-Compliant) for direct investments apply:

- securities issued by companies involved in the production of tobacco, and securities issued by companies which derive more than 5% of their revenues from the distribution of tobacco,
- securities issued by companies involved in controversial weapons (anti-personnel mines, cluster munitions, chemical weapons, biological weapons, depleted uranium weapons, white phosphorus weapons, and nuclear weapons), and securities issued by companies that derive more than 5% of their revenues from the involvement in weapons, military equipment, and services,
- securities issued by companies that generate more than 5% of their revenue from thermal coal or conventional oil and gas or non-conventional oil and gas-related activities such as exploration, mining, extraction, distribution, or refinement, or providing dedicated equipment or services. This includes, but is not limited to, the extraction of tar/oil sands, shale oil, shale gas and arctic drilling. The aforesaid exclusion criteria is not applicable for those issuers which have a Science Based Targets initiative (SBTi) target set at well-below 2°C' or 1.5°C', or have a SBTi 'Business Ambition for 1.5°C' commitment,
- securities issued by companies that derive more than 5% of their revenues from coal-based energy generation. The aforesaid exclusion criterium is not applicable for those issuers which have a Science Based Targets initiative (SBTi) target set at well below 2°C' or 1.5°C', or have a SBTi 'Business Ambition for 1.5°C' commitment, or
- securities issued by companies which are involved in nuclear-, gas- or coal-based energy generation related products or services unless they derive more than 50% of their revenues from contributing activities (economic activities included in the EU taxonomy). The aforesaid exclusion criterium is not applicable for those issuers which have a Science Based Targets initiative (SBTi) target set at well-below 2°C' or 1.5°C' or have a SBTi 'Business Ambition for 1.5°C' commitment.

Direct investments in sovereign issuers with an insufficient freedom house index score are excluded.

The sustainable minimum exclusion criteria, as well as the Sub-Fund specific exclusion criteria according to the SRI Strategy Type A, are based on information from an external data provider and coded in pre- and post-trade compliance. The review is performed at least half yearly.

● **What is the committed minimum rate to reduce the scope of the investments considered prior to the application of that investment strategy?**

The Sub-Fund commits to reduce the investment universe by at least 20%.

● **What is the policy to assess good governance practices of the investee companies?**

Good governance principles are considered by screening out companies based on their involvement in controversies around international norms corresponding to the four good governance practices: sound management structures, employee relations, remuneration of staff and tax compliance. Companies having a severe violation in either of those areas will not be investible. For certain cases, flagged issuers shall be on a watch list. These companies will appear on this watch list when the Investment Manager believes that engagement may lead to improvements or when the company is assessed to take remedial actions. Companies on the watch list remain investible unless the Investment Manager believes that the engagement or the remedial actions of the company does not lead to the desired remedy of the severe controversy.

In addition, the Sub-Fund's Investment Manager is committed to actively encourage open dialogues with investee companies on corporate governance, proxy voting and broader sustainability issues in advance of shareholder meetings (regularly for direct investments in shares). The Sub-Fund's Investment Manager's approach to proxy voting and company engagement is set out in the Management Company's Stewardship Statement.

Good governance practices include sound management structures, employee relations, remuneration of staff and tax compliance.



What is the asset allocation planned for this financial product?

Asset allocation describes the share of investments in specific assets.

Min. 90% of the Sub-Funds' assets (excluding cash and non-rated derivatives) are used to meet the environmental or social characteristics promoted by this Sub-Fund. A low portion of the Sub-Fund might contain assets which do not promote environmental or social characteristics. Examples of such instruments are derivatives, cash and deposits, some Target Funds and investment with temporarily divergent or absent environmental, social, or good governance qualifications. Min. 15% of the Sub-Funds' assets will be invested in Sustainable Investments. The minimum percentage of investments that are aligned with the EU Taxonomy is 0.01%. The Sub-Fund's Investment Manager does not commit to a minimum share of environmentally Sustainable Investments that are not aligned with the EU Taxonomy. The Sub-Fund's Investment Manager does not commit to a minimum share of socially sustainable investments. While the Sub-Fund cannot commit to a minimum share of environmentally or socially sustainable investments, such investments may be freely allocated to within the Sub-Fund aggregated sustainable investment commitment disclosed (min. 15%).

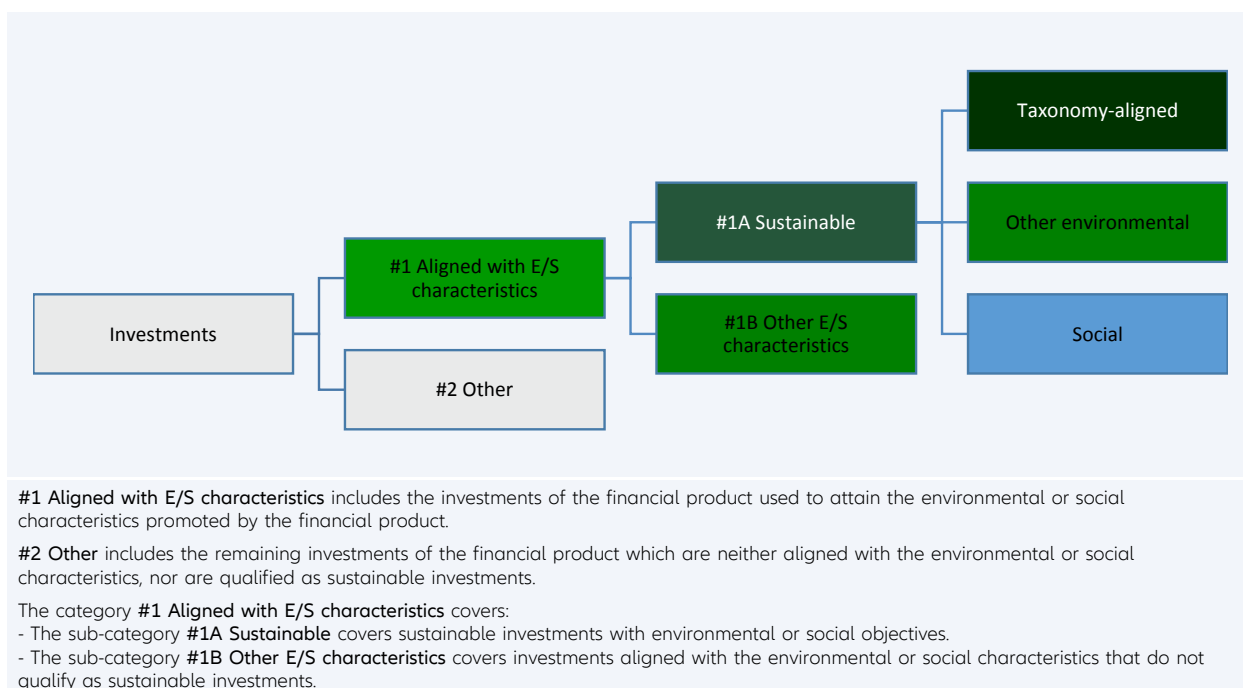

- **How does the use of derivatives attain the environmental or social characteristics promoted by the financial product?**

Not applicable



To what minimum extent are sustainable investments with an environmental objective aligned with the EU Taxonomy?

The Taxonomy-aligned investments include debt and/or equity in environmentally sustainable economic activities aligned with the EU-Taxonomy. The minimum percentage of investments that are aligned with the EU Taxonomy is 0.01%. Taxonomy-aligned data is provided by an external data provider. The Investment Manager has assessed the quality of such data. The data will not be subject to an assurance provided by auditors or a review by third parties. The data will not reflect any data in government bonds. As of today, there is no recognized methodology available to determine the proportion of Taxonomy-aligned activities when investing in government bonds.

Taxonomy-aligned activities in this disclosure are based on share of turnover. Pre-contractual figures use turnover as its financial metric as a default in line with the regulatory requirements and based on the fact that complete, verifiable or up-to date data for CAPEX and/or OPEX as financial metric is even less available.

Taxonomy-aligned data is only in rare cases data reported by companies in accordance with the EU Taxonomy. The data provider has derived Taxonomy-aligned data from other available equivalent public data.

● **Does the financial product invest in fossil gas and/or nuclear energy related activities that comply with the EU Taxonomy ¹?**

Yes:

In fossil gas In nuclear energy

No

The Sub-Fund does not pursue any investments in fossil gas and/or nuclear energy related activities that comply with the EU Taxonomy. Nevertheless, as result of this investment strategy, investments may occur in corporates which are also active in these activities. Further information will be provided as part of the annual reporting, if relevant.

The two graphs below show in green the minimum percentage of investments that are aligned with the EU Taxonomy. As there is no appropriate methodology to determine the Taxonomy-alignment of sovereign bonds, the first graph shows the Taxonomy-alignment in relation to all the investments of the financial product including sovereign bonds, while the second graph shows the Taxonomy-alignment only in relation to the investments of the financial product other than sovereign bonds.*

1. Taxonomy-alignment of investments including sovereign bonds*

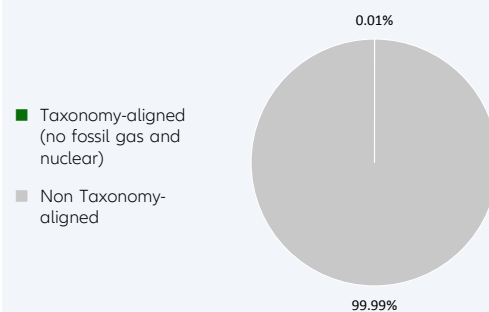

2. Taxonomy-alignment of investments excluding sovereign bonds*

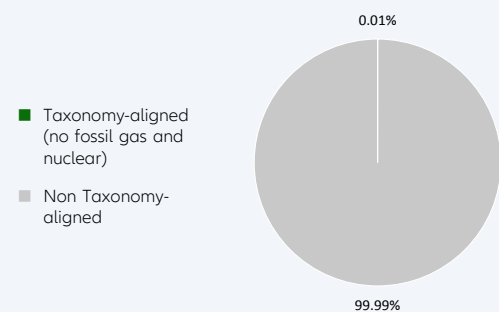

This graph represents X% of the total investments.

It is noted that this Sub-Fund does not provide for a binding minimum quota for investments in sovereign bonds. Therefore, this Sub-Fund may have (but must not have) an exposure to sovereign bonds. In the absence of a binding minimum quota for investments in sovereign bonds, this graph does not generate any additional added value compared to the left-hand graph.

* For the purpose of these graphs, 'sovereign bonds' consist of all sovereign exposures

● **What is the minimum share of investments in transitional and enabling activities?**

The Sub-Fund's Investment Manager does not commit to a split of minimum taxonomy alignment into transitional, enabling activities and own performance.

Taxonomy-aligned activities are expressed as a share of:

- **turnover** reflecting the share of revenue from green activities of investee companies
- **capital expenditure** (CapEx) showing the green investments made by investee companies, e.g. for a transition to a green economy.
- **operational expenditure** (OpEx) reflecting green operational activities of investee companies.

Enabling activities directly enable other activities to make a substantial contribution to an environmental objective.

Transitional activities are activities for which low-carbon alternatives are not yet available and among others have greenhouse gas emission levels corresponding to the best performance.

¹ Fossil gas and/or nuclear related activities will only comply with the EU Taxonomy where they contribute to limiting climate change ("climate change mitigation") and do not significantly harm any EU Taxonomy objective - see explanatory note in the left hand margin. The full criteria for fossil gas and nuclear energy economic activities that comply with the EU Taxonomy are laid down in Commission Delegated Regulation (EU) 2022/1214.



What is the minimum share of sustainable investments with an environmental objective that are not aligned with the EU Taxonomy?

Taxonomy-aligned investments are considered a sub-category of Sustainable Investments. If an investment is not Taxonomy-aligned since the activity is not yet covered under the EU Taxonomy or the positive contribution is not substantial enough to comply with the Taxonomy technical screening criteria, the investment can still be considered an environmentally Sustainable Investment provided it complies with all criteria. The Investment Manager does not commit to a minimum share of environmentally Sustainable Investments that are not aligned with the EU Taxonomy. The overall sustainable investment share may also include investments with an environmental objective in economic activities that do not qualify as environmentally sustainable under the EU Taxonomy, and while the Sub-Fund cannot commit to a minimum share of environmentally or socially sustainable investments, such investments may be freely allocated to within the Sub-Fund aggregated sustainable investment commitment disclosed (min. 15%).



What is the minimum share of socially sustainable investments?

The Investment Manager defines Sustainable Investments based on internal research, which uses, among others, the UN Sustainable Development Goals (SDGs), as well as the objectives of the EU Taxonomy as reference frameworks. The Investment Manager does not commit to a minimum share of socially Sustainable Investments, as the SDGs contain environmental as well as social objectives. The overall sustainable investment share may also include investments with a social objective, and while the Sub-Fund cannot commit to a minimum share of environmentally or socially sustainable investments, such investments may be freely allocated to within the Sub-Fund aggregated sustainable investment commitment disclosed (min. 15%).



What investments are included under “#2 Other”, what is their purpose and are there any minimum environmental or social safeguards?

Under “#2 Other” investments into cash, Target Funds, or derivatives can be included. Derivatives might be used for efficient portfolio management (including risk hedging) and/or investment purposes, and Target Funds to benefit from a specific strategy. For those investments no environmental or social safeguards are applied.



Is a specific index designated as a reference benchmark to determine whether this financial product is aligned with the environmental and/or social characteristics that it promotes?

No reference benchmark has been designated for the purpose of attaining the environmental and/or social characteristics promoted by the Sub-Fund.

- How is the reference benchmark continuously aligned with each of the environmental or social characteristics promoted by the financial product?

Not applicable

- How is the alignment of the investment strategy with the methodology of the index ensured on a continuous basis?

Not applicable

- How does the designated index differ from a relevant broad market index?

Not applicable

- Where can the methodology used for the calculation of the designated index be found?

Not applicable



are sustainable investments with an environmental objective that **do not take into account the criteria** for environmentally sustainable economic activities under the EU Taxonomy.

Reference benchmarks are indexes to measure whether the financial product attains the environmental or social characteristics that they promote.



Where can I find more product specific information online?

More product-specific information can be found on the website: <https://regulatory.allianzgi.com/SFDR>

Template pre-contractual disclosure for the financial products referred to in Article 8, paragraphs 1, 2 and 2a, of Regulation (EU) 2019/2088 and Article 6, first paragraph, of Regulation (EU) 2020/852

Product name:

Allianz Europe Equity Value

Legal entity identifier: 222100SUFLTZGSP5T321

Environmental and/or social characteristics

Sustainable investment means an investment in an economic activity that contributes to an environmental or social objective, provided that the investment does not significantly harm any environmental or social objective and that the investee companies follow good governance practices.

The **EU Taxonomy** is a classification system laid down in Regulation (EU) 2020/852, establishing a list of **environmentally sustainable economic activities**. That Regulation does not include a list of socially sustainable economic activities. Sustainable investments with an environmental objective might be aligned with the Taxonomy or not.

Does this financial product have a sustainable investment objective?	
Yes	No
<input type="checkbox"/> It will make a minimum of sustainable investments with an environmental objective: ___% <ul style="list-style-type: none"> <input type="checkbox"/> in economic activities that qualify as environmentally sustainable under the EU Taxonomy <input type="checkbox"/> in economic activities that do not qualify as environmentally sustainable under the EU Taxonomy 	<input checked="" type="checkbox"/> It promotes Environmental/Social (E/S) characteristics and while it does not have as its objective a sustainable investment, it will have a minimum proportion of 10.00% of sustainable investments <ul style="list-style-type: none"> <input checked="" type="checkbox"/> with an environmental objective in economic activities that qualify as environmentally sustainable under the EU Taxonomy <input checked="" type="checkbox"/> with an environmental objective in economic activities that do not qualify as environmentally sustainable under the EU Taxonomy <input checked="" type="checkbox"/> with a social objective
<input type="checkbox"/> It will make a minimum of sustainable investments with a social objective ___%	<input type="checkbox"/> It promotes E/S characteristics, but will not make any sustainable investments



What environmental and/or social characteristics are promoted by this financial product?

Allianz Europe Equity Value (the "Sub-Fund") is managed according to the Sustainability Key Performance Indicator Strategy (Relative) ("KPI Strategy (Relative)") which addresses greenhouse gas (GHG) Intensity. The "Sustainability KPI" measures the GHG Intensity defined by the weighted average intensity of greenhouse gas emissions based on company's annual sales ("GHG Intensity").

GHG Intensity will be addressed by outperforming the Weighted Average GHG Intensity against its benchmark.

In addition, sustainable minimum exclusion criteria apply.

A reference benchmark has been designated for the purpose of attaining the environmental and/or social characteristics promoted by the Sub-Fund.

● What sustainability indicators are used to measure the attainment of each of the environmental or social characteristics promoted by this financial product?

To measure the attainment of the environmental and/or social characteristics the following sustainability indicators are used and reported on, at the fiscal year end:

- The actual percentage of KPI coverage of the Sub-Fund's Portfolio (Portfolio in this respect does not comprise derivatives and instruments that are non-evaluated by nature (e. g., cash and deposits)).
- The actual weighted average GHG Intensity portfolio vs weighted average GHG Intensity of the benchmark.

Sustainability indicators measure how the environmental or social characteristics promoted by the financial product are attained.

- Confirmation that Principal adverse impacts (PAIs) of investment decisions on sustainability factors are considered through the application of exclusion criteria.
- **What are the objectives of the sustainable investments that the financial product partially intends to make and how does the sustainable investment contribute to such objectives?**

Sustainable investments contribute to environmental and/or social objectives, for which the Investment Manager uses as reference frameworks, among others, the UN Sustainable Development Goals (SDGs), as well as the objectives of the EU Taxonomy:

1. Climate Change Mitigation
2. Climate Change Adaptation
3. Sustainable Use and Protection of Water and Marine Resources
4. Transition to a Circular Economy
5. Pollution Prevention and Control
6. Protection and Restoration of Biodiversity and Ecosystems

The assessment of the positive contribution to the environmental or social objectives is based on a proprietary framework which combines quantitative elements with qualitative inputs from internal research. The methodology applies first a quantitative breakdown of a securities issuer into its business activities. The qualitative element of the framework is an assessment if business activities contribute positively to an environmental or a social objective.

To calculate the positive contribution on the Sub-Fund level the revenue share of each issuer attributable to business activities contributing to environmental and/or social objectives is considered provided the issuer is satisfying the Do No Significant Harm (“DNSH”) and Good Governance principles, and an asset-weighted aggregation is performed as a second step. Moreover, for certain types of securities, which finance specific projects contributing to environmental or social objectives the overall investment is considered to contribute to environmental and/or social objectives, but also for these a DNSH as well as a Good Governance check for issuers is performed.

- **How do the sustainable investments that the financial product partially intends to make, not cause significant harm to any environmental or social sustainable investment objective?**

In order to ensure that Sustainable Investments do not significantly harm any other environmental and/or social objective, the Investment Manager is leveraging the PAI indicators, whereby significance thresholds have been defined to identify significantly harmful issuers. Issuers not meeting the significance threshold can be engaged for a limited time period to remediate the adverse impact. Otherwise, if the issuer does not meet the defined significance thresholds twice subsequently or in case of a failed engagement, it does not pass the DNSH assessment. Investments in securities of issuers which do not pass the DNSH assessment are not counted as sustainable investments.

- *How have the indicators for adverse impacts on sustainability factors been taken into account?*

All mandatory PAI indicators are considered either as part of the application of the exclusion criteria or through thresholds on a sectorial or absolute basis. Significance thresholds have been defined and they refer to qualitative or quantitative criteria.

Recognizing the lack of data coverage for some of the PAI indicators equivalent data points are used to assess PAI indicators when applying the DNSH assessment, when relevant, for the following indicators for corporates: share of non-renewable energy consumption and production, activities negatively affecting biodiversity-sensitive areas, emissions to water, lack of processes and compliance mechanisms to monitor compliance with UNGC principles and OECD Guidelines for Multinational Enterprises; for sovereigns: GHG Intensity and investee countries subject to social violations. In case of securities which finance specific projects contributing to environmental or social objectives equivalent data at project level might be used to ensure that Sustainable Investments do not significantly harm any other environmental and/or social objective. The Investment Manager will strive to increase data coverage for PAI indicators with low data coverage by engaging with issuers and data providers. The Investment Manager will regularly evaluate whether the availability of data has increased sufficiently to potentially include assessment of such data in the investment process.

Principal adverse impacts are the most significant negative impacts of investment decisions on sustainability factors relating to environmental, social and employee matters, respect for human rights, anti-corruption and anti-bribery matters.

- *How are the sustainable investments aligned with the OECD Guidelines for Multinational Enterprises and the UN Guiding Principles on Business and Human Rights? Details:*

The Investment Manager's sustainable minimum exclusion list screens out companies based on their involvement in controversial practices against international norms. The core normative framework consists of the Principles of the UN Global Compact, the OECD Guidelines for Multinational Enterprises and the UN Guiding Principles for Business and Human Rights. Securities issued by companies having a severe violation of these frameworks will be restricted from the investment universe.

The EU Taxonomy sets out a "do not significant harm" principle by which Taxonomy-aligned investments should not significantly harm EU Taxonomy objectives and is accompanied by specific EU criteria.

The "do not significant harm" principle applies only to those investments underlying the financial product that take into account the EU criteria for environmentally sustainable economic activities. The investments underlying the remaining portion of this financial product do not take into account the EU criteria for environmentally sustainable economic activities.

Any other sustainable investments must also not significantly harm any environmental or social objectives.



Does this financial product consider principal adverse impacts on sustainability factors?

Yes

No

The Management Company has joined the Net Zero Asset Manager Initiative and considers PAI indicators through stewardship including engagement, both are relevant to mitigate potential adverse impact as a company.

Due to the commitment to the Net Zero Asset Manager Initiative, the Management Company aims to reduce greenhouse gas emissions in partnership with asset owner clients on decarbonisation goals, consistent with an ambition to reach net zero emission by 2050 or sooner across all assets under management. As part of this objective the Management Company will set an interim target for the proportion of assets to be managed in line with the attainment of net zero emissions by 2050 or sooner.

The Sub-Fund's Investment Manager addresses PAI indicators regarding greenhouse gas emission, biodiversity, water, waste as well as social and employee matters for corporate issuers, and, where relevant, the freedom house index is applied to investments in sovereigns. PAI indicators are considered within the Investment Manager's investment process through the means of exclusions as described in the "binding elements" section of the Sub-Fund.

The data coverage for the data required for the PAI indicators is heterogenous. The data coverage related to biodiversity, water and waste is low and the related PAI indicators are considered through exclusion of securities issued by companies having a severe violation / breach of principles and guidelines such as the Principles of the United Nations Global Compact, the OECD Guidelines for Multinational Enterprises, and the United Nations Guiding Principles for Business and Human Rights on the grounds of problematic practices around human rights, labour rights, environment, and corruption issues. Therefore, the Investment Manager will strive to increase data coverage for PAI indicators with low data coverage. The Investment Manager will regularly evaluate whether the availability of data has increased sufficiently to potentially include assessment of such data in the investment process.

Additionally, the Investment manager considers GHG related PAI indicators by outperforming the Weighted Average GHG Intensity against its benchmark.

The following PAI indicators are considered:

Applicable to corporate issuers

- GHG Emissions
- Carbon footprint
- GHG Intensity of investee companies
- Exposure to companies active in the fossil fuel sector
- Activities negatively affecting biodiversity-sensitive areas
- Emissions to water
- Hazardous waste ratio

- Violation of UN Global compact principles
- Lack of processes and compliance mechanisms to monitor compliance with UN Global Compact principles
- Board gender diversity
- Exposure to controversial weapons

Applicable to sovereign and supranational issuers

- Investee countries subject to social violations

The information on the PAI indicators will be available in the end-year report of the Sub-Fund.



The investment strategy guides investment decisions based on factors such as investment objectives and risk tolerance.

What investment strategy does this financial product follow?

Allianz Europe Equity Value's investment objective is to invest in European Equity Markets with a focus on value stocks in accordance with the Sustainability Key Performance Indicator Strategy (Relative) ("KPI Strategy (Relative)").

The Sub-Fund's strategy is to outperform the Weighted Average GHG Intensity against its benchmark. The outperformance is determined as the excess between the Sub-Fund's weighted average GHG Intensity and the Sub-Fund's benchmark Weighted Average GHG Intensity.

The weighted average GHG Intensity is the weighted average of the Sub-Fund's GHG Intensity (in tCO₂e per Millions of sales). Sales represent company's annual sales. This ratio of GHG normalized by Sales facilitates comparison between companies of different sizes. The ratio is in tCO₂e per Millions of sales. The metric allows comparing weighted average GHG Intensities of different portfolios to identify portfolios comprised of more GHG-efficient issuers in terms of the issuer's sales. The portfolio weights (and benchmark or universe weights) are rebased such that only issuers with GHG emissions data available are considered in the calculation. GHG represents a respective issuer's greenhouse gas emissions. To determine the GHG Intensity of a company issuer, GHG Intensity data from third party data providers will be used. The GHG intensity is analysed by the Investment Manager and is considered within the securities selection process in order to meet the Sub-Fund Investment objective.

The proportion of assets which do not have a GHG intensity assessment is expected to be low. Examples of instruments not having a GHG intensity assessment are cash and deposits, some Target Funds, and investments for which the GHG intensity is deemed to be not appropriate and/or data is not available.

The Sub-Fund's general investment approach (Sub-Fund's applicable General Asset Class Principles in combination with its individual investment restrictions) is described in the prospectus.

● What are the binding elements of the investment strategy used to select the investments to attain each of the environmental or social characteristics promoted by this financial product?

The binding elements are:

- Min. 80% KPI coverage of the Sub-Fund's Portfolio (Portfolio in this respect does not comprise derivatives and instruments that are non-evaluated by nature (e. g., cash and deposits)).
- Min. 20% outperformance of benchmark in terms of Weighted Average GHG Intensity.
- Application of the following sustainable minimum exclusion criteria for direct investments:
 - securities issued by companies having a severe violation / breach of principles and guidelines such as the Principles of the United Nations Global Compact, the OECD Guidelines for Multinational Enterprises, and the United Nations Guiding Principles for Business and Human Rights on the grounds of problematic practices around human rights, labour rights, environment, and corruption issues,
 - securities issued by companies involved in controversial weapons (anti-personnel mines, cluster munitions, chemical weapons, biological weapons, depleted uranium, white phosphorus, and nuclear weapons),
 - securities issued by companies that derive more than 10% of their revenues from weapons, military equipment, and services,
 - securities issued by companies that derive more than 10% of their revenue from thermal coal extraction,
 - securities issued by utility companies that generate more than 20% of their revenues from coal,

- securities issued by companies involved in the production of tobacco, and securities issued by companies involved in the distribution of tobacco with more than 5% of their revenues.

Direct investments in sovereign issuers with an insufficient freedom house index score are excluded.

The sustainable minimum exclusion criteria are based on information from an external data provider and coded in pre- and post-trade compliance. The review is performed at least half yearly.

- **What is the committed minimum rate to reduce the scope of the investments considered prior to the application of that investment strategy?**

The Sub-Fund does not commit to reduce the scope of the investments by a certain minimum rate.

- **What is the policy to assess good governance practices of the investee companies?**

Good governance principles are considered by screening out companies based on their involvement in controversies around international norms corresponding to the four good governance practices: sound management structures, employee relations, remuneration of staff and tax compliance. Companies having a severe violation in either of those areas will not be investible. For certain cases, flagged issuers shall be on a watch list. These companies will appear on this watch list when the Investment Manager believes that engagement may lead to improvements or when the company is assessed to take remedial actions. Companies on the watch list remain investible unless the Investment Manager believes that the engagement or the remedial actions of the company does not lead to the desired remedy of the severe controversy.

In addition, the Sub-Fund's Investment Manager is committed to actively encourage open dialogues with investee companies on corporate governance, proxy voting and broader sustainability issues in advance of shareholder meetings (regularly for direct investments in shares). The Sub-Fund's Investment Manager's approach to proxy voting and company engagement is set out in the Management Company's Stewardship Statement.

Good governance practices include sound management structures, employee relations, remuneration of staff and tax compliance.



What is the asset allocation planned for this financial product?

Asset allocation describes the share of investments in specific assets.

Min. 80% of the Sub-Funds' assets (excluding cash, and derivatives) are used to meet the environmental or social characteristics promoted by this Sub-Fund. A low portion of the Sub-Fund might contain assets which do not promote environmental or social characteristics. Examples of such instruments are derivatives, cash and deposits, some Target Funds and investment with temporarily divergent or absent environmental, social, or good governance qualifications. Min. 10% of the Sub-Funds' assets will be invested in Sustainable Investments. The minimum percentage of investments that are aligned with the EU Taxonomy is 0.01%. The Sub-Fund's Investment Manager does not commit to a minimum share of environmentally Sustainable Investments that are not aligned with the EU Taxonomy. The Sub-Fund's Investment Manager does not commit to a minimum share of socially sustainable investments. While the Sub-Fund cannot commit to a minimum share of environmentally or socially sustainable investments, such investments may be freely allocated to within the Sub-Fund aggregated sustainable investment commitment disclosed (min. 10%).

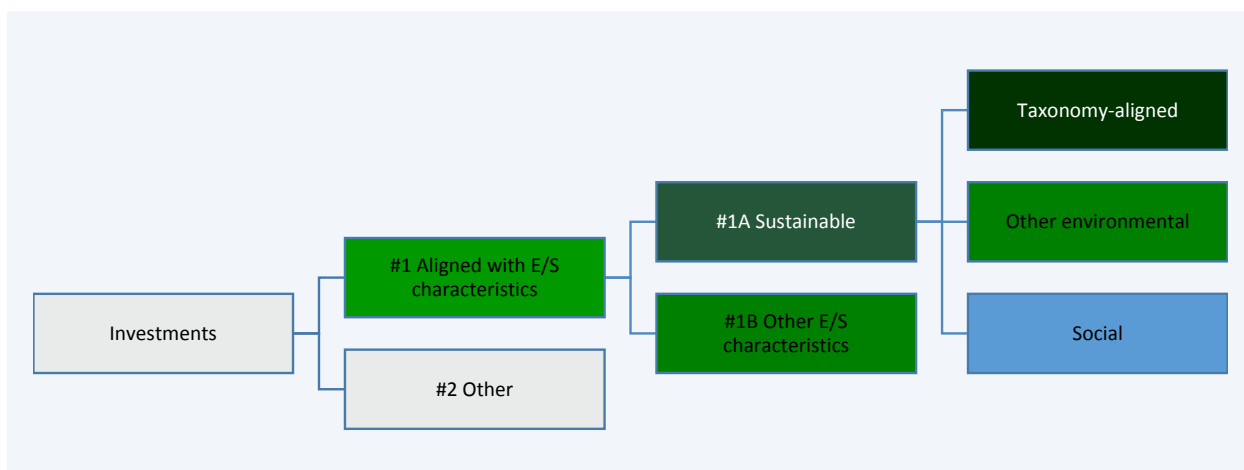

#1 Aligned with E/S characteristics includes the investments of the financial product used to attain the environmental or social characteristics promoted by the financial product.

#2 Other includes the remaining investments of the financial product which are neither aligned with the environmental or social characteristics, nor are qualified as sustainable investments.

The category **#1 Aligned with E/S characteristics** covers:

- The sub-category **#1A Sustainable** covers sustainable investments with environmental or social objectives.
- The sub-category **#1B Other E/S characteristics** covers investments aligned with the environmental or social characteristics that do not qualify as sustainable investments.

- **How does the use of derivatives attain the environmental or social characteristics promoted by the financial product?**

Not applicable



To what minimum extent are sustainable investments with an environmental objective aligned with the EU Taxonomy?

The Taxonomy-aligned investments include debt and/or equity in environmentally sustainable economic activities aligned with the EU-Taxonomy. The minimum percentage of investments that are aligned with the EU Taxonomy is 0.01%. Taxonomy-aligned data is provided by an external data provider. The Investment Manager has assessed the quality of such data. The data will not be subject to an assurance provided by auditors or a review by third parties. The data will not reflect any data in government bonds. As of today, there is no recognized methodology available to determine the proportion of Taxonomy-aligned activities when investing in government bonds.

Taxonomy-aligned activities in this disclosure are based on share of turnover. Pre-contractual figures use turnover as its financial metric as a default in line with the regulatory requirements and based on the fact that complete, verifiable or up-to date data for CAPEX and/or OPEX as financial metric is even less available.

Taxonomy-aligned data is only in rare cases data reported by companies in accordance with the EU Taxonomy. The data provider has derived Taxonomy-aligned data from other available equivalent public data.

- **Does the financial product invest in fossil gas and/or nuclear energy related activities that comply with the EU Taxonomy¹?**

Yes:

In fossil gas In nuclear energy

No

The Sub-Fund does not pursue any investments in fossil gas and/or nuclear energy related activities that comply with the EU Taxonomy. Nevertheless, as result of this investment strategy, investments may occur in corporates which are also active in these activities. Further information will be provided as part of the annual reporting, if relevant.

Taxonomy-aligned activities are expressed as a share of:

- **turnover** reflecting the share of revenue from green activities of investee companies
- **capital expenditure** (CapEx) showing the green investments made by investee companies, e.g. for a transition to a green economy.
- **operational expenditure** (OpEx) reflecting green operational activities of investee companies.

¹ Fossil gas and/or nuclear related activities will only comply with the EU Taxonomy where they contribute to limiting climate change ("climate change mitigation") and do not significantly harm any EU Taxonomy objective - see explanatory note in the left hand margin. The full criteria for fossil gas and nuclear energy economic activities that comply with the EU Taxonomy are laid down in Commission Delegated Regulation (EU) 2022/1214.

The two graphs below show in green the minimum percentage of investments that are aligned with the EU Taxonomy. As there is no appropriate methodology to determine the Taxonomy-alignment of sovereign bonds*, the first graph shows the Taxonomy-alignment in relation to all the investments of the financial product including sovereign bonds, while the second graph shows the Taxonomy-alignment only in relation to the investments of the financial product other than sovereign bonds.

1. Taxonomy-alignment of investments including sovereign bonds*

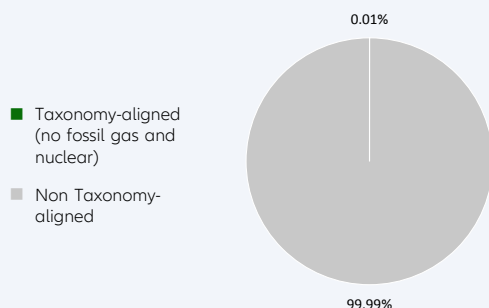

2. Taxonomy-alignment of investments excluding sovereign bonds*

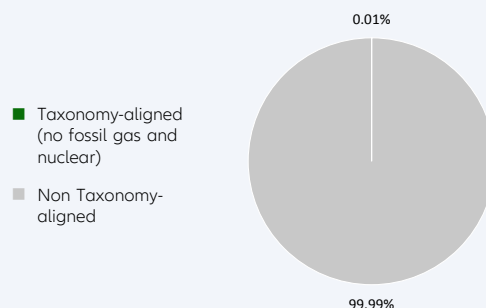

This graph represents X% of the total investments. It is noted that this Sub-Fund does not provide for a binding minimum quota for investments in sovereign bonds. Therefore, this Sub-Fund may have (but must not have) an exposure to sovereign bonds. In the absence of a binding minimum quota for investments in sovereign bonds, this graph does not generate any additional added value compared to the left-hand graph.

* For the purpose of these graphs, 'sovereign bonds' consist of all sovereign exposures

Enabling activities directly enable other activities to make a substantial contribution to an environmental objective.

Transitional activities are activities for which low-carbon alternatives are not yet available and among others have greenhouse gas emission levels corresponding to the best performance.

● **What is the minimum share of investments in transitional and enabling activities?**

The Sub-Fund's Investment Manager does not commit to a split of minimum taxonomy alignment into transitional, enabling activities and own performance.



What is the minimum share of sustainable investments with an environmental objective that are not aligned with the EU Taxonomy?

Taxonomy-aligned investments are considered a sub-category of Sustainable Investments. If an investment is not Taxonomy-aligned since the activity is not yet covered under the EU Taxonomy or the positive contribution is not substantial enough to comply with the Taxonomy technical screening criteria, the investment can still be considered an environmentally Sustainable Investment provided it complies with all criteria. The Investment Manager does not commit to a minimum share of environmentally Sustainable Investments that are not aligned with the EU Taxonomy. The overall sustainable investment share may also include investments with an environmental objective in economic activities that do not qualify as environmentally sustainable under the EU Taxonomy, and while the Sub-Fund cannot commit to a minimum share of environmentally or socially sustainable investments, such investments may be freely allocated to within the Sub-Fund aggregated sustainable investment commitment disclosed (min 10%).



are sustainable investments with an environmental objective that **do not take into account the criteria** for environmentally sustainable economic activities under the EU Taxonomy.



What is the minimum share of socially sustainable investments?

The Investment Manager defines Sustainable Investments based on internal research, which uses, among others, the UN Sustainable Development Goals (SDGs), as well as the objectives of the EU Taxonomy as reference frameworks. The Investment Manager does not commit to a minimum share of socially Sustainable Investments, as the SDGs contain environmental as well as social objectives. The overall sustainable investment share may also include investments with a social objective, and while the Sub-Fund cannot commit to a minimum share of environmentally or socially sustainable investments, such investments may be freely allocated to within the Sub-Fund aggregated sustainable investment commitment disclosed (min 10%).



What investments are included under “#2 Other”, what is their purpose and are there any minimum environmental or social safeguards?

Under “#2 Other” investments into cash, Target Funds, or derivatives can be included. Derivatives might be used for efficient portfolio management (including risk hedging) and/or investment purposes, and Target Funds to benefit from a specific strategy. For those investments no environmental or social safeguards are applied.



Is a specific index designated as a reference benchmark to determine whether this financial product is aligned with the environmental and/or social characteristics that it promotes?

Yes, the Sub-Fund has assigned the S&P Europe Large Mid Cap Value Total Return as a benchmark. This benchmark is a market index. The Sub-Fund will promote environmental and social characteristics by outperforming the benchmark's Weighted Average GHG Intensity

Reference benchmarks are indexes to measure whether the financial product attains the environmental or social characteristics that they promote.

- **How is the reference benchmark continuously aligned with each of the environmental or social characteristics promoted by the financial product?**

The benchmark is a market index and does not incorporate environmental or social characteristics for index construction.

- **How is the alignment of the investment strategy with the methodology of the index ensured on a continuous basis?**

The benchmark is not continuously aligned as it does not incorporate environmental or social characteristics for index construction.

- **How does the designated index differ from a relevant broad market index?**

The benchmark is a broad market index.

- **Where can the methodology used for the calculation of the designated index be found?**

Details of the Benchmark's methodology may be found at <https://www.spglobal.com/spdji/en/indices/strategy/sp-enhanced-value-europe-largemidcap-index/#overview> or at www.spglobal.com



Where can I find more product specific information online?

More product-specific information can be found on the website: <https://regulatory.allianzgi.com/SFDR>

Template pre-contractual disclosure for the financial products referred to in Article 8, paragraphs 1, 2 and 2a, of Regulation (EU) 2019/2088 and Article 6, first paragraph, of Regulation (EU) 2020/852

Product name:

Allianz Europe Mid Cap Equity

Legal entity identifier: 5493003SBYUCYZ0WXS18

Environmental and/or social characteristics

Sustainable investment means an investment in an economic activity that contributes to an environmental or social objective, provided that the investment does not significantly harm any environmental or social objective and that the investee companies follow good governance practices.

The EU Taxonomy is a classification system laid down in Regulation (EU) 2020/852, establishing a list of environmentally sustainable economic activities. That Regulation does not include a list of socially sustainable economic activities. Sustainable investments with an environmental objective might be aligned with the Taxonomy or not.

Does this financial product have a sustainable investment objective?	
Yes	No
<input type="checkbox"/> It will make a minimum of sustainable investments with an environmental objective: ___% <input type="checkbox"/> in economic activities that qualify as environmentally sustainable under the EU Taxonomy <input type="checkbox"/> in economic activities that do not qualify as environmentally sustainable under the EU Taxonomy	<input checked="" type="checkbox"/> It promotes Environmental/Social (E/S) characteristics and while it does not have as its objective a sustainable investment, it will have a minimum proportion of 30.00% of sustainable investments <input checked="" type="checkbox"/> with an environmental objective in economic activities that qualify as environmentally sustainable under the EU Taxonomy <input checked="" type="checkbox"/> with an environmental objective in economic activities that do not qualify as environmentally sustainable under the EU Taxonomy <input checked="" type="checkbox"/> with a social objective
<input type="checkbox"/> It will make a minimum of sustainable investments with a social objective ___%	<input type="checkbox"/> It promotes E/S characteristics, but will not make any sustainable investments



What environmental and/or social characteristics are promoted by this financial product?

Allianz Europe Mid Cap Equity (the "Sub-Fund") is managed according to the Sustainability Key Performance Indicator Strategy (Absolute Threshold) ("KPI Strategy (Absolute Threshold)") which targets a specific minimum allocation into Sustainable Investments. Sustainable investments are investments in economic activities which contribute to environmental and/or social objectives, for which the Investment Managers uses as reference frameworks the UN Sustainable Development Goals (SDGs), as well as the objectives of the EU Taxonomy.

Furthermore, the Sub-Fund will limit its allocation into issuers which significantly harm environmental and/or social objectives.

In addition, sustainable minimum exclusion criteria apply.

No reference benchmark has been designated for the purpose of attaining the environmental and/or social characteristics promoted by the Sub-Fund.

● What sustainability indicators are used to measure the attainment of each of the environmental or social characteristics promoted by this financial product?

To measure the attainment of the environmental and/or social characteristics the following sustainability indicators are used and reported on, at the fiscal year end:

- The actual percentage of KPI coverage of the Sub-Fund's Portfolio (Portfolio in this respect does not comprise derivatives and instruments that are non-evaluated by nature (e. g., cash and deposits)).
- The actual weighted average sustainable investment share of Sub-Fund Assets.

Sustainability indicators measure how the environmental or social characteristics promoted by the financial product are attained.

- The actual share of investments not satisfying the Do No Significant Harm (“DNSH”) assessment of Sub-Fund Assets.
 - Confirmation that Principal Adverse Impacts (PAIs) of investment decisions on sustainability factors are considered through the application of exclusion criteria.
- **What are the objectives of the sustainable investments that the financial product partially intends to make and how does the sustainable investment contribute to such objectives?**

Sustainable investments contribute to environmental and/or social objectives, for which the Investment Manager uses as reference frameworks, among others, the UN Sustainable Development Goals (SDGs), as well as the objectives of the EU Taxonomy:

1. Climate Change Mitigation
2. Climate Change Adaptation
3. Sustainable Use and Protection of Water and Marine Resources
4. Transition to a Circular Economy
5. Pollution Prevention and Control
6. Protection and Restoration of Biodiversity and Ecosystems

The assessment of the positive contribution to the environmental or social objectives is based on a proprietary framework which combines quantitative elements with qualitative inputs from internal research. The methodology applies first a quantitative breakdown of a securities issuer into its business activities. The qualitative element of the framework is an assessment if business activities contribute positively to an environmental or a social objective.

To calculate the positive contribution on the Sub-Fund level the revenue share of each issuer attributable to business activities contributing to environmental and/or social objectives is considered provided the issuer is satisfying the Do No Significant Harm (“DNSH”) and Good Governance principles, and an asset-weighted aggregation is performed as a second step. Moreover, for certain types of securities, which finance specific projects contributing to environmental or social objectives the overall investment is considered to contribute to environmental and/or social objectives, but also for these a DNSH as well as a Good Governance check for issuers is performed.

- **How do the sustainable investments that the financial product partially intends to make, not cause significant harm to any environmental or social sustainable investment objective?**

In order to ensure that Sustainable Investments do not significantly harm any other environmental and/or social objective, the Investment Manager is leveraging the PAI indicators, whereby significance thresholds have been defined to identify significantly harmful issuers. Issuers not meeting the significance threshold can be engaged for a limited time period to remediate the adverse impact. Otherwise, if the issuer does not meet the defined significance thresholds twice subsequently or in case of a failed engagement, it does not pass the DNSH assessment. Investments in securities of issuers which do not pass the DNSH assessment are not counted as sustainable investments.

- *How have the indicators for adverse impacts on sustainability factors been taken into account?*

All mandatory PAI indicators are considered either as part of the application of the exclusion criteria or through thresholds on a sectorial or absolute basis. Significance thresholds have been defined and they refer to qualitative or quantitative criteria.

Recognizing the lack of data coverage for some of the PAI indicators equivalent data points are used to assess PAI indicators when applying the DNSH assessment, when relevant, for the following indicators for corporates: share of non-renewable energy consumption and production, activities negatively affecting biodiversity-sensitive areas, emissions to water, lack of processes and compliance mechanisms to monitor compliance with UNGC principles and OECD Guidelines for Multinational Enterprises; for sovereigns: GHG Intensity and investee countries subject to social violations. In case of securities which finance specific projects contributing to environmental or social objectives equivalent data at project level might be used to ensure that Sustainable Investments do not significantly harm any other environmental and/or social objective. The Investment Manager will strive to increase data coverage for PAI indicators with low data coverage by engaging with issuers and data providers. The Investment Manager will regularly evaluate whether the availability of data has increased sufficiently to potentially include assessment of such data in the investment process.

Principal adverse impacts are the most significant negative impacts of investment decisions on sustainability factors relating to environmental, social and employee matters, respect for human rights, anti-corruption and anti-bribery matters.

- *How are the sustainable investments aligned with the OECD Guidelines for Multinational Enterprises and the UN Guiding Principles on Business and Human Rights? Details:*

The Investment Manager's sustainable minimum exclusion list screens out companies based on their involvement in controversial practices against international norms. The core normative framework consists of the Principles of the UN Global Compact, the OECD Guidelines for Multinational Enterprises and the UN Guiding Principles for Business and Human Rights. Securities issued by companies having a severe violation of these frameworks will be restricted from the investment universe.

The EU Taxonomy sets out a "do not significant harm" principle by which Taxonomy-aligned investments should not significantly harm EU Taxonomy objectives and is accompanied by specific EU criteria.

The "do not significant harm" principle applies only to those investments underlying the financial product that take into account the EU criteria for environmentally sustainable economic activities. The investments underlying the remaining portion of this financial product do not take into account the EU criteria for environmentally sustainable economic activities.

Any other sustainable investments must also not significantly harm any environmental or social objectives.



Does this financial product consider principal adverse impacts on sustainability factors?

Yes

No

The Management Company has joined the Net Zero Asset Manager Initiative and considers PAI indicators through stewardship including engagement, both are relevant to mitigate potential adverse impact as a company.

Due to the commitment to the Net Zero Asset Manager Initiative, the Management Company aims to reduce greenhouse gas emissions in partnership with asset owner clients on decarbonisation goals, consistent with an ambition to reach net zero emission by 2050 or sooner across all assets under management. As part of this objective the Management Company will set an interim target for the proportion of assets to be managed in line with the attainment of net zero emissions by 2050 or sooner.

The Sub-Fund's Investment Manager addresses PAI indicators regarding greenhouse gas emission, biodiversity, water, waste as well as social and employee matters for corporate issuers, and, where relevant, the freedom house index is applied to investments in sovereigns. PAI indicators are considered within the Investment Manager's investment process through the means of exclusions as described in the "binding elements" section of the Sub-Fund.

The data coverage for the data required for the PAI indicators is heterogenous. The data coverage related to biodiversity, water and waste is low and the related PAI indicators are considered through exclusion of securities issued by companies having a severe violation / breach of principles and guidelines such as the Principles of the United Nations Global Compact, the OECD Guidelines for Multinational Enterprises, and the United Nations Guiding Principles for Business and Human Rights on the grounds of problematic practices around human rights, labour rights, environment, and corruption issues. Therefore, the Investment Manager will strive to increase data coverage for PAI indicators with low data coverage. The Investment Manager will regularly evaluate whether the availability of data has increased sufficiently to potentially include assessment of such data in the investment process.

Additionally, the investment Manager considers PAI indicators by limiting its allocation into issuers which significantly harm environmental and/or social objectives.

The following PAI indicators are considered:

Applicable to corporate issuers

- GHG Emissions
- Carbon footprint
- GHG Intensity of investee companies
- Exposure to companies active in the fossil fuel sector
- Activities negatively affecting biodiversity-sensitive areas
- Emissions to water
- Hazardous waste ratio

- Violation of UN Global compact principles
- Lack of processes and compliance mechanisms to monitor compliance with UN Global Compact principles
- Board gender diversity
- Exposure to controversial weapons

Applicable to sovereign and supranational issuers

- Investee countries subject to social violations

The information on the PAI indicators will be available in the end-year report of the Sub-Fund.



What investment strategy does this financial product follow?

The investment strategy guides investment decisions based on factors such as investment objectives and risk tolerance.

Allianz Europe Mid Cap Equity's investment objective is to invest in developed European equity markets, excluding Turkey and Russia, with a focus on mid-sized companies in accordance with the Sustainability Key Performance Indicator Strategy (Absolute Threshold) ("KPI Strategy (Absolute Threshold)"). The Sub-Fund's strategy is to target a specific minimum allocation into Sustainable Investments and limit its allocation to DNSH.

The proportion of assets which do not have a Sustainable Investment share assessment is expected to be low. Examples of instruments not having a Sustainable Investment share assessment are cash and deposits, some Target Funds, and investments for which data is not available.

The Sub-Fund's general investment approach (Sub-Fund's applicable General Asset Class Principles in combination with its individual investment restrictions) is described in the prospectus.

● What are the binding elements of the investment strategy used to select the investments to attain each of the environmental or social characteristics promoted by this financial product?

The investment strategy adheres to the following binding elements to attain the environmental and/ or social characteristics promoted:

- Min. 80% of Sub-Fund's portfolio shall be invested in companies which have been assessed according to the Sustainable Investment methodology (Portfolio in this respect does not comprise derivatives and instruments that are non-evaluated by nature (e. g., cash and deposits)).
- Min. 30% of weighted-average Sustainable Investment share at Sub Fund Assets. If the Investment Manager acquires a use of proceed security, which finance specific projects contributing to environmental or social objectives, the overall investment is considered to contribute to environmental and/or social objectives according to the Sustainable Investment methodology.
- Max. 15% of Sub-Fund assets will be invested in securities from issuers not satisfying the Do No Significant Harm ("DNSH") principles.
- Application of the following sustainable minimum exclusion criteria for direct investments:
 - securities issued by companies having a severe violation / breach of principles and guidelines such as the Principles of the United Nations Global Compact, the OECD Guidelines for Multinational Enterprises, and the United Nations Guiding Principles for Business and Human Rights on the grounds of problematic practices around human rights, labour rights, environment, and corruption,
 - securities issued by companies involved in controversial weapons (anti-personnel mines, cluster munitions, chemical weapons, biological weapons, depleted uranium, white phosphorus, and nuclear weapons),
 - securities issued by companies that derive more than 10% of their revenues from weapons, military equipment, and services,
 - securities issued by companies that derive more than 10% of their revenue from thermal coal extraction
 - securities issued by utility companies that generate more than 20% of their revenues from coal,
 - securities issued by companies involved in the production of tobacco, and securities issued by companies involved in the distribution of tobacco with more than 5% of their revenues.

Direct investments in sovereign issuers with an insufficient freedom house index score are excluded.

The sustainable minimum exclusion criteria are based on information from an external data provider and coded in pre- and post-trade compliance. The review is performed at least half yearly.

- **What is the committed minimum rate to reduce the scope of the investments considered prior to the application of that investment strategy?**

The Sub-Fund does not commit to reduce the scope of the investments by a certain minimum rate.

- **What is the policy to assess good governance practices of the investee companies?**

Good governance principles are considered by screening out companies based on their involvement in controversies around international norms corresponding to the four good governance practices: sound management structures, employee relations, remuneration of staff and tax compliance. Companies having a severe violation in either of those areas will not be investible. For certain cases, flagged issuers shall be on a watch list. These companies will appear on this watch list when the Investment Manager believes that engagement may lead to improvements or when the company is assessed to take remedial actions. Companies on the watch list remain investible unless the Investment Manager believes that the engagement or the remedial actions of the company does not lead to the desired remedy of the severe controversy.

In addition, the Sub-Fund's Investment Manager is committed to actively encourage open dialogues with investee companies on corporate governance, proxy voting and broader sustainability issues in advance of shareholder meetings (regularly for direct investments in shares). The Sub-Fund's Investment Manager's approach to proxy voting and company engagement is set out in the Management Company's Stewardship Statement.

Good governance practices include sound management structures, employee relations, remuneration of staff and tax compliance.



What is the asset allocation planned for this financial product?

Asset allocation describes the share of investments in specific assets.

Min. 80% of the Sub-Funds' assets (excluding cash, and derivatives) are used to meet the environmental or social characteristics promoted by this Sub-Fund. A low portion of the Sub-Fund might contain assets which do not promote environmental or social characteristics. Example of such instruments are derivatives, cash and deposits, some Target Funds and investment with temporarily divergent or absent environmental, social, or good governance qualifications. Min. 30% of the Sub-Funds' assets will be invested in Sustainable Investments. The minimum percentage of investments that are aligned with the EU Taxonomy is 0.01%. The Sub-Fund's Investment Manager does not commit to a minimum share of environmentally Sustainable Investments that are not aligned with the EU Taxonomy. The Sub-Fund's Investment Manager does not commit to a minimum share of socially sustainable investments. While the Sub-Fund cannot commit to a minimum share of environmentally or socially sustainable investments, such investments may be freely allocated to within the Sub-Fund aggregated sustainable investment commitment disclosed (min. 30%).

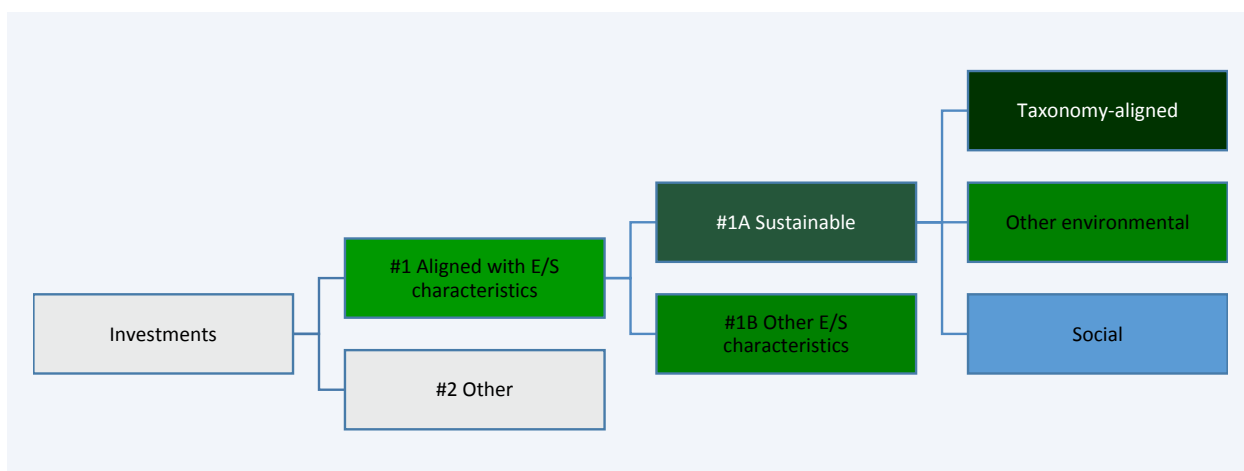

#1 Aligned with E/S characteristics includes the investments of the financial product used to attain the environmental or social characteristics promoted by the financial product.

#2 Other includes the remaining investments of the financial product which are neither aligned with the environmental or social characteristics, nor are qualified as sustainable investments.

The category **#1 Aligned with E/S characteristics** covers:

- The sub-category **#1A Sustainable** covers sustainable investments with environmental or social objectives.
- The sub-category **#1B Other E/S characteristics** covers investments aligned with the environmental or social characteristics that do not qualify as sustainable investments.

- **How does the use of derivatives attain the environmental or social characteristics promoted by the financial product?**

Not applicable



To what minimum extent are sustainable investments with an environmental objective aligned with the EU Taxonomy?

The Taxonomy-aligned investments include debt and/or equity in environmentally sustainable economic activities aligned with the EU-Taxonomy. The minimum percentage of investments that are aligned with the EU Taxonomy is 0.01%. Taxonomy-aligned data is provided by an external data provider. The Investment Manager has assessed the quality of such data. The data will not be subject to an assurance provided by auditors or a review by third parties. The data will not reflect any data in government bonds. As of today, there is no recognized methodology available to determine the proportion of Taxonomy-aligned activities when investing in government bonds.

Taxonomy-aligned activities in this disclosure are based on share of turnover. Pre-contractual figures use turnover as its financial metric as a default in line with the regulatory requirements and based on the fact that complete, verifiable or up-to date data for CAPEX and/or OPEX as financial metric is even less available.

Taxonomy-aligned data is only in rare cases data reported by companies in accordance with the EU Taxonomy. The data provider has derived Taxonomy-aligned data from other available equivalent public data.

- **Does the financial product invest in fossil gas and/or nuclear energy related activities that comply with the EU Taxonomy ^{1?}**

Yes:
 In fossil gas In nuclear energy
 No

The Sub-Fund does not pursue any investments in fossil gas and/or nuclear energy related activities that comply with the EU Taxonomy. Nevertheless, as result of this investment strategy, investments may occur in corporates which are also active in these activities. Further information will be provided as part of the annual reporting, if relevant.

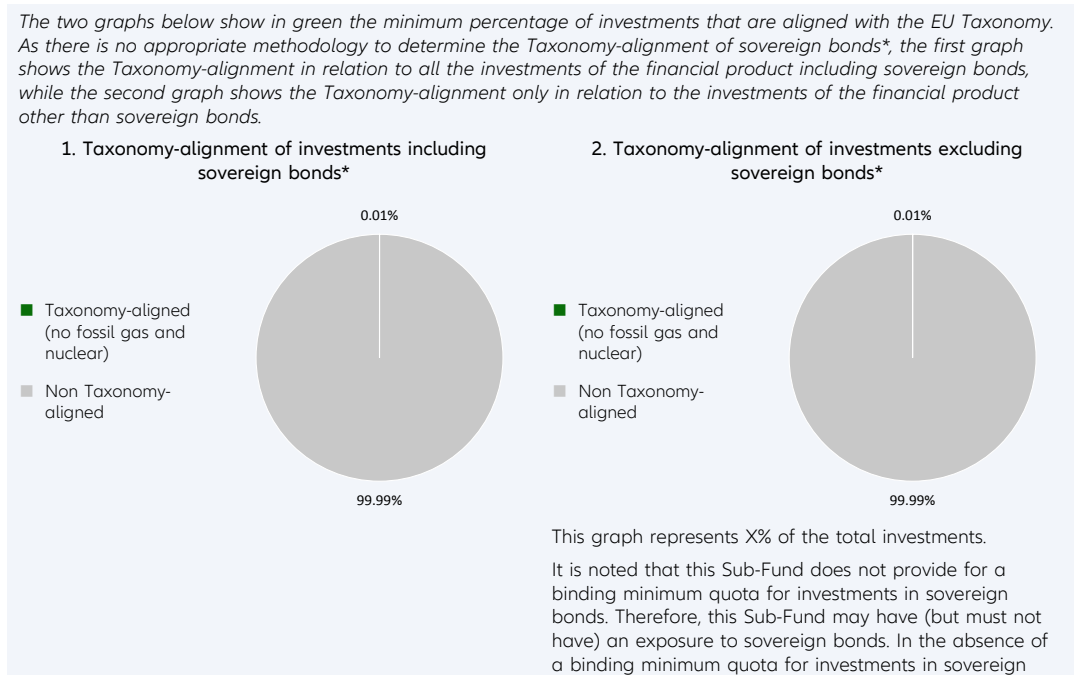

Taxonomy-aligned activities are expressed as a share of:
 - **turnover** reflecting the share of revenue from green activities of investee companies
 - **capital expenditure** (CapEx) showing the green investments made by investee companies, e.g. for a transition to a green economy.
 - **operational expenditure** (OpEx) reflecting green operational activities of investee companies.

¹ Fossil gas and/or nuclear related activities will only comply with the EU Taxonomy where they contribute to limiting climate change ("climate change mitigation") and do not significantly harm any EU Taxonomy objective - see explanatory note in the left hand margin. The full criteria for fossil gas and nuclear energy economic activities that comply with the EU Taxonomy are laid down in Commission Delegated Regulation (EU) 2022/1214.

bonds, this graph does not generate any additional added value compared to the left-hand graph.

* For the purpose of these graphs, 'sovereign bonds' consist of all sovereign exposures

Enabling activities directly enable other activities to make a substantial contribution to an environmental objective.

Transitional activities are activities for which low-carbon alternatives are not yet available and among others have greenhouse gas emission levels corresponding to the best performance.

● **What is the minimum share of investments in transitional and enabling activities?**

The Sub-Fund's Investment Manager does not commit to a split of minimum taxonomy alignment into transitional, enabling activities and own performance.



What is the minimum share of sustainable investments with an environmental objective that are not aligned with the EU Taxonomy?

Taxonomy-aligned investments are considered a sub-category of Sustainable Investments. If an investment is not Taxonomy-aligned since the activity is not yet covered under the EU Taxonomy or the positive contribution is not substantial enough to comply with the Taxonomy technical screening criteria, the investment can still be considered an environmentally Sustainable Investment provided it complies with all criteria. The Investment Manager does not commit to a minimum share of environmentally Sustainable Investments that are not aligned with the EU Taxonomy. The overall sustainable investment share may also include investments with an environmental objective in economic activities that do not qualify as environmentally sustainable under the EU Taxonomy, and while the Sub-Fund cannot commit to a minimum share of environmentally or socially sustainable investments, such investments may be freely allocated to within the Sub-Fund aggregated sustainable investment commitment disclosed (min 30%).



are sustainable investments with an environmental objective that **do not take into account the criteria** for environmentally sustainable economic activities under the EU Taxonomy.



What is the minimum share of socially sustainable investments?

The Investment Manager defines Sustainable Investments based on internal research, which uses, among others, the UN Sustainable Development Goals (SDGs), as well as the objectives of the EU Taxonomy as reference frameworks. The Investment Manager does not commit to a minimum share of socially Sustainable Investments, as the SDGs contain environmental as well as social objectives. The overall sustainable investment share may also include investments with a social objective, and while the Sub-Fund cannot commit to a minimum share of environmentally or socially sustainable investments, such investments may be freely allocated to within the Sub-Fund aggregated sustainable investment commitment disclosed (min 30%).



What investments are included under “#2 Other”, what is their purpose and are there any minimum environmental or social safeguards?

Under “#2 Other” investments into cash, Target Funds, or derivatives can be included. Derivatives might be used for efficient portfolio management (including risk hedging) and/or investment purposes, and Target Funds to benefit from a specific strategy. For those investments no environmental or social safeguards are applied.



Is a specific index designated as a reference benchmark to determine whether this financial product is aligned with the environmental and/or social characteristics that it promotes?

No reference benchmark has been designated for the purpose of attaining the environmental and/or social characteristics promoted by the Sub-Fund.

Reference benchmarks are indexes to measure whether the financial product attains the environmental or social characteristics that they promote.

- **How is the reference benchmark continuously aligned with each of the environmental or social characteristics promoted by the financial product?**
Not applicable
- **How is the alignment of the investment strategy with the methodology of the index ensured on a continuous basis?**
Not applicable
- **How does the designated index differ from a relevant broad market index?**
Not applicable
- **Where can the methodology used for the calculation of the designated index be found?**
Not applicable



Where can I find more product specific information online?

More product-specific information can be found on the website: <https://regulatory.allianzgi.com/SFDR>

Template pre-contractual disclosure for the financial products referred to in Article 8, paragraphs 1, 2 and 2a, of Regulation (EU) 2019/2088 and Article 6, first paragraph, of Regulation (EU) 2020/852

Product name:

Allianz Europe Small and Micro Cap Equity

Legal entity identifier: 52990079B3RQSR4XZV91

Environmental and/or social characteristics

Sustainable investment means an investment in an economic activity that contributes to an environmental or social objective, provided that the investment does not significantly harm any environmental or social objective and that the investee companies follow good governance practices.

The **EU Taxonomy** is a classification system laid down in Regulation (EU) 2020/852, establishing a list of **environmentally sustainable economic activities**. That Regulation does not include a list of socially sustainable economic activities. Sustainable investments with an environmental objective might be aligned with the Taxonomy or not.

Does this financial product have a sustainable investment objective?	
Yes	No
<input type="checkbox"/> It will make a minimum of sustainable investments with an environmental objective : ____% <input type="checkbox"/> in economic activities that qualify as environmentally sustainable under the EU Taxonomy <input type="checkbox"/> in economic activities that do not qualify as environmentally sustainable under the EU Taxonomy	<input checked="" type="checkbox"/> It promotes Environmental/Social (E/S) characteristics and while it does not have as its objective a sustainable investment, it will have a minimum proportion of 20.00% of sustainable investments <input checked="" type="checkbox"/> with an environmental objective in economic activities that qualify as environmentally sustainable under the EU Taxonomy <input checked="" type="checkbox"/> with an environmental objective in economic activities that do not qualify as environmentally sustainable under the EU Taxonomy <input checked="" type="checkbox"/> with a social objective
<input type="checkbox"/> It will make a minimum of sustainable investments with a social objective ____%	<input type="checkbox"/> It promotes E/S characteristics, but will not make any sustainable investments



What environmental and/or social characteristics are promoted by this financial product?

Allianz Europe Small and Micro Cap Equity (the "Sub-Fund") is managed according to the Sustainability Key Performance Indicator Strategy (Absolute Threshold) ("KPI Strategy (Absolute Threshold)") which targets a specific minimum allocation into Sustainable Investments. Sustainable investments are investments in economic activities which contribute to environmental and/or social objectives, for which the Investment Managers uses as reference frameworks the UN Sustainable Development Goals (SDGs), as well as the objectives of the EU Taxonomy.

Furthermore, the Sub-Fund will limit its allocation into issuers which significantly harm environmental and/or social objectives.

In addition, sustainable minimum exclusion criteria apply.

No reference benchmark has been designated for the purpose of attaining the environmental and/or social characteristics promoted by the Sub-Fund.

● What sustainability indicators are used to measure the attainment of each of the environmental or social characteristics promoted by this financial product?

To measure the attainment of the environmental and/or social characteristics the following sustainability indicators are used and reported on, at the fiscal year end:

- The actual percentage of KPI coverage of the Sub-Fund's Portfolio (Portfolio in this respect does not comprise derivatives and instruments that are non-evaluated by nature (e. g., cash and deposits)).

Sustainability indicators measure how the environmental or social characteristics promoted by the financial product are attained.

- The actual weighted average sustainable investment share of Sub-Fund Assets.
 - The actual share of investments not satisfying the Do No Significant Harm (“DNSH”) assessment of Sub-Fund Assets.
 - Confirmation that Principal Adverse Impacts (PAIs) of investment decisions on sustainability factors are considered through the application of exclusion criteria.
- **What are the objectives of the sustainable investments that the financial product partially intends to make and how does the sustainable investment contribute to such objectives?**

Sustainable investments contribute to environmental and/or social objectives, for which the Investment Manager uses as reference frameworks, among others, the UN Sustainable Development Goals (SDGs), as well as the objectives of the EU Taxonomy:

1. Climate Change Mitigation
2. Climate Change Adaptation
3. Sustainable Use and Protection of Water and Marine Resources
4. Transition to a Circular Economy
5. Pollution Prevention and Control
6. Protection and Restoration of Biodiversity and Ecosystems

The assessment of the positive contribution to the environmental or social objectives is based on a proprietary framework which combines quantitative elements with qualitative inputs from internal research. The methodology applies first a quantitative breakdown of a securities issuer into its business activities. The qualitative element of the framework is an assessment if business activities contribute positively to an environmental or a social objective.

To calculate the positive contribution on the Sub-Fund level the revenue share of each issuer attributable to business activities contributing to environmental and/or social objectives is considered provided the issuer is satisfying the Do No Significant Harm (“DNSH”) and Good Governance principles, and an asset-weighted aggregation is performed as a second step. Moreover, for certain types of securities, which finance specific projects contributing to environmental or social objectives the overall investment is considered to contribute to environmental and/or social objectives, but also for these a DNSH as well as a Good Governance check for issuers is performed.

- **How do the sustainable investments that the financial product partially intends to make, not cause significant harm to any environmental or social sustainable investment objective?**

In order to ensure that Sustainable Investments do not significantly harm any other environmental and/or social objective, the Investment Manager is leveraging the PAI indicators, whereby significance thresholds have been defined to identify significantly harmful issuers. Issuers not meeting the significance threshold can be engaged for a limited time period to remediate the adverse impact. Otherwise, if the issuer does not meet the defined significance thresholds twice subsequently or in case of a failed engagement, it does not pass the DNSH assessment. Investments in securities of issuers which do not pass the DNSH assessment are not counted as sustainable investments.

- *How have the indicators for adverse impacts on sustainability factors been taken into account?*

All mandatory PAI indicators are considered either as part of the application of the exclusion criteria or through thresholds on a sectorial or absolute basis. Significance thresholds have been defined and they refer to qualitative or quantitative criteria.

Recognizing the lack of data coverage for some of the PAI indicators equivalent data points are used to assess PAI indicators when applying the DNSH assessment, when relevant, for the following indicators for corporates: share of non-renewable energy consumption and production, activities negatively affecting biodiversity-sensitive areas, emissions to water, lack of processes and compliance mechanisms to monitor compliance with UNGC principles and OECD Guidelines for Multinational Enterprises; for sovereigns: GHG Intensity and investee countries subject to social violations. In case of securities which finance specific projects contributing to environmental or social objectives equivalent data at project level might be used to ensure that Sustainable Investments do not significantly harm any other environmental and/or social objective. The Investment Manager will strive to increase data coverage for PAI indicators with low data coverage by engaging with issuers and data providers. The Investment

Principal adverse impacts are the most significant negative impacts of investment decisions on sustainability factors relating to environmental, social and employee matters, respect for human rights, anti-corruption and anti-bribery matters.

Manager will regularly evaluate whether the availability of data has increased sufficiently to potentially include assessment of such data in the investment process.

● *How are the sustainable investments aligned with the OECD Guidelines for Multinational Enterprises and the UN Guiding Principles on Business and Human Rights? Details:*

The Investment Manager's sustainable minimum exclusion list screens out companies based on their involvement in controversial practices against international norms. The core normative framework consists of the Principles of the UN Global Compact, the OECD Guidelines for Multinational Enterprises and the UN Guiding Principles for Business and Human Rights. Securities issued by companies having a severe violation of these frameworks will be restricted from the investment universe.

The EU Taxonomy sets out a "do not significant harm" principle by which Taxonomy-aligned investments should not significantly harm EU Taxonomy objectives and is accompanied by specific EU criteria.

The "do not significant harm" principle applies only to those investments underlying the financial product that take into account the EU criteria for environmentally sustainable economic activities. The investments underlying the remaining portion of this financial product do not take into account the EU criteria for environmentally sustainable economic activities.

Any other sustainable investments must also not significantly harm any environmental or social objectives.



Does this financial product consider principal adverse impacts on sustainability factors?

Yes

No

The Management Company has joined the Net Zero Asset Manager Initiative and considers PAI indicators through stewardship including engagement, both are relevant to mitigate potential adverse impact as a company.

Due to the commitment to the Net Zero Asset Manager Initiative, the Management Company aims to reduce greenhouse gas emissions in partnership with asset owner clients on decarbonisation goals, consistent with an ambition to reach net zero emission by 2050 or sooner across all assets under management. As part of this objective the Management Company will set an interim target for the proportion of assets to be managed in line with the attainment of net zero emissions by 2050 or sooner.

The Sub-Fund's Investment Manager addresses PAI indicators regarding greenhouse gas emission, biodiversity, water, waste as well as social and employee matters for corporate issuers, and, where relevant, the freedom house index is applied to investments in sovereigns. PAI indicators are considered within the Investment Manager's investment process through the means of exclusions as described in the "binding elements" section of the Sub-Fund.

The data coverage for the data required for the PAI indicators is heterogenous. The data coverage related to biodiversity, water and waste is low and the related PAI indicators are considered through exclusion of securities issued by companies having a severe violation / breach of principles and guidelines such as the Principles of the United Nations Global Compact, the OECD Guidelines for Multinational Enterprises, and the United Nations Guiding Principles for Business and Human Rights on the grounds of problematic practices around human rights, labour rights, environment, and corruption issues. Therefore, the Investment Manager will strive to increase data coverage for PAI indicators with low data coverage. The Investment Manager will regularly evaluate whether the availability of data has increased sufficiently to potentially include assessment of such data in the investment process.

Additionally, the investment Manager considers PAI indicators by limiting its allocation into issuers which significantly harm environmental and/or social objectives.

The following PAI indicators are considered:

Applicable to corporate issuers

- GHG Emissions
- Carbon footprint
- GHG Intensity of investee companies
- Exposure to companies active in the fossil fuel sector
- Activities negatively affecting biodiversity-sensitive areas

- Emissions to water
- Hazardous waste ratio
- Violation of UN Global compact principles
- Lack of processes and compliance mechanisms to monitor compliance with UN Global Compact principles
- Board gender diversity
- Exposure to controversial weapons

Applicable to sovereign and supranational issuers

- Investee countries subject to social violations

The information on the PAI indicators will be available in the end-year report of the Sub-Fund.



The investment strategy guides investment decisions based on factors such as investment objectives and risk tolerance.

What investment strategy does this financial product follow?

Allianz Europe Small and Micro Cap Equity's investment objective is to invest in European equity markets with a focus on micro to small cap companies in accordance with the Sustainability Key Performance Indicator Strategy (Absolute Threshold) ("KPI Strategy (Absolute Threshold)"). The Sub-Fund's strategy is to target a specific minimum allocation into Sustainable Investments and limit its allocation to DNSH.

The proportion of assets which do not have a Sustainable Investment share assessment is expected to be low. Examples of instruments not having a Sustainable Investment share assessment are cash and deposits, some Target Funds, and investments for which data is not available.

The Sub-Fund's general investment approach (Sub-Fund's applicable General Asset Class Principles in combination with its individual investment restrictions) is described in the prospectus.

● What are the binding elements of the investment strategy used to select the investments to attain each of the environmental or social characteristics promoted by this financial product?

The investment strategy adheres to the following binding elements to attain the environmental and/ or social characteristics promoted:

- Min. 70% of Sub-Fund's portfolio shall be invested in companies which have been assessed according to the Sustainable Investment methodology (Portfolio in this respect does not comprise derivatives and instruments that are non-evaluated by nature (e. g., cash and deposits)).
- Min. 20% of weighted-average Sustainable Investment share at Sub Fund Assets. If the Investment Manager acquires a use of proceed security, which finance specific projects contributing to environmental or social objectives, the overall investment is considered to contribute to environmental and/or social objectives according to the Sustainable Investment methodology.
- Max. 10% of Sub-Fund assets will be invested in securities from issuers not satisfying the Do No Significant Harm ("DNSH") principles.- Application of the following sustainable minimum exclusion criteria for direct investments:
 - securities issued by companies having a severe violation / breach of principles and guidelines such as the Principles of the United Nations Global Compact, the OECD Guidelines for Multinational Enterprises, and the United Nations Guiding Principles for Business and Human Rights on the grounds of problematic practices around human rights, labour rights, environment, and corruption,
 - securities issued by companies involved in controversial weapons (anti-personnel mines, cluster munitions, chemical weapons, biological weapons, depleted uranium, white phosphorus, and nuclear weapons),
 - securities issued by companies that derive more than 10% of their revenues from weapons, military equipment, and services,
 - securities issued by companies that derive more than 10% of their revenue from thermal coal extraction
 - securities issued by utility companies that generate more than 20% of their revenues from coal,
 - securities issued by companies involved in the production of tobacco, and securities issued by companies involved in the distribution of tobacco with more than 5% of their revenues.

Direct investments in sovereign issuers with an insufficient freedom house index score are excluded.

The sustainable minimum exclusion criteria are based on information from an external data provider and coded in pre- and post-trade compliance. The review is performed at least half yearly.

● **What is the committed minimum rate to reduce the scope of the investments considered prior to the application of that investment strategy?**

The Sub-Fund does not commit to reduce the scope of the investments by a certain minimum rate.

● **What is the policy to assess good governance practices of the investee companies?**

Good governance principles are considered by screening out companies based on their involvement in controversies around international norms corresponding to the four good governance practices: sound management structures, employee relations, remuneration of staff and tax compliance. Companies having a severe violation in either of those areas will not be investible. For certain cases, flagged issuers shall be on a watch list. These companies will appear on this watch list when the Investment Manager believes that engagement may lead to improvements or when the company is assessed to take remedial actions. Companies on the watch list remain investible unless the Investment Manager believes that the engagement or the remedial actions of the company does not lead to the desired remedy of the severe controversy.

In addition, the Sub-Fund's Investment Manager is committed to actively encourage open dialogues with investee companies on corporate governance, proxy voting and broader sustainability issues in advance of shareholder meetings (regularly for direct investments in shares). The Sub-Fund's Investment Manager's approach to proxy voting and company engagement is set out in the Management Company's Stewardship Statement.

Good governance practices include sound management structures, employee relations, remuneration of staff and tax compliance.



What is the asset allocation planned for this financial product?

Asset allocation describes the share of investments in specific assets.

Min. 70% of the Sub-Funds' assets (excluding cash, and derivatives) are used to meet the environmental or social characteristics promoted by this Sub-Fund. A low portion of the Sub-Fund might contain assets which do not promote environmental or social characteristics. Example of such instruments are derivatives, cash and deposits, some Target Funds and investment with temporarily divergent or absent environmental, social, or good governance qualifications. Min. 20% of the Sub-Funds' assets will be invested in Sustainable Investments. The minimum percentage of investments that are aligned with the EU Taxonomy is 0.01%. The Sub-Fund's Investment Manager does not commit to a minimum share of environmentally Sustainable Investments that are not aligned with the EU Taxonomy. The Sub-Fund's Investment Manager does not commit to a minimum share of socially sustainable investments. While the Sub-Fund cannot commit to a minimum share of environmentally or socially sustainable investments, such investments may be freely allocated to within the Sub-Fund aggregated sustainable investment commitment disclosed (min. 20%).

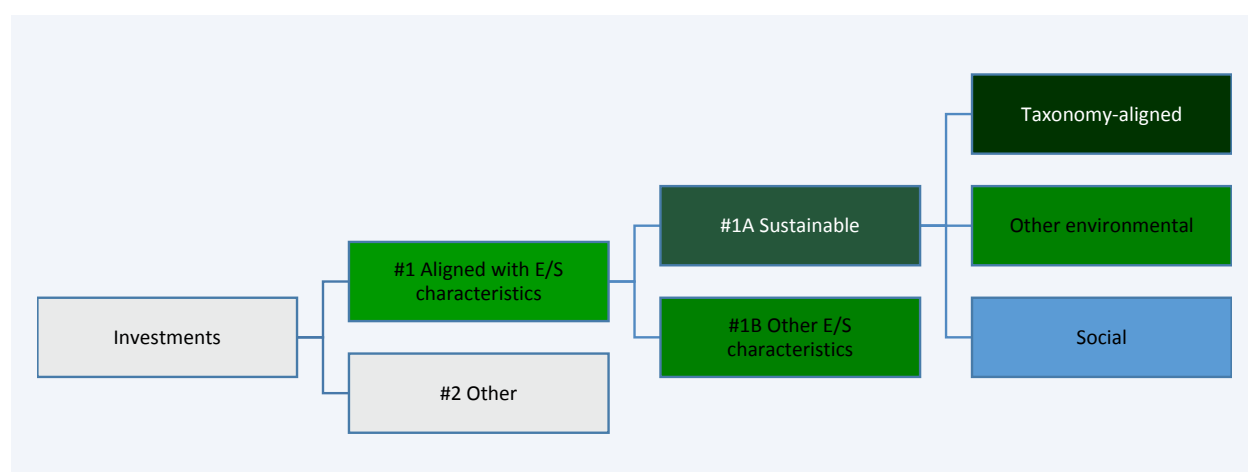

#1 Aligned with E/S characteristics includes the investments of the financial product used to attain the environmental or social characteristics promoted by the financial product.

#2 Other includes the remaining investments of the financial product which are neither aligned with the environmental or social characteristics, nor are qualified as sustainable investments.

The category **#1 Aligned with E/S characteristics** covers:

- The sub-category **#1A Sustainable** covers sustainable investments with environmental or social objectives.
- The sub-category **#1B Other E/S characteristics** covers investments aligned with the environmental or social characteristics that do not qualify as sustainable investments.

- **How does the use of derivatives attain the environmental or social characteristics promoted by the financial product?**

Not applicable



To what minimum extent are sustainable investments with an environmental objective aligned with the EU Taxonomy?

The Taxonomy-aligned investments include debt and/or equity in environmentally sustainable economic activities aligned with the EU-Taxonomy. The minimum percentage of investments that are aligned with the EU Taxonomy is 0.01%. Taxonomy-aligned data is provided by an external data provider. The Investment Manager has assessed the quality of such data. The data will not be subject to an assurance provided by auditors or a review by third parties. The data will not reflect any data in government bonds. As of today, there is no recognized methodology available to determine the proportion of Taxonomy-aligned activities when investing in government bonds.

Taxonomy-aligned activities in this disclosure are based on share of turnover. Pre-contractual figures use turnover as its financial metric as a default in line with the regulatory requirements and based on the fact that complete, verifiable or up-to date data for CAPEX and/or OPEX as financial metric is even less available.

Taxonomy-aligned data is only in rare cases data reported by companies in accordance with the EU Taxonomy. The data provider has derived Taxonomy-aligned data from other available equivalent public data.

- **Does the financial product invest in fossil gas and/or nuclear energy related activities that comply with the EU Taxonomy ¹?**

Yes:
 In fossil gas In nuclear energy

No

The Sub-Fund does not pursue any investments in fossil gas and/or nuclear energy related activities that comply with the EU Taxonomy. Nevertheless, as result of this investment strategy, investments may occur in corporates which are also active in these activities. Further information will be provided as part of the annual reporting, if relevant.

Taxonomy-aligned activities are expressed as a share of:
 - **turnover** reflecting the share of revenue from green activities of investee companies
 - **capital expenditure (CapEx)** showing the green investments made by investee companies, e.g. for a transition to a green economy.
 - **operational expenditure (OpEx)** reflecting green operational activities of investee companies.

The two graphs below show in green the minimum percentage of investments that are aligned with the EU Taxonomy. As there is no appropriate methodology to determine the Taxonomy-alignment of sovereign bonds, the first graph shows the Taxonomy-alignment in relation to all the investments of the financial product including sovereign bonds, while the second graph shows the Taxonomy-alignment only in relation to the investments of the financial product other than sovereign bonds.*

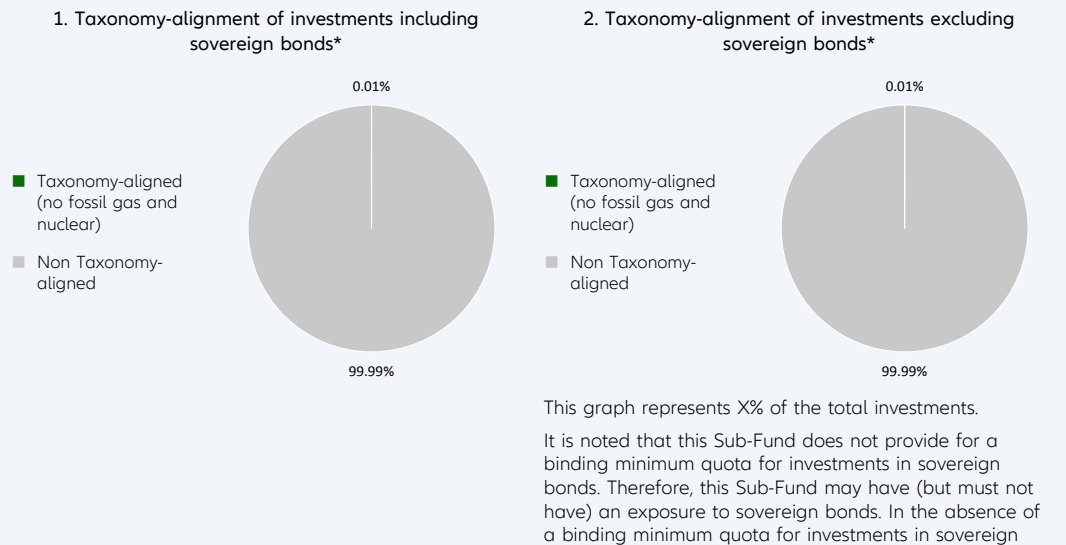

¹ Fossil gas and/or nuclear related activities will only comply with the EU Taxonomy where they contribute to limiting climate change ("climate change mitigation") and do not significantly harm any EU Taxonomy objective - see explanatory note in the left hand margin. The full criteria for fossil gas and nuclear energy economic activities that comply with the EU Taxonomy are laid down in Commission Delegated Regulation (EU) 2022/1214.

bonds, this graph does not generate any additional added value compared to the left-hand graph.

* For the purpose of these graphs, 'sovereign bonds' consist of all sovereign exposures

Enabling activities directly enable other activities to make a substantial contribution to an environmental objective.

Transitional activities are activities for which low-carbon alternatives are not yet available and among others have greenhouse gas emission levels corresponding to the best performance.

● **What is the minimum share of investments in transitional and enabling activities?**

The Sub-Fund's Investment Manager does not commit to a split of minimum taxonomy alignment into transitional, enabling activities and own performance.



What is the minimum share of sustainable investments with an environmental objective that are not aligned with the EU Taxonomy?

Taxonomy-aligned investments are considered a sub-category of Sustainable Investments. If an investment is not Taxonomy-aligned since the activity is not yet covered under the EU Taxonomy or the positive contribution is not substantial enough to comply with the Taxonomy technical screening criteria, the investment can still be considered an environmentally Sustainable Investment provided it complies with all criteria. The Investment Manager does not commit to a minimum share of environmentally Sustainable Investments that are not aligned with the EU Taxonomy. The overall sustainable investment share may also include investments with an environmental objective in economic activities that do not qualify as environmentally sustainable under the EU Taxonomy, and while the Sub-Fund cannot commit to a minimum share of environmentally or socially sustainable investments, such investments may be freely allocated to within the Sub-Fund aggregated sustainable investment commitment disclosed (min 20%).



are sustainable investments with an environmental objective that **do not take into account the criteria** for environmentally sustainable economic activities under the EU Taxonomy.



What is the minimum share of socially sustainable investments?

The Investment Manager defines Sustainable Investments based on internal research, which uses, among others, the UN Sustainable Development Goals (SDGs), as well as the objectives of the EU Taxonomy as reference frameworks. The Investment Manager does not commit to a minimum share of socially Sustainable Investments, as the SDGs contain environmental as well as social objectives. The overall sustainable investment share may also include investments with a social objective, and while the Sub-Fund cannot commit to a minimum share of environmentally or socially sustainable investments, such investments may be freely allocated to within the Sub-Fund aggregated sustainable investment commitment disclosed (min 20%).



What investments are included under “#2 Other”, what is their purpose and are there any minimum environmental or social safeguards?

Under “#2 Other” investments into cash, Target Funds, or derivatives can be included. Derivatives might be used for efficient portfolio management (including risk hedging) and/or investment purposes, and Target Funds to benefit from a specific strategy. For those investments no environmental or social safeguards are applied.



Is a specific index designated as a reference benchmark to determine whether this financial product is aligned with the environmental and/or social characteristics that it promotes?

No reference benchmark has been designated for the purpose of attaining the environmental and/or social characteristics promoted by the Sub-Fund.

Reference benchmarks are indexes to measure whether the financial product attains the environmental or social characteristics that they promote.

- **How is the reference benchmark continuously aligned with each of the environmental or social characteristics promoted by the financial product?**
Not applicable
- **How is the alignment of the investment strategy with the methodology of the index ensured on a continuous basis?**
Not applicable
- **How does the designated index differ from a relevant broad market index?**
Not applicable
- **Where can the methodology used for the calculation of the designated index be found?**
Not applicable



Where can I find more product specific information online?

More product-specific information can be found on the website: <https://regulatory.allianzgi.com/SFDR>

Template pre-contractual disclosure for the financial products referred to in Article 8, paragraphs 1, 2 and 2a, of Regulation (EU) 2019/2088 and Article 6, first paragraph, of Regulation (EU) 2020/852

Product name:

Allianz Europe Small Cap Equity

Legal entity identifier: 5299004KPSJLVX3ZMU87

Environmental and/or social characteristics

Sustainable investment means an investment in an economic activity that contributes to an environmental or social objective, provided that the investment does not significantly harm any environmental or social objective and that the investee companies follow good governance practices.

The **EU Taxonomy** is a classification system laid down in Regulation (EU) 2020/852, establishing a list of **environmentally sustainable economic activities**. That Regulation does not include a list of socially sustainable economic activities. Sustainable investments with an environmental objective might be aligned with the Taxonomy or not.

Does this financial product have a sustainable investment objective?	
Yes	No
<input type="checkbox"/> It will make a minimum of sustainable investments with an environmental objective : ____% <input type="checkbox"/> in economic activities that qualify as environmentally sustainable under the EU Taxonomy <input type="checkbox"/> in economic activities that do not qualify as environmentally sustainable under the EU Taxonomy	<input checked="" type="checkbox"/> It promotes Environmental/Social (E/S) characteristics and while it does not have as its objective a sustainable investment, it will have a minimum proportion of 20.00% of sustainable investments <input checked="" type="checkbox"/> with an environmental objective in economic activities that qualify as environmentally sustainable under the EU Taxonomy <input checked="" type="checkbox"/> with an environmental objective in economic activities that do not qualify as environmentally sustainable under the EU Taxonomy <input checked="" type="checkbox"/> with a social objective
<input type="checkbox"/> It will make a minimum of sustainable investments with a social objective ____%	<input type="checkbox"/> It promotes E/S characteristics, but will not make any sustainable investments



What environmental and/or social characteristics are promoted by this financial product?

Allianz Europe Small Cap Equity (the "Sub-Fund") is managed according to the Sustainability Key Performance Indicator Strategy (Absolute Threshold) ("KPI Strategy (Absolute Threshold)") which targets a specific minimum allocation into Sustainable Investments. Sustainable investments are investments in economic activities which contribute to environmental and/or social objectives, for which the Investment Managers uses as reference frameworks the UN Sustainable Development Goals (SDGs), as well as the objectives of the EU Taxonomy.

Furthermore, the Sub-Fund will limit its allocation into issuers which significantly harm environmental and/or social objectives.

In addition, sustainable minimum exclusion criteria apply.

No reference benchmark has been designated for the purpose of attaining the environmental and/or social characteristics promoted by the Sub-Fund.

● What sustainability indicators are used to measure the attainment of each of the environmental or social characteristics promoted by this financial product?

To measure the attainment of the environmental and/or social characteristics the following sustainability indicators are used and reported on, at the fiscal year end:

- The actual percentage of KPI coverage of the Sub-Fund's Portfolio (Portfolio in this respect does not comprise derivatives and instruments that are non-evaluated by nature (e. g., cash and deposits)).
- The actual weighted average sustainable investment share of Sub-Fund Assets.

Sustainability indicators measure how the environmental or social characteristics promoted by the financial product are attained.

- The actual share of investments not satisfying the Do No Significant Harm (“DNSH”) assessment of Sub-Fund Assets.
 - Confirmation that Principal Adverse Impacts (PAIs) of investment decisions on sustainability factors are considered through the application of exclusion criteria.
- **What are the objectives of the sustainable investments that the financial product partially intends to make and how does the sustainable investment contribute to such objectives?**

Sustainable investments contribute to environmental and/or social objectives, for which the Investment Manager uses as reference frameworks, among others, the UN Sustainable Development Goals (SDGs), as well as the objectives of the EU Taxonomy:

1. Climate Change Mitigation
2. Climate Change Adaptation
3. Sustainable Use and Protection of Water and Marine Resources
4. Transition to a Circular Economy
5. Pollution Prevention and Control
6. Protection and Restoration of Biodiversity and Ecosystems

The assessment of the positive contribution to the environmental or social objectives is based on a proprietary framework which combines quantitative elements with qualitative inputs from internal research. The methodology applies first a quantitative breakdown of a securities issuer into its business activities. The qualitative element of the framework is an assessment if business activities contribute positively to an environmental or a social objective.

To calculate the positive contribution on the Sub-Fund level the revenue share of each issuer attributable to business activities contributing to environmental and/or social objectives is considered provided the issuer is satisfying the Do No Significant Harm (“DNSH”) and Good Governance principles, and an asset-weighted aggregation is performed as a second step. Moreover, for certain types of securities, which finance specific projects contributing to environmental or social objectives the overall investment is considered to contribute to environmental and/or social objectives, but also for these a DNSH as well as a Good Governance check for issuers is performed.

- **How do the sustainable investments that the financial product partially intends to make, not cause significant harm to any environmental or social sustainable investment objective?**

In order to ensure that Sustainable Investments do not significantly harm any other environmental and/or social objective, the Investment Manager is leveraging the PAI indicators, whereby significance thresholds have been defined to identify significantly harmful issuers. Issuers not meeting the significance threshold can be engaged for a limited time period to remediate the adverse impact. Otherwise, if the issuer does not meet the defined significance thresholds twice subsequently or in case of a failed engagement, it does not pass the DNSH assessment. Investments in securities of issuers which do not pass the DNSH assessment are not counted as sustainable investments.

- **How have the indicators for adverse impacts on sustainability factors been taken into account?**

All mandatory PAI indicators are considered either as part of the application of the exclusion criteria or through thresholds on a sectorial or absolute basis. Significance thresholds have been defined and they refer to qualitative or quantitative criteria.

Recognizing the lack of data coverage for some of the PAI indicators equivalent data points are used to assess PAI indicators when applying the DNSH assessment, when relevant, for the following indicators for corporates: share of non-renewable energy consumption and production, activities negatively affecting biodiversity-sensitive areas, emissions to water, lack of processes and compliance mechanisms to monitor compliance with UNGC principles and OECD Guidelines for Multinational Enterprises; for sovereigns: GHG Intensity and investee countries subject to social violations. In case of securities which finance specific projects contributing to environmental or social objectives equivalent data at project level might be used to ensure that Sustainable Investments do not significantly harm any other environmental and/or social objective. The Investment Manager will strive to increase data coverage for PAI indicators with low data coverage by engaging with issuers and data providers. The Investment Manager will regularly evaluate whether the availability of data has increased sufficiently to potentially include assessment of such data in the investment process.

Principal adverse impacts are the most significant negative impacts of investment decisions on sustainability factors relating to environmental, social and employee matters, respect for human rights, anti-corruption and anti-bribery matters.

- *How are the sustainable investments aligned with the OECD Guidelines for Multinational Enterprises and the UN Guiding Principles on Business and Human Rights? Details:*

The Investment Manager's sustainable minimum exclusion list screens out companies based on their involvement in controversial practices against international norms. The core normative framework consists of the Principles of the UN Global Compact, the OECD Guidelines for Multinational Enterprises and the UN Guiding Principles for Business and Human Rights. Securities issued by companies having a severe violation of these frameworks will be restricted from the investment universe.

The EU Taxonomy sets out a "do not significant harm" principle by which Taxonomy-aligned investments should not significantly harm EU Taxonomy objectives and is accompanied by specific EU criteria.

The "do not significant harm" principle applies only to those investments underlying the financial product that take into account the EU criteria for environmentally sustainable economic activities. The investments underlying the remaining portion of this financial product do not take into account the EU criteria for environmentally sustainable economic activities.

Any other sustainable investments must also not significantly harm any environmental or social objectives.



Does this financial product consider principal adverse impacts on sustainability factors?

Yes

No

The Management Company has joined the Net Zero Asset Manager Initiative and considers PAI indicators through stewardship including engagement, both are relevant to mitigate potential adverse impact as a company.

Due to the commitment to the Net Zero Asset Manager Initiative, the Management Company aims to reduce greenhouse gas emissions in partnership with asset owner clients on decarbonisation goals, consistent with an ambition to reach net zero emission by 2050 or sooner across all assets under management. As part of this objective the Management Company will set an interim target for the proportion of assets to be managed in line with the attainment of net zero emissions by 2050 or sooner.

The Sub-Fund's Investment Manager addresses PAI indicators regarding greenhouse gas emission, biodiversity, water, waste as well as social and employee matters for corporate issuers, and, where relevant, the freedom house index is applied to investments in sovereigns. PAI indicators are considered within the Investment Manager's investment process through the means of exclusions as described in the "binding elements" section of the Sub-Fund.

The data coverage for the data required for the PAI indicators is heterogenous. The data coverage related to biodiversity, water and waste is low and the related PAI indicators are considered through exclusion of securities issued by companies having a severe violation / breach of principles and guidelines such as the Principles of the United Nations Global Compact, the OECD Guidelines for Multinational Enterprises, and the United Nations Guiding Principles for Business and Human Rights on the grounds of problematic practices around human rights, labour rights, environment, and corruption issues. Therefore, the Investment Manager will strive to increase data coverage for PAI indicators with low data coverage. The Investment Manager will regularly evaluate whether the availability of data has increased sufficiently to potentially include assessment of such data in the investment process.

Additionally, the investment Manager considers PAI indicators by limiting its allocation into issuers which significantly harm environmental and/or social objectives.

The following PAI indicators are considered:

Applicable to corporate issuers

- GHG Emissions
- Carbon footprint
- GHG Intensity of investee companies
- Exposure to companies active in the fossil fuel sector
- Activities negatively affecting biodiversity-sensitive areas
- Emissions to water
- Hazardous waste ratio

- Violation of UN Global compact principles
- Lack of processes and compliance mechanisms to monitor compliance with UN Global Compact principles
- Board gender diversity
- Exposure to controversial weapons

Applicable to sovereign and supranational issuers

- Investee countries subject to social violations

The information on the PAI indicators will be available in the end-year report of the Sub-Fund.



What investment strategy does this financial product follow?

The investment strategy guides investment decisions based on factors such as investment objectives and risk tolerance.

Allianz Europe Small Cap Equity's investment objective is to invest in European Equity Markets with a focus on small-sized companies in accordance with the Sustainability Key Performance Indicator Strategy (Absolute Threshold) ("KPI Strategy (Absolute Threshold)"). The Sub-Fund's strategy is to target a specific minimum allocation into Sustainable Investments and limit its allocation to DNSH.

The proportion of assets which do not have a Sustainable Investment share assessment is expected to be low. Examples of instruments not having a Sustainable Investment share assessment are cash and deposits, some Target Funds, and investments for which data is not available.

The Sub-Fund's general investment approach (Sub-Fund's applicable General Asset Class Principles in combination with its individual investment restrictions) is described in the prospectus.

● What are the binding elements of the investment strategy used to select the investments to attain each of the environmental or social characteristics promoted by this financial product?

The investment strategy adheres to the following binding elements to attain the environmental and/ or social characteristics promoted:

- Min. 70% of Sub-Fund's portfolio shall be invested in companies which have been assessed according to the Sustainable Investment methodology (Portfolio in this respect does not comprise derivatives and instruments that are non-evaluated by nature (e. g., cash and deposits)).
- Min. 20% of weighted-average Sustainable Investment share at Sub Fund Assets. If the Investment Manager acquires a use of proceed security, which finance specific projects contributing to environmental or social objectives, the overall investment is considered to contribute to environmental and/or social objectives according to the Sustainable Investment methodology.
- Max. 10% of Sub-Fund assets will be invested in securities from issuers not satisfying the Do No Significant Harm ("DNSH") principles.- Application of the following sustainable minimum exclusion criteria for direct investments:
 - securities issued by companies having a severe violation / breach of principles and guidelines such as the Principles of the United Nations Global Compact, the OECD Guidelines for Multinational Enterprises, and the United Nations Guiding Principles for Business and Human Rights on the grounds of problematic practices around human rights, labour rights, environment, and corruption,
 - securities issued by companies involved in controversial weapons (anti-personnel mines, cluster munitions, chemical weapons, biological weapons, depleted uranium, white phosphorus, and nuclear weapons),
 - securities issued by companies that derive more than 10% of their revenues from weapons, military equipment, and services,
 - securities issued by companies that derive more than 10% of their revenue from thermal coal extraction
 - securities issued by utility companies that generate more than 20% of their revenues from coal,
 - securities issued by companies involved in the production of tobacco, and securities issued by companies involved in the distribution of tobacco with more than 5% of their revenues.

Direct investments in sovereign issuers with an insufficient freedom house index score are excluded.

The sustainable minimum exclusion criteria are based on information from an external data provider and coded in pre- and post-trade compliance. The review is performed at least half yearly.

- **What is the committed minimum rate to reduce the scope of the investments considered prior to the application of that investment strategy?**

The Sub-Fund does not commit to reduce the scope of the investments by a certain minimum rate.

- **What is the policy to assess good governance practices of the investee companies?**

Good governance principles are considered by screening out companies based on their involvement in controversies around international norms corresponding to the four good governance practices: sound management structures, employee relations, remuneration of staff and tax compliance. Companies having a severe violation in either of those areas will not be investible. For certain cases, flagged issuers shall be on a watch list. These companies will appear on this watch list when the Investment Manager believes that engagement may lead to improvements or when the company is assessed to take remedial actions. Companies on the watch list remain investible unless the Investment Manager believes that the engagement or the remedial actions of the company does not lead to the desired remedy of the severe controversy.

In addition, the Sub-Fund's Investment Manager is committed to actively encourage open dialogues with investee companies on corporate governance, proxy voting and broader sustainability issues in advance of shareholder meetings (regularly for direct investments in shares). The Sub-Fund's Investment Manager's approach to proxy voting and company engagement is set out in the Management Company's Stewardship Statement.

Good governance practices include sound management structures, employee relations, remuneration of staff and tax compliance.



What is the asset allocation planned for this financial product?

Asset allocation describes the share of investments in specific assets.

Min. 70% of the Sub-Funds' assets (excluding cash, and derivatives) are used to meet the environmental or social characteristics promoted by this Sub-Fund. A low portion of the Sub-Fund might contain assets which do not promote environmental or social characteristics. Example of such instruments are derivatives, cash and deposits, some Target Funds and investment with temporarily divergent or absent environmental, social, or good governance qualifications. Min. 20% of the Sub-Funds' assets will be invested in Sustainable Investments. The minimum percentage of investments that are aligned with the EU Taxonomy is 0.01%. The Sub-Fund's Investment Manager does not commit to a minimum share of environmentally Sustainable Investments that are not aligned with the EU Taxonomy. The Sub-Fund's Investment Manager does not commit to a minimum share of socially sustainable investments. While the Sub-Fund cannot commit to a minimum share of environmentally or socially sustainable investments, such investments may be freely allocated to within the Sub-Fund aggregated sustainable investment commitment disclosed (min. 20%).

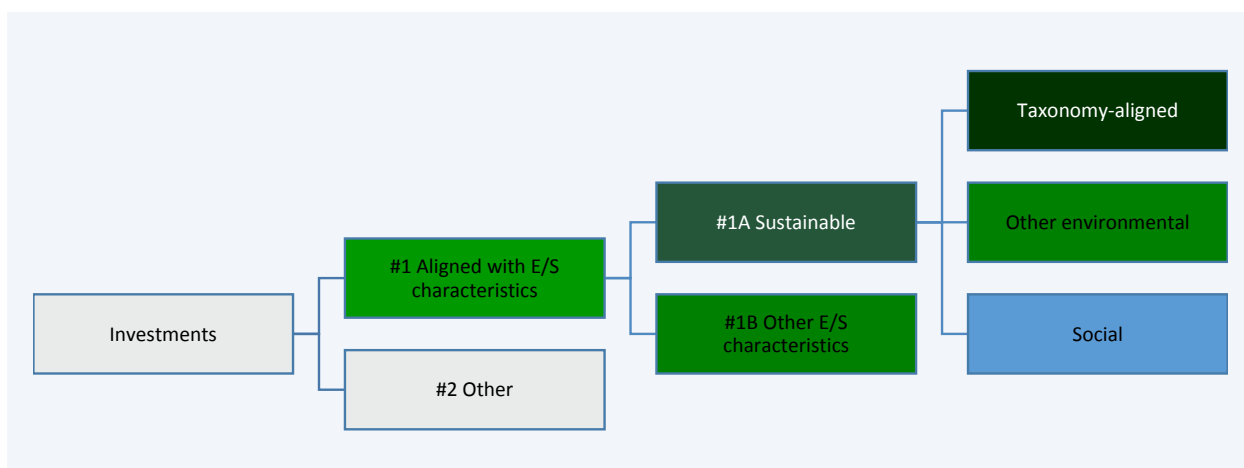

#1 Aligned with E/S characteristics includes the investments of the financial product used to attain the environmental or social characteristics promoted by the financial product.

#2 Other includes the remaining investments of the financial product which are neither aligned with the environmental or social characteristics, nor are qualified as sustainable investments.

The category **#1 Aligned with E/S characteristics** covers:

- The sub-category **#1A Sustainable** covers sustainable investments with environmental or social objectives.
- The sub-category **#1B Other E/S characteristics** covers investments aligned with the environmental or social characteristics that do not qualify as sustainable investments.

- How does the use of derivatives attain the environmental or social characteristics promoted by the financial product?

Not applicable



To what minimum extent are sustainable investments with an environmental objective aligned with the EU Taxonomy?

The Taxonomy-aligned investments include debt and/or equity in environmentally sustainable economic activities aligned with the EU-Taxonomy. The minimum percentage of investments that are aligned with the EU Taxonomy is 0.01%. Taxonomy-aligned data is provided by an external data provider. The Investment Manager has assessed the quality of such data. The data will not be subject to an assurance provided by auditors or a review by third parties. The data will not reflect any data in government bonds. As of today, there is no recognized methodology available to determine the proportion of Taxonomy-aligned activities when investing in government bonds.

Taxonomy-aligned activities in this disclosure are based on share of turnover. Pre-contractual figures use turnover as its financial metric as a default in line with the regulatory requirements and based on the fact that complete, verifiable or up-to date data for CAPEX and/or OPEX as financial metric is even less available.

Taxonomy-aligned data is only in rare cases data reported by companies in accordance with the EU Taxonomy. The data provider has derived Taxonomy-aligned data from other available equivalent public data.

- Does the financial product invest in fossil gas and/or nuclear energy related activities that comply with the EU Taxonomy¹?

Yes:

In fossil gas In nuclear energy

No

The Sub-Fund does not pursue any investments in fossil gas and/or nuclear energy related activities that comply with the EU Taxonomy. Nevertheless, as result of this investment strategy, investments may occur in corporates which are also active in these activities. Further information will be provided as part of the annual reporting, if relevant.

The two graphs below show in green the minimum percentage of investments that are aligned with the EU Taxonomy. As there is no appropriate methodology to determine the Taxonomy-alignment of sovereign bonds*, the first graph shows the Taxonomy-alignment in relation to all the investments of the financial product including sovereign bonds, while the second graph shows the Taxonomy-alignment only in relation to the investments of the financial product other than sovereign bonds.

1. Taxonomy-alignment of investments including sovereign bonds*

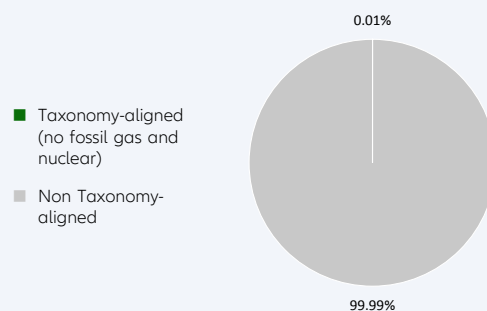

2. Taxonomy-alignment of investments excluding sovereign bonds*

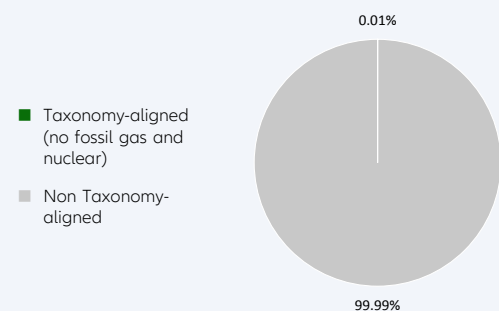

This graph represents X% of the total investments.

It is noted that this Sub-Fund does not provide for a binding minimum quota for investments in sovereign bonds. Therefore, this Sub-Fund may have (but must not have) an exposure to sovereign bonds. In the absence of a binding minimum quota for investments in sovereign

Taxonomy-aligned activities are expressed as a share of:

- **turnover** reflecting the share of revenue from green activities of investee companies
- **capital expenditure (CapEx)** showing the green investments made by investee companies, e.g. for a transition to a green economy.
- **operational expenditure (OpEx)** reflecting green operational activities of investee companies.

¹ Fossil gas and/or nuclear related activities will only comply with the EU Taxonomy where they contribute to limiting climate change ("climate change mitigation") and do not significantly harm any EU Taxonomy objective - see explanatory note in the left hand margin. The full criteria for fossil gas and nuclear energy economic activities that comply with the EU Taxonomy are laid down in Commission Delegated Regulation (EU) 2022/1214.

bonds, this graph does not generate any additional added value compared to the left-hand graph.

* For the purpose of these graphs, 'sovereign bonds' consist of all sovereign exposures

Enabling activities directly enable other activities to make a substantial contribution to an environmental objective.

Transitional activities are activities for which low-carbon alternatives are not yet available and among others have greenhouse gas emission levels corresponding to the best performance.

● **What is the minimum share of investments in transitional and enabling activities?**

The Sub-Fund's Investment Manager does not commit to a split of minimum taxonomy alignment into transitional, enabling activities and own performance.



What is the minimum share of sustainable investments with an environmental objective that are not aligned with the EU Taxonomy?

Taxonomy-aligned investments are considered a sub-category of Sustainable Investments. If an investment is not Taxonomy-aligned since the activity is not yet covered under the EU Taxonomy or the positive contribution is not substantial enough to comply with the Taxonomy technical screening criteria, the investment can still be considered an environmentally Sustainable Investment provided it complies with all criteria. The Investment Manager does not commit to a minimum share of environmentally Sustainable Investments that are not aligned with the EU Taxonomy. The overall sustainable investment share may also include investments with an environmental objective in economic activities that do not qualify as environmentally sustainable under the EU Taxonomy, and while the Sub-Fund cannot commit to a minimum share of environmentally or socially sustainable investments, such investments may be freely allocated to within the Sub-Fund aggregated sustainable investment commitment disclosed (min 20%).



are sustainable investments with an environmental objective that **do not take into account the criteria** for environmentally sustainable economic activities under the EU Taxonomy.



What is the minimum share of socially sustainable investments?

The Investment Manager defines Sustainable Investments based on internal research, which uses, among others, the UN Sustainable Development Goals (SDGs), as well as the objectives of the EU Taxonomy as reference frameworks. The Investment Manager does not commit to a minimum share of socially Sustainable Investments, as the SDGs contain environmental as well as social objectives. The overall sustainable investment share may also include investments with a social objective, and while the Sub-Fund cannot commit to a minimum share of environmentally or socially sustainable investments, such investments may be freely allocated to within the Sub-Fund aggregated sustainable investment commitment disclosed (min 20%).



What investments are included under “#2 Other”, what is their purpose and are there any minimum environmental or social safeguards?

Under “#2 Other” investments into cash, Target Funds, or derivatives can be included. Derivatives might be used for efficient portfolio management (including risk hedging) and/or investment purposes, and Target Funds to benefit from a specific strategy. For those investments no environmental or social safeguards are applied.



Is a specific index designated as a reference benchmark to determine whether this financial product is aligned with the environmental and/or social characteristics that it promotes?

No reference benchmark has been designated for the purpose of attaining the environmental and/or social characteristics promoted by the Sub-Fund.

Reference benchmarks are indexes to measure whether the financial product attains the environmental or social characteristics that they promote.

- **How is the reference benchmark continuously aligned with each of the environmental or social characteristics promoted by the financial product?**
Not applicable
- **How is the alignment of the investment strategy with the methodology of the index ensured on a continuous basis?**
Not applicable
- **How does the designated index differ from a relevant broad market index?**
Not applicable
- **Where can the methodology used for the calculation of the designated index be found?**
Not applicable



Where can I find more product specific information online?

More product-specific information can be found on the website: <https://regulatory.allianzgi.com/SFDR>

Template pre-contractual disclosure for the financial products referred to in Article 8, paragraphs 1, 2 and 2a, of Regulation (EU) 2019/2088 and Article 6, first paragraph, of Regulation (EU) 2020/852

Product name:

Allianz European Equity Dividend

Legal entity identifier: 549300XUMQIJXEX2O502

Environmental and/or social characteristics

Sustainable investment means an investment in an economic activity that contributes to an environmental or social objective, provided that the investment does not significantly harm any environmental or social objective and that the investee companies follow good governance practices.

The EU Taxonomy is a classification system laid down in Regulation (EU) 2020/852, establishing a list of environmentally sustainable economic activities. That Regulation does not include a list of socially sustainable economic activities. Sustainable investments with an environmental objective might be aligned with the Taxonomy or not.

Does this financial product have a sustainable investment objective?	
Yes	No
<input type="checkbox"/> It will make a minimum of sustainable investments with an environmental objective: ___% <input type="checkbox"/> in economic activities that qualify as environmentally sustainable under the EU Taxonomy <input type="checkbox"/> in economic activities that do not qualify as environmentally sustainable under the EU Taxonomy	<input checked="" type="checkbox"/> It promotes Environmental/Social (E/S) characteristics and while it does not have as its objective a sustainable investment, it will have a minimum proportion of 10.00% of sustainable investments <input checked="" type="checkbox"/> with an environmental objective in economic activities that qualify as environmentally sustainable under the EU Taxonomy <input checked="" type="checkbox"/> with an environmental objective in economic activities that do not qualify as environmentally sustainable under the EU Taxonomy <input checked="" type="checkbox"/> with a social objective
<input type="checkbox"/> It will make a minimum of sustainable investments with a social objective ___%	<input type="checkbox"/> It promotes E/S characteristics, but will not make any sustainable investments



What environmental and/or social characteristics are promoted by this financial product?

Allianz European Equity Dividend (the "Sub-Fund") is managed according to the Sustainability Key Performance Indicator Strategy (Absolute) ("KPI Strategy (Absolute)") which addresses greenhouse gas (GHG) Intensity. The "Sustainability KPI" measures the GHG Intensity defined by the weighted average intensity of greenhouse gas emissions based on a company's annual sales ("GHG Intensity").

GHG Intensity will be addressed by ensuring a year-on-year improvement pathway of the weighted average GHG Intensity on portfolio level for the prospective fiscal year ends of the Sub-Fund.

In addition, sustainable minimum exclusion criteria apply.

No reference benchmark has been designated for the purpose of attaining the environmental and/or social characteristics promoted by the Sub-Fund.

● What sustainability indicators are used to measure the attainment of each of the environmental or social characteristics promoted by this financial product?

To measure the attainment of the environmental and/or social characteristics the following sustainability indicators are used and reported on, at the fiscal year end:

- The actual percentage of KPI coverage of the Sub-Fund's Portfolio (Portfolio in this respect does not comprise derivatives and instruments that are non-evaluated by nature (e. g., cash and deposits)).
- The year-on-year improvement pathway of the Sub-Fund's Weighted Average GHG Intensity.

Sustainability indicators measure how the environmental or social characteristics promoted by the financial product are attained.

- Confirmation that Principal Adverse Impacts (PAIs) of investment decisions on sustainability factors are considered through the application of exclusion criteria.

- **What are the objectives of the sustainable investments that the financial product partially intends to make and how does the sustainable investment contribute to such objectives?**

Sustainable investments contribute to environmental and/or social objectives, for which the Investment Manager uses as reference frameworks, among others, the UN Sustainable Development Goals (SDGs), as well as the objectives of the EU Taxonomy:

1. Climate Change Mitigation
2. Climate Change Adaptation
3. Sustainable Use and Protection of Water and Marine Resources
4. Transition to a Circular Economy
5. Pollution Prevention and Control
6. Protection and Restoration of Biodiversity and Ecosystems

The assessment of the positive contribution to the environmental or social objectives is based on a proprietary framework which combines quantitative elements with qualitative inputs from internal research. The methodology applies first a quantitative breakdown of a securities issuer into its business activities. The qualitative element of the framework is an assessment if business activities contribute positively to an environmental or a social objective.

To calculate the positive contribution on the Sub-Fund level the revenue share of each issuer attributable to business activities contributing to environmental and/or social objectives is considered provided the issuer is satisfying the Do No Significant Harm ("DNSH") and Good Governance principles, and an asset-weighted aggregation is performed as a second step. Moreover, for certain types of securities, which finance specific projects contributing to environmental or social objectives the overall investment is considered to contribute to environmental and/or social objectives, but also for these a DNSH as well as a Good Governance check for issuers is performed.

- **How do the sustainable investments that the financial product partially intends to make, not cause significant harm to any environmental or social sustainable investment objective?**

In order to ensure that Sustainable Investments do not significantly harm any other environmental and/or social objective, the Investment Manager is leveraging the PAI indicators, whereby significance thresholds have been defined to identify significantly harmful issuers. Issuers not meeting the significance threshold can be engaged for a limited time period to remediate the adverse impact. Otherwise, if the issuer does not meet the defined significance thresholds twice subsequently or in case of a failed engagement, it does not pass the DNSH assessment. Investments in securities of issuers which do not pass the DNSH assessment are not counted as sustainable investments.

- *How have the indicators for adverse impacts on sustainability factors been taken into account?*

All mandatory PAI indicators are considered either as part of the application of the exclusion criteria or through thresholds on a sectorial or absolute basis. Significance thresholds have been defined and they refer to qualitative or quantitative criteria.

Recognizing the lack of data coverage for some of the PAI indicators equivalent data points are used to assess PAI indicators when applying the DNSH assessment, when relevant, for the following indicators for corporates: share of non-renewable energy consumption and production, activities negatively affecting biodiversity-sensitive areas, emissions to water, lack of processes and compliance mechanisms to monitor compliance with UNGC principles and OECD Guidelines for Multinational Enterprises; for sovereigns: GHG Intensity and investee countries subject to social violations. In case of securities which finance specific projects contributing to environmental or social objectives equivalent data at project level might be used to ensure that Sustainable Investments do not significantly harm any other environmental and/or social objective. The Investment Manager will strive to increase data coverage for PAI indicators with low data coverage by engaging with issuers and data providers. The Investment Manager will regularly evaluate whether the availability of data has increased sufficiently to potentially include assessment of such data in the investment process.

Principal adverse impacts are the most significant negative impacts of investment decisions on sustainability factors relating to environmental, social and employee matters, respect for human rights, anti-corruption and anti-bribery matters.

- *How are the sustainable investments aligned with the OECD Guidelines for Multinational Enterprises and the UN Guiding Principles on Business and Human Rights? Details:*

The Investment Manager's sustainable minimum exclusion list screens out companies based on their involvement in controversial practices against international norms. The core normative framework consists of the Principles of the UN Global Compact, the OECD Guidelines for Multinational Enterprises and the UN Guiding Principles for Business and Human Rights. Securities issued by companies having a severe violation of these frameworks will be restricted from the investment universe.

The EU Taxonomy sets out a "do not significant harm" principle by which Taxonomy-aligned investments should not significantly harm EU Taxonomy objectives and is accompanied by specific EU criteria.

The "do not significant harm" principle applies only to those investments underlying the financial product that take into account the EU criteria for environmentally sustainable economic activities. The investments underlying the remaining portion of this financial product do not take into account the EU criteria for environmentally sustainable economic activities.

Any other sustainable investments must also not significantly harm any environmental or social objectives.



Does this financial product consider principal adverse impacts on sustainability factors?

Yes

No

The Management Company has joined the Net Zero Asset Manager Initiative and considers PAI indicators through stewardship including engagement, both are relevant to mitigate potential adverse impact as a company.

Due to the commitment to the Net Zero Asset Manager Initiative, the Management Company aims to reduce greenhouse gas emissions in partnership with asset owner clients on decarbonisation goals, consistent with an ambition to reach net zero emission by 2050 or sooner across all assets under management. As part of this objective the Management Company will set an interim target for the proportion of assets to be managed in line with the attainment of net zero emissions by 2050 or sooner.

The Sub-Fund's Investment Manager addresses PAI indicators regarding greenhouse gas emission, biodiversity, water, waste as well as social and employee matters for corporate issuers, and, where relevant, the freedom house index is applied to investments in sovereigns. PAI indicators are considered within the Investment Manager's investment process through the means of exclusions as described in the "binding elements" section of the Sub-Fund.

The data coverage for the data required for the PAI indicators is heterogenous. The data coverage related to biodiversity, water and waste is low and the related PAI indicators are considered through exclusion of securities issued by companies having a severe violation / breach of principles and guidelines such as the Principles of the United Nations Global Compact, the OECD Guidelines for Multinational Enterprises, and the United Nations Guiding Principles for Business and Human Rights on the grounds of problematic practices around human rights, labour rights, environment, and corruption issues. Therefore, the Investment Manager will strive to increase data coverage for PAI indicators with low data coverage. The Investment Manager will regularly evaluate whether the availability of data has increased sufficiently to potentially include assessment of such data in the investment process.

Additionally, the Investment manager considers GHG related PAI indicators by ensuring a Weighted Average GHG Intensity improvement pathway. The following PAI indicators are considered:

Applicable to corporate issuers

- GHG Emissions
- Carbon footprint
- GHG Intensity of investee companies
- Exposure to companies active in the fossil fuel sector
- Activities negatively affecting biodiversity-sensitive areas
- Emissions to water
- Hazardous waste ratio
- Violation of UN Global compact principles

- Lack of processes and compliance mechanisms to monitor compliance with UN Global Compact principles
- Board gender diversity
- Exposure to controversial weapons

Applicable to sovereign and supranational issuers

- Investee countries subject to social violations

The information on the PAI indicators will be available in the end-year report of the Sub-Fund.



What investment strategy does this financial product follow?

The investment strategy guides investment decisions based on factors such as investment objectives and risk tolerance.

Allianz European Equity Dividend's investment objective is to invest in companies of European Equity Markets that are expected to achieve sustainable dividend returns in accordance with the Sustainability Key Performance Indicator Strategy (Absolute) ("KPI Strategy (Absolute)").

The Sub-Fund's strategy is to achieve, at least, a year-on-year improvement pathway on the Sub-Fund's weighted average Sustainability KPI. The Sustainability KPI measures the GHG Intensity defined by the weighted average intensity of greenhouse gas emissions based on a company's annual sales ("GHG Intensity"). In order to reach this target, the Investment Manager will proceed to yearly checks, comparing the Sub-Fund's Sustainability KPI to the annual improvement pathway (time series) of the Sustainability KPI. The time series will be established at the first day of application of the Sustainability KPI (reference date) using the target annual improvement rate for the prospective fiscal year ends of the Sub-Fund. For each fiscal year end of the time series, the annual improvement rate will be applied to the value of the previous fiscal year end target. For the period between Reference Point and the first fiscal year end a pro rata temporis rate of the annual rate will be applied.

The weighted average GHG Intensity is the weighted average of the Sub-Fund's GHG Intensity (in tCO₂e per Millions of sales). Sales represent company's annual sales. This ratio of GHG normalized by Sales facilitates comparison between companies of different sizes. The metric allows comparing weighted average GHG Intensities of different portfolios to identify portfolios comprised of more GHG-efficient issuers in terms of the issuer's sales. The portfolio weights (and benchmark or universe weights) are rebased such that only issuers with GHG emissions data available are considered in the calculation. GHG represents a respective issuer's greenhouse gas emissions. To determine the GHG Intensity of a company issuer, GHG Intensity data from third party data providers will be used. The GHG intensity is analysed by the Investment Manager and is considered within the securities selection process in order to meet the Sub-Fund Investment objective.

The proportion of assets which do not have a GHG intensity assessment is expected to be low. Examples of instruments not having a GHG intensity assessment are cash and deposits, some Target Funds, and investments for which the GHG intensity is deemed to be not appropriate and/or data is not available.

The Sub-Fund's general investment approach (Sub-Fund's applicable General Asset Class Principles in combination with its individual investment restrictions) is described in the prospectus.

● What are the binding elements of the investment strategy used to select the investments to attain each of the environmental or social characteristics promoted by this financial product?

The binding elements are:

- Min. 80% KPI coverage of the Sub-Fund's Portfolio (Portfolio in this respect does not comprise derivatives and instruments that are non-evaluated by nature (e. g., cash and deposits)).
- At least a 5% year-on-year improvement pathway of the Sub-Fund's Weighted Average GHG Intensity starting at the reference date December 29, 2022. For the period between Reference Point and the first fiscal year end a pro rata temporis rate of the annual rate will be applied.
- Application of the following sustainable minimum exclusion criteria for direct investments:
 - securities issued by companies having a severe violation / breach of principles and guidelines such as the Principles of the United Nations Global Compact, the OECD Guidelines for Multinational Enterprises, and the United Nations Guiding Principles for Business and Human Rights on the grounds of problematic practices around human rights, labour rights, environment, and corruption issues,
 - securities issued by companies involved in controversial weapons (anti-personnel mines, cluster munitions, chemical weapons, biological weapons, depleted uranium, white phosphorus, and nuclear weapons),

- securities issued by companies that derive more than 10% of their revenues from weapons, military equipment, and services,
- securities issued by companies that derive more than 10% of their revenue from thermal coal extraction,
- securities issued by utility companies that generate more than 20% of their revenues from coal,
- securities issued by companies involved in the production of tobacco, and securities issued by companies involved in the distribution of tobacco with more than 5% of their revenues.

Direct investments in sovereign issuers with an insufficient freedom house index score are excluded

The sustainable minimum exclusion criteria are based on information from an external data provider and coded in pre- and post-trade compliance. The review is performed at least half yearly.

● **What is the committed minimum rate to reduce the scope of the investments considered prior to the application of that investment strategy?**

The Sub-Fund does not commit to reduce the scope of the investments by a certain minimum rate.

● **What is the policy to assess good governance practices of the investee companies?**

Good governance principles are considered by screening out companies based on their involvement in controversies around international norms corresponding to the four good governance practices: sound management structures, employee relations, remuneration of staff and tax compliance. Companies having a severe violation in either of those areas will not be investible. For certain cases, flagged issuers shall be on a watch list. These companies will appear on this watch list when the Investment Manager believes that engagement may lead to improvements or when the company is assessed to take remedial actions. Companies on the watch list remain investible unless the Investment Manager believes that the engagement or the remedial actions of the company does not lead to the desired remedy of the severe controversy.

In addition, the Sub-Fund's Investment Manager is committed to actively encourage open dialogues with investee companies on corporate governance, proxy voting and broader sustainability issues in advance of shareholder meetings (regularly for direct investments in shares). The Sub-Fund's Investment Manager's approach to proxy voting and company engagement is set out in the Management Company's Stewardship Statement.

Good governance practices include sound management structures, employee relations, remuneration of staff and tax compliance.



What is the asset allocation planned for this financial product?

Asset allocation describes the share of investments in specific assets.

Min. 80% of the Sub-Funds' assets (excluding cash, and derivatives) are used to meet the environmental or social characteristics promoted by this Sub-Fund. A low portion of the Sub-Fund might contain assets which do not promote environmental or social characteristics. Examples of such instruments are derivatives, cash and deposits, some Target Funds and investment with temporarily divergent or absent environmental, social, or good governance qualifications. Min. 10% of the Sub-Funds' assets will be invested in Sustainable Investments. The minimum percentage of investments that are aligned with the EU Taxonomy is 0.01%. The Sub-Fund's Investment Manager does not commit to a minimum share of environmentally Sustainable Investments that are not aligned with the EU Taxonomy. The Sub-Fund's Investment Manager does not commit to a minimum share of socially sustainable investments. While the Sub-Fund cannot commit to a minimum share of environmentally or socially sustainable investments, such investments may be freely allocated to within the Sub-Fund aggregated sustainable investment commitment disclosed (min 10%).

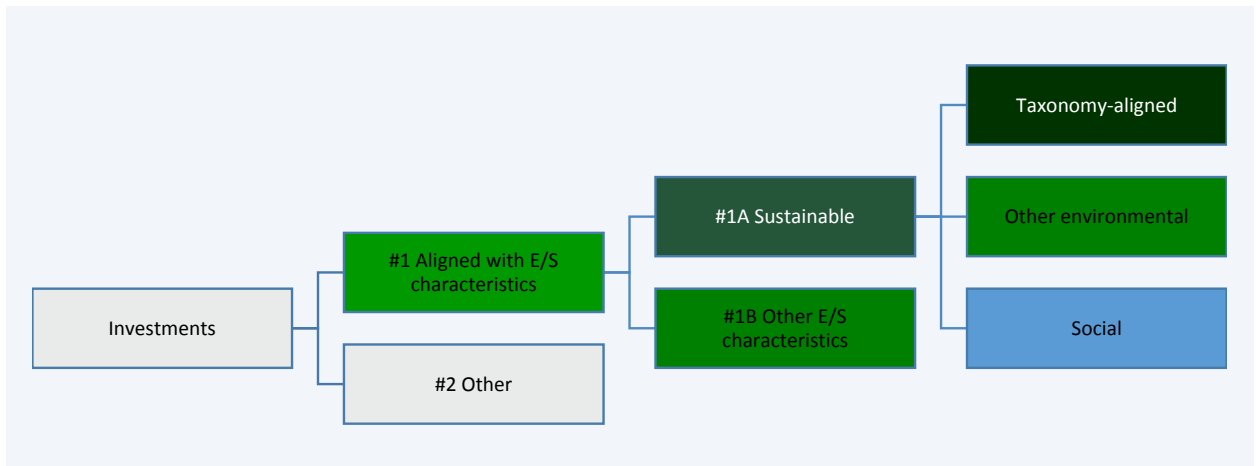

#1 Aligned with E/S characteristics includes the investments of the financial product used to attain the environmental or social characteristics promoted by the financial product.

#2 Other includes the remaining investments of the financial product which are neither aligned with the environmental or social characteristics, nor are qualified as sustainable investments.

The category **#1 Aligned with E/S characteristics** covers:

- The sub-category **#1A Sustainable** covers sustainable investments with environmental or social objectives.
- The sub-category **#1B Other E/S characteristics** covers investments aligned with the environmental or social characteristics that do not qualify as sustainable investments.

- **How does the use of derivatives attain the environmental or social characteristics promoted by the financial product?**

Not applicable



To what minimum extent are sustainable investments with an environmental objective aligned with the EU Taxonomy?

The Taxonomy-aligned investments include debt and/or equity in environmentally sustainable economic activities aligned with the EU-Taxonomy. The minimum percentage of investments that are aligned with the EU Taxonomy is 0.01%. Taxonomy-aligned data is provided by an external data provider. The Investment Manager has assessed the quality of such data. The data will not be subject to an assurance provided by auditors or a review by third parties. The data will not reflect any data in government bonds. As of today, there is no recognized methodology available to determine the proportion of Taxonomy-aligned activities when investing in government bonds.

Taxonomy-aligned activities in this disclosure are based on share of turnover. Pre-contractual figures use turnover as its financial metric as a default in line with the regulatory requirements and based on the fact that complete, verifiable or up-to date data for CAPEX and/or OPEX as financial metric is even less available.

Taxonomy-aligned data is only in rare cases data reported by companies in accordance with the EU Taxonomy. The data provider has derived Taxonomy-aligned data from other available equivalent public data.

- **Does the financial product invest in fossil gas and/or nuclear energy related activities that comply with the EU Taxonomy ¹?**

Yes:

In fossil gas In nuclear energy

No

The Sub-Fund does not pursue any investments in fossil gas and/or nuclear energy related activities that comply with the EU Taxonomy. Nevertheless, as result of this investment strategy, investments may occur in corporates which are also active in these activities. Further information will be provided as part of the annual reporting, if relevant.

Taxonomy-aligned activities are expressed as a share of:

- **turnover** reflecting the share of revenue from green activities of investee companies
- **capital expenditure (CapEx)** showing the green investments made by investee companies, e.g. for a transition to a green

¹ Fossil gas and/or nuclear related activities will only comply with the EU Taxonomy where they contribute to limiting climate change ("climate change mitigation") and do not significantly harm any EU Taxonomy objective - see explanatory note in the left hand margin. The full criteria for fossil gas and nuclear energy economic activities that comply with the EU Taxonomy are laid down in Commission Delegated Regulation (EU) 2022/1214.

economy.
- **operational expenditure** (OpEx) reflecting green operational activities of investee companies.

The two graphs below show in green the minimum percentage of investments that are aligned with the EU Taxonomy. As there is no appropriate methodology to determine the Taxonomy-alignment of sovereign bonds*, the first graph shows the Taxonomy-alignment in relation to all the investments of the financial product including sovereign bonds, while the second graph shows the Taxonomy-alignment only in relation to the investments of the financial product other than sovereign bonds.

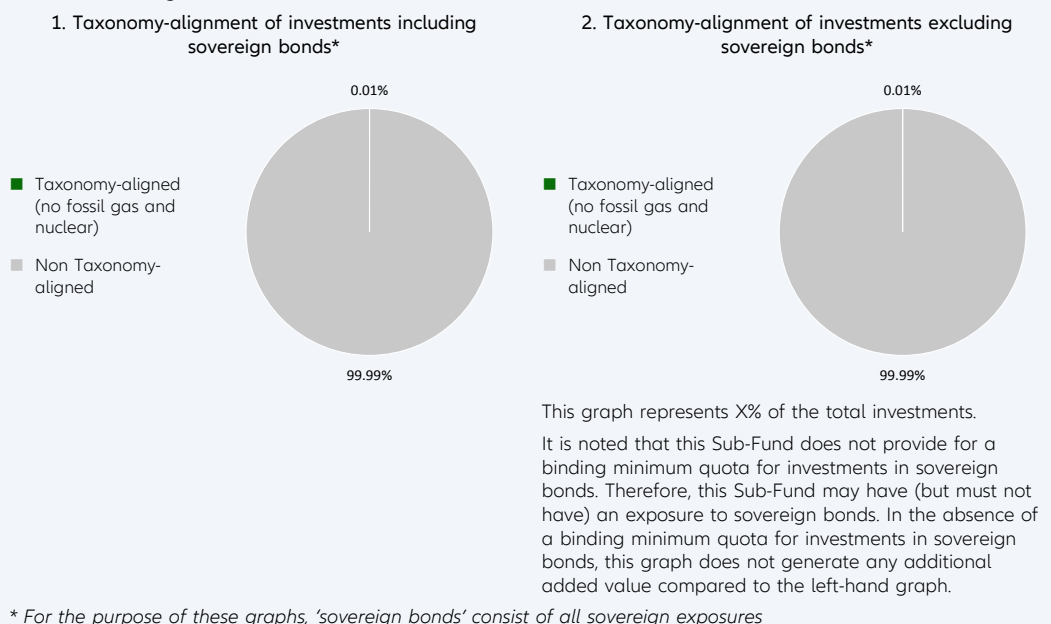

Enabling activities directly enable other activities to make a substantial contribution to an environmental objective.

● **What is the minimum share of investments in transitional and enabling activities?**

The Sub-Fund's Investment Manager does not commit to a split of minimum taxonomy alignment into transitional, enabling activities and own performance.

Transitional activities are activities for which low-carbon alternatives are not yet available and among others have greenhouse gas emission levels corresponding to the best performance.



What is the minimum share of sustainable investments with an environmental objective that are not aligned with the EU Taxonomy?

Taxonomy-aligned investments are considered a sub-category of Sustainable Investments. If an investment is not Taxonomy-aligned since the activity is not yet covered under the EU Taxonomy or the positive contribution is not substantial enough to comply with the Taxonomy technical screening criteria, the investment can still be considered an environmentally Sustainable Investment provided it complies with all criteria. The Investment Manager does not commit to a minimum share of environmentally Sustainable Investments that are not aligned with the EU Taxonomy. The overall sustainable investment share may also include investments with an environmental objective in economic activities that do not qualify as environmentally sustainable under the EU Taxonomy, and while the Sub-Fund cannot commit to a minimum share of environmentally or socially sustainable investments, such investments may be freely allocated to within the Sub-Fund aggregated sustainable investment commitment disclosed (min 10%).

are sustainable investments with an environmental objective that **do not take into account the criteria** for environmentally sustainable economic activities under the EU Taxonomy.



What is the minimum share of socially sustainable investments?

The Investment Manager defines Sustainable Investments based on internal research, which uses, among others, the UN Sustainable Development Goals (SDGs), as well as the objectives of the EU Taxonomy as reference frameworks. The Investment Manager does not commit to a minimum share of socially Sustainable Investments, as the SDGs contain environmental as well as social objectives. The overall sustainable investment share may also include investments with a social objective, and while the Sub-Fund cannot commit to a minimum share of environmentally or socially sustainable investments, such investments may be freely allocated to within the Sub-Fund aggregated sustainable investment commitment disclosed (min 10%).



What investments are included under “#2 Other”, what is their purpose and are there any minimum environmental or social safeguards?

Under “#2 Other” investments into cash, Target Funds, or derivatives can be included. Derivatives might be used for efficient portfolio management (including risk hedging) and/or investment purposes, and Target Funds to benefit from a specific strategy. For those investments no environmental or social safeguards are applied.



Is a specific index designated as a reference benchmark to determine whether this financial product is aligned with the environmental and/or social characteristics that it promotes?

No reference benchmark has been designated for the purpose of attaining the environmental and/or social characteristics promoted by the Sub-Fund.

- How is the reference benchmark continuously aligned with each of the environmental or social characteristics promoted by the financial product?

Not applicable

- How is the alignment of the investment strategy with the methodology of the index ensured on a continuous basis?

Not applicable

- How does the designated index differ from a relevant broad market index?

Not applicable

- Where can the methodology used for the calculation of the designated index be found?

Not applicable

Reference benchmarks are indexes to measure whether the financial product attains the environmental or social characteristics that they promote.



Where can I find more product specific information online?

More product-specific information can be found on the website: <https://regulatory.allianzgi.com/SFDR>

Template pre-contractual disclosure for the financial products referred to in Article 8, paragraphs 1, 2 and 2a, of Regulation (EU) 2019/2088 and Article 6, first paragraph, of Regulation (EU) 2020/852

Product name:

Allianz Flexi Asia Bond

Legal entity identifier: 549300C83822MBOOH659

Environmental and/or social characteristics

Sustainable investment means an investment in an economic activity that contributes to an environmental or social objective, provided that the investment does not significantly harm any environmental or social objective and that the investee companies follow good governance practices.

The **EU Taxonomy** is a classification system laid down in Regulation (EU) 2020/852, establishing a list of **environmentally sustainable economic activities**. That Regulation does not include a list of socially sustainable economic activities. Sustainable investments with an environmental objective might be aligned with the Taxonomy or not.

Does this financial product have a sustainable investment objective?	
Yes	No
<input type="checkbox"/> It will make a minimum of sustainable investments with an environmental objective : ___% <input type="checkbox"/> in economic activities that qualify as environmentally sustainable under the EU Taxonomy <input type="checkbox"/> in economic activities that do not qualify as environmentally sustainable under the EU Taxonomy	<input checked="" type="checkbox"/> It promotes Environmental/Social (E/S) characteristics and while it does not have as its objective a sustainable investment, it will have a minimum proportion of 2.50% of sustainable investments <input checked="" type="checkbox"/> with an environmental objective in economic activities that qualify as environmentally sustainable under the EU Taxonomy <input checked="" type="checkbox"/> with an environmental objective in economic activities that do not qualify as environmentally sustainable under the EU Taxonomy <input checked="" type="checkbox"/> with a social objective
<input type="checkbox"/> It will make a minimum of sustainable investments with a social objective ___%	<input type="checkbox"/> It promotes E/S characteristics, but will not make any sustainable investments



What environmental and/or social characteristics are promoted by this financial product?

Allianz Flexi Asia Bond (the "Sub-Fund") is managed according to the Sustainability Key Performance Indicator Strategy (Relative) ("KPI Strategy (Relative)") which addresses greenhouse gas (GHG) Intensity. The "Sustainability KPI" measures the GHG Intensity defined by the weighted average intensity of greenhouse gas emissions based on company's annual sales ("GHG Intensity").

GHG Intensity will be addressed by outperforming the Weighted Average GHG Intensity against its benchmark.

In addition, sustainable minimum exclusion criteria apply.

A reference benchmark has been designated for the purpose of attaining the environmental and/or social characteristics promoted by the Sub-Fund.

● What sustainability indicators are used to measure the attainment of each of the environmental or social characteristics promoted by this financial product?

To measure the attainment of the environmental and/or social characteristics the following sustainability indicators are used and reported on, at the fiscal year end:

- The actual percentage of KPI coverage of the Sub-Fund's Portfolio (Portfolio in this respect does not comprise derivatives and instruments that are non-evaluated by nature (e. g., cash and deposits)).
- The actual weighted average GHG Intensity portfolio vs weighted average GHG Intensity of the benchmark.

Sustainability indicators measure how the environmental or social characteristics promoted by the financial product are attained.

- Confirmation that Principal adverse impacts (PAIs) of investment decisions on sustainability factors are considered through the application of exclusion criteria.
- **What are the objectives of the sustainable investments that the financial product partially intends to make and how does the sustainable investment contribute to such objectives?**

Sustainable investments contribute to environmental and/or social objectives, for which the Investment Manager uses as reference frameworks, among others, the UN Sustainable Development Goals (SDGs), as well as the objectives of the EU Taxonomy:

1. Climate Change Mitigation
2. Climate Change Adaptation
3. Sustainable Use and Protection of Water and Marine Resources
4. Transition to a Circular Economy
5. Pollution Prevention and Control
6. Protection and Restoration of Biodiversity and Ecosystems

The assessment of the positive contribution to the environmental or social objectives is based on a proprietary framework which combines quantitative elements with qualitative inputs from internal research. The methodology applies first a quantitative breakdown of a securities issuer into its business activities. The qualitative element of the framework is an assessment if business activities contribute positively to an environmental or a social objective.

To calculate the positive contribution on the Sub-Fund level the revenue share of each issuer attributable to business activities contributing to environmental and/or social objectives is considered provided the issuer is satisfying the Do No Significant Harm (“DNSH”) and Good Governance principles, and an asset-weighted aggregation is performed as a second step. Moreover, for certain types of securities, which finance specific projects contributing to environmental or social objectives the overall investment is considered to contribute to environmental and/or social objectives, but also for these a DNSH as well as a Good Governance check for issuers is performed.

- **How do the sustainable investments that the financial product partially intends to make, not cause significant harm to any environmental or social sustainable investment objective?**

In order to ensure that Sustainable Investments do not significantly harm any other environmental and/or social objective, the Investment Manager is leveraging the PAI indicators, whereby significance thresholds have been defined to identify significantly harmful issuers. Issuers not meeting the significance threshold can be engaged for a limited time period to remediate the adverse impact. Otherwise, if the issuer does not meet the defined significance thresholds twice subsequently or in case of a failed engagement, it does not pass the DNSH assessment. Investments in securities of issuers which do not pass the DNSH assessment are not counted as sustainable investments.

- *How have the indicators for adverse impacts on sustainability factors been taken into account?*

All mandatory PAI indicators are considered either as part of the application of the exclusion criteria or through thresholds on a sectorial or absolute basis. Significance thresholds have been defined and they refer to qualitative or quantitative criteria.

Recognizing the lack of data coverage for some of the PAI indicators equivalent data points are used to assess PAI indicators when applying the DNSH assessment, when relevant, for the following indicators for corporates: share of non-renewable energy consumption and production, activities negatively affecting biodiversity-sensitive areas, emissions to water, lack of processes and compliance mechanisms to monitor compliance with UNGC principles and OECD Guidelines for Multinational Enterprises; for sovereigns: GHG Intensity and investee countries subject to social violations. In case of securities which finance specific projects contributing to environmental or social objectives equivalent data at project level might be used to ensure that Sustainable Investments do not significantly harm any other environmental and/or social objective. The Investment Manager will strive to increase data coverage for PAI indicators with low data coverage by engaging with issuers and data providers. The Investment Manager will regularly evaluate whether the availability of data has increased sufficiently to potentially include assessment of such data in the investment process.

Principal adverse impacts are the most significant negative impacts of investment decisions on sustainability factors relating to environmental, social and employee matters, respect for human rights, anti-corruption and anti-bribery matters.

- *How are the sustainable investments aligned with the OECD Guidelines for Multinational Enterprises and the UN Guiding Principles on Business and Human Rights? Details:*

The Investment Manager's sustainable minimum exclusion list screens out companies based on their involvement in controversial practices against international norms. The core normative framework consists of the Principles of the UN Global Compact, the OECD Guidelines for Multinational Enterprises and the UN Guiding Principles for Business and Human Rights. Securities issued by companies having a severe violation of these frameworks will be restricted from the investment universe.

The EU Taxonomy sets out a "do not significant harm" principle by which Taxonomy-aligned investments should not significantly harm EU Taxonomy objectives and is accompanied by specific EU criteria.

The "do not significant harm" principle applies only to those investments underlying the financial product that take into account the EU criteria for environmentally sustainable economic activities. The investments underlying the remaining portion of this financial product do not take into account the EU criteria for environmentally sustainable economic activities.

Any other sustainable investments must also not significantly harm any environmental or social objectives.



Does this financial product consider principal adverse impacts on sustainability factors?

Yes

No

The Management Company has joined the Net Zero Asset Manager Initiative and considers PAI indicators through stewardship including engagement, both are relevant to mitigate potential adverse impact as a company.

Due to the commitment to the Net Zero Asset Manager Initiative, the Management Company aims to reduce greenhouse gas emissions in partnership with asset owner clients on decarbonisation goals, consistent with an ambition to reach net zero emission by 2050 or sooner across all assets under management. As part of this objective the Management Company will set an interim target for the proportion of assets to be managed in line with the attainment of net zero emissions by 2050 or sooner.

The Sub-Fund's Investment Manager addresses PAI indicators regarding greenhouse gas emission, biodiversity, water, waste as well as social and employee matters for corporate issuers, and, where relevant, the freedom house index is applied to investments in sovereigns. PAI indicators are considered within the Investment Manager's investment process through the means of exclusions as described in the "binding elements" section of the Sub-Fund.

The data coverage for the data required for the PAI indicators is heterogenous. The data coverage related to biodiversity, water and waste is low and the related PAI indicators are considered through exclusion of securities issued by companies having a severe violation / breach of principles and guidelines such as the Principles of the United Nations Global Compact, the OECD Guidelines for Multinational Enterprises, and the United Nations Guiding Principles for Business and Human Rights on the grounds of problematic practices around human rights, labour rights, environment, and corruption issues. Therefore, the Investment Manager will strive to increase data coverage for PAI indicators with low data coverage. The Investment Manager will regularly evaluate whether the availability of data has increased sufficiently to potentially include assessment of such data in the investment process.

Additionally, the Investment manager considers GHG related PAI indicators by outperforming the Weighted Average GHG Intensity against its benchmark. The following PAI indicators are considered:

Applicable to corporate issuers

- GHG Emissions
- Carbon footprint
- GHG Intensity of investee companies
- Exposure to companies active in the fossil fuel sector
- Activities negatively affecting biodiversity-sensitive areas
- Emissions to water
- Hazardous waste ratio
- Violation of UN Global compact principles

- Lack of processes and compliance mechanisms to monitor compliance with UN Global Compact principles
- Board gender diversity
- Exposure to controversial weapons

Applicable to sovereign and supranational issuers

- Investee countries subject to social violations

The information on the PAI indicators will be available in the end-year report of the Sub-Fund.



What investment strategy does this financial product follow?

The investment strategy guides investment decisions based on factors such as investment objectives and risk tolerance.

Allianz Flexi Asia Bond's investment objective is to invest in Debt Securities of Asian bond markets denominated in EUR, USD, GBP, JPY, AUD, NZD or any Asian currency in accordance with the Sustainability Key Performance Indicator Strategy (Relative) ("KPI Strategy (Relative)"). The Sub-Fund's strategy is to outperform the Weighted Average GHG Intensity against its benchmark. The outperformance is determined as the excess between the Sub-Fund's weighted average GHG Intensity and the Sub-Fund's benchmark Weighted Average GHG Intensity.

The weighted average GHG Intensity is the weighted average of the Sub-Fund's GHG Intensity (in tCO₂e per Millions of sales). Sales represent company's annual sales. This ratio of GHG normalized by Sales facilitates comparison between companies of different sizes. The ratio is in tCO₂e per Millions of sales. The metric allows comparing weighted average GHG Intensities of different portfolios to identify portfolios comprised of more GHG-efficient issuers in terms of the issuer's sales. The portfolio weights (and benchmark or universe weights) are rebased such that only issuers with GHG emissions data available are considered in the calculation. GHG represents a respective issuer's greenhouse gas emissions. To determine the GHG Intensity of a company issuer, GHG Intensity data from third party data providers will be used. The GHG intensity is analysed by the Investment Manager and is considered within the securities selection process in order to meet the Sub-Fund Investment objective.

The proportion of assets which do not have a GHG intensity assessment is expected to be low. Examples of instruments not having a GHG intensity assessment are cash and deposits, some Target Funds, and investments for which the GHG intensity is deemed to be not appropriate and/or data is not available.

The Sub-Fund's general investment approach (Sub-Fund's applicable General Asset Class Principles in combination with its individual investment restrictions) is described in the prospectus.

● What are the binding elements of the investment strategy used to select the investments to attain each of the environmental or social characteristics promoted by this financial product?

The binding elements are:

- Min. 80% KPI coverage of the Sub-Fund's Portfolio (Portfolio in this respect does not comprise derivatives and instruments that are non-evaluated by nature (e. g., cash and deposits)).
- Min. 20% outperformance of benchmark in terms of Weighted Average GHG Intensity.
- Application of the following sustainable minimum exclusion criteria for direct investments:
 - securities issued by companies having a severe violation / breach of principles and guidelines such as the Principles of the United Nations Global Compact, the OECD Guidelines for Multinational Enterprises, and the United Nations Guiding Principles for Business and Human Rights on the grounds of problematic practices around human rights, labour rights, environment, and corruption issues,
 - securities issued by companies involved in controversial weapons (anti-personnel mines, cluster munitions, chemical weapons, biological weapons, depleted uranium, white phosphorus, and nuclear weapons),
 - securities issued by companies that derive more than 10% of their revenues from weapons, military equipment, and services,
 - securities issued by companies that derive more than 10% of their revenue from thermal coal extraction,
 - securities issued by utility companies that generate more than 20% of their revenues from coal,
 - securities issued by companies involved in the production of tobacco, and securities issued by companies involved in the distribution of tobacco with more than 5% of their revenues.

Direct investments in sovereign issuers with an insufficient freedom house index score are excluded.

The sustainable minimum exclusion criteria are based on information from an external data provider and coded in pre- and post-trade compliance. The review is performed at least half yearly.

- **What is the committed minimum rate to reduce the scope of the investments considered prior to the application of that investment strategy?**

The Sub-Fund does not commit to reduce the scope of the investments by a certain minimum rate.

- **What is the policy to assess good governance practices of the investee companies?**

Good governance principles are considered by screening out companies based on their involvement in controversies around international norms corresponding to the four good governance practices: sound management structures, employee relations, remuneration of staff and tax compliance. Companies having a severe violation in either of those areas will not be investible. For certain cases, flagged issuers shall be on a watch list. These companies will appear on this watch list when the Investment Manager believes that engagement may lead to improvements or when the company is assessed to take remedial actions. Companies on the watch list remain investible unless the Investment Manager believes that the engagement or the remedial actions of the company does not lead to the desired remedy of the severe controversy.

In addition, the Sub-Fund's Investment Manager is committed to actively encourage open dialogues with investee companies on corporate governance, proxy voting and broader sustainability issues in advance of shareholder meetings (regularly for direct investments in shares). The Sub-Fund's Investment Manager's approach to proxy voting and company engagement is set out in the Management Company's Stewardship Statement.

Good governance practices include sound management structures, employee relations, remuneration of staff and tax compliance.



What is the asset allocation planned for this financial product?

Asset allocation describes the share of investments in specific assets.

Min. 80% of the Sub-Funds' assets (excluding cash, and derivatives) are used to meet the environmental or social characteristics promoted by this Sub-Fund. A low portion of the Sub-Fund might contain assets which do not promote environmental or social characteristics. Examples of such instruments are derivatives, cash and deposits, some Target Funds and investment with temporarily divergent or absent environmental, social, or good governance qualifications. Min. 2.50% of the Sub-Funds' assets will be invested in Sustainable Investments. The minimum percentage of investments that are aligned with the EU Taxonomy is 0.01%. The Sub-Fund's Investment Manager does not commit to a minimum share of environmentally Sustainable Investments that are not aligned with the EU Taxonomy. The Sub-Fund's Investment Manager does not commit to a minimum share of socially sustainable investments. While the Sub-Fund cannot commit to a minimum share of environmentally or socially sustainable investments, such investments may be freely allocated to within the Sub-Fund aggregated sustainable investment commitment disclosed (min. 2,50%).

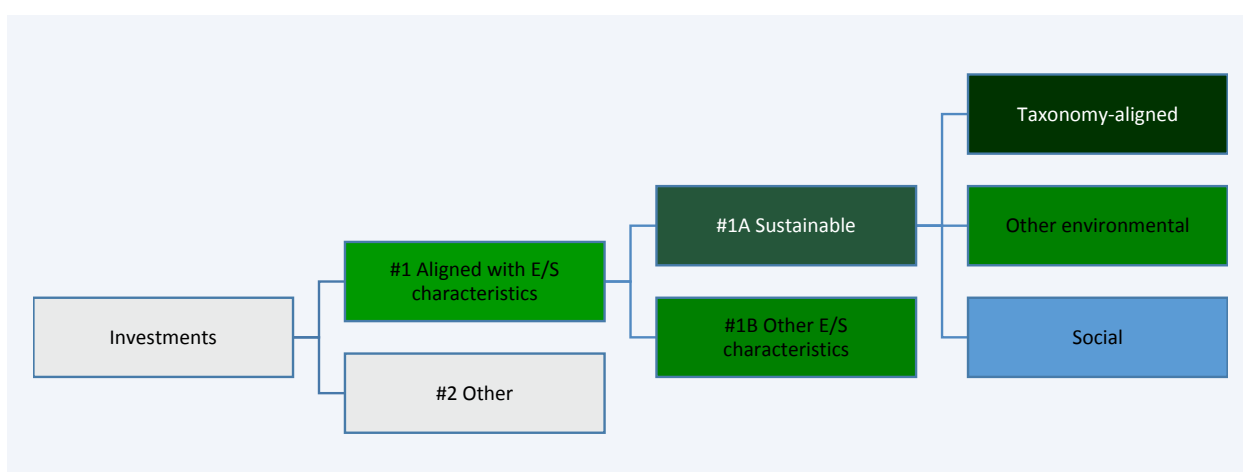

#1 Aligned with E/S characteristics includes the investments of the financial product used to attain the environmental or social characteristics promoted by the financial product.

#2 Other includes the remaining investments of the financial product which are neither aligned with the environmental or social characteristics, nor are qualified as sustainable investments.

The category **#1 Aligned with E/S characteristics** covers:

- The sub-category **#1A Sustainable** covers sustainable investments with environmental or social objectives.
- The sub-category **#1B Other E/S characteristics** covers investments aligned with the environmental or social characteristics that do not qualify as sustainable investments.

- How does the use of derivatives attain the environmental or social characteristics promoted by the financial product?

Not applicable



To what minimum extent are sustainable investments with an environmental objective aligned with the EU Taxonomy?

The Taxonomy-aligned investments include debt and/or equity in environmentally sustainable economic activities aligned with the EU-Taxonomy. The minimum percentage of investments that are aligned with the EU Taxonomy is 0.01%. Taxonomy-aligned data is provided by an external data provider. The Investment Manager has assessed the quality of such data. The data will not be subject to an assurance provided by auditors or a review by third parties. The data will not reflect any data in government bonds. As of today, there is no recognized methodology available to determine the proportion of Taxonomy-aligned activities when investing in government bonds.

Taxonomy-aligned activities in this disclosure are based on share of turnover. Pre-contractual figures use turnover as its financial metric as a default in line with the regulatory requirements and based on the fact that complete, verifiable or up-to date data for CAPEX and/or OPEX as financial metric is even less available.

Taxonomy-aligned data is only in rare cases data reported by companies in accordance with the EU Taxonomy. The data provider has derived Taxonomy-aligned data from other available equivalent public data.

- Does the financial product invest in fossil gas and/or nuclear energy related activities that comply with the EU Taxonomy ¹?

Yes:
 In fossil gas In nuclear energy
 No

The Sub-Fund does not pursue any investments in fossil gas and/or nuclear energy related activities that comply with the EU Taxonomy. Nevertheless, as result of this investment strategy, investments may occur in corporates which are also active in these activities. Further information will be provided as part of the annual reporting, if relevant.

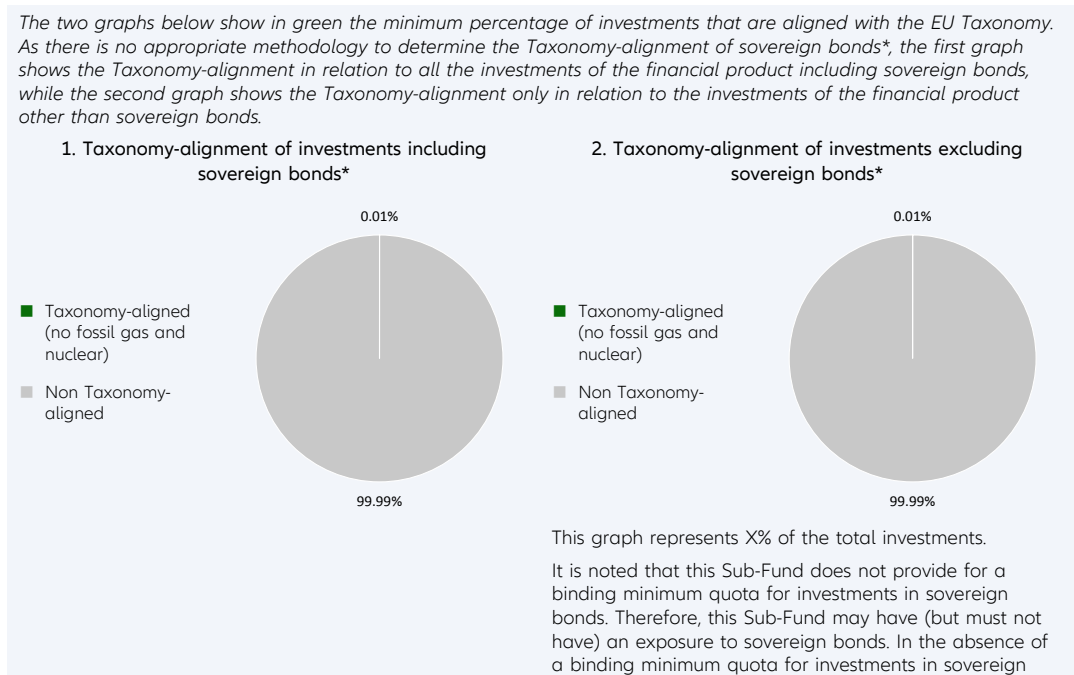

Taxonomy-aligned activities are expressed as a share of:
 - **turnover** reflecting the share of revenue from green activities of investee companies
 - **capital expenditure** (CapEx) showing the green investments made by investee companies, e.g. for a transition to a green economy.
 - **operational expenditure** (OpEx) reflecting green operational activities of investee companies.

¹ Fossil gas and/or nuclear related activities will only comply with the EU Taxonomy where they contribute to limiting climate change ("climate change mitigation") and do not significantly harm any EU Taxonomy objective - see explanatory note in the left hand margin. The full criteria for fossil gas and nuclear energy economic activities that comply with the EU Taxonomy are laid down in Commission Delegated Regulation (EU) 2022/1214.

bonds, this graph does not generate any additional added value compared to the left-hand graph.

* For the purpose of these graphs, 'sovereign bonds' consist of all sovereign exposures

Enabling activities directly enable other activities to make a substantial contribution to an environmental objective.

Transitional activities are activities for which low-carbon alternatives are not yet available and among others have greenhouse gas emission levels corresponding to the best performance.

● What is the minimum share of investments in transitional and enabling activities?

The Sub-Fund's Investment Manager does not commit to a split of minimum taxonomy alignment into transitional, enabling activities and own performance.



What is the minimum share of sustainable investments with an environmental objective that are not aligned with the EU Taxonomy?

Taxonomy-aligned investments are considered a sub-category of Sustainable Investments. If an investment is not Taxonomy-aligned since the activity is not yet covered under the EU Taxonomy or the positive contribution is not substantial enough to comply with the Taxonomy technical screening criteria, the investment can still be considered an environmentally Sustainable Investment provided it complies with all criteria. The Investment Manager does not commit to a minimum share of environmentally Sustainable Investments that are not aligned with the EU Taxonomy. The overall sustainable investment share may also include investments with an environmental objective in economic activities that do not qualify as environmentally sustainable under the EU Taxonomy, and while the Sub-Fund cannot commit to a minimum share of environmentally or socially sustainable investments, such investments may be freely allocated to within the Sub-Fund aggregated sustainable investment commitment disclosed (min. 2,50%).



are sustainable investments with an environmental objective that **do not take into account the criteria** for environmentally sustainable economic activities under the EU Taxonomy.



What is the minimum share of socially sustainable investments?

The Investment Manager defines Sustainable Investments based on internal research, which uses, among others, the UN Sustainable Development Goals (SDGs), as well as the objectives of the EU Taxonomy as reference frameworks. The Investment Manager does not commit to a minimum share of socially Sustainable Investments, as the SDGs contain environmental as well as social objectives. The overall sustainable investment share may also include investments with a social objective, and while the Sub-Fund cannot commit to a minimum share of environmentally or socially sustainable investments, such investments may be freely allocated to within the Sub-Fund aggregated sustainable investment commitment disclosed (min. 2,50%).



What investments are included under “#2 Other”, what is their purpose and are there any minimum environmental or social safeguards?

Under “#2 Other” investments into cash, Target Funds, or derivatives can be included. Derivatives might be used for efficient portfolio management (including risk hedging) and/or investment purposes, and Target Funds to benefit from a specific strategy. For those investments no environmental or social safeguards are applied.



Is a specific index designated as a reference benchmark to determine whether this financial product is aligned with the environmental and/or social characteristics that it promotes?

Yes, the Sub-Fund has assigned the J.P. MORGAN JACI Composite Total Return as a benchmark. This benchmark is a market index. The Sub-Fund will promote environmental and social characteristics by outperforming the benchmark's Weighted Average GHG Intensity

Reference benchmarks are indexes to measure whether the financial product attains the environmental or social characteristics that they promote.

- **How is the reference benchmark continuously aligned with each of the environmental or social characteristics promoted by the financial product?**

The benchmark is a market index and does not incorporate environmental or social characteristics for index construction.

- **How is the alignment of the investment strategy with the methodology of the index ensured on a continuous basis?**

The benchmark is not continuously aligned as it does not incorporate environmental or social characteristics for index construction.

- **How does the designated index differ from a relevant broad market index?**

The benchmark is a broad market index.

- **Where can the methodology used for the calculation of the designated index be found?**

Details of the Benchmark's methodology may be found at www.jpmorgan.com



Where can I find more product specific information online?

More product-specific information can be found on the website: <https://regulatory.allianzgi.com/SFDR>

Template pre-contractual disclosure for the financial products referred to in Article 8, paragraphs 1, 2 and 2a, of Regulation (EU) 2019/2088 and Article 6, first paragraph, of Regulation (EU) 2020/852

Product name:

Allianz Floating Rate Notes Plus

Legal entity identifier: 549300MEQ2M0QYJV6F90

Environmental and/or social characteristics

Sustainable investment means an investment in an economic activity that contributes to an environmental or social objective, provided that the investment does not significantly harm any environmental or social objective and that the investee companies follow good governance practices.

The **EU Taxonomy** is a classification system laid down in Regulation (EU) 2020/852, establishing a list of **environmentally sustainable economic activities**. That Regulation does not include a list of socially sustainable economic activities. Sustainable investments with an environmental objective might be aligned with the Taxonomy or not.

Does this financial product have a sustainable investment objective?	
<input checked="" type="radio"/> <input checked="" type="radio"/> Yes	<input checked="" type="radio"/> <input type="radio"/> No
<input type="checkbox"/> It will make a minimum of sustainable investments with an environmental objective: ___% <ul style="list-style-type: none"> <input type="checkbox"/> in economic activities that qualify as environmentally sustainable under the EU Taxonomy <input type="checkbox"/> in economic activities that do not qualify as environmentally sustainable under the EU Taxonomy 	<input checked="" type="checkbox"/> It promotes Environmental/Social (E/S) characteristics and while it does not have as its objective a sustainable investment, it will have a minimum proportion of 3.00% of sustainable investments <ul style="list-style-type: none"> <input checked="" type="checkbox"/> with an environmental objective in economic activities that qualify as environmentally sustainable under the EU Taxonomy <input checked="" type="checkbox"/> with an environmental objective in economic activities that do not qualify as environmentally sustainable under the EU Taxonomy <input checked="" type="checkbox"/> with a social objective
<input type="checkbox"/> It will make a minimum of sustainable investments with a social objective ___%	<input type="checkbox"/> It promotes E/S characteristics, but will not make any sustainable investments



What environmental and/or social characteristics are promoted by this financial product?

Allianz Floating Rate Notes Plus (the "Sub-Fund") promotes environmental, social, human rights, governance, and business behaviour factors (this domain does not apply for sovereigns issued by a Sovereign Entity) through integration of a best-in-class approach into the Sub-Fund's investment process. This encompasses the evaluation of corporate or sovereign issuers based on an SRI Rating which is used to construct the portfolio.

In addition, sustainable minimum exclusion criteria apply.

No reference benchmark has been designated for the purpose of attaining the environmental and/or social characteristics promoted by the Sub-Fund.

● What sustainability indicators are used to measure the attainment of each of the environmental or social characteristics promoted by this financial product?

To measure the attainment of the environmental and/or social characteristics the following sustainability indicators are used and reported on, at the fiscal year end:

- The actual percentage of the Sub-Fund's Portfolio (Portfolio in this respect does not comprise non-rated derivatives and instruments that are non-rated by nature (e. g., cash and deposits)) assets invested in best-in-class issuers (issuers with a minimum SRI Rating of 2 out of a scale from 0-4; 0 being the worst rating and 4 the best rating).
- Confirmation that Principal Adverse Impacts (PAIs) of investment decisions on sustainability factors are considered through the application of exclusion criteria.

Sustainability indicators measure how the environmental or social characteristics promoted by the financial product are attained.

● **What are the objectives of the sustainable investments that the financial product partially intends to make and how does the sustainable investment contribute to such objectives?**

Sustainable investments contribute to environmental and/or social objectives, for which the Investment Manager uses as reference frameworks, among others, the UN Sustainable Development Goals (SDGs), as well as the objectives of the EU Taxonomy:

1. Climate Change Mitigation
2. Climate Change Adaptation
3. Sustainable Use and Protection of Water and Marine Resources
4. Transition to a Circular Economy
5. Pollution Prevention and Control
6. Protection and Restoration of Biodiversity and Ecosystems

The assessment of the positive contribution to the environmental or social objectives is based on a proprietary framework which combines quantitative elements with qualitative inputs from internal research. The methodology applies first a quantitative breakdown of a securities issuer into its business activities. The qualitative element of the framework is an assessment if business activities contribute positively to an environmental or a social objective.

To calculate the positive contribution on the Sub-Fund level the revenue share of each issuer attributable to business activities contributing to environmental and/or social objectives is considered provided the issuer is satisfying the Do No Significant Harm (“DNSH”) and Good Governance principles, and an asset-weighted aggregation is performed as a second step. Moreover, for certain types of securities, which finance specific projects contributing to environmental or social objectives the overall investment is considered to contribute to environmental and/or social objectives, but also for these a DNSH as well as a Good Governance check for issuers is performed.

● **How do the sustainable investments that the financial product partially intends to make, not cause significant harm to any environmental or social sustainable investment objective?**

In order to ensure that Sustainable Investments do not significantly harm any other environmental and/or social objective, the Investment Manager is leveraging the PAI indicators, whereby significance thresholds have been defined to identify significantly harmful issuers. Issuers not meeting the significance threshold can be engaged for a limited time period to remediate the adverse impact. Otherwise, if the issuer does not meet the defined significance thresholds twice subsequently or in case of a failed engagement, it does not pass the DNSH assessment. Investments in securities of issuers which do not pass the DNSH assessment are not counted as sustainable investments.

● *How have the indicators for adverse impacts on sustainability factors been taken into account?*

All mandatory PAI indicators are considered either as part of the application of the exclusion criteria or through thresholds on a sectorial or absolute basis. Significance thresholds have been defined and they refer to qualitative or quantitative criteria.

Recognizing the lack of data coverage for some of the PAI indicators equivalent data points are used to assess PAI indicators when applying the DNSH assessment, when relevant, for the following indicators for corporates: share of non-renewable energy consumption and production, activities negatively affecting biodiversity-sensitive areas, emissions to water, lack of processes and compliance mechanisms to monitor compliance with UNGC principles and OECD Guidelines for Multinational Enterprises; for sovereigns: GHG Intensity and investee countries subject to social violations. In case of securities which finance specific projects contributing to environmental or social objectives equivalent data at project level might be used to ensure that Sustainable Investments do not significantly harm any other environmental and/or social objective. The Investment Manager will strive to increase data coverage for PAI indicators with low data coverage by engaging with issuers and data providers. The Investment Manager will regularly evaluate whether the availability of data has increased sufficiently to potentially include assessment of such data in the investment process.

● *How are the sustainable investments aligned with the OECD Guidelines for Multinational Enterprises and the UN Guiding Principles on Business and Human Rights? Details:*

The Investment Manager’s sustainable minimum exclusion list screens out companies based on their involvement in controversial practices against international norms. The core normative framework consists of the Principles of the UN Global Compact, the OECD Guidelines for Multinational Enterprises

Principal adverse impacts are the most significant negative impacts of investment decisions on sustainability factors relating to environmental, social and employee matters, respect for human rights, anti-corruption and anti-bribery matters.

and the UN Guiding Principles for Business and Human Rights. Securities issued by companies having a severe violation of these frameworks will be restricted from the investment universe.

The EU Taxonomy sets out a “do not significant harm” principle by which Taxonomy-aligned investments should not significantly harm EU Taxonomy objectives and is accompanied by specific EU criteria.

The “do not significant harm” principle applies only to those investments underlying the financial product that take into account the EU criteria for environmentally sustainable economic activities. The investments underlying the remaining portion of this financial product do not take into account the EU criteria for environmentally sustainable economic activities.

Any other sustainable investments must also not significantly harm any environmental or social objectives.



Does this financial product consider principal adverse impacts on sustainability factors?

Yes

No

The Management Company has joined the Net Zero Asset Manager Initiative and considers PAI indicators through stewardship including engagement, both are relevant to mitigate potential adverse impact as a company.

Due to the commitment to the Net Zero Asset Manager Initiative, the Management Company aims to reduce greenhouse gas emissions in partnership with asset owner clients on decarbonisation goals, consistent with an ambition to reach net zero emission by 2050 or sooner across all assets under management. As part of this objective the Management Company will set an interim target for the proportion of assets to be managed in line with the attainment of net zero emissions by 2050 or sooner.

The Sub-Fund’s Investment Manager considers PAI indicators regarding greenhouse gas emission, biodiversity, water, waste as well as social and employee matters for corporate issuers, and, where relevant, the freedom house index is applied to investments in sovereigns. PAI indicators are considered within the Investment Manager’s investment process through the means of exclusions as described in the “binding elements” section of the Sub-Fund.

The data coverage for the data required for the PAI indicators is heterogenous. The data coverage related to biodiversity, water and waste is low and the related PAI indicators are considered through exclusion of securities issued by companies having a severe violation / breach of principles and guidelines such as the Principles of the United Nations Global Compact, the OECD Guidelines for Multinational Enterprises, and the United Nations Guiding Principles for Business and Human Rights on the grounds of problematic practices around human rights, labour rights, environment, and corruption issues. Therefore, the Investment Manager will strive to increase data coverage for PAI indicators with low data coverage. The Investment Manager will regularly evaluate whether the availability of data has increased sufficiently to potentially include assessment of such data in the investment process.

Additionally, PAI indicators are, among other sustainability factors, applied to derive the SRI Rating. The SRI Rating is used for the portfolio construction.

The following PAI indicators are considered:

Applicable to corporate issuers

- GHG Emissions
- Carbon footprint
- GHG Intensity of investee companies
- Exposure to companies active in the fossil fuel sector
- Activities negatively affecting biodiversity-sensitive areas
- Emissions to water
- Hazardous waste ratio
- Violation of UN Global compact principles
- Lack of processes and compliance mechanisms to monitor compliance with UN Global Compact principles
- Board gender diversity
- Exposure to controversial weapons

Applicable to sovereign and supranational issuers

- Investee countries subject to social violations

The information on the PAI indicators will be available in the end-year report of the Sub-Fund.



What investment strategy does this financial product follow?

The investment strategy guides investment decisions based on factors such as investment objectives and risk tolerance.

Allianz Floating Rate Notes Plus' investment objective is to invest in global bond markets with a focus on floating-rate notes with Euro exposure in accordance with the Sustainable and Responsible Investment Strategy (SRI Strategy).

As part of the SRI best-in-class approach, the Sub-Fund takes environmental, social, human rights, governance, and business behaviour factors into account as follows:

- The aforesaid sustainability factors are analysed through SRI Research by the Investment Manager in order to assess how sustainable development and long-term issues are taken into account in the strategy of an issuer. SRI Research means the overall process of identifying potential risks as well as potential opportunities of an investment in securities of an issuer related to the analysis of sustainability factors. SRI Research data combines external research data (which might have some limitations) with internal analyses.
- Based on a combination of the results of the external and/or internal analyses of the sustainability factors, an internal rating is derived monthly (SRI Rating) and is afterwards assigned to a corporate or sovereign issuer.

This internal SRI Rating is used to rank and select or weight securities for the portfolio construction.

The Sub-Fund's general investment approach (Sub-Fund's applicable General Asset Class Principles in combination with its individual investment restrictions) is described in the prospectus.

● What are the binding elements of the investment strategy used to select the investments to attain each of the environmental or social characteristics promoted by this financial product?

The binding elements are:

- Minimum rating coverage: At least 90% of the Sub-Fund's portfolio is required to have an SRI Rating (portfolio in this respect does not comprise non-rated derivatives and instruments that are non-rated by nature e.g., cash and deposits). While most holdings of the Sub-Fund will have a corresponding SRI Rating some investments cannot be rated according to the SRI Research methodology. Examples of instruments not attaining to the SRI Rating include, but are not limited to cash, deposits, Target Funds, and non-rated investments.
- The rated instruments are adhering to the minimum rating threshold of 1 (out of a rating scale from 0 – 4; 0 being the worst rating and 4 the best rating).
- Application of the following sustainable minimum exclusion criteria for direct investments:
 - securities issued by companies having a severe violation / breach of principles and guidelines such as the Principles of the United Nations Global Compact, the OECD Guidelines for Multinational Enterprises, and the United Nations Guiding Principles for Business and Human Rights on the grounds of problematic practices around human rights, labour rights, environment, and corruption issues,
 - securities issued by companies involved in controversial weapons (anti-personnel mines, cluster munitions, chemical weapons, biological weapons, depleted uranium, white phosphorus, and nuclear weapons),
 - securities issued by companies that derive more than 10% of their revenues from weapons, military equipment, and services,
 - securities issued by companies that derive more than 10% of their revenue from thermal coal extraction,
 - securities issued by utility companies that generate more than 20% of their revenues from coal,
 - securities issued by companies involved in the production of tobacco, and securities issued by companies involved in the distribution of tobacco with more than 5% of their revenues.

Direct investments in sovereign issuers with an insufficient freedom house index score are excluded.

The sustainable minimum exclusion criteria are based on information from an external data provider and coded in pre- and post-trade compliance. The review is performed at least half yearly.

- **What is the committed minimum rate to reduce the scope of the investments considered prior to the application of that investment strategy?**

The Sub-Fund does not commit to reduce the scope of the investments by a certain minimum rate.

- **What is the policy to assess good governance practices of the investee companies?**

Good governance principles are considered by screening out companies based on their involvement in controversies around international norms corresponding to the four good governance practices: sound management structures, employee relations, remuneration of staff and tax compliance. Companies having a severe violation in either of those areas will not be investible. For certain cases, flagged issuers shall be on a watch list. These companies will appear on this watch list when the Investment Manager believes that engagement may lead to improvements or when the company is assessed to take remedial actions. Companies on the watch list remain investible unless the Investment Manager believes that the engagement or the remedial actions of the company does not lead to the desired remedy of the severe controversy.

In addition, the Sub-Fund's Investment Manager is committed to actively encourage open dialogues with investee companies on corporate governance, proxy voting and broader sustainability issues in advance of shareholder meetings (regularly for direct investments in shares). The Sub-Fund's Investment Manager's approach to proxy voting and company engagement is set out in the Management Company's Stewardship Statement.

Good governance practices include sound management structures, employee relations, remuneration of staff and tax compliance.



What is the asset allocation planned for this financial product?

Asset allocation describes the share of investments in specific assets.

Min. 90% of the Sub-Funds' assets (excluding cash and non-rated derivatives) are used to meet the environmental or social characteristics promoted by this Sub-Fund. A low portion of the Sub-Fund might contain assets which do not promote environmental or social characteristics. Examples of such instruments are derivatives, cash and deposits, some Target Funds and investment with temporarily divergent or absent environmental, social, or good governance qualifications. Min. 3% of the Sub-Funds' assets will be invested in Sustainable Investments. The minimum percentage of investments that are aligned with the EU Taxonomy is 0.01%. The Sub-Fund's Investment Manager does not commit to a minimum share of environmentally Sustainable Investments that are not aligned with the EU Taxonomy. The Sub-Fund's Investment Manager does not commit to a minimum share of socially sustainable investments. While the Sub-Fund cannot commit to a minimum share of environmentally or socially sustainable investments, such investments may be freely allocated to within the Sub-Fund aggregated sustainable investment commitment disclosed (min. 3%).

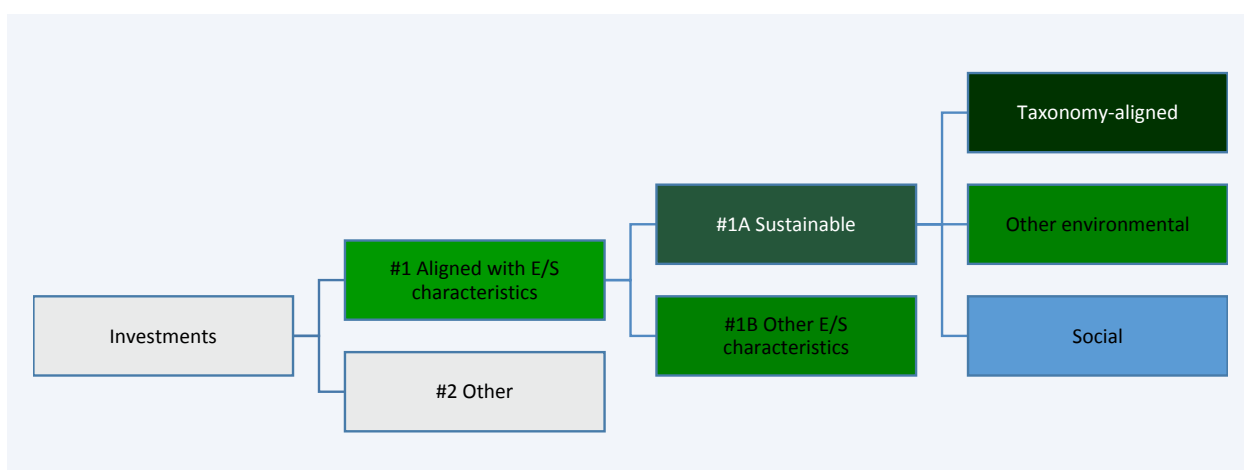

#1 Aligned with E/S characteristics includes the investments of the financial product used to attain the environmental or social characteristics promoted by the financial product.

#2 Other includes the remaining investments of the financial product which are neither aligned with the environmental or social characteristics, nor are qualified as sustainable investments.

The category **#1 Aligned with E/S characteristics** covers:

- The sub-category **#1A Sustainable** covers sustainable investments with environmental or social objectives.
- The sub-category **#1B Other E/S characteristics** covers investments aligned with the environmental or social characteristics that do not qualify as sustainable investments.

- **How does the use of derivatives attain the environmental or social characteristics promoted by the financial product?**

Not applicable



To what minimum extent are sustainable investments with an environmental objective aligned with the EU Taxonomy?

The Taxonomy-aligned investments include debt and/or equity in environmentally sustainable economic activities aligned with the EU-Taxonomy. The minimum percentage of investments that are aligned with the EU Taxonomy is 0.01%. Taxonomy-aligned data is provided by an external data provider. The Investment Manager has assessed the quality of such data. The data will not be subject to an assurance provided by auditors or a review by third parties. The data will not reflect any data in government bonds. As of today, there is no recognized methodology available to determine the proportion of Taxonomy-aligned activities when investing in government bonds.

Taxonomy-aligned activities in this disclosure are based on share of turnover. Pre-contractual figures use turnover as its financial metric as a default in line with the regulatory requirements and based on the fact that complete, verifiable or up-to date data for CAPEX and/or OPEX as financial metric is even less available.

Taxonomy-aligned data is only in rare cases data reported by companies in accordance with the EU Taxonomy. The data provider has derived Taxonomy-aligned data from other available equivalent public data.

- **Does the financial product invest in fossil gas and/or nuclear energy related activities that comply with the EU Taxonomy¹?**

Yes:

In fossil gas In nuclear energy

No

The Sub-Fund does not pursue any investments in fossil gas and/or nuclear energy related activities that comply with the EU Taxonomy. Nevertheless, as result of this investment strategy, investments may occur in corporates which are also active in these activities. Further information will be provided as part of the annual reporting, if relevant.

The two graphs below show in green the minimum percentage of investments that are aligned with the EU Taxonomy. As there is no appropriate methodology to determine the Taxonomy-alignment of sovereign bonds, the first graph shows the Taxonomy-alignment in relation to all the investments of the financial product including sovereign bonds, while the second graph shows the Taxonomy-alignment only in relation to the investments of the financial product other than sovereign bonds.*

1. Taxonomy-alignment of investments including sovereign bonds*

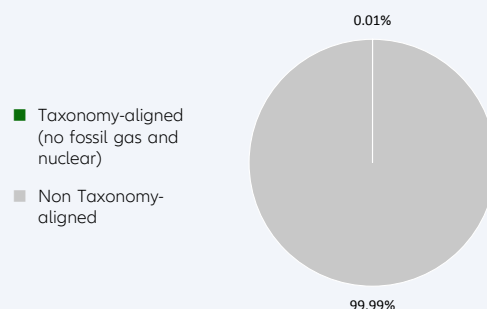

2. Taxonomy-alignment of investments excluding sovereign bonds*

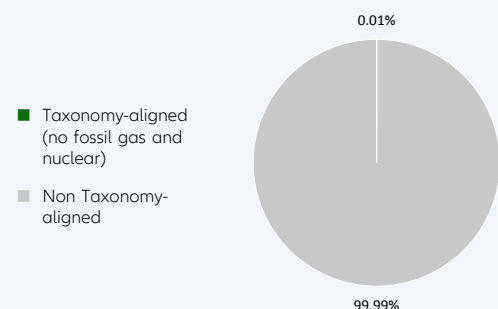

This graph represents X% of the total investments.

It is noted that this Sub-Fund does not provide for a binding minimum quota for investments in sovereign bonds. Therefore, this Sub-Fund may have (but must not have) an exposure to sovereign bonds. In the absence of a binding minimum quota for investments in sovereign

Taxonomy-aligned activities are expressed as a share of:

- **turnover** reflecting the share of revenue from green activities of investee companies
- **capital expenditure** (CapEx) showing the green investments made by investee companies, e.g. for a transition to a green economy.
- **operational expenditure** (OpEx) reflecting green operational activities of investee companies.

¹ Fossil gas and/or nuclear related activities will only comply with the EU Taxonomy where they contribute to limiting climate change ("climate change mitigation") and do not significantly harm any EU Taxonomy objective - see explanatory note in the left hand margin. The full criteria for fossil gas and nuclear energy economic activities that comply with the EU Taxonomy are laid down in Commission Delegated Regulation (EU) 2022/1214.

bonds, this graph does not generate any additional added value compared to the left-hand graph.

* For the purpose of these graphs, 'sovereign bonds' consist of all sovereign exposures

Enabling activities directly enable other activities to make a substantial contribution to an environmental objective.

Transitional activities are activities for which low-carbon alternatives are not yet available and among others have greenhouse gas emission levels corresponding to the best performance.

● What is the minimum share of investments in transitional and enabling activities?

The Sub-Fund's Investment Manager does not commit to a split of minimum taxonomy alignment into transitional, enabling activities and own performance.



What is the minimum share of sustainable investments with an environmental objective that are not aligned with the EU Taxonomy?

Taxonomy-aligned investments are considered a sub-category of Sustainable Investments. If an investment is not Taxonomy-aligned since the activity is not yet covered under the EU Taxonomy or the positive contribution is not substantial enough to comply with the Taxonomy technical screening criteria, the investment can still be considered an environmentally Sustainable Investment provided it complies with all criteria. The Investment Manager does not commit to a minimum share of environmentally Sustainable Investments that are not aligned with the EU Taxonomy. The overall sustainable investment share may also include investments with an environmental objective in economic activities that do not qualify as environmentally sustainable under the EU Taxonomy, and while the Sub-Fund cannot commit to a minimum share of environmentally or socially sustainable investments, such investments may be freely allocated to within the Sub-Fund aggregated sustainable investment commitment disclosed (min. 3%).



are sustainable investments with an environmental objective that **do not take into account the criteria** for environmentally sustainable economic activities under the EU Taxonomy.



What is the minimum share of socially sustainable investments?

The Investment Manager defines Sustainable Investments based on internal research, which uses, among others, the UN Sustainable Development Goals (SDGs), as well as the objectives of the EU Taxonomy as reference frameworks. The Investment Manager does not commit to a minimum share of socially Sustainable Investments, as the SDGs contain environmental as well as social objectives. The overall sustainable investment share may also include investments with a social objective, and while the Sub-Fund cannot commit to a minimum share of environmentally or socially sustainable investments, such investments may be freely allocated to within the Sub-Fund aggregated sustainable investment commitment disclosed (min. 3%).



What investments are included under “#2 Other”, what is their purpose and are there any minimum environmental or social safeguards?

Under “#2 Other” investments into cash, Target Funds, or derivatives can be included. Derivatives might be used for efficient portfolio management (including risk hedging) and/or investment purposes, and Target Funds to benefit from a specific strategy. For those investments no environmental or social safeguards are applied.



Is a specific index designated as a reference benchmark to determine whether this financial product is aligned with the environmental and/or social characteristics that it promotes?

No reference benchmark has been designated for the purpose of attaining the environmental and/or social characteristics promoted by the Sub-Fund.

Reference benchmarks are indexes to measure whether the financial product attains the environmental or social characteristics that they promote.

- **How is the reference benchmark continuously aligned with each of the environmental or social characteristics promoted by the financial product?**
Not applicable
- **How is the alignment of the investment strategy with the methodology of the index ensured on a continuous basis?**
Not applicable
- **How does the designated index differ from a relevant broad market index?**
Not applicable
- **Where can the methodology used for the calculation of the designated index be found?**
Not applicable



Where can I find more product specific information online?

More product-specific information can be found on the website: <https://regulatory.allianzgi.com/SFDR>

Template pre-contractual disclosure for the financial products referred to in Article 8, paragraphs 1, 2 and 2a, of Regulation (EU) 2019/2088 and Article 6, first paragraph, of Regulation (EU) 2020/852

Product name:

Allianz Food Security

Legal entity identifier: 5299001E4VA6IBICG293

Environmental and/or social characteristics

Sustainable investment means an investment in an economic activity that contributes to an environmental or social objective, provided that the investment does not significantly harm any environmental or social objective and that the investee companies follow good governance practices.

The EU Taxonomy is a classification system laid down in Regulation (EU) 2020/852, establishing a list of environmentally sustainable economic activities. That Regulation does not include a list of socially sustainable economic activities. Sustainable investments with an environmental objective might be aligned with the Taxonomy or not.

Does this financial product have a sustainable investment objective?	
<input checked="" type="radio"/> <input checked="" type="radio"/> Yes	<input checked="" type="radio"/> <input type="radio"/> No
<input type="checkbox"/> It will make a minimum of sustainable investments with an environmental objective: ___% <ul style="list-style-type: none"> <input type="checkbox"/> in economic activities that qualify as environmentally sustainable under the EU Taxonomy <input type="checkbox"/> in economic activities that do not qualify as environmentally sustainable under the EU Taxonomy 	<input checked="" type="checkbox"/> It promotes Environmental/Social (E/S) characteristics and while it does not have as its objective a sustainable investment, it will have a minimum proportion of 50.00% of sustainable investments <ul style="list-style-type: none"> <input checked="" type="checkbox"/> with an environmental objective in economic activities that qualify as environmentally sustainable under the EU Taxonomy <input checked="" type="checkbox"/> with an environmental objective in economic activities that do not qualify as environmentally sustainable under the EU Taxonomy <input checked="" type="checkbox"/> with a social objective
<input type="checkbox"/> It will make a minimum of sustainable investments with a social objective ___% <ul style="list-style-type: none"> <input type="checkbox"/> in economic activities that qualify as environmentally sustainable under the EU Taxonomy <input type="checkbox"/> in economic activities that do not qualify as environmentally sustainable under the EU Taxonomy 	<input type="checkbox"/> It promotes E/S characteristics, but will not make any sustainable investments <ul style="list-style-type: none"> <input type="checkbox"/> with an environmental objective in economic activities that qualify as environmentally sustainable under the EU Taxonomy <input type="checkbox"/> with an environmental objective in economic activities that do not qualify as environmentally sustainable under the EU Taxonomy <input type="checkbox"/> with a social objective



What environmental and/or social characteristics are promoted by this financial product?

Allianz Food Security's (the "Sub-Fund") invests in securities of companies providing products or services which contribute to environmental or social objectives, as defined by the UN Sustainable Development Goals (SDGs) or the EU Taxonomy objectives, which are also related to the SDGs. The contribution is measured according to the Sustainable Investment methodology.

In addition, sustainable minimum exclusion criteria apply.

No reference benchmark has been designated for the purpose of attaining the environmental and/or social characteristics promoted by the Sub-Fund.

What sustainability indicators are used to measure the attainment of each of the environmental or social characteristics promoted by this financial product?

To measure the attainment of the Sub-Fund's sustainable investment objective the following sustainability indicators are used and reported on, at the fiscal year end:

- The actual Sustainable Investment share – which is based on SDGs or EU Taxonomy objectives
- Principle Adverse Impacts (PAIs) of investment decisions on sustainability factors are considered through the application of exclusion criteria.

Sustainability indicators measure how the environmental or social characteristics promoted by the financial product are attained.

- **What are the objectives of the sustainable investments that the financial product partially intends to make and how does the sustainable investment contribute to such objectives?**

Sustainable investments contribute to environmental and/or social objectives, for which the Investment Manager uses as reference frameworks, among others, the UN Sustainable Development Goals (SDGs), as well as the objectives of the EU Taxonomy:

1. Climate Change Mitigation
2. Climate Change Adaptation
3. Sustainable Use and Protection of Water and Marine Resources
4. Transition to a Circular Economy
5. Pollution Prevention and Control
6. Protection and Restoration of Biodiversity and Ecosystems

The assessment of the positive contribution to the environmental or social objectives is based on a proprietary framework which combines quantitative elements with qualitative inputs from internal research. The methodology applies first a quantitative breakdown of a securities issuer into its business activities. The qualitative element of the framework is an assessment if business activities contribute positively to an environmental or a social objective.

To calculate the positive contribution on the Sub-Fund level the revenue share of each issuer attributable to business activities contributing to environmental and/or social objectives is considered provided the issuer is satisfying the Do No Significant Harm (“DNSH”) and Good Governance principles, and an asset-weighted aggregation is performed as a second step. Moreover, for certain types of securities, which finance specific projects contributing to environmental or social objectives the overall investment is considered to contribute to environmental and/or social objectives, but also for these a DNSH as well as a Good Governance check for issuers is performed.

- **How do the sustainable investments that the financial product partially intends to make, not cause significant harm to any environmental or social sustainable investment objective?**

In order to ensure that Sustainable Investments do not significantly harm any other environmental and/or social objective, the Investment Manager is leveraging the PAI indicators, whereby significance thresholds have been defined to identify significantly harmful issuers. Issuers not meeting the significance threshold can be engaged for a limited time period to remediate the adverse impact. Otherwise, if the issuer does not meet the defined significance thresholds twice subsequently or in case of a failed engagement, it does not pass the DNSH assessment. Investments in securities of issuers which do not pass the DNSH assessment are not counted as sustainable investments.

- *How have the indicators for adverse impacts on sustainability factors been taken into account?*

All mandatory PAI indicators are considered either as part of the application of the exclusion criteria or through thresholds on a sectorial or absolute basis. Significance thresholds have been defined and they refer to qualitative or quantitative criteria.

Recognizing the lack of data coverage for some of the PAI indicators equivalent data points are used to assess PAI indicators when applying the DNSH assessment, when relevant, for the following indicators for corporates: share of non-renewable energy consumption and production, activities negatively affecting biodiversity-sensitive areas, emissions to water, lack of processes and compliance mechanisms to monitor compliance with UNGC principles and OECD Guidelines for Multinational Enterprises; for sovereigns: GHG Intensity and investee countries subject to social violations. In case of securities which finance specific projects contributing to environmental or social objectives equivalent data at project level might be used to ensure that Sustainable Investments do not significantly harm any other environmental and/or social objective. The Investment Manager will strive to increase data coverage for PAI indicators with low data coverage by engaging with issuers and data providers. The Investment Manager will regularly evaluate whether the availability of data has increased sufficiently to potentially include assessment of such data in the investment process.

- *How are the sustainable investments aligned with the OECD Guidelines for Multinational Enterprises and the UN Guiding Principles on Business and Human Rights? Details:*

The Investment Manager’s sustainable minimum exclusion list screens out companies based on their involvement in controversial practices against international norms. The core normative framework consists of the Principles of the UN Global Compact, the OECD Guidelines for Multinational Enterprises

Principal adverse impacts are the most significant negative impacts of investment decisions on sustainability factors relating to environmental, social and employee matters, respect for human rights, anti-corruption and anti-bribery matters.

and the UN Guiding Principles for Business and Human Rights. Securities issued by companies having a severe violation of these frameworks will be restricted from the investment universe.

The EU Taxonomy sets out a “do not significant harm” principle by which Taxonomy-aligned investments should not significantly harm EU Taxonomy objectives and is accompanied by specific EU criteria.

The “do not significant harm” principle applies only to those investments underlying the financial product that take into account the EU criteria for environmentally sustainable economic activities. The investments underlying the remaining portion of this financial product do not take into account the EU criteria for environmentally sustainable economic activities.

Any other sustainable investments must also not significantly harm any environmental or social objectives.



Does this financial product consider principal adverse impacts on sustainability factors?

Yes

No

The Management Company has joined the Net Zero Asset Manager Initiative and considers PAI indicators through stewardship including engagement, both are relevant to mitigate potential adverse impact as a company.

Due to the commitment to the Net Zero Asset Manager Initiative, the Management Company aims to reduce greenhouse gas emissions in partnership with asset owner clients on decarbonisation goals, consistent with an ambition to reach net zero emission by 2050 or sooner across all assets under management. As part of this objective the Management Company will set an interim target for the proportion of assets to be managed in line with the attainment of net zero emissions by 2050 or sooner.

The Sub-Fund’s Investment Manager considers PAI indicators regarding greenhouse gas emission, biodiversity, water, waste as well as social and employee matters for corporate issuers, and, where relevant, the freedom house index is applied to investments in sovereigns. PAI indicators are considered within the Investment Manager’s investment process through the means of exclusions as described in the “binding elements” section of the Sub-Fund.

The data coverage for the data required for the PAI indicators is heterogenous. The data coverage related to biodiversity, water and waste is low and the related PAI indicators are considered through exclusion of securities issued by companies having a severe violation / breach of principles and guidelines such as the Principles of the United Nations Global Compact, the OECD Guidelines for Multinational Enterprises, and the United Nations Guiding Principles for Business and Human Rights on the grounds of problematic practices around human rights, labour rights, environment, and corruption issues. Therefore, the Investment Manager will strive to increase data coverage for PAI indicators with low data coverage. The Investment Manager will regularly evaluate whether the availability of data has increased sufficiently to potentially include assessment of such data in the investment process.

Additionally, PAI indicators are considered as part of the requirement of the Sub-Fund to invest 50% into Sustainable Investments. PAI indicators are used as part of the DNSH assessment. Investments in securities of issuers who do not pass the DNSH assessment are not counted as sustainable investments.

The following PAI indicators are considered:

Applicable to corporate issuers

- GHG Emissions
- Carbon footprint
- GHG Intensity of investee companies
- Exposure to companies active in the fossil fuel sector
- Share of non-renewable energy consumption and production
- Energy consumption intensity per high impact climate sector
- Activities negatively affecting biodiversity-sensitive areas
- Emissions to water
- Hazardous waste ratio
- Violation of UN Global compact principles

- Lack of processes and compliance mechanisms to monitor compliance with UN Global Compact principles
- Unadjusted gender pay gap
- Board gender diversity
- Exposure to controversial weapons

Applicable to sovereign and supranational issuers

- GHG Intensity
- Investee countries subject to social violations

The information on the PAI indicators will be available in the end-year report of the Sub-Fund.



What investment strategy does this financial product follow?

The investment strategy guides investment decisions based on factors such as investment objectives and risk tolerance.

Allianz Food Security's investment objective is to invest in global Equity Markets with a focus on companies with an engagement in the area of food security in accordance with the SDG-Aligned Strategy.

The Sub-Fund invests in Equities of companies which offer products and services across themes of food security. Companies engaging in the core theme of food security are companies which offer products or services that improve food management practices across the entire supply chain with the purpose of improving sustainability of the agricultural practices, natural resource efficiency, and affordability and quality of food as targeted by SDGs No. 2, 3, 6, 13, 14 and 15.

The Sub-Fund's general investment approach (Sub-Fund's applicable General Asset Class Principles in combination with its individual investment restrictions) is described in the prospectus.

● What are the binding elements of the investment strategy used to select the investments to attain each of the environmental or social characteristics promoted by this financial product?

The binding elements are:

- Minimum 50% of the Sub-Fund assets' weighted average shall result from revenue generated from issuers' activities that facilitate the achievement of one or more SDG or EU Taxonomy objectives as measured according to the Sustainable Investment methodology.
- For at least 80% of the Sub-Fund portfolio, the respective issuer shall have a minimum share of 20% Sustainable Investments. Cash and derivatives are excluded from the aforesaid thresholds.
- Application of the following sustainable minimum exclusion criteria for direct investments:
 - securities issued by companies having a severe violation / breach of principles and guidelines such as the Principles of the United Nations Global Compact, the OECD Guidelines for Multinational Enterprises, and the United Nations Guiding Principles for Business and Human Rights on the grounds of problematic practices around human rights, labour rights, environment, and corruption issues,
 - securities issued by companies involved in controversial weapons (anti-personnel mines, cluster munitions, chemical weapons, biological weapons, depleted uranium, white phosphorus, and nuclear weapons),
 - securities issued by companies that derive more than 10% of their revenues from weapons, military equipment, and services,
 - securities issued by companies that derive more than 10% of their revenue from thermal coal extraction,
 - securities issued by utility companies that generate more than 20% of their revenues from coal,
 - securities issued by companies involved in the production of tobacco, and securities issued by companies involved in the distribution of tobacco with more than 5% of their revenues.

Direct investments in sovereign issuers with an insufficient freedom house index score are excluded.

The sustainable minimum exclusion criteria are based on information from an external data provider and coded in pre- and post-trade compliance. The review is performed at least half yearly.

- **What is the committed minimum rate to reduce the scope of the investments considered prior to the application of that investment strategy?**

The Sub-Fund does not commit to reduce the scope of the investments by a certain minimum rate.

- **What is the policy to assess good governance practices of the investee companies?**

Good governance principles are considered by screening out companies based on their involvement in controversies around international norms corresponding to the four good governance practices: sound management structures, employee relations, remuneration of staff and tax compliance. Companies having a severe violation in either of those areas will not be investible. For certain cases, flagged issuers shall be on a watch list. These companies will appear on this watch list when the Investment Manager believes that engagement may lead to improvements or when the company is assessed to take remedial actions. Companies on the watch list remain investible unless the Investment Manager believes that the engagement or the remedial actions of the company does not lead to the desired remedy of the severe controversy.

In addition, the Sub-Fund’s Investment Manager is committed to actively encourage open dialogues with investee companies on corporate governance, proxy voting and broader sustainability issues in advance of shareholder meetings (regularly for direct investments in shares). The Sub-Fund’s Investment Manager’s approach to proxy voting and company engagement is set out in the Management Company’s Stewardship Statement.

Good governance practices include sound management structures, employee relations, remuneration of staff and tax compliance.



What is the asset allocation planned for this financial product?

Asset allocation describes the share of investments in specific assets.

Min. 80% of the Sub-Funds’ assets (excluding cash, and derivatives) are used to meet the environmental or social characteristics promoted by this Sub-Fund. A low portion of the Sub-Fund might contain assets which do not promote environmental or social characteristics. Example of such instruments are derivatives, cash and deposits, some Target Funds and investment with temporarily divergent or absent environmental, social, or good governance qualifications. The Sub-Fund invest primarily into securities which offer products and services to facilitate the achievements of the SDGs. Min. 50% of the Sub-Funds' assets will be invested in Sustainable Investments. The Sub-Fund’s Investment Manager does not commit to a minimum share of sustainable investments with an environmental objective aligned with the EU Taxonomy nor to a minimum share of environmentally Sustainable Investments that are not aligned with the EU Taxonomy. The Sub-Fund’s Investment Manager does not commit to a minimum share of socially sustainable investments. While the Sub-Fund cannot commit to a minimum share of environmentally or socially sustainable investments, such investments may be freely allocated to within the Sub-Fund aggregated sustainable investment commitment disclosed (min. 50%).

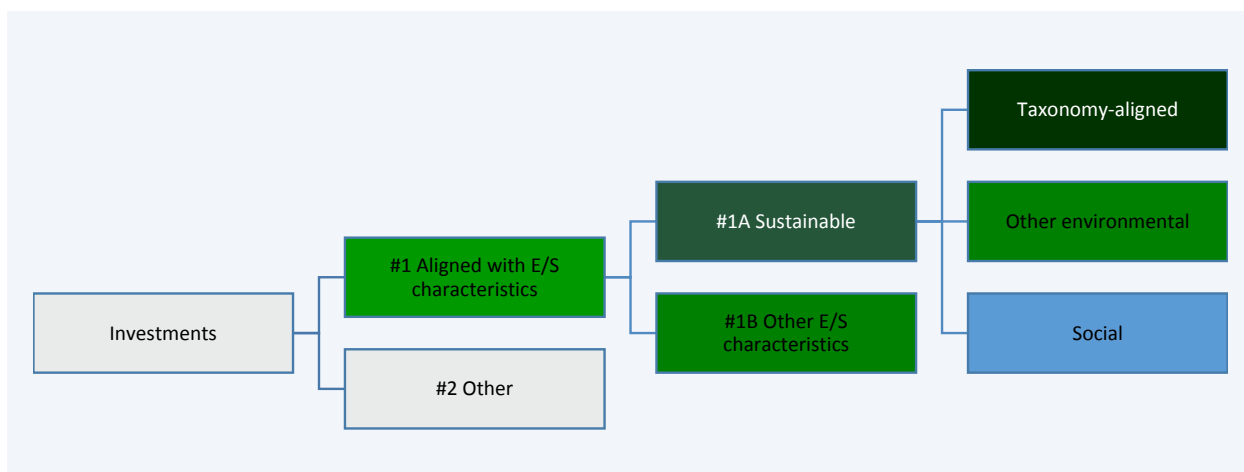

#1 Aligned with E/S characteristics includes the investments of the financial product used to attain the environmental or social characteristics promoted by the financial product.

#2 Other includes the remaining investments of the financial product which are neither aligned with the environmental or social characteristics, nor are qualified as sustainable investments.

The category **#1 Aligned with E/S characteristics** covers:

- The sub-category **#1A Sustainable** covers sustainable investments with environmental or social objectives.
- The sub-category **#1B Other E/S characteristics** covers investments aligned with the environmental or social characteristics that do not qualify as sustainable investments.

- How does the use of derivatives attain the environmental or social characteristics promoted by the financial product?

Not applicable



To what minimum extent are sustainable investments with an environmental objective aligned with the EU Taxonomy?

The Sub-Fund's Investment Manager does not commit to a minimum share of sustainable investments with an environmental objective aligned with the EU Taxonomy. The overall sustainable investment share may also include investments with an environmental objective in economic activities that qualify as environmentally sustainable under the EU Taxonomy.

- Does the financial product invest in fossil gas and/or nuclear energy related activities that comply with the EU Taxonomy¹?

- Yes:
- In fossil gas In nuclear energy
- No

The Sub-Fund does not pursue any investments in fossil gas and/or nuclear energy related activities that comply with the EU Taxonomy. Nevertheless, as result of this investment strategy, investments may occur in corporates which are also active in these activities. Further information will be provided as part of the annual reporting, if relevant.

The two graphs below show in green the minimum percentage of investments that are aligned with the EU Taxonomy. As there is no appropriate methodology to determine the Taxonomy-alignment of sovereign bonds*, the first graph shows the Taxonomy-alignment in relation to all the investments of the financial product including sovereign bonds, while the second graph shows the Taxonomy-alignment only in relation to the investments of the financial product other than sovereign bonds.

1. Taxonomy-alignment of investments including sovereign bonds*

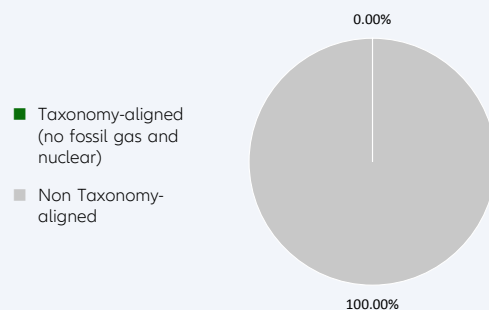

2. Taxonomy-alignment of investments excluding sovereign bonds*

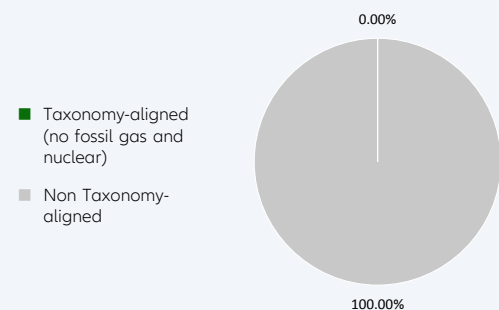

This graph represents X% of the total investments. It is noted that – due to the fact that this Sub-Fund does not provide for a minimum quota of taxonomy-aligned investments – this graph does not generate any additional added value compared to the left-hand graph.

* For the purpose of these graphs, 'sovereign bonds' consist of all sovereign exposures

- What is the minimum share of investments in transitional and enabling activities?

The Sub-Fund's Investment Manager does not commit to a split of minimum taxonomy alignment into transitional, enabling activities and own performance.

Taxonomy-aligned activities are expressed as a share of:

- **turnover** reflecting the share of revenue from green activities of investee companies
- **capital expenditure (CapEx)** showing the green investments made by investee companies, e.g. for a transition to a green economy.
- **operational expenditure (OpEx)** reflecting green operational activities of investee companies.

Enabling activities directly enable other activities to make a substantial contribution to an environmental objective.

Transitional activities are activities for which low-carbon alternatives are not yet available

¹ Fossil gas and/or nuclear related activities will only comply with the EU Taxonomy where they contribute to limiting climate change ("climate change mitigation") and do not significantly harm any EU Taxonomy objective - see explanatory note in the left hand margin. The full criteria for fossil gas and nuclear energy economic activities that comply with the EU Taxonomy are laid down in Commission Delegated Regulation (EU) 2022/1214.

and among others have greenhouse gas emission levels corresponding to the best performance.



What is the minimum share of sustainable investments with an environmental objective that are not aligned with the EU Taxonomy?

Taxonomy-aligned investments are considered a sub-category of Sustainable Investments. If an investment is not Taxonomy-aligned since the activity is not yet covered under the EU Taxonomy or the positive contribution is not substantial enough to comply with the Taxonomy technical screening criteria, the investment can still be considered an environmentally Sustainable Investment provided it complies with all criteria. The Investment Manager does not commit to a minimum share of environmentally Sustainable Investments that are not aligned with the EU Taxonomy. The overall sustainable investment share may also include investments with an environmental objective in economic activities that do not qualify as environmentally sustainable under the EU Taxonomy, and while the Sub-Fund cannot commit to a minimum share of environmentally or socially sustainable investments, such investments may be freely allocated to within the Sub-Fund aggregated sustainable investment commitment disclosed (min. 50%).



are sustainable investments with an environmental objective that **do not take into account the criteria** for environmentally sustainable economic activities under the EU Taxonomy.



What is the minimum share of socially sustainable investments?

The Investment Manager defines Sustainable Investments based on internal research, which uses, among others, the UN Sustainable Development Goals (SDGs), as well as the objectives of the EU Taxonomy as reference frameworks. The Investment Manager does not commit to a minimum share of socially Sustainable Investments, as the SDGs contain environmental as well as social objectives. The overall sustainable investment share may also include investments with a social objective, and while the Sub-Fund cannot commit to a minimum share of environmentally or socially sustainable investments, such investments may be freely allocated to within the Sub-Fund aggregated sustainable investment commitment disclosed (min. 50%).



What investments are included under “#2 Other”, what is their purpose and are there any minimum environmental or social safeguards?

Under “#2 Other” investments into cash, Target Funds, or derivatives can be included. Derivatives might be used for efficient portfolio management (including risk hedging) and/or investment purposes, and Target Funds to benefit from a specific strategy. For those investments no environmental or social safeguards are applied.



Is a specific index designated as a reference benchmark to determine whether this financial product is aligned with the environmental and/or social characteristics that it promotes?

No reference benchmark has been designated for the purpose of attaining the environmental and/or social characteristics promoted by the Sub-Fund.

Reference benchmarks are indexes to measure whether the financial product attains the environmental or social characteristics that they promote.

- How is the reference benchmark continuously aligned with each of the environmental or social characteristics promoted by the financial product?

Not applicable

- How is the alignment of the investment strategy with the methodology of the index ensured on a continuous basis?

Not applicable

- How does the designated index differ from a relevant broad market index?
Not applicable
- Where can the methodology used for the calculation of the designated index be found?
Not applicable



Where can I find more product specific information online?

More product-specific information can be found on the website: <https://regulatory.allianzgi.com/SFDR>

Template pre-contractual disclosure for the financial products referred to in Article 8, paragraphs 1, 2 and 2a, of Regulation (EU) 2019/2088 and Article 6, first paragraph, of Regulation (EU) 2020/852

Product name:

Allianz German Equity

Legal entity identifier: 529900TEU4JD3HNC2746

Environmental and/or social characteristics

Sustainable investment means an investment in an economic activity that contributes to an environmental or social objective, provided that the investment does not significantly harm any environmental or social objective and that the investee companies follow good governance practices.

The EU Taxonomy is a classification system laid down in Regulation (EU) 2020/852, establishing a list of environmentally sustainable economic activities. That Regulation does not include a list of socially sustainable economic activities. Sustainable investments with an environmental objective might be aligned with the Taxonomy or not.

Does this financial product have a sustainable investment objective?	
Yes	No
<input type="checkbox"/> It will make a minimum of sustainable investments with an environmental objective: ___% <input type="checkbox"/> in economic activities that qualify as environmentally sustainable under the EU Taxonomy <input type="checkbox"/> in economic activities that do not qualify as environmentally sustainable under the EU Taxonomy	<input checked="" type="checkbox"/> It promotes Environmental/Social (E/S) characteristics and while it does not have as its objective a sustainable investment, it will have a minimum proportion of 15.00% of sustainable investments <input checked="" type="checkbox"/> with an environmental objective in economic activities that qualify as environmentally sustainable under the EU Taxonomy <input checked="" type="checkbox"/> with an environmental objective in economic activities that do not qualify as environmentally sustainable under the EU Taxonomy <input checked="" type="checkbox"/> with a social objective
<input type="checkbox"/> It will make a minimum of sustainable investments with a social objective ___%	<input type="checkbox"/> It promotes E/S characteristics, but will not make any sustainable investments



What environmental and/or social characteristics are promoted by this financial product?

Allianz German Equity (the "Sub-Fund") is managed according to the Sustainability Key Performance Indicator Strategy (Relative) ("KPI Strategy (Relative)") which addresses greenhouse gas (GHG) Intensity. The "Sustainability KPI" measures the GHG Intensity defined by the weighted average intensity of greenhouse gas emissions based on company's annual sales ("GHG Intensity").

GHG Intensity will be addressed by outperforming the Weighted Average GHG Intensity against its benchmark.

In addition, sustainable minimum exclusion criteria apply.

A reference benchmark has been designated for the purpose of attaining the environmental and/or social characteristics promoted by the Sub-Fund.

What sustainability indicators are used to measure the attainment of each of the environmental or social characteristics promoted by this financial product?

To measure the attainment of the environmental and/or social characteristics the following sustainability indicators are used and reported on, at the fiscal year end:

- The actual percentage of KPI coverage of the Sub-Fund's Portfolio (Portfolio in this respect does not comprise derivatives and instruments that are non-evaluated by nature (e. g., cash and deposits)).
- The actual weighted average GHG Intensity portfolio vs weighted average GHG Intensity of the benchmark.

Sustainability indicators measure how the environmental or social characteristics promoted by the financial product are attained.

- Confirmation that Principal adverse impacts (PAIs) of investment decisions on sustainability factors are considered through the application of exclusion criteria.

- **What are the objectives of the sustainable investments that the financial product partially intends to make and how does the sustainable investment contribute to such objectives?**

Sustainable investments contribute to environmental and/or social objectives, for which the Investment Manager uses as reference frameworks, among others, the UN Sustainable Development Goals (SDGs), as well as the objectives of the EU Taxonomy:

1. Climate Change Mitigation
2. Climate Change Adaptation
3. Sustainable Use and Protection of Water and Marine Resources
4. Transition to a Circular Economy
5. Pollution Prevention and Control
6. Protection and Restoration of Biodiversity and Ecosystems

The assessment of the positive contribution to the environmental or social objectives is based on a proprietary framework which combines quantitative elements with qualitative inputs from internal research. The methodology applies first a quantitative breakdown of a securities issuer into its business activities. The qualitative element of the framework is an assessment if business activities contribute positively to an environmental or a social objective.

To calculate the positive contribution on the Sub-Fund level the revenue share of each issuer attributable to business activities contributing to environmental and/or social objectives is considered provided the issuer is satisfying the Do No Significant Harm (“DNSH”) and Good Governance principles, and an asset-weighted aggregation is performed as a second step. Moreover, for certain types of securities, which finance specific projects contributing to environmental or social objectives the overall investment is considered to contribute to environmental and/or social objectives, but also for these a DNSH as well as a Good Governance check for issuers is performed.

- **How do the sustainable investments that the financial product partially intends to make, not cause significant harm to any environmental or social sustainable investment objective?**

In order to ensure that Sustainable Investments do not significantly harm any other environmental and/or social objective, the Investment Manager is leveraging the PAI indicators, whereby significance thresholds have been defined to identify significantly harmful issuers. Issuers not meeting the significance threshold can be engaged for a limited time period to remediate the adverse impact. Otherwise, if the issuer does not meet the defined significance thresholds twice subsequently or in case of a failed engagement, it does not pass the DNSH assessment. Investments in securities of issuers which do not pass the DNSH assessment are not counted as sustainable investments.

- *How have the indicators for adverse impacts on sustainability factors been taken into account?*

All mandatory PAI indicators are considered either as part of the application of the exclusion criteria or through thresholds on a sectorial or absolute basis. Significance thresholds have been defined and they refer to qualitative or quantitative criteria.

Recognizing the lack of data coverage for some of the PAI indicators equivalent data points are used to assess PAI indicators when applying the DNSH assessment, when relevant, for the following indicators for corporates: share of non-renewable energy consumption and production, activities negatively affecting biodiversity-sensitive areas, emissions to water, lack of processes and compliance mechanisms to monitor compliance with UNGC principles and OECD Guidelines for Multinational Enterprises; for sovereigns: GHG Intensity and investee countries subject to social violations. In case of securities which finance specific projects contributing to environmental or social objectives equivalent data at project level might be used to ensure that Sustainable Investments do not significantly harm any other environmental and/or social objective. The Investment Manager will strive to increase data coverage for PAI indicators with low data coverage by engaging with issuers and data providers. The Investment Manager will regularly evaluate whether the availability of data has increased sufficiently to potentially include assessment of such data in the investment process.

Principal adverse impacts are the most significant negative impacts of investment decisions on sustainability factors relating to environmental, social and employee matters, respect for human rights, anti-corruption and anti-bribery matters.

- *How are the sustainable investments aligned with the OECD Guidelines for Multinational Enterprises and the UN Guiding Principles on Business and Human Rights? Details:*

The Investment Manager's sustainable minimum exclusion list screens out companies based on their involvement in controversial practices against international norms. The core normative framework consists of the Principles of the UN Global Compact, the OECD Guidelines for Multinational Enterprises and the UN Guiding Principles for Business and Human Rights. Securities issued by companies having a severe violation of these frameworks will be restricted from the investment universe.

The EU Taxonomy sets out a "do not significant harm" principle by which Taxonomy-aligned investments should not significantly harm EU Taxonomy objectives and is accompanied by specific EU criteria.

The "do not significant harm" principle applies only to those investments underlying the financial product that take into account the EU criteria for environmentally sustainable economic activities. The investments underlying the remaining portion of this financial product do not take into account the EU criteria for environmentally sustainable economic activities.

Any other sustainable investments must also not significantly harm any environmental or social objectives.



Does this financial product consider principal adverse impacts on sustainability factors?

Yes

No

The Management Company has joined the Net Zero Asset Manager Initiative and considers PAI indicators through stewardship including engagement, both are relevant to mitigate potential adverse impact as a company.

Due to the commitment to the Net Zero Asset Manager Initiative, the Management Company aims to reduce greenhouse gas emissions in partnership with asset owner clients on decarbonisation goals, consistent with an ambition to reach net zero emission by 2050 or sooner across all assets under management. As part of this objective the Management Company will set an interim target for the proportion of assets to be managed in line with the attainment of net zero emissions by 2050 or sooner.

The Sub-Fund's Investment Manager addresses PAI indicators regarding greenhouse gas emission, biodiversity, water, waste as well as social and employee matters for corporate issuers, and, where relevant, the freedom house index is applied to investments in sovereigns. PAI indicators are considered within the Investment Manager's investment process through the means of exclusions as described in the "binding elements" section of the Sub-Fund.

The data coverage for the data required for the PAI indicators is heterogenous. The data coverage related to biodiversity, water and waste is low and the related PAI indicators are considered through exclusion of securities issued by companies having a severe violation / breach of principles and guidelines such as the Principles of the United Nations Global Compact, the OECD Guidelines for Multinational Enterprises, and the United Nations Guiding Principles for Business and Human Rights on the grounds of problematic practices around human rights, labour rights, environment, and corruption issues. Therefore, the Investment Manager will strive to increase data coverage for PAI indicators with low data coverage. The Investment Manager will regularly evaluate whether the availability of data has increased sufficiently to potentially include assessment of such data in the investment process.

Additionally, the Investment manager considers GHG related PAI indicators by outperforming the Weighted Average GHG Intensity against its benchmark. The following PAI indicators are considered:

Applicable to corporate issuers

- GHG Emissions
- Carbon footprint
- GHG Intensity of investee companies
- Exposure to companies active in the fossil fuel sector
- Activities negatively affecting biodiversity-sensitive areas
- Emissions to water
- Hazardous waste ratio
- Violation of UN Global compact principles

- Lack of processes and compliance mechanisms to monitor compliance with UN Global Compact principles
- Board gender diversity
- Exposure to controversial weapons

Applicable to sovereign and supranational issuers

- Investee countries subject to social violations

The information on the PAI indicators will be available in the end-year report of the Sub-Fund.



What investment strategy does this financial product follow?

The investment strategy guides investment decisions based on factors such as investment objectives and risk tolerance.

Allianz German Equity's investment objective is to invest in German Equity Markets in accordance with the Sustainability Key Performance Indicator Strategy (Relative) ("KPI Strategy (Relative)"). The Sub-Fund's strategy is to outperform the Weighted Average GHG Intensity against its benchmark. The outperformance is determined as the excess between the Sub-Fund's weighted average GHG Intensity and the Sub-Fund's benchmark Weighted Average GHG Intensity.

The weighted average GHG Intensity is the weighted average of the Sub-Fund's GHG Intensity (in tCO₂e per Millions of sales). Sales represent company's annual sales. This ratio of GHG normalized by Sales facilitates comparison between companies of different sizes. The ratio is in tCO₂e per Millions of sales. The metric allows comparing weighted average GHG Intensities of different portfolios to identify portfolios comprised of more GHG-efficient issuers in terms of the issuer's sales. The portfolio weights (and benchmark or universe weights) are rebased such that only issuers with GHG emissions data available are considered in the calculation. GHG represents a respective issuer's greenhouse gas emissions. To determine the GHG Intensity of a company issuer, GHG Intensity data from third party data providers will be used. The GHG intensity is analysed by the Investment Manager and is considered within the securities selection process in order to meet the Sub-Fund Investment objective.

The proportion of assets which do not have a GHG intensity assessment is expected to be low. Examples of instruments not having a GHG intensity assessment are cash and deposits, some Target Funds, and investments for which the GHG intensity is deemed to be not appropriate and/or data is not available.

The Sub-Fund's general investment approach (Sub-Fund's applicable General Asset Class Principles in combination with its individual investment restrictions) is described in the prospectus.

● What are the binding elements of the investment strategy used to select the investments to attain each of the environmental or social characteristics promoted by this financial product?

The binding elements are:

- Min. 80% KPI coverage of the Sub-Fund's Portfolio (Portfolio in this respect does not comprise derivatives and instruments that are non-evaluated by nature (e. g., cash and deposits)).
- Min. 20% outperformance of benchmark in terms of Weighted Average GHG Intensity.
- Application of the following sustainable minimum exclusion criteria for direct investments:
 - securities issued by companies having a severe violation / breach of principles and guidelines such as the Principles of the United Nations Global Compact, the OECD Guidelines for Multinational Enterprises, and the United Nations Guiding Principles for Business and Human Rights on the grounds of problematic practices around human rights, labour rights, environment, and corruption issues,
 - securities issued by companies involved in controversial weapons (anti-personnel mines, cluster munitions, chemical weapons, biological weapons, depleted uranium, white phosphorus, and nuclear weapons),
 - securities issued by companies that derive more than 10% of their revenues from weapons, military equipment, and services,
 - securities issued by companies that derive more than 10% of their revenue from thermal coal extraction,
 - securities issued by utility companies that generate more than 20% of their revenues from coal,
 - securities issued by companies involved in the production of tobacco, and securities issued by companies involved in the distribution of tobacco with more than 5% of their revenues.

Direct investments in sovereign issuers with an insufficient freedom house index score are excluded.

The sustainable minimum exclusion criteria are based on information from an external data provider and coded in pre- and post-trade compliance. The review is performed at least half yearly.

● **What is the committed minimum rate to reduce the scope of the investments considered prior to the application of that investment strategy?**

The Sub-Fund does not commit to reduce the scope of the investments by a certain minimum rate.

● **What is the policy to assess good governance practices of the investee companies?**

Good governance principles are considered by screening out companies based on their involvement in controversies around international norms corresponding to the four good governance practices: sound management structures, employee relations, remuneration of staff and tax compliance. Companies having a severe violation in either of those areas will not be investible. For certain cases, flagged issuers shall be on a watch list. These companies will appear on this watch list when the Investment Manager believes that engagement may lead to improvements or when the company is assessed to take remedial actions. Companies on the watch list remain investible unless the Investment Manager believes that the engagement or the remedial actions of the company does not lead to the desired remedy of the severe controversy.

In addition, the Sub-Fund's Investment Manager is committed to actively encourage open dialogues with investee companies on corporate governance, proxy voting and broader sustainability issues in advance of shareholder meetings (regularly for direct investments in shares). The Sub-Fund's Investment Manager's approach to proxy voting and company engagement is set out in the Management Company's Stewardship Statement.

Good governance practices include sound management structures, employee relations, remuneration of staff and tax compliance.



What is the asset allocation planned for this financial product?

Asset allocation describes the share of investments in specific assets.

Min. 80% of the Sub-Funds' assets (excluding cash, and derivatives) are used to meet the environmental or social characteristics promoted by this Sub-Fund. A low portion of the Sub-Fund might contain assets which do not promote environmental or social characteristics. Examples of such instruments are derivatives, cash and deposits, some Target Funds and investment with temporarily divergent or absent environmental, social, or good governance qualifications. Min. 15% of the Sub-Funds' assets will be invested in Sustainable Investments. The minimum percentage of investments that are aligned with the EU Taxonomy is 0.01%. The Sub-Fund's Investment Manager does not commit to a minimum share of environmentally Sustainable Investments that are not aligned with the EU Taxonomy. The Sub-Fund's Investment Manager does not commit to a minimum share of socially sustainable investments. While the Sub-Fund cannot commit to a minimum share of environmentally or socially sustainable investments, such investments may be freely allocated to within the Sub-Fund aggregated sustainable investment commitment disclosed (min. 15%).

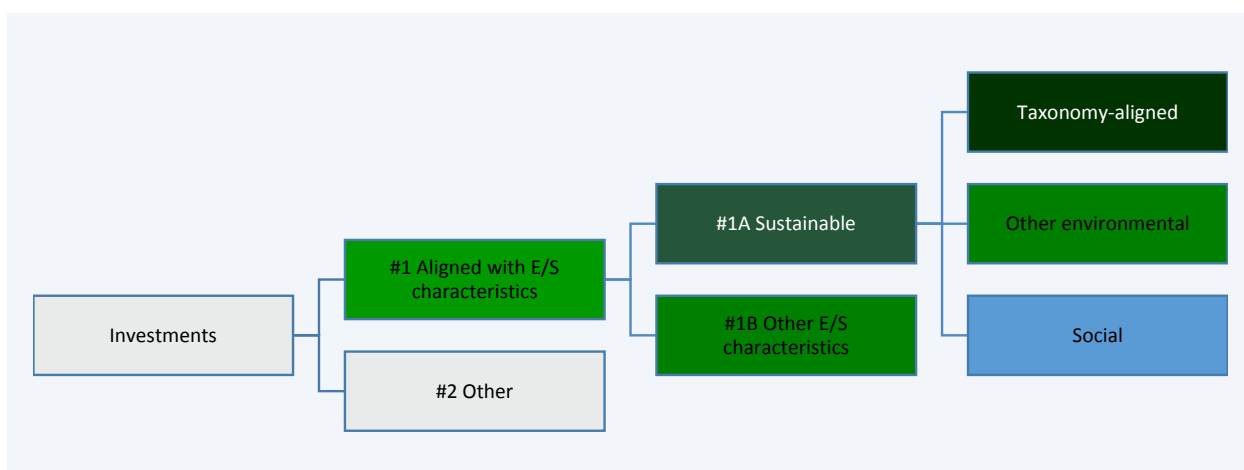

#1 Aligned with E/S characteristics includes the investments of the financial product used to attain the environmental or social characteristics promoted by the financial product.

#2 Other includes the remaining investments of the financial product which are neither aligned with the environmental or social characteristics, nor are qualified as sustainable investments.

The category **#1 Aligned with E/S characteristics** covers:

- The sub-category **#1A Sustainable** covers sustainable investments with environmental or social objectives.
- The sub-category **#1B Other E/S characteristics** covers investments aligned with the environmental or social characteristics that do not qualify as sustainable investments.

- How does the use of derivatives attain the environmental or social characteristics promoted by the financial product?

Not applicable



To what minimum extent are sustainable investments with an environmental objective aligned with the EU Taxonomy?

The Taxonomy-aligned investments include debt and/or equity in environmentally sustainable economic activities aligned with the EU-Taxonomy. The minimum percentage of investments that are aligned with the EU Taxonomy is 0.01%. Taxonomy-aligned data is provided by an external data provider. The Investment Manager has assessed the quality of such data. The data will not be subject to an assurance provided by auditors or a review by third parties. The data will not reflect any data in government bonds. As of today, there is no recognized methodology available to determine the proportion of Taxonomy-aligned activities when investing in government bonds.

Taxonomy-aligned activities in this disclosure are based on share of turnover. Pre-contractual figures use turnover as its financial metric as a default in line with the regulatory requirements and based on the fact that complete, verifiable or up-to date data for CAPEX and/or OPEX as financial metric is even less available.

Taxonomy-aligned data is only in rare cases data reported by companies in accordance with the EU Taxonomy. The data provider has derived Taxonomy-aligned data from other available equivalent public data.

- Does the financial product invest in fossil gas and/or nuclear energy related activities that comply with the EU Taxonomy ¹?

Yes:
 In fossil gas In nuclear energy

No

The Sub-Fund does not pursue any investments in fossil gas and/or nuclear energy related activities that comply with the EU Taxonomy. Nevertheless, as result of this investment strategy, investments may occur in corporates which are also active in these activities. Further information will be provided as part of the annual reporting, if relevant.

The two graphs below show in green the minimum percentage of investments that are aligned with the EU Taxonomy. As there is no appropriate methodology to determine the Taxonomy-alignment of sovereign bonds*, the first graph shows the Taxonomy-alignment in relation to all the investments of the financial product including sovereign bonds, while the second graph shows the Taxonomy-alignment only in relation to the investments of the financial product other than sovereign bonds.

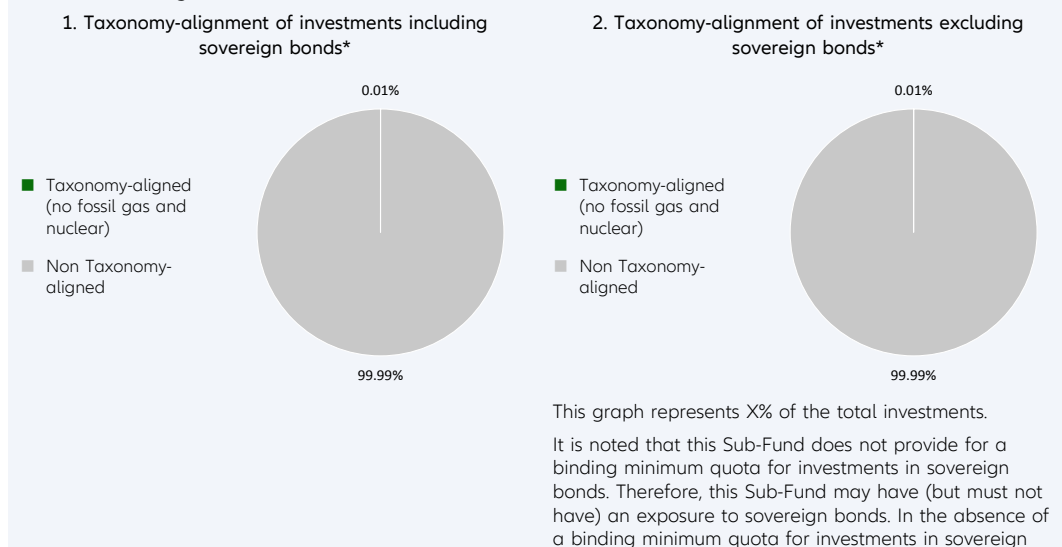

Taxonomy-aligned activities are expressed as a share of:
 - **turnover** reflecting the share of revenue from green activities of investee companies
 - **capital expenditure (CapEx)** showing the green investments made by investee companies, e.g. for a transition to a green economy.
 - **operational expenditure (OpEx)** reflecting green operational activities of investee companies.

¹ Fossil gas and/or nuclear related activities will only comply with the EU Taxonomy where they contribute to limiting climate change ("climate change mitigation") and do not significantly harm any EU Taxonomy objective - see explanatory note in the left hand margin. The full criteria for fossil gas and nuclear energy economic activities that comply with the EU Taxonomy are laid down in Commission Delegated Regulation (EU) 2022/1214.

bonds, this graph does not generate any additional added value compared to the left-hand graph.

* For the purpose of these graphs, 'sovereign bonds' consist of all sovereign exposures

Enabling activities directly enable other activities to make a substantial contribution to an environmental objective.

Transitional activities are activities for which low-carbon alternatives are not yet available and among others have greenhouse gas emission levels corresponding to the best performance.

● **What is the minimum share of investments in transitional and enabling activities?**

The Sub-Fund's Investment Manager does not commit to a split of minimum taxonomy alignment into transitional, enabling activities and own performance.



What is the minimum share of sustainable investments with an environmental objective that are not aligned with the EU Taxonomy?

Taxonomy-aligned investments are considered a sub-category of Sustainable Investments. If an investment is not Taxonomy-aligned since the activity is not yet covered under the EU Taxonomy or the positive contribution is not substantial enough to comply with the Taxonomy technical screening criteria, the investment can still be considered an environmentally Sustainable Investment provided it complies with all criteria. The Investment Manager does not commit to a minimum share of environmentally Sustainable Investments that are not aligned with the EU Taxonomy. The overall sustainable investment share may also include investments with an environmental objective in economic activities that do not qualify as environmentally sustainable under the EU Taxonomy, and while the Sub-Fund cannot commit to a minimum share of environmentally or socially sustainable investments, such investments may be freely allocated to within the Sub-Fund aggregated sustainable investment commitment disclosed (min. 15%).



are sustainable investments with an environmental objective that **do not take into account the criteria** for environmentally sustainable economic activities under the EU Taxonomy.



What is the minimum share of socially sustainable investments?

The Investment Manager defines Sustainable Investments based on internal research, which uses, among others, the UN Sustainable Development Goals (SDGs), as well as the objectives of the EU Taxonomy as reference frameworks. The Investment Manager does not commit to a minimum share of socially Sustainable Investments, as the SDGs contain environmental as well as social objectives. The overall sustainable investment share may also include investments with a social objective, and while the Sub-Fund cannot commit to a minimum share of environmentally or socially sustainable investments, such investments may be freely allocated to within the Sub-Fund aggregated sustainable investment commitment disclosed (min. 15%).



What investments are included under “#2 Other”, what is their purpose and are there any minimum environmental or social safeguards?

Under “#2 Other” investments into cash, Target Funds, or derivatives can be included. Derivatives might be used for efficient portfolio management (including risk hedging) and/or investment purposes, and Target Funds to benefit from a specific strategy. For those investments no environmental or social safeguards are applied.



Is a specific index designated as a reference benchmark to determine whether this financial product is aligned with the environmental and/or social characteristics that it promotes?

Yes, the Sub-Fund has assigned the DAX as a benchmark. This benchmark is a market index. The Sub-Fund will promote environmental and social characteristics by outperforming the benchmark's Weighted Average GHG Intensity

Reference benchmarks are indexes to measure whether the financial product attains the environmental or social characteristics that they promote.

- **How is the reference benchmark continuously aligned with each of the environmental or social characteristics promoted by the financial product?**

The benchmark is a market index and does not incorporate environmental or social characteristics for index construction.

- **How is the alignment of the investment strategy with the methodology of the index ensured on a continuous basis?**

The benchmark is not continuously aligned as it does not incorporate environmental or social characteristics for index construction.

- **How does the designated index differ from a relevant broad market index?**

The benchmark is a broad market index.

- **Where can the methodology used for the calculation of the designated index be found?**

Details of the Benchmark's methodology may be found at <https://qontigo.com/index/dax/>



Where can I find more product specific information online?

More product-specific information can be found on the website: <https://regulatory.allianzgi.com/SFDR>

Template pre-contractual disclosure for the financial products referred to in Article 8, paragraphs 1, 2 and 2a, of Regulation (EU) 2019/2088 and Article 6, first paragraph, of Regulation (EU) 2020/852

Product name:

Allianz Global Artificial Intelligence

Legal entity identifier: 5299007Y9R7L3FEF1M54

Environmental and/or social characteristics

Sustainable investment means an investment in an economic activity that contributes to an environmental or social objective, provided that the investment does not significantly harm any environmental or social objective and that the investee companies follow good governance practices.

The **EU Taxonomy** is a classification system laid down in Regulation (EU) 2020/852, establishing a list of **environmentally sustainable economic activities**. That Regulation does not include a list of socially sustainable economic activities. Sustainable investments with an environmental objective might be aligned with the Taxonomy or not.

Does this financial product have a sustainable investment objective?	
<input checked="" type="radio"/> <input checked="" type="radio"/> Yes	<input type="radio"/> <input checked="" type="radio"/> No
<input type="checkbox"/> It will make a minimum of sustainable investments with an environmental objective: ___% <ul style="list-style-type: none"> <input type="checkbox"/> in economic activities that qualify as environmentally sustainable under the EU Taxonomy <input type="checkbox"/> in economic activities that do not qualify as environmentally sustainable under the EU Taxonomy 	<input checked="" type="checkbox"/> It promotes Environmental/Social (E/S) characteristics and while it does not have as its objective a sustainable investment, it will have a minimum proportion of 10.00% of sustainable investments <ul style="list-style-type: none"> <input checked="" type="checkbox"/> with an environmental objective in economic activities that qualify as environmentally sustainable under the EU Taxonomy <input checked="" type="checkbox"/> with an environmental objective in economic activities that do not qualify as environmentally sustainable under the EU Taxonomy <input checked="" type="checkbox"/> with a social objective
<input type="checkbox"/> It will make a minimum of sustainable investments with a social objective ___%	<input type="checkbox"/> It promotes E/S characteristics, but will not make any sustainable investments



What environmental and/or social characteristics are promoted by this financial product?

Allianz Global Artificial Intelligence (the "Sub-Fund") is managed according to the Sustainability Key Performance Indicator Strategy (Relative) ("KPI Strategy (Relative)") which addresses greenhouse gas (GHG) Intensity. The "Sustainability KPI" measures the GHG Intensity defined by the weighted average intensity of greenhouse gas emissions based on company's annual sales ("GHG Intensity").

GHG Intensity will be addressed by outperforming the Weighted Average GHG Intensity against its benchmark.

In addition, sustainable minimum exclusion criteria apply.

A reference benchmark has been designated for the purpose of attaining the environmental and/or social characteristics promoted by the Sub-Fund.

● What sustainability indicators are used to measure the attainment of each of the environmental or social characteristics promoted by this financial product?

To measure the attainment of the environmental and/or social characteristics the following sustainability indicators are used and reported on, at the fiscal year end:

- The actual percentage of KPI coverage of the Sub-Fund's Portfolio (Portfolio in this respect does not comprise derivatives and instruments that are non-evaluated by nature (e. g., cash and deposits)).
- The actual weighted average GHG Intensity portfolio vs weighted average GHG Intensity of the benchmark.

Sustainability indicators measure how the environmental or social characteristics promoted by the financial product are attained.

- Confirmation that Principal adverse impacts (PAIs) of investment decisions on sustainability factors are considered through the application of exclusion criteria.

- **What are the objectives of the sustainable investments that the financial product partially intends to make and how does the sustainable investment contribute to such objectives?**

Sustainable investments contribute to environmental and/or social objectives, for which the Investment Manager uses as reference frameworks, among others, the UN Sustainable Development Goals (SDGs), as well as the objectives of the EU Taxonomy:

1. Climate Change Mitigation
2. Climate Change Adaptation
3. Sustainable Use and Protection of Water and Marine Resources
4. Transition to a Circular Economy
5. Pollution Prevention and Control
6. Protection and Restoration of Biodiversity and Ecosystems

The assessment of the positive contribution to the environmental or social objectives is based on a proprietary framework which combines quantitative elements with qualitative inputs from internal research. The methodology applies first a quantitative breakdown of a securities issuer into its business activities. The qualitative element of the framework is an assessment if business activities contribute positively to an environmental or a social objective.

To calculate the positive contribution on the Sub-Fund level the revenue share of each issuer attributable to business activities contributing to environmental and/or social objectives is considered provided the issuer is satisfying the Do No Significant Harm (“DNSH”) and Good Governance principles, and an asset-weighted aggregation is performed as a second step. Moreover, for certain types of securities, which finance specific projects contributing to environmental or social objectives the overall investment is considered to contribute to environmental and/or social objectives, but also for these a DNSH as well as a Good Governance check for issuers is performed.

- **How do the sustainable investments that the financial product partially intends to make, not cause significant harm to any environmental or social sustainable investment objective?**

In order to ensure that Sustainable Investments do not significantly harm any other environmental and/or social objective, the Investment Manager is leveraging the PAI indicators, whereby significance thresholds have been defined to identify significantly harmful issuers. Issuers not meeting the significance threshold can be engaged for a limited time period to remediate the adverse impact. Otherwise, if the issuer does not meet the defined significance thresholds twice subsequently or in case of a failed engagement, it does not pass the DNSH assessment. Investments in securities of issuers which do not pass the DNSH assessment are not counted as sustainable investments.

- *How have the indicators for adverse impacts on sustainability factors been taken into account?*

All mandatory PAI indicators are considered either as part of the application of the exclusion criteria or through thresholds on a sectorial or absolute basis. Significance thresholds have been defined and they refer to qualitative or quantitative criteria.

Recognizing the lack of data coverage for some of the PAI indicators equivalent data points are used to assess PAI indicators when applying the DNSH assessment, when relevant, for the following indicators for corporates: share of non-renewable energy consumption and production, activities negatively affecting biodiversity-sensitive areas, emissions to water, lack of processes and compliance mechanisms to monitor compliance with UNGC principles and OECD Guidelines for Multinational Enterprises; for sovereigns: GHG Intensity and investee countries subject to social violations. In case of securities which finance specific projects contributing to environmental or social objectives equivalent data at project level might be used to ensure that Sustainable Investments do not significantly harm any other environmental and/or social objective. The Investment Manager will strive to increase data coverage for PAI indicators with low data coverage by engaging with issuers and data providers. The Investment Manager will regularly evaluate whether the availability of data has increased sufficiently to potentially include assessment of such data in the investment process.

Principal adverse impacts are the most significant negative impacts of investment decisions on sustainability factors relating to environmental, social and employee matters, respect for human rights, anti-corruption and anti-bribery matters.

- *How are the sustainable investments aligned with the OECD Guidelines for Multinational Enterprises and the UN Guiding Principles on Business and Human Rights? Details:*

The Investment Manager's sustainable minimum exclusion list screens out companies based on their involvement in controversial practices against international norms. The core normative framework consists of the Principles of the UN Global Compact, the OECD Guidelines for Multinational Enterprises and the UN Guiding Principles for Business and Human Rights. Securities issued by companies having a severe violation of these frameworks will be restricted from the investment universe.

The EU Taxonomy sets out a "do not significant harm" principle by which Taxonomy-aligned investments should not significantly harm EU Taxonomy objectives and is accompanied by specific EU criteria.

The "do not significant harm" principle applies only to those investments underlying the financial product that take into account the EU criteria for environmentally sustainable economic activities. The investments underlying the remaining portion of this financial product do not take into account the EU criteria for environmentally sustainable economic activities.

Any other sustainable investments must also not significantly harm any environmental or social objectives.



Does this financial product consider principal adverse impacts on sustainability factors?

Yes

No

The Management Company has joined the Net Zero Asset Manager Initiative and considers PAI indicators through stewardship including engagement, both are relevant to mitigate potential adverse impact as a company.

Due to the commitment to the Net Zero Asset Manager Initiative, the Management Company aims to reduce greenhouse gas emissions in partnership with asset owner clients on decarbonisation goals, consistent with an ambition to reach net zero emission by 2050 or sooner across all assets under management. As part of this objective the Management Company will set an interim target for the proportion of assets to be managed in line with the attainment of net zero emissions by 2050 or sooner.

The Sub-Fund's Investment Manager addresses PAI indicators regarding greenhouse gas emission, biodiversity, water, waste as well as social and employee matters for corporate issuers, and, where relevant, the freedom house index is applied to investments in sovereigns. PAI indicators are considered within the Investment Manager's investment process through the means of exclusions as described in the "binding elements" section of the Sub-Fund.

The data coverage for the data required for the PAI indicators is heterogenous. The data coverage related to biodiversity, water and waste is low and the related PAI indicators are considered through exclusion of securities issued by companies having a severe violation / breach of principles and guidelines such as the Principles of the United Nations Global Compact, the OECD Guidelines for Multinational Enterprises, and the United Nations Guiding Principles for Business and Human Rights on the grounds of problematic practices around human rights, labour rights, environment, and corruption issues. Therefore, the Investment Manager will strive to increase data coverage for PAI indicators with low data coverage. The Investment Manager will regularly evaluate whether the availability of data has increased sufficiently to potentially include assessment of such data in the investment process.

Additionally, the Investment manager considers GHG related PAI indicators by outperforming the Weighted Average GHG Intensity against its benchmark.

The following PAI indicators are considered:

Applicable to corporate issuers

- GHG Emissions
- Carbon footprint
- GHG Intensity of investee companies
- Exposure to companies active in the fossil fuel sector
- Activities negatively affecting biodiversity-sensitive areas
- Emissions to water
- Hazardous waste ratio

- Violation of UN Global compact principles
- Lack of processes and compliance mechanisms to monitor compliance with UN Global Compact principles
- Board gender diversity
- Exposure to controversial weapons

Applicable to sovereign and supranational issuers

- Investee countries subject to social violations

The information on the PAI indicators will be available in the end-year report of the Sub-Fund.



The investment strategy guides investment decisions based on factors such as investment objectives and risk tolerance.

What investment strategy does this financial product follow?

Allianz Global Artificial Intelligence's investment objective is to invest in the global equity markets with a focus on the evolution of artificial intelligence in accordance with the Sustainability Key Performance Indicator Strategy (Relative) ("KPI Strategy (Relative)").

The Sub-Fund's strategy is to outperform the Weighted Average GHG Intensity against its benchmark. The outperformance is determined as the excess between the Sub-Fund's weighted average GHG Intensity and the Sub-Fund's benchmark Weighted Average GHG Intensity.

The weighted average GHG Intensity is the weighted average of the Sub-Fund's GHG Intensity (in tCO₂e per Millions of sales). Sales represent company's annual sales. This ratio of GHG normalized by Sales facilitates comparison between companies of different sizes. The ratio is in tCO₂e per Millions of sales. The metric allows comparing weighted average GHG Intensities of different portfolios to identify portfolios comprised of more GHG-efficient issuers in terms of the issuer's sales. The portfolio weights (and benchmark or universe weights) are rebased such that only issuers with GHG emissions data available are considered in the calculation. GHG represents a respective issuer's greenhouse gas emissions. To determine the GHG Intensity of a company issuer, GHG Intensity data from third party data providers will be used. The GHG intensity is analysed by the Investment Manager and is considered within the securities selection process in order to meet the Sub-Fund Investment objective.

The proportion of assets which do not have a GHG intensity assessment is expected to be low. Examples of instruments not having a GHG intensity assessment are cash and deposits, some Target Funds, and investments for which the GHG intensity is deemed to be not appropriate and/or data is not available.

The Sub-Fund's general investment approach (Sub-Fund's applicable General Asset Class Principles in combination with its individual investment restrictions) is described in the prospectus.

● What are the binding elements of the investment strategy used to select the investments to attain each of the environmental or social characteristics promoted by this financial product?

The binding elements are:

- Min. 80% KPI coverage of the Sub-Fund's Portfolio (Portfolio in this respect does not comprise derivatives and instruments that are non-evaluated by nature (e. g., cash and deposits)).
- Min. 20% outperformance of benchmark in terms of Weighted Average GHG Intensity.
- Application of the following sustainable minimum exclusion criteria for direct investments:
 - securities issued by companies having a severe violation / breach of principles and guidelines such as the Principles of the United Nations Global Compact, the OECD Guidelines for Multinational Enterprises, and the United Nations Guiding Principles for Business and Human Rights on the grounds of problematic practices around human rights, labour rights, environment, and corruption issues,
 - securities issued by companies involved in controversial weapons (anti-personnel mines, cluster munitions, chemical weapons, biological weapons, depleted uranium, white phosphorus, and nuclear weapons),
 - securities issued by companies that derive more than 10% of their revenues from weapons, military equipment, and services,
 - securities issued by companies that derive more than 10% of their revenue from thermal coal extraction,
 - securities issued by utility companies that generate more than 20% of their revenues from coal,

- securities issued by companies involved in the production of tobacco, and securities issued by companies involved in the distribution of tobacco with more than 5% of their revenues.

Direct investments in sovereign issuers with an insufficient freedom house index score are excluded.

The sustainable minimum exclusion criteria are based on information from an external data provider and coded in pre- and post-trade compliance. The review is performed at least half yearly.

- **What is the committed minimum rate to reduce the scope of the investments considered prior to the application of that investment strategy?**

The Sub-Fund does not commit to reduce the scope of the investments by a certain minimum rate.

- **What is the policy to assess good governance practices of the investee companies?**

Good governance principles are considered by screening out companies based on their involvement in controversies around international norms corresponding to the four good governance practices: sound management structures, employee relations, remuneration of staff and tax compliance. Companies having a severe violation in either of those areas will not be investible. For certain cases, flagged issuers shall be on a watch list. These companies will appear on this watch list when the Investment Manager believes that engagement may lead to improvements or when the company is assessed to take remedial actions. Companies on the watch list remain investible unless the Investment Manager believes that the engagement or the remedial actions of the company does not lead to the desired remedy of the severe controversy.

In addition, the Sub-Fund's Investment Manager is committed to actively encourage open dialogues with investee companies on corporate governance, proxy voting and broader sustainability issues in advance of shareholder meetings (regularly for direct investments in shares). The Sub-Fund's Investment Manager's approach to proxy voting and company engagement is set out in the Management Company's Stewardship Statement.

Good governance practices include sound management structures, employee relations, remuneration of staff and tax compliance.



What is the asset allocation planned for this financial product?

Asset allocation describes the share of investments in specific assets.

Min. 80% of the Sub-Funds' assets (excluding cash, and derivatives) are used to meet the environmental or social characteristics promoted by this Sub-Fund. A low portion of the Sub-Fund might contain assets which do not promote environmental or social characteristics. Examples of such instruments are derivatives, cash and deposits, some Target Funds and investment with temporarily divergent or absent environmental, social, or good governance qualifications. Min. 10% of the Sub-Funds' assets will be invested in Sustainable Investments. The minimum percentage of investments that are aligned with the EU Taxonomy is 0.01%. The Sub-Fund's Investment Manager does not commit to a minimum share of environmentally Sustainable Investments that are not aligned with the EU Taxonomy. The Sub-Fund's Investment Manager does not commit to a minimum share of socially sustainable investments. While the Sub-Fund cannot commit to a minimum share of environmentally or socially sustainable investments, such investments may be freely allocated to within the Sub-Fund aggregated sustainable investment commitment disclosed (min. 10%).

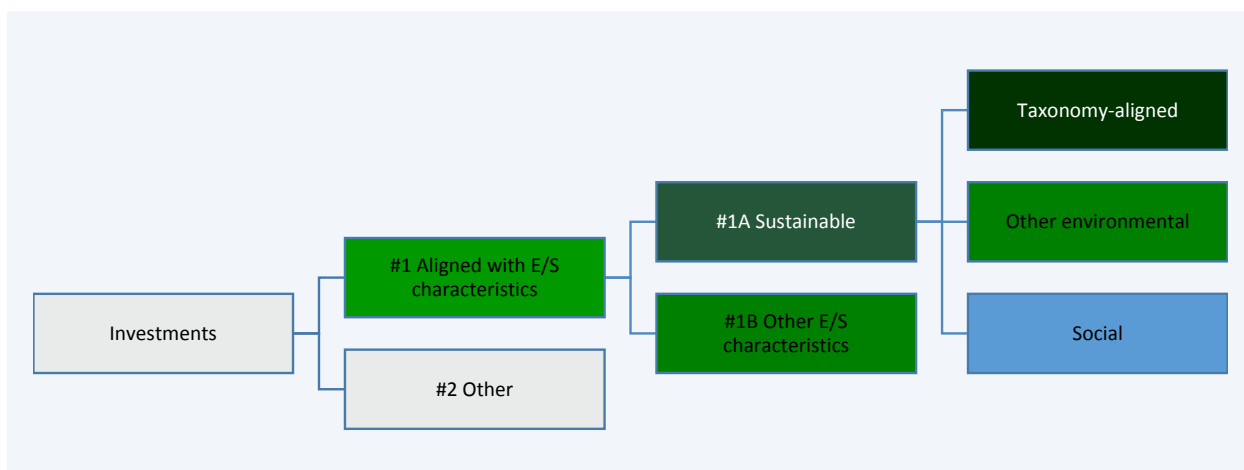

#1 Aligned with E/S characteristics includes the investments of the financial product used to attain the environmental or social characteristics promoted by the financial product.

#2 Other includes the remaining investments of the financial product which are neither aligned with the environmental or social characteristics, nor are qualified as sustainable investments.

The category **#1 Aligned with E/S characteristics** covers:

- The sub-category **#1A Sustainable** covers sustainable investments with environmental or social objectives.
- The sub-category **#1B Other E/S characteristics** covers investments aligned with the environmental or social characteristics that do not qualify as sustainable investments.

- **How does the use of derivatives attain the environmental or social characteristics promoted by the financial product?**

Not applicable



To what minimum extent are sustainable investments with an environmental objective aligned with the EU Taxonomy?

The Taxonomy-aligned investments include debt and/or equity in environmentally sustainable economic activities aligned with the EU-Taxonomy. The minimum percentage of investments that are aligned with the EU Taxonomy is 0.01%. Taxonomy-aligned data is provided by an external data provider. The Investment Manager has assessed the quality of such data. The data will not be subject to an assurance provided by auditors or a review by third parties. The data will not reflect any data in government bonds. As of today, there is no recognized methodology available to determine the proportion of Taxonomy-aligned activities when investing in government bonds.

Taxonomy-aligned activities in this disclosure are based on share of turnover. Pre-contractual figures use turnover as its financial metric as a default in line with the regulatory requirements and based on the fact that complete, verifiable or up-to date data for CAPEX and/or OPEX as financial metric is even less available.

Taxonomy-aligned data is only in rare cases data reported by companies in accordance with the EU Taxonomy. The data provider has derived Taxonomy-aligned data from other available equivalent public data.

- **Does the financial product invest in fossil gas and/or nuclear energy related activities that comply with the EU Taxonomy¹?**

Yes:

In fossil gas In nuclear energy

No

The Sub-Fund does not pursue any investments in fossil gas and/or nuclear energy related activities that comply with the EU Taxonomy. Nevertheless, as result of this investment strategy, investments may occur in corporates which are also active in these activities. Further information will be provided as part of the annual reporting, if relevant.

Taxonomy-aligned activities are expressed as a share of:

- **turnover** reflecting the share of revenue from green activities of investee companies
- **capital expenditure** (CapEx) showing the green investments made by investee companies, e.g. for a transition to a green economy.
- **operational expenditure** (OpEx) reflecting green operational activities of investee companies.

¹ Fossil gas and/or nuclear related activities will only comply with the EU Taxonomy where they contribute to limiting climate change ("climate change mitigation") and do not significantly harm any EU Taxonomy objective - see explanatory note in the left hand margin. The full criteria for fossil gas and nuclear energy economic activities that comply with the EU Taxonomy are laid down in Commission Delegated Regulation (EU) 2022/1214.

The two graphs below show in green the minimum percentage of investments that are aligned with the EU Taxonomy. As there is no appropriate methodology to determine the Taxonomy-alignment of sovereign bonds*, the first graph shows the Taxonomy-alignment in relation to all the investments of the financial product including sovereign bonds, while the second graph shows the Taxonomy-alignment only in relation to the investments of the financial product other than sovereign bonds.

1. Taxonomy-alignment of investments including sovereign bonds*

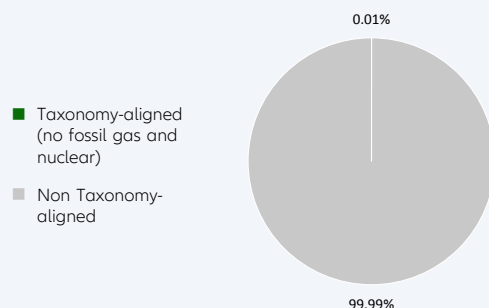

2. Taxonomy-alignment of investments excluding sovereign bonds*

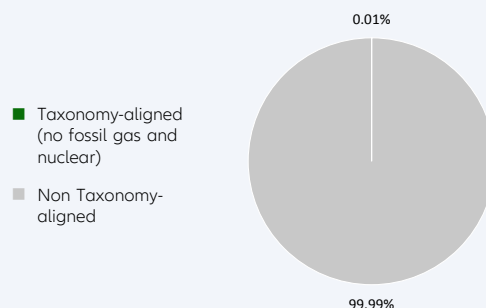

This graph represents X% of the total investments.

It is noted that this Sub-Fund does not provide for a binding minimum quota for investments in sovereign bonds. Therefore, this Sub-Fund may have (but must not have) an exposure to sovereign bonds. In the absence of a binding minimum quota for investments in sovereign bonds, this graph does not generate any additional added value compared to the left-hand graph.

* For the purpose of these graphs, 'sovereign bonds' consist of all sovereign exposures

Enabling activities directly enable other activities to make a substantial contribution to an environmental objective.

Transitional activities are activities for which low-carbon alternatives are not yet available and among others have greenhouse gas emission levels corresponding to the best performance.

● **What is the minimum share of investments in transitional and enabling activities?**

The Sub-Fund's Investment Manager does not commit to a split of minimum taxonomy alignment into transitional, enabling activities and own performance.



What is the minimum share of sustainable investments with an environmental objective that are not aligned with the EU Taxonomy?

Taxonomy-aligned investments are considered a sub-category of Sustainable Investments. If an investment is not Taxonomy-aligned since the activity is not yet covered under the EU Taxonomy or the positive contribution is not substantial enough to comply with the Taxonomy technical screening criteria, the investment can still be considered an environmentally Sustainable Investment provided it complies with all criteria. The Investment Manager does not commit to a minimum share of environmentally Sustainable Investments that are not aligned with the EU Taxonomy. The overall sustainable investment share may also include investments with an environmental objective in economic activities that do not qualify as environmentally sustainable under the EU Taxonomy, and while the Sub-Fund cannot commit to a minimum share of environmentally or socially sustainable investments, such investments may be freely allocated to within the Sub-Fund aggregated sustainable investment commitment disclosed (min. 10%).



are sustainable investments with an environmental objective that **do not take into account the criteria** for environmentally sustainable economic activities under the EU Taxonomy.



What is the minimum share of socially sustainable investments?

The Investment Manager defines Sustainable Investments based on internal research, which uses, among others, the UN Sustainable Development Goals (SDGs), as well as the objectives of the EU Taxonomy as reference frameworks. The Investment Manager does not commit to a minimum share of socially Sustainable Investments, as the SDGs contain environmental as well as social objectives. The overall sustainable investment share may also include investments with a social objective, and while the Sub-Fund cannot commit to a minimum share of environmentally or socially sustainable investments, such investments may be freely allocated to within the Sub-Fund aggregated sustainable investment commitment disclosed (min 10%).



What investments are included under “#2 Other”, what is their purpose and are there any minimum environmental or social safeguards?

Under “#2 Other” investments into cash, Target Funds, or derivatives can be included. Derivatives might be used for efficient portfolio management (including risk hedging) and/or investment purposes, and Target Funds to benefit from a specific strategy. For those investments no environmental or social safeguards are applied.



Is a specific index designated as a reference benchmark to determine whether this financial product is aligned with the environmental and/or social characteristics that it promotes?

Yes, the Sub-Fund has assigned a composite benchmark 50% MSCI AC World (ACWI) Total Return Net + 50% MSCI World Information Technology Total Return Net. This composite benchmark is using market indices. The Sub-Fund will promote environmental and social characteristics by outperforming the benchmark's Weighted Average GHG Intensity

- **How is the reference benchmark continuously aligned with each of the environmental or social characteristics promoted by the financial product?**

The composite benchmark uses market indices and does not incorporate environmental or social characteristics for index construction.

- **How is the alignment of the investment strategy with the methodology of the index ensured on a continuous basis?**

The benchmark is not continuously aligned as it does not incorporate environmental or social characteristics for index construction.

- **How does the designated index differ from a relevant broad market index?**

The composite benchmark uses broad market indices.

- **Where can the methodology used for the calculation of the designated index be found?**

Details of the Benchmark's methodology may be found at <https://www.msci.com/documents/10199/a71b65b5-d0ea-4b5c-a709-24b1213bc3c5> and at <https://www.msci.com/documents/10199/69aaf9fd-d91d-4505-a877-4b1ad70ee855> or at www.msci.com



Where can I find more product specific information online?

More product-specific information can be found on the website: <https://regulatory.allianzgi.com/SFDR>

Reference benchmarks are indexes to measure whether the financial product attains the environmental or social characteristics that they promote.

Template pre-contractual disclosure for the financial products referred to in Article 8, paragraphs 1, 2 and 2a, of Regulation (EU) 2019/2088 and Article 6, first paragraph, of Regulation (EU) 2020/852

Product name:

Allianz Global Capital Plus

Legal entity identifier: 529900DH9JBAV7A2IO06

Environmental and/or social characteristics

Sustainable investment means an investment in an economic activity that contributes to an environmental or social objective, provided that the investment does not significantly harm any environmental or social objective and that the investee companies follow good governance practices.

The **EU Taxonomy** is a classification system laid down in Regulation (EU) 2020/852, establishing a list of **environmentally sustainable economic activities**. That Regulation does not include a list of socially sustainable economic activities. Sustainable investments with an environmental objective might be aligned with the Taxonomy or not.

Does this financial product have a sustainable investment objective?	
Yes	No
<input type="checkbox"/> It will make a minimum of sustainable investments with an environmental objective: ___% <ul style="list-style-type: none"> <input type="checkbox"/> in economic activities that qualify as environmentally sustainable under the EU Taxonomy <input type="checkbox"/> in economic activities that do not qualify as environmentally sustainable under the EU Taxonomy 	<input checked="" type="checkbox"/> It promotes Environmental/Social (E/S) characteristics and while it does not have as its objective a sustainable investment, it will have a minimum proportion of 1.50% of sustainable investments <ul style="list-style-type: none"> <input checked="" type="checkbox"/> with an environmental objective in economic activities that qualify as environmentally sustainable under the EU Taxonomy <input checked="" type="checkbox"/> with an environmental objective in economic activities that do not qualify as environmentally sustainable under the EU Taxonomy <input checked="" type="checkbox"/> with a social objective
<input type="checkbox"/> It will make a minimum of sustainable investments with a social objective ___%	<input type="checkbox"/> It promotes E/S characteristics, but will not make any sustainable investments



What environmental and/or social characteristics are promoted by this financial product?

Allianz Global Capital Plus (the “Sub-Fund”) promotes a broad range of environmental and/or social characteristics. The Sub-Fund invests at least 90% of its assets following the “Multi Asset Sustainability Strategy” which includes, but is not limited to, various sustainability strategies of the management company and/or, invests in Green Bonds and/or Social Bonds, and/or Sustainability Bonds and/or SFDR Article 8 & 9 Target Funds (“SFDR Target Funds”).

Depending on the sustainability strategy selected by the Investment Manager the promoted environmental and/or social characteristics could comprise environmental, social, human rights, governance, business behaviour factors or investments in companies providing solutions that create positive environmental and social outcomes.

In addition, sustainable minimum exclusion criteria apply.

No reference benchmark has been designated for the purpose of attaining the environmental and/or social characteristics promoted by the Sub-Fund.

- **What sustainability indicators are used to measure the attainment of each of the environmental or social characteristics promoted by this financial product?**

As part of the Multi Asset Sustainability Strategy the Investment Manager allocates at least 90% of Fund’s assets in various sustainability approaches.

Sustainability indicators measure how the environmental or social characteristics promoted by the financial product are attained.

To measure the attainment of the environmental and/or social characteristics the following sustainability indicators are used and reported on, at the fiscal year end:

- The actual percentage of the Sub-Fund's assets invested in Green Bonds, and/or Social Bonds, and/or Sustainability Bonds and/or in SFDR Target Funds and/or in Equities and/or Debt Securities in accordance with the Multi Asset Sustainability Strategy.
- In case the Investment Manager decides to directly invest in Debt or Equity Securities as part of the Multi Asset Sustainability Strategy the adherence to the respective binding element will be reported.
- Confirmation that Principal Adverse Impacts (PAIs) of investment decisions on sustainability factors are considered through the application of exclusion criteria (with exception of cash, derivatives, external Target Funds and internal Target Funds not following a sustainability strategy).

● **What are the objectives of the sustainable investments that the financial product partially intends to make and how does the sustainable investment contribute to such objectives?**

Sustainable investments contribute to environmental and/or social objectives, for which the Investment Manager uses as reference frameworks, among others, the UN Sustainable Development Goals (SDGs), as well as the objectives of the EU Taxonomy:

1. Climate Change Mitigation
2. Climate Change Adaptation
3. Sustainable Use and Protection of Water and Marine Resources
4. Transition to a Circular Economy
5. Pollution Prevention and Control
6. Protection and Restoration of Biodiversity and Ecosystems

The assessment of the positive contribution to the environmental or social objectives is based on a proprietary framework which combines quantitative elements with qualitative inputs from internal research. The methodology applies first a quantitative breakdown of a securities issuer into its business activities. The qualitative element of the framework is an assessment if business activities contribute positively to an environmental or a social objective.

To calculate the positive contribution on the Sub-Fund level the revenue share of each issuer attributable to business activities contributing to environmental and/or social objectives is considered provided the issuer is satisfying the Do No Significant Harm ("DNSH") and Good Governance principles, and an asset-weighted aggregation is performed as a second step. Moreover, for certain types of securities, which finance specific projects contributing to environmental or social objectives the overall investment is considered to contribute to environmental and/or social objectives, but also for these a DNSH as well as a Good Governance check for issuers is performed.

● **How do the sustainable investments that the financial product partially intends to make, not cause significant harm to any environmental or social sustainable investment objective?**

In order to ensure that Sustainable Investments do not significantly harm any other environmental and/or social objective, the Investment Manager is leveraging the PAI indicators, whereby significance thresholds have been defined to identify significantly harmful issuers. Issuers not meeting the significance threshold can be engaged for a limited time period to remediate the adverse impact. Otherwise, if the issuer does not meet the defined significance thresholds twice subsequently or in case of a failed engagement, it does not pass the DNSH assessment. Investments in securities of issuers which do not pass the DNSH assessment are not counted as sustainable investments.

● **How have the indicators for adverse impacts on sustainability factors been taken into account?**

All mandatory PAI indicators are considered either as part of the application of the exclusion criteria or through thresholds on a sectorial or absolute basis. Significance thresholds have been defined and they refer to qualitative or quantitative criteria.

Recognizing the lack of data coverage for some of the PAI indicators equivalent data points are used to assess PAI indicators when applying the DNSH assessment, when relevant, for the following indicators for corporates: share of non-renewable energy consumption and production, activities negatively affecting biodiversity-sensitive areas, emissions to water, lack of processes and compliance mechanisms to monitor compliance with UNGC principles and OECD Guidelines for Multinational Enterprises; for sovereigns: GHG Intensity and investee countries subject to social violations. In case of securities which

Principal adverse impacts are the most significant negative impacts of investment decisions on sustainability factors relating to environmental, social and employee matters, respect for human rights, anti-corruption and anti-bribery matters.

finance specific projects contributing to environmental or social objectives equivalent data at project level might be used to ensure that Sustainable Investments do not significantly harm any other environmental and/or social objective. The Investment Manager will strive to increase data coverage for PAI indicators with low data coverage by engaging with issuers and data providers. The Investment Manager will regularly evaluate whether the availability of data has increased sufficiently to potentially include assessment of such data in the investment process.

● *How are the sustainable investments aligned with the OECD Guidelines for Multinational Enterprises and the UN Guiding Principles on Business and Human Rights? Details:*

The Investment Manager's sustainable minimum exclusion list screens out companies based on their involvement in controversial practices against international norms. The core normative framework consists of the Principles of the UN Global Compact, the OECD Guidelines for Multinational Enterprises and the UN Guiding Principles for Business and Human Rights. Securities issued by companies having a severe violation of these frameworks will be restricted from the investment universe.

The EU Taxonomy sets out a "do not significant harm" principle by which Taxonomy-aligned investments should not significantly harm EU Taxonomy objectives and is accompanied by specific EU criteria.

The "do not significant harm" principle applies only to those investments underlying the financial product that take into account the EU criteria for environmentally sustainable economic activities. The investments underlying the remaining portion of this financial product do not take into account the EU criteria for environmentally sustainable economic activities.

Any other sustainable investments must also not significantly harm any environmental or social objectives.



Does this financial product consider principal adverse impacts on sustainability factors?

Yes

No

The Management Company has joined the Net Zero Asset Manager Initiative and considers PAI indicators through stewardship including engagement, both are relevant to mitigate potential adverse impact as a company.

Due to the commitment to the Net Zero Asset Manager Initiative, the Management Company aims to reduce greenhouse gas emissions in partnership with asset owner clients on decarbonisation goals, consistent with an ambition to reach net zero emission by 2050 or sooner across all assets under management. As part of this objective the Management Company will set an interim target for the proportion of assets to be managed in line with the attainment of net zero emissions by 2050 or sooner.

The Sub-Fund's Investment Manager addresses PAI indicators regarding greenhouse gas emission, biodiversity, water, waste as well as social and employee matters for corporate issuers, and, where relevant, the freedom house index is applied to investments in sovereigns. PAI indicators are considered within the Investment Manager's investment process through the means of exclusions as described in the "binding elements" section of the Sub-Fund.

The data coverage for the data required for the PAI indicators is heterogenous. The data coverage related to biodiversity, water and waste is low and the related PAI indicators are considered through exclusion of securities issued by companies having a severe violation / breach of principles and guidelines such as the Principles of the United Nations Global Compact, the OECD Guidelines for Multinational Enterprises, and the United Nations Guiding Principles for Business and Human Rights on the grounds of problematic practices around human rights, labour rights, environment, and corruption issues. Therefore, the Investment Manager will strive to increase data coverage for PAI indicators with low data coverage. The Investment Manager will regularly evaluate whether the availability of data has increased sufficiently to potentially include assessment of such data in the investment process.

The following PAI indicators are considered:

Applicable to corporate issuers

- GHG Emissions
- Carbon footprint
- GHG Intensity of investee companies
- Exposure to companies active in the fossil fuel sector

- Activities negatively affecting biodiversity-sensitive areas
- Emissions to water
- Hazardous waste ratio
- Violation of UN Global compact principles
- Lack of processes and compliance mechanisms to monitor compliance with UN Global Compact principles
- Board gender diversity
- Exposure to controversial weapons

Applicable to sovereign and supranational issuers

- Investee countries subject to social violations

The information on the PAI indicators will be available in the end-year report of the Sub-Fund.



What investment strategy does this financial product follow?

The investment strategy guides investment decisions based on factors such as investment objectives and risk tolerance.

Allianz Global Capital Plus's investment objective is to invest in Global Equity and Bond Markets in accordance with the Multi Asset Sustainability Strategy. A Sub-Fund managed according to the Multi Asset Sustainability Strategy ("MAS Strategy") invests in (i) Equities and / or Debt Securities of companies that either provide for environmental and/or social characteristics and/or pursue activities contributing to an environmental or social objective and / or invests (ii) in Green Bonds and/or Social Bonds, and/or in Sustainability Bonds and/or (iii) in SFDR Target Funds.

In case of direct investments in Equities and/or Debt Securities, the Sub-Fund's Investment Manager may choose one or more of the below strategies that promote environmental and/or social characteristics and/or pursue activities contributing to an environmental or social objective:

- SRI Strategy

The Sub-Fund or strategy promotes environmental and social characteristics through integrating environmental, social, human rights, governance and business behaviour factors into the Sub-Fund's investment process through a best-in-class approach. This encompasses the evaluation of corporate or sovereign issuers based on an SRI Rating that it is used to construct the portfolio.

- Climate Engagement with Outcome Strategy

The Sub-Fund or strategy promotes environmental characteristics through the engagement with the top 10 carbon emitting issuers to encourage their transition pathway to a low carbon economy by setting objectives which are sector specific.

- SDG-Aligned & SDG-Aligned Type A Strategy

The Sub-Fund's or strategy's Sustainable Investment objective is to invest in Equities and/or in Debt Securities of companies providing solutions that create positive environmental and social outcomes, as assessed by the contribution of companies' outputs to the attainment of one or more of the SDGs or other Sustainable Investment objectives, which the Sub-Fund's Investment Manager may additionally determine and to which the companies contribute to.

- Green Bond Strategy

The Sub-Fund's or strategy's Sustainable Investment objective is to mobilize capital markets towards the transition to a low carbon society, natural capital preservation and adaptation to climate change. The Sub-Fund or strategy invests primarily in Green Bonds financing climate change mitigation or adaptation projects or other environmental sustainability projects, notably in the following fields: energy efficiency, renewable energy, raw materials, water and land, waste management, greenhouse gas emissions reduction, biodiversity preservation or circular economy.

- Green Transition Strategy

The Sub-Fund or strategy promotes environmental and/or social characteristics through the mobilization of capital markets towards the transition to a low carbon society, natural capital preservation and adaptation to climate change.

- KPI Strategy (Absolute)

A Sub-Fund or strategy managed according to the Sustainability Key Performance Indicator Strategy (Absolute) ("KPI Strategy (Absolute)") promotes environmental objectives by applying an investment objective related to an environmental key performance indicator referred to as "Sustainability KPI" to provide transparency on the measurable sustainability outcome pursued. The "Sustainability KPI" to be measured is the GHG Intensity defined by the Weighted Average GHG Intensity (Sales) of issuers included in the Fund's portfolio. GHG Intensity will be addressed by ensuring a pre-determined year-on-year improvement pathway of the weighted average GHG Intensity on Fund's portfolio level at the Fund's fiscal year ends.

- KPI Strategy (Relative)

A Sub-Fund or strategy managed according to the Sustainability Key Performance Indicator Strategy (Relative) ("KPI Strategy (Relative)") promotes environmental objectives by applying an investment objective related to an environmental key performance indicator referred to as "Sustainability KPI" to provide transparency on the measurable sustainability outcome pursued. The "Sustainability KPI" to be measured is the GHG Intensity of issuers acquired by the Fund defined by the Weighted Average GHG Intensity (Sales). GHG Intensity of the Fund will be addressed by outperforming the Fund's benchmark (respectively the Weighted Average GHG Intensity of the issuers included in the Fund's benchmark) in terms of Weighted Average GHG Intensity.

- ESG Score Strategy

A Sub-Fund or strategy managed according to the ESG Score Strategy promotes Environment, Social and Governance factors through the ESG Score Strategy. The ESG Score Strategy aims to measure a company's resilience to long-term risks across the three pillars of Environment, Social and Governance. ESG pillars will be addressed by outperforming the Weighted Average ESG Score of issuers whose shares have been acquired by the Fund against the Weighted Average ESG Score of issuers which are components of Fund's benchmark.

- KPI Strategy (Absolute Threshold)

A Sub-Fund or strategy managed according to the Sustainability Key Performance Indicator Strategy (Absolute Threshold) ("KPI Strategy (Absolute Threshold)") targets a specific minimum allocation into Sustainable Investments. Sustainable investments are investments in economic activities which contribute to environmental and/or social objectives, for which the Investment Managers uses as reference frameworks the UN Sustainable Development Goals (SDGs), as well as the objectives of the EU Taxonomy.

The Sub-Fund's general investment approach (Sub-Fund's applicable General Asset Class Principles in combination with its individual investment restrictions) is described in the prospectus.

● **What are the binding elements of the investment strategy used to select the investments to attain each of the environmental or social characteristics promoted by this financial product?**

A Sub-Fund managed according to the Multi Asset Sustainability Strategy ("MAS Strategy") invests in (i) Equities and / or Debt Securities of companies that either provide for environmental and/or social characteristics and/or pursue activities contributing to an environmental or social objective and / or invests (ii) in Green Bonds and/or Social Bonds, and/or in Sustainability Bonds and/or (iii) in SFDR Target Funds.

Overall, the Investment Manager is required to invest min 90% of Sub-Fund's assets in SFDR Target Funds and/or in Equities and/or Debt Securities in accordance with the Multi Asset Sustainability Strategy.

- Application of the following sustainable minimum exclusion criteria for direct investments (with exception of cash, derivatives, external Target Funds, and internal Target Funds not following a sustainable strategy):
- securities issued by companies having a severe violation / breach of principles and guidelines such as the Principles of the United Nations Global Compact, the OECD Guidelines for Multinational Enterprises, and the United Nations Guiding Principles for Business and Human Rights on the grounds of problematic practices around human rights, labour rights, environment, and corruption issues,
- securities issued by companies involved in controversial weapons (anti-personnel mines, cluster munitions, chemical weapons, biological weapons, depleted uranium, white phosphorus, and nuclear weapons),
- securities issued by companies that derive more than 10% of their revenues from weapons, military equipment, and services,
- securities issued by companies that derive more than 10% of their revenue from thermal coal extraction,
- securities issued by utility companies that generate more than 20% of their revenues from coal,
- securities issued by companies involved in the production of tobacco, and securities issued by companies involved in the distribution of tobacco with more than 5% of their revenues.

Direct investments in sovereign issuers with an insufficient freedom house index score are excluded.

The sustainable minimum exclusion criteria are based on information from an external data provider and coded in pre- and post-trade compliance. The review is performed at least half yearly.

- **What is the committed minimum rate to reduce the scope of the investments considered prior to the application of that investment strategy?**

The Sub-Fund does not commit to reduce the scope of the investments by a certain minimum rate.

- **What is the policy to assess good governance practices of the investee companies?**

Good governance principles are considered by screening out companies based on their involvement in controversies around international norms corresponding to the four good governance practices: sound management structures, employee relations, remuneration of staff and tax compliance. Companies having a severe violation in either of those areas will not be investible. For certain cases, flagged issuers shall be on a watch list. These companies will appear on this watch list when the Investment Manager believes that engagement may lead to improvements or when the company is assessed to take remedial actions. Companies on the watch list remain investible unless the Investment Manager believes that the engagement or the remedial actions of the company does not lead to the desired remedy of the severe controversy.

In addition, the Sub-Fund's Investment Manager is committed to actively encourage open dialogues with investee companies on corporate governance, proxy voting and broader sustainability issues in advance of shareholder meetings (regularly for direct investments in shares). The Sub-Fund's Investment Manager's approach to proxy voting and company engagement is set out in the Management Company's Stewardship Statement.

Good governance practices include sound management structures, employee relations, remuneration of staff and tax compliance.



What is the asset allocation planned for this financial product?

Asset allocation describes the share of investments in specific assets.

Min. 90% of the Sub-Funds' assets are used to meet the environmental or social characteristics promoted by this Sub-Fund. A low portion of the Sub-Fund might contain assets which do not promote environmental or social characteristics. Example of such instruments are derivatives, cash and deposits, some Target Funds and investment with temporarily divergent or absent environmental, social, or good governance qualifications or investments outside of the specified quota to be invested as part of the Multi Asset Sustainability Strategy. Min. 1.50% of the Sub-Funds' assets will be invested in Sustainable Investments. The minimum percentage of investments that are aligned with the EU Taxonomy is 0.01%. The Sub-Fund's Investment Manager does not commit to a minimum share of environmentally Sustainable Investments that are not aligned with the EU Taxonomy. The Sub-Fund's Investment Manager does not commit to a minimum share of socially sustainable investments. While the Sub-Fund cannot commit to a minimum share of environmentally or socially sustainable investments, such investments may be freely allocated to within the Sub-Fund aggregated sustainable investment commitment disclosed (min. 1,50%).

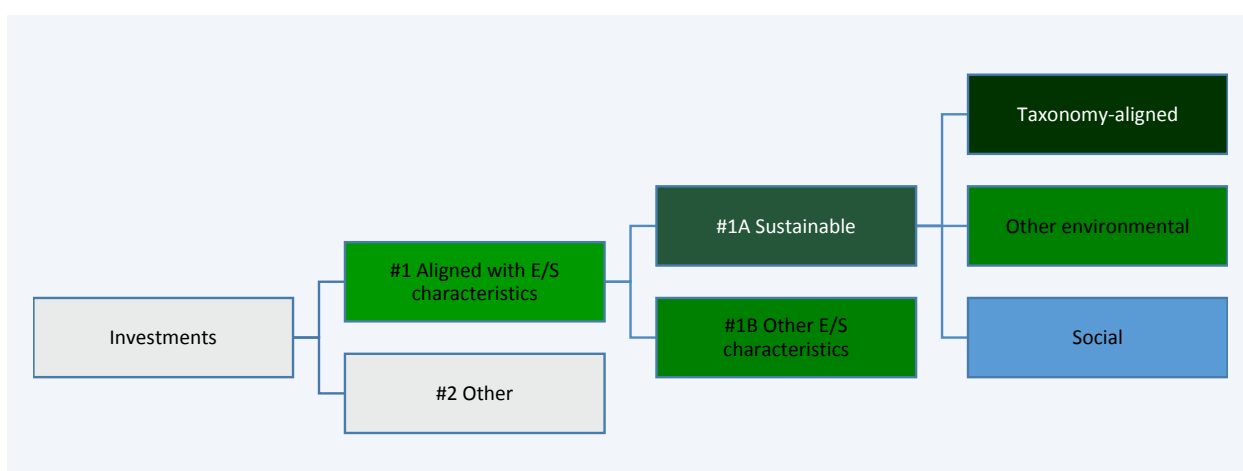

#1 Aligned with E/S characteristics includes the investments of the financial product used to attain the environmental or social characteristics promoted by the financial product.

#2 Other includes the remaining investments of the financial product which are neither aligned with the environmental or social characteristics, nor are qualified as sustainable investments.

The category #1 Aligned with E/S characteristics covers:
 - The sub-category #1A Sustainable covers sustainable investments with environmental or social objectives.
 - The sub-category #1B Other E/S characteristics covers investments aligned with the environmental or social characteristics that do not qualify as sustainable investments.

● How does the use of derivatives attain the environmental or social characteristics promoted by the financial product?

Not applicable



To what minimum extent are sustainable investments with an environmental objective aligned with the EU Taxonomy?

The Taxonomy-aligned investments include debt and/or equity in environmentally sustainable economic activities aligned with the EU-Taxonomy. The minimum percentage of investments that are aligned with the EU Taxonomy is 0.01%. Taxonomy-aligned data is provided by an external data provider. The Investment Manager has assessed the quality of such data. The data will not be subject to an assurance provided by auditors or a review by third parties. The data will not reflect any data in government bonds. As of today, there is no recognized methodology available to determine the proportion of Taxonomy-aligned activities when investing in government bonds.

Taxonomy-aligned activities in this disclosure are based on share of turnover. Pre-contractual figures use turnover as its financial metric as a default in line with the regulatory requirements and based on the fact that complete, verifiable or up-to date data for CAPEX and/or OPEX as financial metric is even less available.

Taxonomy-aligned data is only in rare cases data reported by companies in accordance with the EU Taxonomy. The data provider has derived Taxonomy-aligned data from other available equivalent public data.

● Does the financial product invest in fossil gas and/or nuclear energy related activities that comply with the EU Taxonomy ¹?

- Yes:
 - In fossil gas
 - In nuclear energy
- No

The Sub-Fund does not pursue any investments in fossil gas and/or nuclear energy related activities that comply with the EU Taxonomy. Nevertheless, as result of this investment strategy, investments may occur in corporates which are also active in these activities. Further information will be provided as part of the annual reporting, if relevant.

The two graphs below show in green the minimum percentage of investments that are aligned with the EU Taxonomy. As there is no appropriate methodology to determine the Taxonomy-alignment of sovereign bonds*, the first graph shows the Taxonomy-alignment in relation to all the investments of the financial product including sovereign bonds, while the second graph shows the Taxonomy-alignment only in relation to the investments of the financial product other than sovereign bonds.

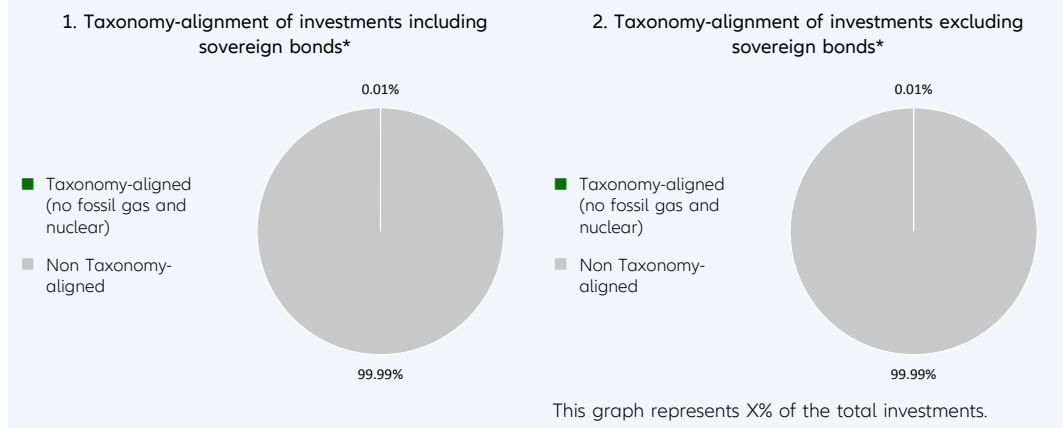

Taxonomy-aligned activities are expressed as a share of:
 - **turnover** reflecting the share of revenue from green activities of investee companies
 - **capital expenditure** (CapEx) showing the green investments made by investee companies, e.g. for a transition to a green economy.
 - **operational expenditure** (OpEx) reflecting green operational activities of investee companies.

¹ Fossil gas and/or nuclear related activities will only comply with the EU Taxonomy where they contribute to limiting climate change ("climate change mitigation") and do not significantly harm any EU Taxonomy objective - see explanatory note in the left hand margin. The full criteria for fossil gas and nuclear energy economic activities that comply with the EU Taxonomy are laid down in Commission Delegated Regulation (EU) 2022/1214.

It is noted that this Sub-Fund does not provide for a binding minimum quota for investments in sovereign bonds. Therefore, this Sub-Fund may have (but must not have) an exposure to sovereign bonds. In the absence of a binding minimum quota for investments in sovereign bonds, this graph does not generate any additional added value compared to the left-hand graph.

* For the purpose of these graphs, 'sovereign bonds' consist of all sovereign exposures

Enabling activities directly enable other activities to make a substantial contribution to an environmental objective.

Transitional activities are activities for which low-carbon alternatives are not yet available and among others have greenhouse gas emission levels corresponding to the best performance.

● What is the minimum share of investments in transitional and enabling activities?

The Sub-Fund's Investment Manager does not commit to a split of minimum taxonomy alignment into transitional, enabling activities and own performance.



What is the minimum share of sustainable investments with an environmental objective that are not aligned with the EU Taxonomy?

Taxonomy-aligned investments are considered a sub-category of Sustainable Investments. If an investment is not Taxonomy-aligned since the activity is not yet covered under the EU Taxonomy or the positive contribution is not substantial enough to comply with the Taxonomy technical screening criteria, the investment can still be considered an environmentally Sustainable Investment provided it complies with all criteria. The Investment Manager does not commit to a minimum share of environmentally Sustainable Investments that are not aligned with the EU Taxonomy. The overall sustainable investment share may also include investments with an environmental objective in economic activities that do not qualify as environmentally sustainable under the EU Taxonomy, and while the Sub-Fund cannot commit to a minimum share of environmentally or socially sustainable investments, such investments may be freely allocated to within the Sub-Fund aggregated sustainable investment commitment disclosed (min. 1,50%).



are sustainable investments with an environmental objective that **do not take into account the criteria** for environmentally sustainable economic activities under the EU Taxonomy.



What is the minimum share of socially sustainable investments?

The Investment Manager defines Sustainable Investments based on internal research, which uses, among others, the UN Sustainable Development Goals (SDGs), as well as the objectives of the EU Taxonomy as reference frameworks. The Investment Manager does not commit to a minimum share of socially Sustainable Investments, as the SDGs contain environmental as well as social objectives. The overall sustainable investment share may also include investments with a social objective, and while the Sub-Fund cannot commit to a minimum share of environmentally or socially sustainable investments, such investments may be freely allocated to within the Sub-Fund aggregated sustainable investment commitment disclosed (min. 1,50%).



What investments are included under "#2 Other", what is their purpose and are there any minimum environmental or social safeguards?

Under "#2 Other" investments into cash, Target Funds, or derivatives can be included. Derivatives might be used for efficient portfolio management (including risk hedging) and/or investment purposes, and Target Funds to benefit from a specific strategy. For those investments no environmental or social safeguards are applied.



Is a specific index designated as a reference benchmark to determine whether this financial product is aligned with the environmental and/or social characteristics that it promotes?

No reference benchmark has been designated for the purpose of attaining the environmental and/or social characteristics promoted by the Sub-Fund.

Reference benchmarks are indexes to measure whether the financial product attains the environmental or social characteristics that they promote.

- How is the reference benchmark continuously aligned with each of the environmental or social characteristics promoted by the financial product?
Not applicable
- How is the alignment of the investment strategy with the methodology of the index ensured on a continuous basis?
Not applicable
- How does the designated index differ from a relevant broad market index?
Not applicable
- Where can the methodology used for the calculation of the designated index be found?
Not applicable



Where can I find more product specific information online?

More product-specific information can be found on the website: <https://regulatory.allianzgi.com/SFDR>

Template pre-contractual disclosure for the financial products referred to in Article 8, paragraphs 1, 2 and 2a, of Regulation (EU) 2019/2088 and Article 6, first paragraph, of Regulation (EU) 2020/852

Product name:

Allianz Global Credit SRI

Legal entity identifier: 549300YBUQOG42TTJR84

Environmental and/or social characteristics

Sustainable investment means an investment in an economic activity that contributes to an environmental or social objective, provided that the investment does not significantly harm any environmental or social objective and that the investee companies follow good governance practices.

The **EU Taxonomy** is a classification system laid down in Regulation (EU) 2020/852, establishing a list of **environmentally sustainable economic activities**. That Regulation does not include a list of socially sustainable economic activities. Sustainable investments with an environmental objective might be aligned with the Taxonomy or not.

Does this financial product have a sustainable investment objective?	
<input checked="" type="radio"/> <input checked="" type="radio"/> Yes	<input checked="" type="radio"/> <input type="radio"/> No
<input type="checkbox"/> It will make a minimum of sustainable investments with an environmental objective: ___% <ul style="list-style-type: none"> <input type="checkbox"/> in economic activities that qualify as environmentally sustainable under the EU Taxonomy <input type="checkbox"/> in economic activities that do not qualify as environmentally sustainable under the EU Taxonomy 	<input checked="" type="checkbox"/> It promotes Environmental/Social (E/S) characteristics and while it does not have as its objective a sustainable investment, it will have a minimum proportion of 10.00% of sustainable investments <ul style="list-style-type: none"> <input checked="" type="checkbox"/> with an environmental objective in economic activities that qualify as environmentally sustainable under the EU Taxonomy <input checked="" type="checkbox"/> with an environmental objective in economic activities that do not qualify as environmentally sustainable under the EU Taxonomy <input checked="" type="checkbox"/> with a social objective
<input type="checkbox"/> It will make a minimum of sustainable investments with a social objective ___%	<input type="checkbox"/> It promotes E/S characteristics, but will not make any sustainable investments



What environmental and/or social characteristics are promoted by this financial product?

Allianz Global Credit SRI (the "Sub-Fund") promotes environmental, social, human rights, governance, and business behaviour factors (this domain does not apply for sovereigns issued by a Sovereign Entity) through integration of a best-in-class approach into the Sub-Fund's investment process. This encompasses the evaluation of corporate or sovereign issuers based on an SRI Rating which is used to construct the portfolio.

In addition, sustainable minimum exclusion criteria apply and Sub-Fund specific exclusion criteria apply.

No reference benchmark has been designated for the purpose of attaining the environmental and/or social characteristics promoted by the Sub-Fund.

● What sustainability indicators are used to measure the attainment of each of the environmental or social characteristics promoted by this financial product?

To measure the attainment of the environmental and/or social characteristics the following sustainability indicators are used and reported on, at the fiscal year end:

- The actual percentage of the Sub-Fund's Portfolio (Portfolio in this respect does not comprise non-rated derivatives and instruments that are non-rated by nature (e. g., cash and deposits)) assets invested in best-in-class issuers (issuers with a minimum SRI Rating of 2 out of a scale from 0-4; 0 being the worst rating and 4 the best rating) is compared to the actual percentage of the benchmarks best-in-class issuers.
- Confirmation that Principal Adverse Impacts (PAIs) of investment decisions on sustainability factors are considered through the application of exclusion criteria.

Sustainability indicators measure how the environmental or social characteristics promoted by the financial product are attained.

- **What are the objectives of the sustainable investments that the financial product partially intends to make and how does the sustainable investment contribute to such objectives?**

Sustainable investments contribute to environmental and/or social objectives, for which the Investment Manager uses as reference frameworks, among others, the UN Sustainable Development Goals (SDGs), as well as the objectives of the EU Taxonomy:

1. Climate Change Mitigation
2. Climate Change Adaptation
3. Sustainable Use and Protection of Water and Marine Resources
4. Transition to a Circular Economy
5. Pollution Prevention and Control
6. Protection and Restoration of Biodiversity and Ecosystems

The assessment of the positive contribution to the environmental or social objectives is based on a proprietary framework which combines quantitative elements with qualitative inputs from internal research. The methodology applies first a quantitative breakdown of a securities issuer into its business activities. The qualitative element of the framework is an assessment if business activities contribute positively to an environmental or a social objective.

To calculate the positive contribution on the Sub-Fund level the revenue share of each issuer attributable to business activities contributing to environmental and/or social objectives is considered provided the issuer is satisfying the Do No Significant Harm (“DNSH”) and Good Governance principles, and an asset-weighted aggregation is performed as a second step. Moreover, for certain types of securities, which finance specific projects contributing to environmental or social objectives the overall investment is considered to contribute to environmental and/or social objectives, but also for these a DNSH as well as a Good Governance check for issuers is performed.

- **How do the sustainable investments that the financial product partially intends to make, not cause significant harm to any environmental or social sustainable investment objective?**

In order to ensure that Sustainable Investments do not significantly harm any other environmental and/or social objective, the Investment Manager is leveraging the PAI indicators, whereby significance thresholds have been defined to identify significantly harmful issuers. Issuers not meeting the significance threshold can be engaged for a limited time period to remediate the adverse impact. Otherwise, if the issuer does not meet the defined significance thresholds twice subsequently or in case of a failed engagement, it does not pass the DNSH assessment. Investments in securities of issuers which do not pass the DNSH assessment are not counted as sustainable investments.

- *How have the indicators for adverse impacts on sustainability factors been taken into account?*

All mandatory PAI indicators are considered either as part of the application of the exclusion criteria or through thresholds on a sectorial or absolute basis. Significance thresholds have been defined and they refer to qualitative or quantitative criteria.

Recognizing the lack of data coverage for some of the PAI indicators equivalent data points are used to assess PAI indicators when applying the DNSH assessment, when relevant, for the following indicators for corporates: share of non-renewable energy consumption and production, activities negatively affecting biodiversity-sensitive areas, emissions to water, lack of processes and compliance mechanisms to monitor compliance with UNGC principles and OECD Guidelines for Multinational Enterprises; for sovereigns: GHG Intensity and investee countries subject to social violations. In case of securities which finance specific projects contributing to environmental or social objectives equivalent data at project level might be used to ensure that Sustainable Investments do not significantly harm any other environmental and/or social objective. The Investment Manager will strive to increase data coverage for PAI indicators with low data coverage by engaging with issuers and data providers. The Investment Manager will regularly evaluate whether the availability of data has increased sufficiently to potentially include assessment of such data in the investment process.

- *How are the sustainable investments aligned with the OECD Guidelines for Multinational Enterprises and the UN Guiding Principles on Business and Human Rights? Details:*

The Investment Manager’s sustainable minimum exclusion list screens out companies based on their involvement in controversial practices against international norms. The core normative framework consists of the Principles of the UN Global Compact, the OECD Guidelines for Multinational Enterprises

Principal adverse impacts are the most significant negative impacts of investment decisions on sustainability factors relating to environmental, social and employee matters, respect for human rights, anti-corruption and anti-bribery matters.

and the UN Guiding Principles for Business and Human Rights. Securities issued by companies having a severe violation of these frameworks will be restricted from the investment universe.

The EU Taxonomy sets out a “do not significant harm” principle by which Taxonomy-aligned investments should not significantly harm EU Taxonomy objectives and is accompanied by specific EU criteria.

The “do not significant harm” principle applies only to those investments underlying the financial product that take into account the EU criteria for environmentally sustainable economic activities. The investments underlying the remaining portion of this financial product do not take into account the EU criteria for environmentally sustainable economic activities.

Any other sustainable investments must also not significantly harm any environmental or social objectives.



Does this financial product consider principal adverse impacts on sustainability factors?

Yes

No

The Management Company has joined the Net Zero Asset Manager Initiative and considers PAI indicators through stewardship including engagement, both are relevant to mitigate potential adverse impact as a company.

Due to the commitment to the Net Zero Asset Manager Initiative, the Management Company aims to reduce greenhouse gas emissions in partnership with asset owner clients on decarbonisation goals, consistent with an ambition to reach net zero emission by 2050 or sooner across all assets under management. As part of this objective the Management Company will set an interim target for the proportion of assets to be managed in line with the attainment of net zero emissions by 2050 or sooner.

The Sub-Fund’s Investment Manager considers PAI indicators regarding greenhouse gas emission, biodiversity, water, waste as well as social and employee matters for corporate issuers, and, where relevant, the freedom house index is applied to investments in sovereigns. PAI indicators are considered within the Investment Manager’s investment process through the means of exclusions as described in the “binding elements” section of the Sub-Fund.

The data coverage for the data required for the PAI indicators is heterogenous. The data coverage related to biodiversity, water and waste is low and the related PAI indicators are considered through exclusion of securities issued by companies having a severe violation / breach of principles and guidelines such as the Principles of the United Nations Global Compact, the OECD Guidelines for Multinational Enterprises, and the United Nations Guiding Principles for Business and Human Rights on the grounds of problematic practices around human rights, labour rights, environment, and corruption issues. Therefore, the Investment Manager will strive to increase data coverage for PAI indicators with low data coverage. The Investment Manager will regularly evaluate whether the availability of data has increased sufficiently to potentially include assessment of such data in the investment process.

Additionally, PAI indicators are, among other sustainability factors, applied to derive the SRI Rating. The SRI Rating is used for the portfolio construction.

The following PAI indicators are considered:

Applicable to corporate issuers

- GHG Emissions
- Carbon footprint
- GHG Intensity of investee companies
- Exposure to companies active in the fossil fuel sector
- Activities negatively affecting biodiversity-sensitive areas
- Emissions to water
- Hazardous waste ratio
- Violation of UN Global compact principles
- Lack of processes and compliance mechanisms to monitor compliance with UN Global Compact principles
- Board gender diversity
- Exposure to controversial weapons

Applicable to sovereign and supranational issuers

- Investee countries subject to social violations

The information on the PAI indicators will be available in the end-year report of the Sub-Fund.



The investment strategy guides investment decisions based on factors such as investment objectives and risk tolerance.

What investment strategy does this financial product follow?

Allianz Global Credit SRI's investment objective is to invest in global Bond Markets in accordance with the Sustainable and Responsible Investment Strategy (SRI Strategy).

As part of the SRI best-in-class approach, the Sub-Fund takes environmental, social, human rights, governance, and business behaviour factors into account as follows:

- The aforesaid sustainability factors are analysed through SRI Research by the Investment Manager in order to assess how sustainable development and long-term issues are taken into account in the strategy of an issuer. SRI Research means the overall process of identifying potential risks as well as potential opportunities of an investment in securities of an issuer related to the analysis of sustainability factors. SRI Research data combines external research data (which might have some limitations) with internal analyses.
- Based on a combination of the results of the external and/or internal analyses of the sustainability factors, an internal rating is derived monthly (SRI Rating) and is afterwards assigned to a corporate or sovereign issuer.

This internal SRI Rating is used to rank and select or weight securities for the portfolio construction.

The Sub-Fund's general investment approach (Sub-Fund's applicable General Asset Class Principles in combination with its individual investment restrictions) is described in the prospectus.

● What are the binding elements of the investment strategy used to select the investments to attain each of the environmental or social characteristics promoted by this financial product?

The binding elements are:

- Minimum rating coverage: At least 70% of the Sub-Fund's portfolio is required to have an SRI Rating (portfolio in this respect does not comprise non-rated derivatives and instruments that are non-rated by nature e.g., cash and deposits). While most holdings of the Sub-Fund will have a corresponding SRI Rating some investments cannot be rated according to the SRI Research methodology. Examples of instruments not attaining to the SRI Rating include, but are not limited to cash, deposits, Target Funds, and non-rated investments.
- at least 80% of the rated instruments are adhering to the minimum rating threshold of 1,75 (out of a rating scale from 0 – 4; 0 being the worst rating and 4 the best rating), and maximum 20% adhering to a minimum rating threshold between 1 and 1,75.
- Application of the following sustainable minimum exclusion criteria for direct investments:
 - securities issued by companies having a severe violation / breach of principles and guidelines such as the Principles of the United Nations Global Compact, the OECD Guidelines for Multinational Enterprises, and the United Nations Guiding Principles for Business and Human Rights on the grounds of problematic practices around human rights, labour rights, environment, and corruption issues,
 - securities issued by companies involved in controversial weapons (anti-personnel mines, cluster munitions, chemical weapons, biological weapons, depleted uranium, white phosphorus, and nuclear weapons),
 - securities issued by companies that derive more than 10% of their revenues from weapons, military equipment, and services,
 - securities issued by companies that derive more than 10% of their revenue from thermal coal extraction,
 - securities issued by utility companies that generate more than 20% of their revenues from coal,
 - securities issued by companies involved in the production of tobacco, and securities issued by companies involved in the distribution of tobacco with more than 5% of their revenues.

The following Sub-Fund specific exclusion criteria for direct investments apply:

- Sub-Fund assets may not be invested in Debt Securities of issuers which provide services in relation to tobacco of more than 10% of their revenues

- Sub-fund assets may not be invested in Debt Securities of issuers which are involved in the production of gambling and/or pornography and/or which are involved in the distribution/sales of gambling and/or pornography of more than 10% of their revenues and/or which provide services in relation to gambling and/or pornography of more than 10% of their revenues
- Sub-fund assets may not be invested in Debt Securities of issuers which are involved in the production of non-conventional oil and gas and/or which provide services in relation to non-conventional oil and gas of more than 10% of their revenues
- Sub-fund assets may not be invested in Debt Securities of issuers which are involved in the production of alcohol and/or which are involved in the distribution/sales of alcohol of more than 10% of their revenues and/or which provide services in relation to alcohol of more than 20% of their revenues

Direct investments in sovereign issuers with an insufficient freedom house index score are excluded.

The sustainable minimum exclusion criteria are based on information from an external data provider and coded in pre- and post-trade compliance. The review is performed at least half yearly.

● **What is the committed minimum rate to reduce the scope of the investments considered prior to the application of that investment strategy?**

The Sub-Fund does not commit to reduce the scope of the investments by a certain minimum rate.

● **What is the policy to assess good governance practices of the investee companies?**

Good governance principles are considered by screening out companies based on their involvement in controversies around international norms corresponding to the four good governance practices: sound management structures, employee relations, remuneration of staff and tax compliance. Companies having a severe violation in either of those areas will not be investible. For certain cases, flagged issuers shall be on a watch list. These companies will appear on this watch list when the Investment Manager believes that engagement may lead to improvements or when the company is assessed to take remedial actions. Companies on the watch list remain investible unless the Investment Manager believes that the engagement or the remedial actions of the company does not lead to the desired remedy of the severe controversy.

In addition, the Sub-Fund's Investment Manager is committed to actively encourage open dialogues with investee companies on corporate governance, proxy voting and broader sustainability issues in advance of shareholder meetings (regularly for direct investments in shares). The Sub-Fund's Investment Manager's approach to proxy voting and company engagement is set out in the Management Company's Stewardship Statement.

Good governance practices include sound management structures, employee relations, remuneration of staff and tax compliance.



What is the asset allocation planned for this financial product?

Asset allocation describes the share of investments in specific assets.

Min. 70% of the Sub-Funds' assets (excluding cash and non-rated derivatives) are used to meet the environmental or social characteristics promoted by this Sub-Fund. A low portion of the Sub-Fund might contain assets which do not promote environmental or social characteristics. Examples of such instruments are derivatives, cash and deposits, some Target Funds and investment with temporarily divergent or absent environmental, social, or good governance qualifications. Min. 10% of the Sub-Funds' assets will be invested in Sustainable Investments. The minimum percentage of investments that are aligned with the EU Taxonomy is 0.01%. The Sub-Fund's Investment Manager does not commit to a minimum share of environmentally Sustainable Investments that are not aligned with the EU Taxonomy. The Sub-Fund's Investment Manager does not commit to a minimum share of socially sustainable investments. While the Sub-Fund cannot commit to a minimum share of environmentally or socially sustainable investments, such investments may be freely allocated to within the Sub-Fund aggregated sustainable investment commitment disclosed (min. 10%).

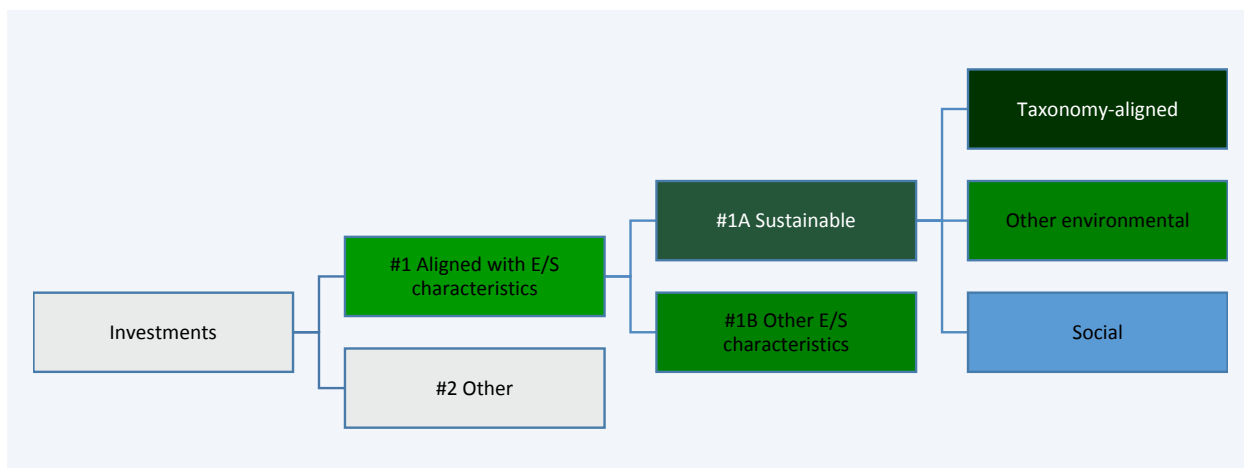

#1 Aligned with E/S characteristics includes the investments of the financial product used to attain the environmental or social characteristics promoted by the financial product.

#2 Other includes the remaining investments of the financial product which are neither aligned with the environmental or social characteristics, nor are qualified as sustainable investments.

The category **#1 Aligned with E/S characteristics** covers:

- The sub-category **#1A Sustainable** covers sustainable investments with environmental or social objectives.
- The sub-category **#1B Other E/S characteristics** covers investments aligned with the environmental or social characteristics that do not qualify as sustainable investments.

● **How does the use of derivatives attain the environmental or social characteristics promoted by the financial product?**

Not applicable



To what minimum extent are sustainable investments with an environmental objective aligned with the EU Taxonomy?

The Taxonomy-aligned investments include debt and/or equity in environmentally sustainable economic activities aligned with the EU-Taxonomy. The minimum percentage of investments that are aligned with the EU Taxonomy is 0.01%. Taxonomy-aligned data is provided by an external data provider. The Investment Manager has assessed the quality of such data. The data will not be subject to an assurance provided by auditors or a review by third parties. The data will not reflect any data in government bonds. As of today, there is no recognized methodology available to determine the proportion of Taxonomy-aligned activities when investing in government bonds.

Taxonomy-aligned activities in this disclosure are based on share of turnover. Pre-contractual figures use turnover as its financial metric as a default in line with the regulatory requirements and based on the fact that complete, verifiable or up-to date data for CAPEX and/or OPEX as financial metric is even less available.

Taxonomy-aligned data is only in rare cases data reported by companies in accordance with the EU Taxonomy. The data provider has derived Taxonomy-aligned data from other available equivalent public data.

● **Does the financial product invest in fossil gas and/or nuclear energy related activities that comply with the EU Taxonomy ¹?**

- Yes:
 - In fossil gas
 - In nuclear energy
- No

The Sub-Fund does not pursue any investments in fossil gas and/or nuclear energy related activities that comply with the EU Taxonomy. Nevertheless, as result of this investment strategy, investments may occur in corporates which are also active in these activities. Further information will be provided as part of the annual reporting, if relevant.

Taxonomy-aligned activities are expressed as a share of:

- **turnover** reflecting the share of revenue from green activities of investee companies
- **capital expenditure (CapEx)** showing the green investments made by investee companies, e.g. for a transition to a green

¹ Fossil gas and/or nuclear related activities will only comply with the EU Taxonomy where they contribute to limiting climate change ("climate change mitigation") and do not significantly harm any EU Taxonomy objective - see explanatory note in the left hand margin. The full criteria for fossil gas and nuclear energy economic activities that comply with the EU Taxonomy are laid down in Commission Delegated Regulation (EU) 2022/1214.

economy.
 - **operational expenditure (OpEx)** reflecting green operational activities of investee companies.

The two graphs below show in green the minimum percentage of investments that are aligned with the EU Taxonomy. As there is no appropriate methodology to determine the Taxonomy-alignment of sovereign bonds*, the first graph shows the Taxonomy-alignment in relation to all the investments of the financial product including sovereign bonds, while the second graph shows the Taxonomy-alignment only in relation to the investments of the financial product other than sovereign bonds.

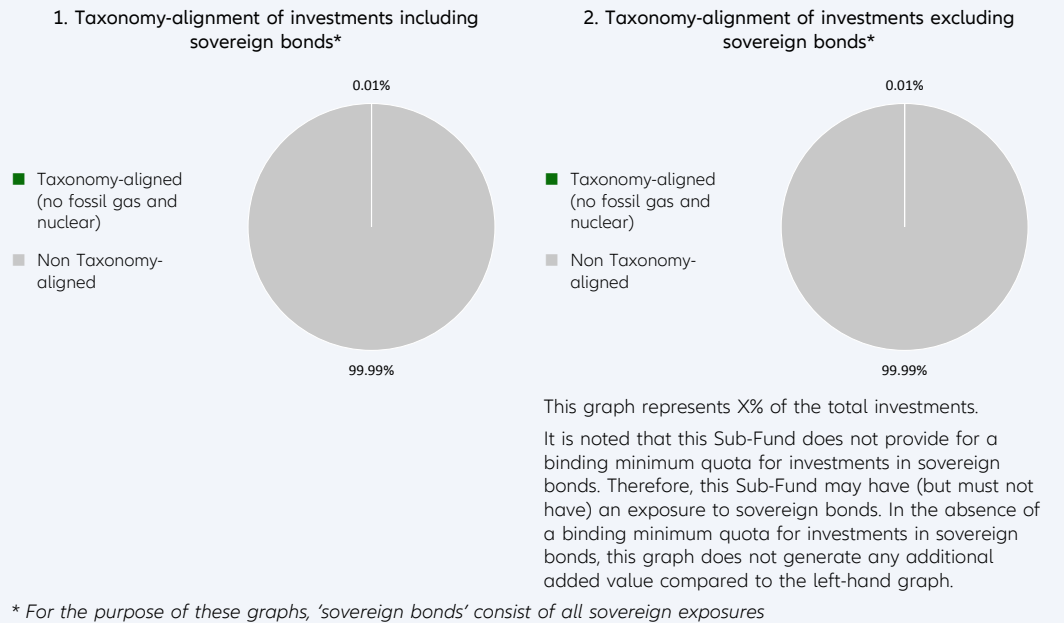

Enabling activities directly enable other activities to make a substantial contribution to an environmental objective.

Transitional activities are activities for which low-carbon alternatives are not yet available and among others have greenhouse gas emission levels corresponding to the best performance.

● **What is the minimum share of investments in transitional and enabling activities?**

The Sub-Fund's Investment Manager does not commit to a split of minimum taxonomy alignment into transitional, enabling activities and own performance.



What is the minimum share of sustainable investments with an environmental objective that are not aligned with the EU Taxonomy?

Taxonomy-aligned investments are considered a sub-category of Sustainable Investments. If an investment is not Taxonomy-aligned since the activity is not yet covered under the EU Taxonomy or the positive contribution is not substantial enough to comply with the Taxonomy technical screening criteria, the investment can still be considered an environmentally Sustainable Investment provided it complies with all criteria. The Investment Manager does not commit to a minimum share of environmentally Sustainable Investments that are not aligned with the EU Taxonomy. The overall sustainable investment share may also include investments with an environmental objective in economic activities that do not qualify as environmentally sustainable under the EU Taxonomy, and while the Sub-Fund cannot commit to a minimum share of environmentally or socially sustainable investments, such investments may be freely allocated to within the Sub-Fund aggregated sustainable investment commitment disclosed (min 10%).

are sustainable investments with an environmental objective that **do not take into account the criteria** for environmentally sustainable economic activities under the EU Taxonomy.



What is the minimum share of socially sustainable investments?

The Investment Manager defines Sustainable Investments based on internal research, which uses, among others, the UN Sustainable Development Goals (SDGs), as well as the objectives of the EU Taxonomy as reference frameworks. The Investment Manager does not commit to a minimum share of socially Sustainable Investments, as the SDGs contain environmental as well as social objectives. The overall sustainable investment share may also include investments with a social objective, and while the Sub-Fund cannot commit to a minimum share of environmentally or socially sustainable investments, such investments may be freely allocated to within the Sub-Fund aggregated sustainable investment commitment disclosed (min 10%).



What investments are included under “#2 Other”, what is their purpose and are there any minimum environmental or social safeguards?

Under “#2 Other” investments into cash, Target Funds, or derivatives can be included. Derivatives might be used for efficient portfolio management (including risk hedging) and/or investment purposes, and Target Funds to benefit from a specific strategy. For those investments no environmental or social safeguards are applied.



Is a specific index designated as a reference benchmark to determine whether this financial product is aligned with the environmental and/or social characteristics that it promotes?

No reference benchmark has been designated for the purpose of attaining the environmental and/or social characteristics promoted by the Sub-Fund.

- How is the reference benchmark continuously aligned with each of the environmental or social characteristics promoted by the financial product?

Not applicable

- How is the alignment of the investment strategy with the methodology of the index ensured on a continuous basis?

Not applicable

- How does the designated index differ from a relevant broad market index?

Not applicable

- Where can the methodology used for the calculation of the designated index be found?

Not applicable



Where can I find more product specific information online?

More product-specific information can be found on the website: <https://regulatory.allianzgi.com/SFDR>

Reference benchmarks are indexes to measure whether the financial product attains the environmental or social characteristics that they promote.

Template pre-contractual disclosure for the financial products referred to in Article 8, paragraphs 1, 2 and 2a, of Regulation (EU) 2019/2088 and Article 6, first paragraph, of Regulation (EU) 2020/852

Product name:

Allianz Global Diversified Dividend

Legal entity identifier: 5299001ECGSGJF4M2L27

Environmental and/or social characteristics

Sustainable investment means an investment in an economic activity that contributes to an environmental or social objective, provided that the investment does not significantly harm any environmental or social objective and that the investee companies follow good governance practices.

The **EU Taxonomy** is a classification system laid down in Regulation (EU) 2020/852, establishing a list of **environmentally sustainable economic activities**. That Regulation does not include a list of socially sustainable economic activities. Sustainable investments with an environmental objective might be aligned with the Taxonomy or not.

Does this financial product have a sustainable investment objective?	
<input checked="" type="radio"/> <input checked="" type="radio"/> Yes	<input checked="" type="radio"/> <input type="radio"/> No
<input type="checkbox"/> It will make a minimum of sustainable investments with an environmental objective: ___% <ul style="list-style-type: none"> <input type="checkbox"/> in economic activities that qualify as environmentally sustainable under the EU Taxonomy <input type="checkbox"/> in economic activities that do not qualify as environmentally sustainable under the EU Taxonomy 	<input checked="" type="checkbox"/> It promotes Environmental/Social (E/S) characteristics and while it does not have as its objective a sustainable investment, it will have a minimum proportion of 10.00% of sustainable investments <ul style="list-style-type: none"> <input checked="" type="checkbox"/> with an environmental objective in economic activities that qualify as environmentally sustainable under the EU Taxonomy <input checked="" type="checkbox"/> with an environmental objective in economic activities that do not qualify as environmentally sustainable under the EU Taxonomy <input checked="" type="checkbox"/> with a social objective
<input type="checkbox"/> It will make a minimum of sustainable investments with a social objective ___%	<input type="checkbox"/> It promotes E/S characteristics, but will not make any sustainable investments



What environmental and/or social characteristics are promoted by this financial product?

Allianz Global Diversified Dividend (the "Sub-Fund") promotes environmental, social, human rights, governance, and business behaviour factors (this domain does not apply for sovereigns issued by a Sovereign Entity) through integration of a best-in-class approach into the Sub-Fund's investment process. This encompasses the evaluation of corporate or sovereign issuers based on an SRI Rating which is used to construct the portfolio.

In addition, sustainable minimum exclusion criteria apply.

No reference benchmark has been designated for the purpose of attaining the environmental and/or social characteristics promoted by the Sub-Fund

Sustainability indicators measure how the environmental or social characteristics promoted by the financial product are attained.

● What sustainability indicators are used to measure the attainment of each of the environmental or social characteristics promoted by this financial product?

To measure the attainment of the environmental and/or social characteristics the following sustainability indicators are used and reported on, at the fiscal year end:

- The actual percentage of the Sub-Fund's Portfolio (Portfolio in this respect does not comprise non-rated derivatives and instruments that are non-rated by nature (e. g., cash and deposits)) assets invested in best-in-class issuers (issuers with a minimum SRI Rating of 1 out of a scale from 0-4; 0 being the worst rating and 4 the best rating) is compared to the actual percentage of the benchmarks best-in-class issuers.
- Adherence to a 20% reduction of the investment universe

- Confirmation that Principal Adverse Impacts (PAIs) of investment decisions on sustainability factors are considered through the application of exclusion criteria.

- **What are the objectives of the sustainable investments that the financial product partially intends to make and how does the sustainable investment contribute to such objectives?**

Sustainable investments contribute to environmental and/or social objectives, for which the Investment Manager uses as reference frameworks, among others, the UN Sustainable Development Goals (SDGs), as well as the objectives of the EU Taxonomy:

1. Climate Change Mitigation
2. Climate Change Adaptation
3. Sustainable Use and Protection of Water and Marine Resources
4. Transition to a Circular Economy
5. Pollution Prevention and Control
6. Protection and Restoration of Biodiversity and Ecosystems

The assessment of the positive contribution to the environmental or social objectives is based on a proprietary framework which combines quantitative elements with qualitative inputs from internal research. The methodology applies first a quantitative breakdown of a securities issuer into its business activities. The qualitative element of the framework is an assessment if business activities contribute positively to an environmental or a social objective.

To calculate the positive contribution on the Sub-Fund level the revenue share of each issuer attributable to business activities contributing to environmental and/or social objectives is considered provided the issuer is satisfying the Do No Significant Harm (“DNSH”) and Good Governance principles, and an asset-weighted aggregation is performed as a second step. Moreover, for certain types of securities, which finance specific projects contributing to environmental or social objectives the overall investment is considered to contribute to environmental and/or social objectives, but also for these a DNSH as well as a Good Governance check for issuers is performed.

- **How do the sustainable investments that the financial product partially intends to make, not cause significant harm to any environmental or social sustainable investment objective?**

In order to ensure that Sustainable Investments do not significantly harm any other environmental and/or social objective, the Investment Manager is leveraging the PAI indicators, whereby significance thresholds have been defined to identify significantly harmful issuers. Issuers not meeting the significance threshold can be engaged for a limited time period to remediate the adverse impact. Otherwise, if the issuer does not meet the defined significance thresholds twice subsequently or in case of a failed engagement, it does not pass the DNSH assessment. Investments in securities of issuers which do not pass the DNSH assessment are not counted as sustainable investments.

- *How have the indicators for adverse impacts on sustainability factors been taken into account?*

All mandatory PAI indicators are considered either as part of the application of the exclusion criteria or through thresholds on a sectorial or absolute basis. Significance thresholds have been defined and they refer to qualitative or quantitative criteria.

Recognizing the lack of data coverage for some of the PAI indicators equivalent data points are used to assess PAI indicators when applying the DNSH assessment, when relevant, for the following indicators for corporates: share of non-renewable energy consumption and production, activities negatively affecting biodiversity-sensitive areas, emissions to water, lack of processes and compliance mechanisms to monitor compliance with UNGC principles and OECD Guidelines for Multinational Enterprises; for sovereigns: GHG Intensity and investee countries subject to social violations. In case of securities which finance specific projects contributing to environmental or social objectives equivalent data at project level might be used to ensure that Sustainable Investments do not significantly harm any other environmental and/or social objective. The Investment Manager will strive to increase data coverage for PAI indicators with low data coverage by engaging with issuers and data providers. The Investment Manager will regularly evaluate whether the availability of data has increased sufficiently to potentially include assessment of such data in the investment process.

Principal adverse impacts are the most significant negative impacts of investment decisions on sustainability factors relating to environmental, social and employee matters, respect for human rights, anti-corruption and anti-bribery matters.

- *How are the sustainable investments aligned with the OECD Guidelines for Multinational Enterprises and the UN Guiding Principles on Business and Human Rights? Details:*

The Investment Manager's sustainable minimum exclusion list screens out companies based on their involvement in controversial practices against international norms. The core normative framework consists of the Principles of the UN Global Compact, the OECD Guidelines for Multinational Enterprises and the UN Guiding Principles for Business and Human Rights. Securities issued by companies having a severe violation of these frameworks will be restricted from the investment universe.

The EU Taxonomy sets out a "do not significant harm" principle by which Taxonomy-aligned investments should not significantly harm EU Taxonomy objectives and is accompanied by specific EU criteria.

The "do not significant harm" principle applies only to those investments underlying the financial product that take into account the EU criteria for environmentally sustainable economic activities. The investments underlying the remaining portion of this financial product do not take into account the EU criteria for environmentally sustainable economic activities.

Any other sustainable investments must also not significantly harm any environmental or social objectives.



Does this financial product consider principal adverse impacts on sustainability factors?

Yes

No

The Management Company has joined the Net Zero Asset Manager Initiative and considers PAI indicators through stewardship including engagement, both are relevant to mitigate potential adverse impact as a company.

Due to the commitment to the Net Zero Asset Manager Initiative, the Management Company aims to reduce greenhouse gas emissions in partnership with asset owner clients on decarbonisation goals, consistent with an ambition to reach net zero emission by 2050 or sooner across all assets under management. As part of this objective the Management Company will set an interim target for the proportion of assets to be managed in line with the attainment of net zero emissions by 2050 or sooner.

The Sub-Fund's Investment Manager considers PAI indicators regarding greenhouse gas emission, biodiversity, water, waste as well as social and employee matters for corporate issuers, and, where relevant, the freedom house index is applied to investments in sovereigns. PAI indicators are considered within the Investment Manager's investment process through the means of exclusions as described in the "binding elements" section of the Sub-Fund.

The data coverage for the data required for the PAI indicators is heterogenous. The data coverage related to biodiversity, water and waste is low and the related PAI indicators are considered through exclusion of securities issued by companies having a severe violation / breach of principles and guidelines such as the Principles of the United Nations Global Compact, the OECD Guidelines for Multinational Enterprises, and the United Nations Guiding Principles for Business and Human Rights on the grounds of problematic practices around human rights, labour rights, environment, and corruption issues. Therefore, the Investment Manager will strive to increase data coverage for PAI indicators with low data coverage. The Investment Manager will regularly evaluate whether the availability of data has increased sufficiently to potentially include assessment of such data in the investment process.

Additionally, PAI indicators are, among other sustainability factors, applied to derive the SRI Rating. The SRI Rating is used for the portfolio construction.

The following PAI indicators are considered:

Applicable to corporate issuers

- GHG Emissions
- Carbon footprint
- GHG Intensity of investee companies
- Exposure to companies active in the fossil fuel sector
- Activities negatively affecting biodiversity-sensitive areas
- Emissions to water
- Hazardous waste ratio

- Violation of UN Global compact principles
- Lack of processes and compliance mechanisms to monitor compliance with UN Global Compact principles
- Board gender diversity
- Exposure to controversial weapons

Applicable to sovereign and supranational issuers

- Investee countries subject to social violations



What investment strategy does this financial product follow?

The investment strategy guides investment decisions based on factors such as investment objectives and risk tolerance.

Allianz Global Diversified Dividend's investment strategy is to invest in the global equity markets in accordance with the Sustainable and Responsible Investment Strategy (SRI Strategy).

As part of the SRI best-in-class approach, the Sub-Fund takes environmental, social, human rights, governance, and business behaviour factors into account as follows:

- The aforesaid sustainability factors are analysed through SRI Research by the Investment Manager in order to assess how sustainable development and long-term issues are taken into account in the strategy of an issuer. SRI Research means the overall process of identifying potential risks as well as potential opportunities of an investment in securities of an issuer related to the analysis of sustainability factors. SRI Research data combines external research data (which might have some limitations) with internal analyses.
- Based on a combination of the results of the external and/or internal analyses of the sustainability factors, an internal rating is derived monthly (SRI Rating) and is afterwards assigned to a corporate or sovereign issuer.

This internal SRI Rating is used to rank and select or weight securities for the portfolio construction.

The Sub-Fund's general investment approach (Sub-Fund's applicable General Asset Class Principles in combination with its individual investment restrictions) is described in the prospectus.

● What are the binding elements of the investment strategy used to select the investments to attain each of the environmental or social characteristics promoted by this financial product?

The binding elements are:

- Minimum rating coverage: At least 90% of Sub-Fund's portfolio is required to have an SRI Rating (portfolio in this respect does not comprise non-rated derivatives and instruments that are non-rated by nature e.g., cash and deposits). While most holdings of Sub-Funds will have a corresponding SRI Rating some investments cannot be rated according to the SRI Research methodology. Examples of instruments not attaining to the SRI Rating include, but are not limited to, cash, deposits, Target Funds and non-rated investments.
- The rated instruments are adhering to the minimum rating threshold of 1 (out of a rating scale from 0 – 4; 0 being the worst rating and 4 the best rating).
- Reduction of investment universe by excluding at least 20% of issuers.
- Application of the below sustainable minimum exclusion criteria.
- Application of the following sustainable minimum exclusion criteria for direct investments:
 - securities issued by companies having a severe violation / breach of principles and guidelines such as the Principles of the United Nations Global Compact, the OECD Guidelines for Multinational Enterprises, and the United Nations Guiding Principles for Business and Human Rights on the grounds of problematic practices around human rights, labour rights, environment, and corruption issues,
 - securities issued by companies involved in controversial weapons (anti-personnel mines, cluster munitions, chemical weapons, biological weapons, depleted uranium, white phosphorus, and nuclear weapons),
 - securities issued by companies that derive more than 10% of their revenues from weapons, military equipment, and services,
 - securities issued by companies that derive more than 10% of their revenue from thermal coal extraction,
 - securities issued by utility companies that generate more than 20% of their revenues from coal,

- securities issued by companies involved in the production of tobacco, and securities issued by companies involved in the distribution of tobacco with more than 5% of their revenues.

Direct investments in sovereign issuers with an insufficient freedom house index score are excluded.

The sustainable minimum exclusion criteria are based on information from an external data provider and coded in pre- and post-trade compliance. The review is performed at least half yearly.

- **What is the committed minimum rate to reduce the scope of the investments considered prior to the application of that investment strategy?**

The Sub-Fund commits to reduce the investment universe by at least 20%.

- **What is the policy to assess good governance practices of the investee companies?**

Good governance principles are considered by screening out companies based on their involvement in controversies around international norms corresponding to the four good governance practices: sound management structures, employee relations, remuneration of staff and tax compliance. Companies having a severe violation in either of those areas will not be investible. For certain cases, flagged issuers shall be on a watch list. These companies will appear on this watch list when the Investment Manager believes that engagement may lead to improvements or when the company is assessed to take remedial actions. Companies on the watch list remain investible unless the Investment Manager believes that the engagement or the remedial actions of the company does not lead to the desired remedy of the severe controversy.

In addition, the Sub-Fund’s Investment Manager is committed to actively encourage open dialogues with investee companies on corporate governance, proxy voting and broader sustainability issues in advance of shareholder meetings (regularly for direct investments in shares). The Sub-Fund’s Investment Manager’s approach to proxy voting and company engagement is set out in the Management Company’s Stewardship Statement.

Good governance practices include sound management structures, employee relations, remuneration of staff and tax compliance.



What is the asset allocation planned for this financial product?

Asset allocation describes the share of investments in specific assets.

Min. 90% of the Sub-Funds’ assets (excluding cash and non-rated derivatives) are used to meet the environmental or social characteristics promoted by this Sub-Fund. A low portion of the Sub-Fund might contain assets which do not promote environmental or social characteristics. Examples of such instruments are derivatives, cash and deposits, some Target Funds and investment with temporarily divergent or absent environmental, social, or good governance qualifications. Min. 10% of the Sub-Funds' assets will be invested in Sustainable Investments. The minimum percentage of investments that are aligned with the EU Taxonomy is 0.01%. The Sub-Fund’s Investment Manager does not commit to a minimum share of environmentally Sustainable Investments that are not aligned with the EU Taxonomy. The Sub-Fund’s Investment Manager does not commit to a minimum share of socially sustainable investments. While the Sub-Fund cannot commit to a minimum share of environmentally or socially sustainable investments, such investments may be freely allocated to within the Sub-Fund aggregated sustainable investment commitment disclosed (min. 10%).

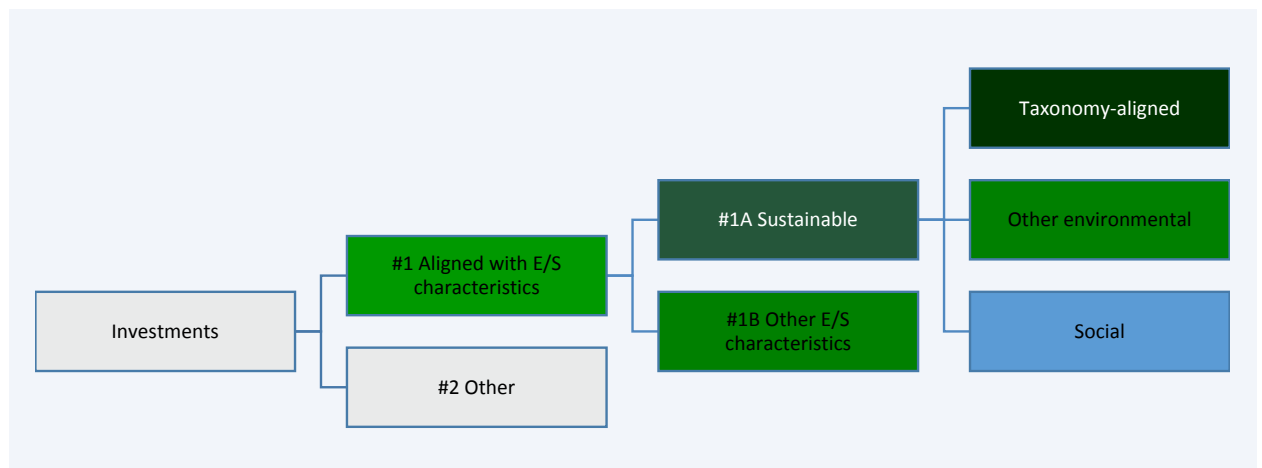

#1 Aligned with E/S characteristics includes the investments of the financial product used to attain the environmental or social characteristics promoted by the financial product.

#2 Other includes the remaining investments of the financial product which are neither aligned with the environmental or social characteristics, nor are qualified as sustainable investments.

The category **#1 Aligned with E/S characteristics** covers:

- The sub-category **#1A Sustainable** covers sustainable investments with environmental or social objectives.
- The sub-category **#1B Other E/S characteristics** covers investments aligned with the environmental or social characteristics that do not qualify as sustainable investments.

- **How does the use of derivatives attain the environmental or social characteristics promoted by the financial product?**

Not applicable



To what minimum extent are sustainable investments with an environmental objective aligned with the EU Taxonomy?

The Taxonomy-aligned investments include debt and/or equity in environmentally sustainable economic activities aligned with the EU-Taxonomy. The minimum percentage of investments that are aligned with the EU Taxonomy is 0.01%. Taxonomy-aligned data is provided by an external data provider. The Investment Manager has assessed the quality of such data. The data will not be subject to an assurance provided by auditors or a review by third parties. The data will not reflect any data in government bonds. As of today, there is no recognized methodology available to determine the proportion of Taxonomy-aligned activities when investing in government bonds.

Taxonomy-aligned activities in this disclosure are based on share of turnover. Pre-contractual figures use turnover as its financial metric as a default in line with the regulatory requirements and based on the fact that complete, verifiable or up-to date data for CAPEX and/or OPEX as financial metric is even less available.

Taxonomy-aligned data is only in rare cases data reported by companies in accordance with the EU Taxonomy. The data provider has derived Taxonomy-aligned data from other available equivalent public data.

- **Does the financial product invest in fossil gas and/or nuclear energy related activities that comply with the EU Taxonomy¹?**

Yes:

In fossil gas In nuclear energy

No

The Sub-Fund does not pursue any investments in fossil gas and/or nuclear energy related activities that comply with the EU Taxonomy. Nevertheless, as result of this investment strategy, investments may occur in corporates which are also active in these activities. Further information will be provided as part of the annual reporting, if relevant.

Taxonomy-aligned activities are expressed as a share of:

- **turnover** reflecting the share of revenue from green activities of investee companies
- **capital expenditure** (CapEx) showing the green investments made by investee companies, e.g. for a transition to a green economy.
- **operational expenditure** (OpEx) reflecting green operational activities of investee companies.

¹ Fossil gas and/or nuclear related activities will only comply with the EU Taxonomy where they contribute to limiting climate change ("climate change mitigation") and do not significantly harm any EU Taxonomy objective - see explanatory note in the left hand margin. The full criteria for fossil gas and nuclear energy economic activities that comply with the EU Taxonomy are laid down in Commission Delegated Regulation (EU) 2022/1214.

The two graphs below show in green the minimum percentage of investments that are aligned with the EU Taxonomy. As there is no appropriate methodology to determine the Taxonomy-alignment of sovereign bonds*, the first graph shows the Taxonomy-alignment in relation to all the investments of the financial product including sovereign bonds, while the second graph shows the Taxonomy-alignment only in relation to the investments of the financial product other than sovereign bonds.

1. Taxonomy-alignment of investments including sovereign bonds*

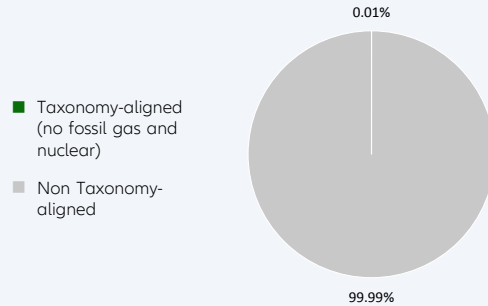

2. Taxonomy-alignment of investments excluding sovereign bonds*

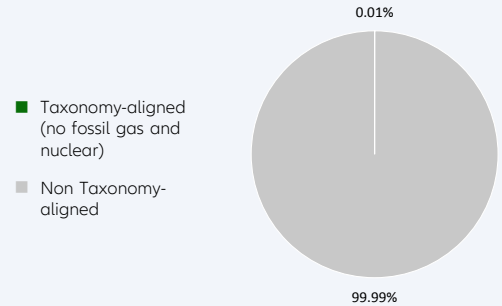

This graph represents X% of the total investments. It is noted that this Sub-Fund does not provide for a binding minimum quota for investments in sovereign bonds. Therefore, this Sub-Fund may have (but must not have) an exposure to sovereign bonds. In the absence of a binding minimum quota for investments in sovereign bonds, this graph does not generate any additional added value compared to the left-hand graph.

* For the purpose of these graphs, 'sovereign bonds' consist of all sovereign exposures

Enabling activities directly enable other activities to make a substantial contribution to an environmental objective.

Transitional activities are activities for which low-carbon alternatives are not yet available and among others have greenhouse gas emission levels corresponding to the best performance.

● **What is the minimum share of investments in transitional and enabling activities?**

The Sub-Fund's Investment Manager does not commit to a split of minimum taxonomy alignment into transitional, enabling activities and own performance.



What is the minimum share of sustainable investments with an environmental objective that are not aligned with the EU Taxonomy?

Taxonomy-aligned investments are considered a sub-category of Sustainable Investments. If an investment is not Taxonomy-aligned since the activity is not yet covered under the EU Taxonomy or the positive contribution is not substantial enough to comply with the Taxonomy technical screening criteria, the investment can still be considered an environmentally Sustainable Investment provided it complies with all criteria. The Investment Manager does not commit to a minimum share of environmentally Sustainable Investments that are not aligned with the EU Taxonomy. The overall sustainable investment share may also include investments with an environmental objective in economic activities that do not qualify as environmentally sustainable under the EU Taxonomy, and while the Sub-Fund cannot commit to a minimum share of environmentally or socially sustainable investments, such investments may be freely allocated to within the Sub-Fund aggregated sustainable investment commitment disclosed (min 10%).

 are sustainable investments with an environmental objective that **do not take into account the criteria** for environmentally sustainable economic activities under the EU Taxonomy.



What is the minimum share of socially sustainable investments?

The Investment Manager defines Sustainable Investments based on internal research, which uses, among others, the UN Sustainable Development Goals (SDGs), as well as the objectives of the EU Taxonomy as reference frameworks. The Investment Manager does not commit to a minimum share of socially Sustainable Investments, as the SDGs contain environmental as well as social objectives. The overall sustainable investment share may also include investments with a social objective, and while the Sub-Fund cannot commit to a minimum share of environmentally or socially sustainable investments, such investments may be freely allocated to within the Sub-Fund aggregated sustainable investment commitment disclosed (min 10%).



What investments are included under “#2 Other”, what is their purpose and are there any minimum environmental or social safeguards?

Under “#2 Other” investments into cash, Target Funds, or derivatives can be included. Derivatives might be used for efficient portfolio management (including risk hedging) and/or investment purposes, and Target Funds to benefit from a specific strategy. For those investments no environmental or social safeguards are applied.



Is a specific index designated as a reference benchmark to determine whether this financial product is aligned with the environmental and/or social characteristics that it promotes?

No reference benchmark has been designated for the purpose of attaining the environmental and/or social characteristics promoted by the Sub-Fund.

- How is the reference benchmark continuously aligned with each of the environmental or social characteristics promoted by the financial product?

Not applicable

- How is the alignment of the investment strategy with the methodology of the index ensured on a continuous basis?

Not applicable

- How does the designated index differ from a relevant broad market index?

Not applicable

- Where can the methodology used for the calculation of the designated index be found?

Not applicable

Reference benchmarks are indexes to measure whether the financial product attains the environmental or social characteristics that they promote.



Where can I find more product specific information online?

More product-specific information can be found on the website: <https://regulatory.allianzgi.com/SFDR>

Template pre-contractual disclosure for the financial products referred to in Article 8, paragraphs 1, 2 and 2a, of Regulation (EU) 2019/2088 and Article 6, first paragraph, of Regulation (EU) 2020/852

Product name:

Allianz Global Equity Growth

Legal entity identifier: 5299007LC5RZOIZQJK05

Environmental and/or social characteristics

Sustainable investment means an investment in an economic activity that contributes to an environmental or social objective, provided that the investment does not significantly harm any environmental or social objective and that the investee companies follow good governance practices.

The EU Taxonomy is a classification system laid down in Regulation (EU) 2020/852, establishing a list of **environmentally sustainable economic activities**. That Regulation does not include a list of socially sustainable economic activities. Sustainable investments with an environmental objective might be aligned with the Taxonomy or not.

Does this financial product have a sustainable investment objective?

Yes

No

It will make a minimum of **sustainable investments with an environmental objective**: ___%

in economic activities that qualify as environmentally sustainable under the EU Taxonomy

in economic activities that do not qualify as environmentally sustainable under the EU Taxonomy

It will make a minimum of **sustainable investments with a social objective** ___%

It **promotes Environmental/Social (E/S) characteristics** and while it does not have as its objective a sustainable investment, it will have a minimum proportion of ___% of sustainable investments

with an environmental objective in economic activities that qualify as environmentally sustainable under the EU Taxonomy

with an environmental objective in economic activities that do not qualify as environmentally sustainable under the EU Taxonomy

with a social objective

It promotes E/S characteristics, but **will not make any sustainable investments**



What environmental and/or social characteristics are promoted by this financial product?

Allianz Global Equity Growth (the "Sub-Fund") is managed according to the Sustainability Key Performance Indicator Strategy (Relative) ("KPI Strategy (Relative)") which addresses greenhouse gas (GHG) Intensity. The "Sustainability KPI" measures the GHG Intensity defined by the weighted average intensity of greenhouse gas emissions based on company's annual sales ("GHG Intensity").

GHG Intensity will be addressed by outperforming the Weighted Average GHG Intensity against its benchmark.

In addition, sustainable minimum exclusion criteria apply.

A reference benchmark has been designated for the purpose of attaining the environmental and/or social characteristics promoted by the Sub-Fund.

● What sustainability indicators are used to measure the attainment of each of the environmental or social characteristics promoted by this financial product?

To measure the attainment of the environmental and/or social characteristics the following sustainability indicators are used and reported on, at the fiscal year end:

- The actual percentage of KPI coverage of the Sub-Fund's Portfolio (Portfolio in this respect does not comprise derivatives and instruments that are non-evaluated by nature (e. g., cash and deposits)).
- The actual weighted average GHG Intensity portfolio vs weighted average GHG Intensity of the benchmark.

Sustainability indicators measure how the environmental or social characteristics promoted by the financial product are attained.

- Confirmation that Principal Adverse Impacts (PAIs) of investment decisions on sustainability factors are considered through the application of exclusion criteria.

- **What are the objectives of the sustainable investments that the financial product partially intends to make and how does the sustainable investment contribute to such objectives?**

Not applicable

- **How do the sustainable investments that the financial product partially intends to make, not cause significant harm to any environmental or social sustainable investment objective?**

Not applicable

- *How have the indicators for adverse impacts on sustainability factors been taken into account?*

Not applicable

- *How are the sustainable investments aligned with the OECD Guidelines for Multinational Enterprises and the UN Guiding Principles on Business and Human Rights? Details:*

Not applicable

Principal adverse impacts are the most significant negative impacts of investment decisions on sustainability factors relating to environmental, social and employee matters, respect for human rights, anti-corruption and anti-bribery matters.



Does this financial product consider principal adverse impacts on sustainability factors?

Yes

No

The Management Company has joined the Net Zero Asset Manager Initiative and considers PAI indicators through stewardship including engagement, both are relevant to mitigate potential adverse impact as a company.

Due to the commitment to the Net Zero Asset Manager Initiative, the Management Company aims to reduce greenhouse gas emissions in partnership with asset owner clients on decarbonisation goals, consistent with an ambition to reach net zero emission by 2050 or sooner across all assets under management. As part of this objective the Management Company will set an interim target for the proportion of assets to be managed in line with the attainment of net zero emissions by 2050 or sooner.

The Sub-Fund's Investment Manager addresses PAI indicators regarding greenhouse gas emission, biodiversity, water, waste as well as social and employee matters for corporate issuers, and, where relevant, the freedom house index is applied to investments in sovereigns. PAI indicators are considered within the Investment Manager's investment process through the means of exclusions as described in the "binding elements" section of the Sub-Fund.

The data coverage for the data required for the PAI indicators is heterogenous. The data coverage related to biodiversity, water and waste is low and the related PAI indicators are considered through exclusion of securities issued by companies having a severe violation / breach of principles and guidelines such as the Principles of the United Nations Global Compact, the OECD Guidelines for Multinational Enterprises, and the United Nations Guiding Principles for Business and Human Rights on the grounds of problematic practices around human rights, labour rights, environment, and corruption issues. Therefore, the Investment Manager will strive to increase data coverage for PAI indicators with low data coverage. The Investment Manager will regularly evaluate whether the availability of data has increased sufficiently to potentially include assessment of such data in the investment process.

Additionally, the Investment manager considers GHG related PAI indicators by outperforming the Weighted Average GHG Intensity against its benchmark.

The following PAI indicators are considered:

Applicable to corporate issuers

- GHG Emissions
- Carbon footprint
- GHG Intensity of investee companies
- Exposure to companies active in the fossil fuel sector
- Activities negatively affecting biodiversity-sensitive areas
- Emissions to water
- Hazardous waste ratio
- Violation of UN Global compact principles
- Lack of processes and compliance mechanisms to monitor compliance with UN Global Compact principles
- Board gender diversity
- Exposure to controversial weapons

Applicable to sovereign and supranational issuers

- Investee countries subject to social violations

The information on the PAI indicators will be available in the end-year report of the Sub-Fund.



What investment strategy does this financial product follow?

The investment strategy guides investment decisions based on factors such as investment objectives and risk tolerance.

Allianz Global Equity Growth's investment objective is to invest in global equity markets with a focus on growth stocks in accordance with the Sustainability Key Performance Indicator Strategy (Relative) ("KPI Strategy (Relative)").

The Sub-Fund's strategy is to outperform the Weighted Average GHG Intensity against its benchmark. The outperformance is determined as the excess between the Sub-Fund's weighted average GHG Intensity and the Sub-Fund's benchmark Weighted Average GHG Intensity.

The weighted average GHG Intensity is the weighted average of the Sub-Fund's GHG Intensity (in tCO₂e per Millions of sales). Sales represent company's annual sales. This ratio of GHG normalized by Sales facilitates comparison between companies of different sizes. The ratio is in tCO₂e per Millions of sales. The metric allows comparing weighted average GHG Intensities of different portfolios to identify portfolios comprised of more GHG-efficient issuers in terms of the issuer's sales. The portfolio weights (and benchmark or universe weights) are rebased such that only issuers with GHG emissions data available are considered in the calculation. GHG represents a respective issuer's greenhouse gas emissions. To determine the GHG Intensity of a company issuer, GHG Intensity data from third party data providers will be used. The GHG intensity is analysed by the Investment Manager and is considered within the securities selection process in order to meet the Sub-Fund Investment objective.

The proportion of assets which do not have a GHG intensity assessment is expected to be low. Examples of instruments not having a GHG intensity assessment are cash and deposits, some Target Funds, and investments for which the GHG intensity is deemed to be not appropriate and/or data is not available.

The Sub-Fund's general investment approach (Sub-Fund's applicable General Asset Class Principles in combination with its individual investment restrictions) is described in the prospectus.

● What are the binding elements of the investment strategy used to select the investments to attain each of the environmental or social characteristics promoted by this financial product?

The binding elements are:

- Min. 80% KPI coverage of the Sub-Fund's Portfolio (Portfolio in this respect does not comprise derivatives and instruments that are non-evaluated by nature (e. g., cash and deposits)).
- Min. 20% outperformance of benchmark in terms of Weighted Average GHG Intensity.

- Application of the following sustainable minimum exclusion criteria for direct investments:
- securities issued by companies having a severe violation / breach of principles and guidelines such as the Principles of the United Nations Global Compact, the OECD Guidelines for Multinational Enterprises, and the United Nations Guiding Principles for Business and Human Rights on the grounds of problematic practices around human rights, labour rights, environment, and corruption,
- securities issued by companies involved in controversial weapons (anti-personnel mines, cluster munitions, chemical weapons, biological weapons, depleted uranium, white phosphorus, and nuclear weapons),
- securities issued by companies that derive more than 10% of their revenues from weapons, military equipment, and services,
- securities issued by companies that derive more than 10% of their revenue from thermal coal extraction
- securities issued by utility companies that generate more than 20% of their revenues from coal,
- securities issued by companies involved in the production of tobacco, and securities issued by companies involved in the distribution of tobacco with more than 5% of their revenues.

Direct investments in sovereign issuers with an insufficient freedom house index score are excluded.

The sustainable minimum exclusion criteria are based on information from an external data provider and coded in pre- and post-trade compliance. The review is performed at least half yearly.

● **What is the committed minimum rate to reduce the scope of the investments considered prior to the application of that investment strategy?**

The Sub-Fund does not commit to reduce the scope of the investments by a certain minimum rate.

● **What is the policy to assess good governance practices of the investee companies?**

Good governance principles are considered by screening out companies based on their involvement in controversies around international norms corresponding to the four good governance practices: sound management structures, employee relations, remuneration of staff and tax compliance. Companies having a severe violation in either of those areas will not be investible. For certain cases, flagged issuers shall be on a watch list. These companies will appear on this watch list when the Investment Manager believes that engagement may lead to improvements or when the company is assessed to take remedial actions. Companies on the watch list remain investible unless the Investment Manager believes that the engagement or the remedial actions of the company does not lead to the desired remedy of the severe controversy.

In addition, the Sub-Fund's Investment Manager is committed to actively encourage open dialogues with investee companies on corporate governance, proxy voting and broader sustainability issues in advance of shareholder meetings (regularly for direct investments in shares). The Sub-Fund's Investment Manager's approach to proxy voting and company engagement is set out in the Management Company's Stewardship Statement.

Good governance practices include sound management structures, employee relations, remuneration of staff and tax compliance.



What is the asset allocation planned for this financial product?

Asset allocation describes the share of investments in specific assets.

Min. 80% of the Sub-Funds' assets (excluding cash, and derivatives) are used to meet the environmental or social characteristics promoted by this Sub-Fund. A low portion of the Sub-Fund might contain assets which do not promote environmental or social characteristics. Example of such instruments are derivatives, cash and deposits, some Target Funds and investment with temporarily divergent or absent environmental, social, or good governance qualifications.

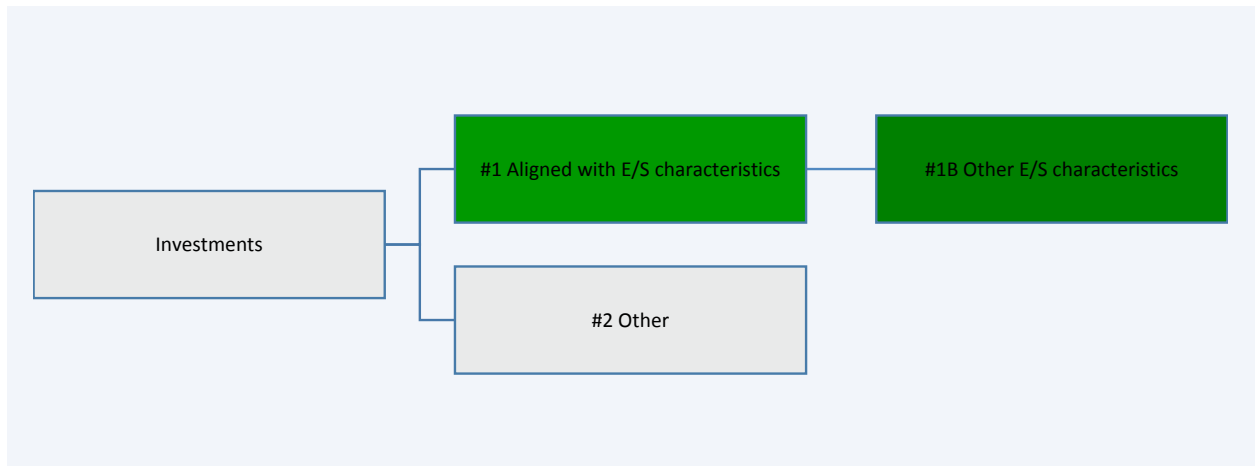

#1 Aligned with E/S characteristics includes the investments of the financial product used to attain the environmental or social characteristics promoted by the financial product.

#2 Other includes the remaining investments of the financial product which are neither aligned with the environmental or social characteristics, nor are qualified as sustainable investments.

The category **#1 Aligned with E/S characteristics** covers:

- The sub-category **#1A Sustainable** covers sustainable investments with environmental or social objectives.
- The sub-category **#1B Other E/S characteristics** covers investments aligned with the environmental or social characteristics that do not qualify as sustainable investments.

- **How does the use of derivatives attain the environmental or social characteristics promoted by the financial product?**

Not applicable



To what minimum extent are sustainable investments with an environmental objective aligned with the EU Taxonomy?

The Sub-Fund's Investment Manager does not commit to a minimum share of sustainable investments with an environmental objective aligned with the EU Taxonomy.

- **Does the financial product invest in fossil gas and/or nuclear energy related activities that comply with the EU Taxonomy¹?**

Yes:

In fossil gas In nuclear energy

No

Taxonomy-aligned activities are expressed as a share of:

- **turnover** reflecting the share of revenue from green activities of investee companies
- **capital expenditure** (CapEx) showing the green investments made by investee companies, e.g. for a transition to a green economy.
- **operational expenditure** (OpEx) reflecting green operational activities of investee companies.

¹ Fossil gas and/or nuclear related activities will only comply with the EU Taxonomy where they contribute to limiting climate change ("climate change mitigation") and do not significantly harm any EU Taxonomy objective - see explanatory note in the left hand margin. The full criteria for fossil gas and nuclear energy economic activities that comply with the EU Taxonomy are laid down in Commission Delegated Regulation (EU) 2022/1214.

The two graphs below show in green the minimum percentage of investments that are aligned with the EU Taxonomy. As there is no appropriate methodology to determine the Taxonomy-alignment of sovereign bonds*, the first graph shows the Taxonomy-alignment in relation to all the investments of the financial product including sovereign bonds, while the second graph shows the Taxonomy-alignment only in relation to the investments of the financial product other than sovereign bonds.

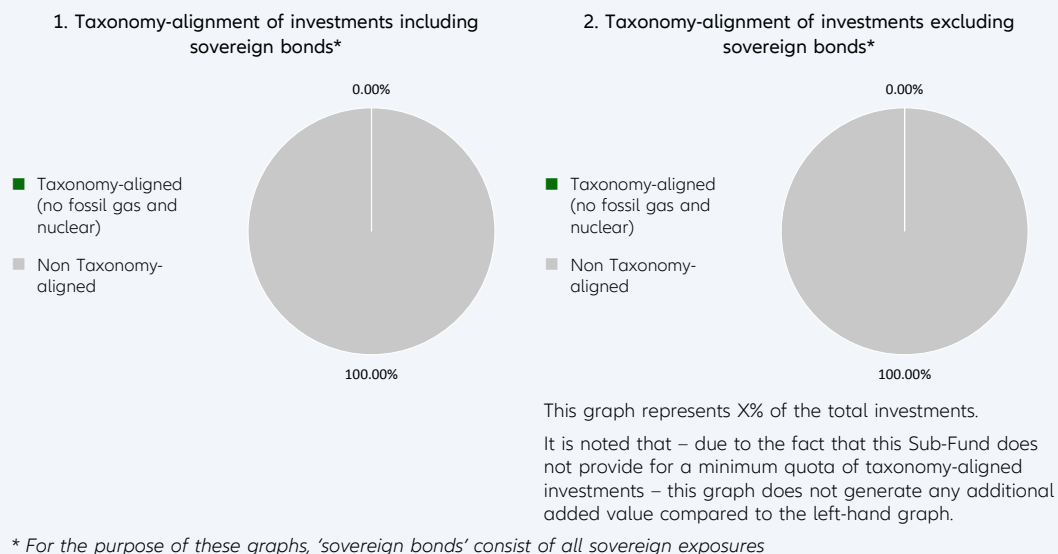

Enabling activities directly enable other activities to make a substantial contribution to an environmental objective.

Transitional activities are activities for which low-carbon alternatives are not yet available and among others have greenhouse gas emission levels corresponding to the best performance.

● **What is the minimum share of investments in transitional and enabling activities?**

The Sub-Fund’s Investment Manager does not commit to a split of minimum taxonomy alignment into transitional, enabling activities and own performance.



What is the minimum share of sustainable investments with an environmental objective that are not aligned with the EU Taxonomy?

The Sub-Fund’s Investment Manager does not commit to a minimum share of investments with an environmental objective that are not aligned with the EU Taxonomy.



are sustainable investments with an environmental objective that **do not take into account the criteria** for environmentally sustainable economic activities under the EU Taxonomy.



What is the minimum share of socially sustainable investments?

The Sub-Fund’s Investment Manager does not commit to a minimum share of socially sustainable investments.



What investments are included under “#2 Other”, what is their purpose and are there any minimum environmental or social safeguards?

Under “#2 Other” investments into cash, Target Funds, or derivatives can be included. Derivatives might be used for efficient portfolio management (including risk hedging) and/or investment purposes, and Target Funds to benefit from a specific strategy. For those investments no environmental or social safeguards are applied.



Is a specific index designated as a reference benchmark to determine whether this financial product is aligned with the environmental and/or social characteristics that it promotes?

Yes, the Sub-Fund has assigned the MSCI AC World (ACWI) Total Return Net as a benchmark. This benchmark is a market index. The Sub-Fund will promote environmental and social characteristics by outperforming the benchmark's Weighted Average GHG Intensity

Reference benchmarks are indexes to measure whether the financial product attains the environmental or social characteristics that they promote.

- **How is the reference benchmark continuously aligned with each of the environmental or social characteristics promoted by the financial product?**
The benchmark is a market index and does not incorporate environmental or social characteristics for index construction.
- **How is the alignment of the investment strategy with the methodology of the index ensured on a continuous basis?**
The benchmark is not continuously aligned as it does not incorporate environmental or social characteristics for index construction.
- **How does the designated index differ from a relevant broad market index?**
The benchmark is a broad market index.
- **Where can the methodology used for the calculation of the designated index be found?**
Details of the Benchmark's methodology may be found at <https://www.msci.com/our-solutions/indexes/acwi>



Where can I find more product specific information online?

More product-specific information can be found on the website: <https://regulatory.allianzgi.com/SFDR>

Template pre-contractual disclosure for the financial products referred to in Article 8, paragraphs 1, 2 and 2a, of Regulation (EU) 2019/2088 and Article 6, first paragraph, of Regulation (EU) 2020/852

Product name:

Allianz Global Equity Insights

Legal entity identifier: 549300ZVWGJLGIGOEH86

Environmental and/or social characteristics

Sustainable investment means an investment in an economic activity that contributes to an environmental or social objective, provided that the investment does not significantly harm any environmental or social objective and that the investee companies follow good governance practices.

The **EU Taxonomy** is a classification system laid down in Regulation (EU) 2020/852, establishing a list of **environmentally sustainable economic activities**. That Regulation does not include a list of socially sustainable economic activities. Sustainable investments with an environmental objective might be aligned with the Taxonomy or not.

Does this financial product have a sustainable investment objective?	
<input checked="" type="radio"/> <input checked="" type="radio"/> Yes	<input checked="" type="radio"/> <input type="radio"/> No
<input type="checkbox"/> It will make a minimum of sustainable investments with an environmental objective: ___% <ul style="list-style-type: none"> <input type="checkbox"/> in economic activities that qualify as environmentally sustainable under the EU Taxonomy <input type="checkbox"/> in economic activities that do not qualify as environmentally sustainable under the EU Taxonomy 	<input checked="" type="checkbox"/> It promotes Environmental/Social (E/S) characteristics and while it does not have as its objective a sustainable investment, it will have a minimum proportion of 10.00% of sustainable investments <ul style="list-style-type: none"> <input checked="" type="checkbox"/> with an environmental objective in economic activities that qualify as environmentally sustainable under the EU Taxonomy <input checked="" type="checkbox"/> with an environmental objective in economic activities that do not qualify as environmentally sustainable under the EU Taxonomy <input checked="" type="checkbox"/> with a social objective
<input type="checkbox"/> It will make a minimum of sustainable investments with a social objective ___%	<input type="checkbox"/> It promotes E/S characteristics, but will not make any sustainable investments



What environmental and/or social characteristics are promoted by this financial product?

Allianz Global Equity Insights (the "Sub-Fund") is managed according to the Sustainability Key Performance Indicator Strategy (Absolute) ("KPI Strategy (Absolute)") which addresses greenhouse gas (GHG) Intensity. The "Sustainability KPI" measures the GHG Intensity defined by the weighted average intensity of greenhouse gas emissions based on a company's annual sales ("GHG Intensity").

GHG Intensity will be addressed by ensuring a year-on-year improvement pathway of the weighted average GHG Intensity on portfolio level for the prospective fiscal year ends of the Sub-Fund.

In addition, sustainable minimum exclusion criteria apply.

No reference benchmark has been designated for the purpose of attaining the environmental and/or social characteristics promoted by the Sub-Fund.

● What sustainability indicators are used to measure the attainment of each of the environmental or social characteristics promoted by this financial product?

To measure the attainment of the environmental and/or social characteristics the following sustainability indicators are used and reported on, at the fiscal year end:

- The actual percentage of KPI coverage of the Sub-Fund's Portfolio (Portfolio in this respect does not comprise derivatives and instruments that are non-evaluated by nature (e. g., cash and deposits)).
- The year-on-year improvement pathway of the Sub-Fund's Weighted Average GHG Intensity.

- Confirmation that Principal Adverse Impacts (PAIs) of investment decisions on sustainability factors are considered through the application of exclusion criteria.

- **What are the objectives of the sustainable investments that the financial product partially intends to make and how does the sustainable investment contribute to such objectives?**

Sustainable investments contribute to environmental and/or social objectives, for which the Investment Manager uses as reference frameworks, among others, the UN Sustainable Development Goals (SDGs), as well as the objectives of the EU Taxonomy:

1. Climate Change Mitigation
2. Climate Change Adaptation
3. Sustainable Use and Protection of Water and Marine Resources
4. Transition to a Circular Economy
5. Pollution Prevention and Control
6. Protection and Restoration of Biodiversity and Ecosystems

The assessment of the positive contribution to the environmental or social objectives is based on a proprietary framework which combines quantitative elements with qualitative inputs from internal research. The methodology applies first a quantitative breakdown of a securities issuer into its business activities. The qualitative element of the framework is an assessment if business activities contribute positively to an environmental or a social objective.

To calculate the positive contribution on the Sub-Fund level the revenue share of each issuer attributable to business activities contributing to environmental and/or social objectives is considered provided the issuer is satisfying the Do No Significant Harm (“DNSH”) and Good Governance principles, and an asset-weighted aggregation is performed as a second step. Moreover, for certain types of securities, which finance specific projects contributing to environmental or social objectives the overall investment is considered to contribute to environmental and/or social objectives, but also for these a DNSH as well as a Good Governance check for issuers is performed.

- **How do the sustainable investments that the financial product partially intends to make, not cause significant harm to any environmental or social sustainable investment objective?**

In order to ensure that Sustainable Investments do not significantly harm any other environmental and/or social objective, the Investment Manager is leveraging the PAI indicators, whereby significance thresholds have been defined to identify significantly harmful issuers. Issuers not meeting the significance threshold can be engaged for a limited time period to remediate the adverse impact. Otherwise, if the issuer does not meet the defined significance thresholds twice subsequently or in case of a failed engagement, it does not pass the DNSH assessment. Investments in securities of issuers which do not pass the DNSH assessment are not counted as sustainable investments.

- *How have the indicators for adverse impacts on sustainability factors been taken into account?*

All mandatory PAI indicators are considered either as part of the application of the exclusion criteria or through thresholds on a sectorial or absolute basis. Significance thresholds have been defined and they refer to qualitative or quantitative criteria.

Recognizing the lack of data coverage for some of the PAI indicators equivalent data points are used to assess PAI indicators when applying the DNSH assessment, when relevant, for the following indicators for corporates: share of non-renewable energy consumption and production, activities negatively affecting biodiversity-sensitive areas, emissions to water, lack of processes and compliance mechanisms to monitor compliance with UNGC principles and OECD Guidelines for Multinational Enterprises; for sovereigns: GHG Intensity and investee countries subject to social violations. In case of securities which finance specific projects contributing to environmental or social objectives equivalent data at project level might be used to ensure that Sustainable Investments do not significantly harm any other environmental and/or social objective. The Investment Manager will strive to increase data coverage for PAI indicators with low data coverage by engaging with issuers and data providers. The Investment Manager will regularly evaluate whether the availability of data has increased sufficiently to potentially include assessment of such data in the investment process.

Principal adverse impacts are the most significant negative impacts of investment decisions on sustainability factors relating to environmental, social and employee matters, respect for human rights, anti-corruption and anti-bribery matters.

- *How are the sustainable investments aligned with the OECD Guidelines for Multinational Enterprises and the UN Guiding Principles on Business and Human Rights? Details:*

The Investment Manager's sustainable minimum exclusion list screens out companies based on their involvement in controversial practices against international norms. The core normative framework consists of the Principles of the UN Global Compact, the OECD Guidelines for Multinational Enterprises and the UN Guiding Principles for Business and Human Rights. Securities issued by companies having a severe violation of these frameworks will be restricted from the investment universe.

The EU Taxonomy sets out a "do not significant harm" principle by which Taxonomy-aligned investments should not significantly harm EU Taxonomy objectives and is accompanied by specific EU criteria.

The "do not significant harm" principle applies only to those investments underlying the financial product that take into account the EU criteria for environmentally sustainable economic activities. The investments underlying the remaining portion of this financial product do not take into account the EU criteria for environmentally sustainable economic activities.

Any other sustainable investments must also not significantly harm any environmental or social objectives.



Does this financial product consider principal adverse impacts on sustainability factors?

Yes

No

The Management Company has joined the Net Zero Asset Manager Initiative and considers PAI indicators through stewardship including engagement, both are relevant to mitigate potential adverse impact as a company.

Due to the commitment to the Net Zero Asset Manager Initiative, the Management Company aims to reduce greenhouse gas emissions in partnership with asset owner clients on decarbonisation goals, consistent with an ambition to reach net zero emission by 2050 or sooner across all assets under management. As part of this objective the Management Company will set an interim target for the proportion of assets to be managed in line with the attainment of net zero emissions by 2050 or sooner.

The Sub-Fund's Investment Manager addresses PAI indicators regarding greenhouse gas emission, biodiversity, water, waste as well as social and employee matters for corporate issuers, and, where relevant, the freedom house index is applied to investments in sovereigns. PAI indicators are considered within the Investment Manager's investment process through the means of exclusions as described in the "binding elements" section of the Sub-Fund.

The data coverage for the data required for the PAI indicators is heterogenous. The data coverage related to biodiversity, water and waste is low and the related PAI indicators are considered through exclusion of securities issued by companies having a severe violation / breach of principles and guidelines such as the Principles of the United Nations Global Compact, the OECD Guidelines for Multinational Enterprises, and the United Nations Guiding Principles for Business and Human Rights on the grounds of problematic practices around human rights, labour rights, environment, and corruption issues. Therefore, the Investment Manager will strive to increase data coverage for PAI indicators with low data coverage. The Investment Manager will regularly evaluate whether the availability of data has increased sufficiently to potentially include assessment of such data in the investment process.

Additionally, the Investment manager considers GHG related PAI indicators by ensuring a Weighted Average GHG Intensity improvement pathway. The following PAI indicators are considered:

Applicable to corporate issuers

- GHG Emissions
- Carbon footprint
- GHG Intensity of investee companies
- Exposure to companies active in the fossil fuel sector
- Activities negatively affecting biodiversity-sensitive areas
- Emissions to water
- Hazardous waste ratio
- Violation of UN Global compact principles

- Lack of processes and compliance mechanisms to monitor compliance with UN Global Compact principles
- Board gender diversity
- Exposure to controversial weapons

Applicable to sovereign and supranational issuers

- Investee countries subject to social violations

The information on the PAI indicators will be available in the end-year report of the Sub-Fund.



What investment strategy does this financial product follow?

The investment strategy guides investment decisions based on factors such as investment objectives and risk tolerance.

Allianz Global Equity Insights's investment objective is to invest in global equity markets to achieve a concentrated equity portfolio with a focus on stock selection in accordance with the Sustainability Key Performance Indicator Strategy (Absolute) ("KPI Strategy (Absolute)").

The Sub-Fund's strategy is to achieve, at least, a year-on-year improvement pathway on the Sub-Fund's weighted average Sustainability KPI. The Sustainability KPI measures the GHG Intensity defined by the weighted average intensity of greenhouse gas emissions based on a company's annual sales ("GHG Intensity"). In order to reach this target, the Investment Manager will proceed to yearly checks, comparing the Sub-Fund's Sustainability KPI to the annual improvement pathway (time series) of the Sustainability KPI. The time series will be established at the first day of application of the Sustainability KPI (reference date) using the target annual improvement rate for the prospective fiscal year ends of the Sub-Fund. For each fiscal year end of the time series, the annual improvement rate will be applied to the value of the previous fiscal year end target. For the period between Reference Point and the first fiscal year end a pro rata temporis rate of the annual rate will be applied.

The weighted average GHG Intensity is the weighted average of the Sub-Fund's GHG Intensity (in tCO₂e per Millions of sales). Sales represent company's annual sales. This ratio of GHG normalized by Sales facilitates comparison between companies of different sizes. The metric allows comparing weighted average GHG Intensities of different portfolios to identify portfolios comprised of more GHG-efficient issuers in terms of the issuer's sales. The portfolio weights (and benchmark or universe weights) are rebased such that only issuers with GHG emissions data available are considered in the calculation. GHG represents a respective issuer's greenhouse gas emissions. To determine the GHG Intensity of a company issuer, GHG Intensity data from third party data providers will be used. The GHG intensity is analysed by the Investment Manager and is considered within the securities selection process in order to meet the Sub-Fund Investment objective.

The proportion of assets which do not have a GHG intensity assessment is expected to be low. Examples of instruments not having a GHG intensity assessment are cash and deposits, some Target Funds, and investments for which the GHG intensity is deemed to be not appropriate and/or data is not available.

The Sub-Fund's general investment approach (Sub-Fund's applicable General Asset Class Principles in combination with its individual investment restrictions) is described in the prospectus.

● What are the binding elements of the investment strategy used to select the investments to attain each of the environmental or social characteristics promoted by this financial product?

The binding elements are:

- Min. 80% KPI coverage of the Sub-Fund's Portfolio (Portfolio in this respect does not comprise derivatives and instruments that are non-evaluated by nature (e. g., cash and deposits)).
- At least a 5% year-on-year improvement pathway of the Sub-Fund's Weighted Average GHG Intensity starting at the reference date September 29, 2023. For the period between Reference Point and the first fiscal year end a pro rata temporis rate of the annual rate will be applied.
- Application of the following sustainable minimum exclusion criteria for direct investments:
 - securities issued by companies having a severe violation / breach of principles and guidelines such as the Principles of the United Nations Global Compact, the OECD Guidelines for Multinational Enterprises, and the United Nations Guiding Principles for Business and Human Rights on the grounds of problematic practices around human rights, labour rights, environment, and corruption issues,
 - securities issued by companies involved in controversial weapons (anti-personnel mines, cluster munitions, chemical weapons, biological weapons, depleted uranium, white phosphorus, and nuclear weapons),

- securities issued by companies that derive more than 10% of their revenues from weapons, military equipment, and services,
- securities issued by companies that derive more than 10% of their revenue from thermal coal extraction,
- securities issued by utility companies that generate more than 20% of their revenues from coal,
- securities issued by companies involved in the production of tobacco, and securities issued by companies involved in the distribution of tobacco with more than 5% of their revenues.

Direct investments in sovereign issuers with an insufficient freedom house index score are excluded

The sustainable minimum exclusion criteria are based on information from an external data provider and coded in pre- and post-trade compliance. The review is performed at least half yearly.

● **What is the committed minimum rate to reduce the scope of the investments considered prior to the application of that investment strategy?**

The Sub-Fund does not commit to reduce the scope of the investments by a certain minimum rate.

● **What is the policy to assess good governance practices of the investee companies?**

Good governance principles are considered by screening out companies based on their involvement in controversies around international norms corresponding to the four good governance practices: sound management structures, employee relations, remuneration of staff and tax compliance. Companies having a severe violation in either of those areas will not be investible. For certain cases, flagged issuers shall be on a watch list. These companies will appear on this watch list when the Investment Manager believes that engagement may lead to improvements or when the company is assessed to take remedial actions. Companies on the watch list remain investible unless the Investment Manager believes that the engagement or the remedial actions of the company does not lead to the desired remedy of the severe controversy.

In addition, the Sub-Fund's Investment Manager is committed to actively encourage open dialogues with investee companies on corporate governance, proxy voting and broader sustainability issues in advance of shareholder meetings (regularly for direct investments in shares). The Sub-Fund's Investment Manager's approach to proxy voting and company engagement is set out in the Management Company's Stewardship Statement.

Good governance practices include sound management structures, employee relations, remuneration of staff and tax compliance.



What is the asset allocation planned for this financial product?

Asset allocation describes the share of investments in specific assets.

Min. 80% of the Sub-Funds' assets (excluding cash, and derivatives) are used to meet the environmental or social characteristics promoted by this Sub-Fund. A low portion of the Sub-Fund might contain assets which do not promote environmental or social characteristics. Examples of such instruments are derivatives, cash and deposits, some Target Funds and investment with temporarily divergent or absent environmental, social, or good governance qualifications. Min. 10% of the Sub-Funds' assets will be invested in Sustainable Investments. The minimum percentage of investments that are aligned with the EU Taxonomy is 0.01%. The Sub-Fund's Investment Manager does not commit to a minimum share of environmentally Sustainable Investments that are not aligned with the EU Taxonomy. The Sub-Fund's Investment Manager does not commit to a minimum share of socially sustainable investments. While the Sub-Fund cannot commit to a minimum share of environmentally or socially sustainable investments, such investments may be freely allocated to within the Sub-Fund aggregated sustainable investment commitment disclosed (min 10%).

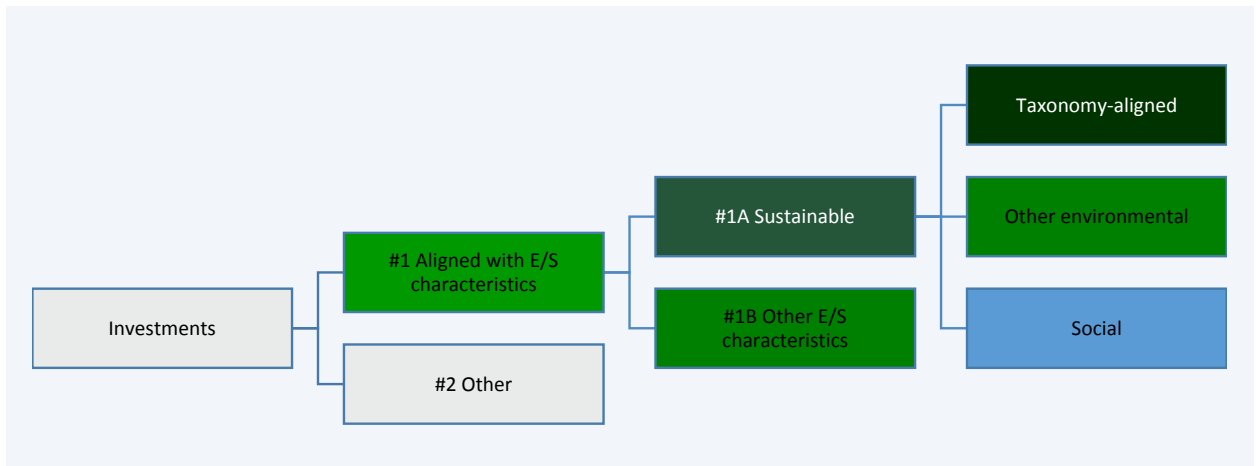

#1 Aligned with E/S characteristics includes the investments of the financial product used to attain the environmental or social characteristics promoted by the financial product.

#2 Other includes the remaining investments of the financial product which are neither aligned with the environmental or social characteristics, nor are qualified as sustainable investments.

The category **#1 Aligned with E/S characteristics** covers:

- The sub-category **#1A Sustainable** covers sustainable investments with environmental or social objectives.
- The sub-category **#1B Other E/S characteristics** covers investments aligned with the environmental or social characteristics that do not qualify as sustainable investments.

- **How does the use of derivatives attain the environmental or social characteristics promoted by the financial product?**

Not applicable



To what minimum extent are sustainable investments with an environmental objective aligned with the EU Taxonomy?

The Taxonomy-aligned investments include debt and/or equity in environmentally sustainable economic activities aligned with the EU-Taxonomy. The minimum percentage of investments that are aligned with the EU Taxonomy is 0.01%. Taxonomy-aligned data is provided by an external data provider. The Investment Manager has assessed the quality of such data. The data will not be subject to an assurance provided by auditors or a review by third parties. The data will not reflect any data in government bonds. As of today, there is no recognized methodology available to determine the proportion of Taxonomy-aligned activities when investing in government bonds.

Taxonomy-aligned activities in this disclosure are based on share of turnover. Pre-contractual figures use turnover as its financial metric as a default in line with the regulatory requirements and based on the fact that complete, verifiable or up-to date data for CAPEX and/or OPEX as financial metric is even less available.

Taxonomy-aligned data is only in rare cases data reported by companies in accordance with the EU Taxonomy. The data provider has derived Taxonomy-aligned data from other available equivalent public data.

- **Does the financial product invest in fossil gas and/or nuclear energy related activities that comply with the EU Taxonomy ¹?**

Yes:

In fossil gas In nuclear energy

No

The Sub-Fund does not pursue any investments in fossil gas and/or nuclear energy related activities that comply with the EU Taxonomy. Nevertheless, as result of this investment strategy, investments may occur in corporates which are also active in these activities. Further information will be provided as part of the annual reporting, if relevant.

Taxonomy-aligned activities are expressed as a share of:

- **turnover** reflecting the share of revenue from green activities of investee companies
- **capital expenditure (CapEx)** showing the green investments made by investee companies, e.g. for a transition to a green

¹ Fossil gas and/or nuclear related activities will only comply with the EU Taxonomy where they contribute to limiting climate change ("climate change mitigation") and do not significantly harm any EU Taxonomy objective - see explanatory note in the left hand margin. The full criteria for fossil gas and nuclear energy economic activities that comply with the EU Taxonomy are laid down in Commission Delegated Regulation (EU) 2022/1214.

economy.
- **operational expenditure** (OpEx) reflecting green operational activities of investee companies.

The two graphs below show in green the minimum percentage of investments that are aligned with the EU Taxonomy. As there is no appropriate methodology to determine the Taxonomy-alignment of sovereign bonds*, the first graph shows the Taxonomy-alignment in relation to all the investments of the financial product including sovereign bonds, while the second graph shows the Taxonomy-alignment only in relation to the investments of the financial product other than sovereign bonds.

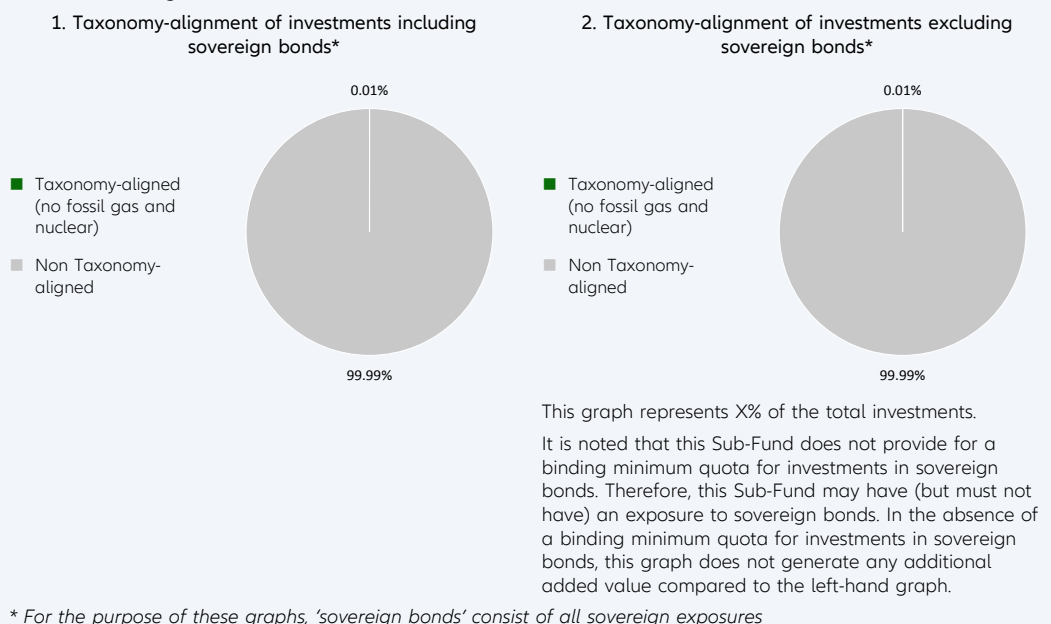

Enabling activities directly enable other activities to make a substantial contribution to an environmental objective.

● **What is the minimum share of investments in transitional and enabling activities?**

The Sub-Fund's Investment Manager does not commit to a split of minimum taxonomy alignment into transitional, enabling activities and own performance.

Transitional activities are activities for which low-carbon alternatives are not yet available and among others have greenhouse gas emission levels corresponding to the best performance.



What is the minimum share of sustainable investments with an environmental objective that are not aligned with the EU Taxonomy?

Taxonomy-aligned investments are considered a sub-category of Sustainable Investments. If an investment is not Taxonomy-aligned since the activity is not yet covered under the EU Taxonomy or the positive contribution is not substantial enough to comply with the Taxonomy technical screening criteria, the investment can still be considered an environmentally Sustainable Investment provided it complies with all criteria. The Investment Manager does not commit to a minimum share of environmentally Sustainable Investments that are not aligned with the EU Taxonomy. The overall sustainable investment share may also include investments with an environmental objective in economic activities that do not qualify as environmentally sustainable under the EU Taxonomy, and while the Sub-Fund cannot commit to a minimum share of environmentally or socially sustainable investments, such investments may be freely allocated to within the Sub-Fund aggregated sustainable investment commitment disclosed (min 10%).



are sustainable investments with an environmental objective that **do not take into account the criteria** for environmentally sustainable economic activities under the EU Taxonomy.



What is the minimum share of socially sustainable investments?

The Investment Manager defines Sustainable Investments based on internal research, which uses, among others, the UN Sustainable Development Goals (SDGs), as well as the objectives of the EU Taxonomy as reference frameworks. The Investment Manager does not commit to a minimum share of socially Sustainable Investments, as the SDGs contain environmental as well as social objectives. The overall sustainable investment share may also include investments with a social objective, and while the Sub-Fund cannot commit to a minimum share of environmentally or socially sustainable investments, such investments may be freely allocated to within the Sub-Fund aggregated sustainable investment commitment disclosed (min 10%).



What investments are included under “#2 Other”, what is their purpose and are there any minimum environmental or social safeguards?

Under “#2 Other” investments into cash, Target Funds, or derivatives can be included. Derivatives might be used for efficient portfolio management (including risk hedging) and/or investment purposes, and Target Funds to benefit from a specific strategy. For those investments no environmental or social safeguards are applied.



Is a specific index designated as a reference benchmark to determine whether this financial product is aligned with the environmental and/or social characteristics that it promotes?

No reference benchmark has been designated for the purpose of attaining the environmental and/or social characteristics promoted by the Sub-Fund.

Reference benchmarks are indexes to measure whether the financial product attains the environmental or social characteristics that they promote.

- **How is the reference benchmark continuously aligned with each of the environmental or social characteristics promoted by the financial product?**
Not applicable
- **How is the alignment of the investment strategy with the methodology of the index ensured on a continuous basis?**
Not applicable
- **How does the designated index differ from a relevant broad market index?**
Not applicable
- **Where can the methodology used for the calculation of the designated index be found?**
Not applicable



Where can I find more product specific information online?

More product-specific information can be found on the website: <https://regulatory.allianzgi.com/SFDR>

Template pre-contractual disclosure for the financial products referred to in Article 8, paragraphs 1, 2 and 2a, of Regulation (EU) 2019/2088 and Article 6, first paragraph, of Regulation (EU) 2020/852

Product name:

Allianz Global Equity Unconstrained

Legal entity identifier: 529900MK0JF6PD64Q806

Environmental and/or social characteristics

Sustainable investment means an investment in an economic activity that contributes to an environmental or social objective, provided that the investment does not significantly harm any environmental or social objective and that the investee companies follow good governance practices.

The EU Taxonomy is a classification system laid down in Regulation (EU) 2020/852, establishing a list of environmentally sustainable economic activities. That Regulation does not include a list of socially sustainable economic activities. Sustainable investments with an environmental objective might be aligned with the Taxonomy or not.

Does this financial product have a sustainable investment objective?	
<input checked="" type="radio"/> <input checked="" type="radio"/> Yes	<input checked="" type="radio"/> <input type="radio"/> No
<input type="checkbox"/> It will make a minimum of sustainable investments with an environmental objective: ___% <ul style="list-style-type: none"> <input type="checkbox"/> in economic activities that qualify as environmentally sustainable under the EU Taxonomy <input type="checkbox"/> in economic activities that do not qualify as environmentally sustainable under the EU Taxonomy 	<input type="checkbox"/> It promotes Environmental/Social (E/S) characteristics and while it does not have as its objective a sustainable investment, it will have a minimum proportion of ___% of sustainable investments <ul style="list-style-type: none"> <input type="checkbox"/> with an environmental objective in economic activities that qualify as environmentally sustainable under the EU Taxonomy <input type="checkbox"/> with an environmental objective in economic activities that do not qualify as environmentally sustainable under the EU Taxonomy <input type="checkbox"/> with a social objective
<input type="checkbox"/> It will make a minimum of sustainable investments with a social objective ___%	<input checked="" type="checkbox"/> It promotes E/S characteristics, but will not make any sustainable investments



What environmental and/or social characteristics are promoted by this financial product?

Allianz Global Equity Unconstrained (the "Sub-Fund") is managed according to the Sustainability Key Performance Indicator Strategy (Relative) ("KPI Strategy (Relative)") which addresses greenhouse gas (GHG) Intensity. The "Sustainability KPI" measures the GHG Intensity defined by the weighted average intensity of greenhouse gas emissions based on company's annual sales ("GHG Intensity").

GHG Intensity will be addressed by outperforming the Weighted Average GHG Intensity against its benchmark.

In addition, sustainable minimum exclusion criteria apply.

A reference benchmark has been designated for the purpose of attaining the environmental and/or social characteristics promoted by the Sub-Fund.

● What sustainability indicators are used to measure the attainment of each of the environmental or social characteristics promoted by this financial product?

To measure the attainment of the environmental and/or social characteristics the following sustainability indicators are used and reported on, at the fiscal year end:

- The actual percentage of KPI coverage of the Sub-Fund's Portfolio (Portfolio in this respect does not comprise derivatives and instruments that are non-evaluated by nature (e. g., cash and deposits)).
- The actual weighted average GHG Intensity portfolio vs weighted average GHG Intensity of the benchmark.

Sustainability indicators measure how the environmental or social characteristics promoted by the financial product are attained.

- Confirmation that Principal Adverse Impacts (PAIs) of investment decisions on sustainability factors are considered through the application of exclusion criteria.

- **What are the objectives of the sustainable investments that the financial product partially intends to make and how does the sustainable investment contribute to such objectives?**

Not applicable

- **How do the sustainable investments that the financial product partially intends to make, not cause significant harm to any environmental or social sustainable investment objective?**

Not applicable

- *How have the indicators for adverse impacts on sustainability factors been taken into account?*

Not applicable

- *How are the sustainable investments aligned with the OECD Guidelines for Multinational Enterprises and the UN Guiding Principles on Business and Human Rights? Details:*

Not applicable

Principal adverse impacts are the most significant negative impacts of investment decisions on sustainability factors relating to environmental, social and employee matters, respect for human rights, anti-corruption and anti-bribery matters.



Does this financial product consider principal adverse impacts on sustainability factors?

Yes

No

The Management Company has joined the Net Zero Asset Manager Initiative and considers PAI indicators through stewardship including engagement, both are relevant to mitigate potential adverse impact as a company.

Due to the commitment to the Net Zero Asset Manager Initiative, the Management Company aims to reduce greenhouse gas emissions in partnership with asset owner clients on decarbonisation goals, consistent with an ambition to reach net zero emission by 2050 or sooner across all assets under management. As part of this objective the Management Company will set an interim target for the proportion of assets to be managed in line with the attainment of net zero emissions by 2050 or sooner.

The Sub-Fund's Investment Manager addresses PAI indicators regarding greenhouse gas emission, biodiversity, water, waste as well as social and employee matters for corporate issuers, and, where relevant, the freedom house index is applied to investments in sovereigns. PAI indicators are considered within the Investment Manager's investment process through the means of exclusions as described in the "binding elements" section of the Sub-Fund.

The data coverage for the data required for the PAI indicators is heterogenous. The data coverage related to biodiversity, water and waste is low and the related PAI indicators are considered through exclusion of securities issued by companies having a severe violation / breach of principles and guidelines such as the Principles of the United Nations Global Compact, the OECD Guidelines for Multinational Enterprises, and the United Nations Guiding Principles for Business and Human Rights on the grounds of problematic practices around human rights, labour rights, environment, and corruption issues. Therefore, the Investment Manager will strive to increase data coverage for PAI indicators with low data coverage. The Investment Manager will regularly evaluate whether the availability of data has increased sufficiently to potentially include assessment of such data in the investment process.

Additionally, the Investment manager considers GHG related PAI indicators by outperforming the Weighted Average GHG Intensity against its benchmark.

The following PAI indicators are considered:

Applicable to corporate issuers

- GHG Emissions
- Carbon footprint
- GHG Intensity of investee companies
- Exposure to companies active in the fossil fuel sector
- Activities negatively affecting biodiversity-sensitive areas
- Emissions to water
- Hazardous waste ratio
- Violation of UN Global compact principles
- Lack of processes and compliance mechanisms to monitor compliance with UN Global Compact principles
- Board gender diversity
- Exposure to controversial weapons

Applicable to sovereign and supranational issuers

- Investee countries subject to social violations

The information on the PAI indicators will be available in the end-year report of the Sub-Fund.



What investment strategy does this financial product follow?

The investment strategy guides investment decisions based on factors such as investment objectives and risk tolerance.

Allianz Global Equity Unconstrained's investment objective is to invest in global equity markets to achieve a concentrated equity portfolio with a focus on stock selection in accordance with the Sustainability Key Performance Indicator Strategy (Relative) ("KPI Strategy (Relative)").

The Sub-Fund's strategy is to outperform the Weighted Average GHG Intensity against its benchmark. The outperformance is determined as the excess between the Sub-Fund's weighted average GHG Intensity and the Sub-Fund's benchmark Weighted Average GHG Intensity.

The weighted average GHG Intensity is the weighted average of the Sub-Fund's GHG Intensity (in tCO₂e per Millions of sales). Sales represent company's annual sales. This ratio of GHG normalized by Sales facilitates comparison between companies of different sizes. The ratio is in tCO₂e per Millions of sales. The metric allows comparing weighted average GHG Intensities of different portfolios to identify portfolios comprised of more GHG-efficient issuers in terms of the issuer's sales. The portfolio weights (and benchmark or universe weights) are rebased such that only issuers with GHG emissions data available are considered in the calculation. GHG represents a respective issuer's greenhouse gas emissions. To determine the GHG Intensity of a company issuer, GHG Intensity data from third party data providers will be used. The GHG intensity is analysed by the Investment Manager and is considered within the securities selection process in order to meet the Sub-Fund Investment objective.

The proportion of assets which do not have a GHG intensity assessment is expected to be low. Examples of instruments not having a GHG intensity assessment are cash and deposits, some Target Funds, and investments for which the GHG intensity is deemed to be not appropriate and/or data is not available.

The Sub-Fund's general investment approach (Sub-Fund's applicable General Asset Class Principles in combination with its individual investment restrictions) is described in the prospectus.

● What are the binding elements of the investment strategy used to select the investments to attain each of the environmental or social characteristics promoted by this financial product?

The binding elements are:

- Min. 80% KPI coverage of the Sub-Fund's Portfolio (Portfolio in this respect does not comprise derivatives and instruments that are non-evaluated by nature (e. g., cash and deposits)).
- Min. 20% outperformance of benchmark in terms of Weighted Average GHG Intensity.

- Application of the following sustainable minimum exclusion criteria for direct investments:
- securities issued by companies having a severe violation / breach of principles and guidelines such as the Principles of the United Nations Global Compact, the OECD Guidelines for Multinational Enterprises, and the United Nations Guiding Principles for Business and Human Rights on the grounds of problematic practices around human rights, labour rights, environment, and corruption,
- securities issued by companies involved in controversial weapons (anti-personnel mines, cluster munitions, chemical weapons, biological weapons, depleted uranium, white phosphorus, and nuclear weapons),
- securities issued by companies that derive more than 10% of their revenues from weapons, military equipment, and services,
- securities issued by companies that derive more than 10% of their revenue from thermal coal extraction
- securities issued by utility companies that generate more than 20% of their revenues from coal,
- securities issued by companies involved in the production of tobacco, and securities issued by companies involved in the distribution of tobacco with more than 5% of their revenues.

Direct investments in sovereign issuers with an insufficient freedom house index score are excluded.

The sustainable minimum exclusion criteria are based on information from an external data provider and coded in pre- and post-trade compliance. The review is performed at least half yearly.

● **What is the committed minimum rate to reduce the scope of the investments considered prior to the application of that investment strategy?**

The Sub-Fund does not commit to reduce the scope of the investments by a certain minimum rate.

● **What is the policy to assess good governance practices of the investee companies?**

Good governance principles are considered by screening out companies based on their involvement in controversies around international norms corresponding to the four good governance practices: sound management structures, employee relations, remuneration of staff and tax compliance. Companies having a severe violation in either of those areas will not be investible. For certain cases, flagged issuers shall be on a watch list. These companies will appear on this watch list when the Investment Manager believes that engagement may lead to improvements or when the company is assessed to take remedial actions. Companies on the watch list remain investible unless the Investment Manager believes that the engagement or the remedial actions of the company does not lead to the desired remedy of the severe controversy.

In addition, the Sub-Fund's Investment Manager is committed to actively encourage open dialogues with investee companies on corporate governance, proxy voting and broader sustainability issues in advance of shareholder meetings (regularly for direct investments in shares). The Sub-Fund's Investment Manager's approach to proxy voting and company engagement is set out in the Management Company's Stewardship Statement.

 **What is the asset allocation planned for this financial product?**

Min. 80% of the Sub-Funds' assets (excluding cash, and derivatives) are used to meet the environmental or social characteristics promoted by this Sub-Fund. A low portion of the Sub-Fund might contain assets which do not promote environmental or social characteristics. Example of such instruments are derivatives, cash and deposits, some Target Funds and investment with temporarily divergent or absent environmental, social, or good governance qualifications.

Good governance practices include sound management structures, employee relations, remuneration of staff and tax compliance.

Asset allocation describes the share of investments in specific assets.

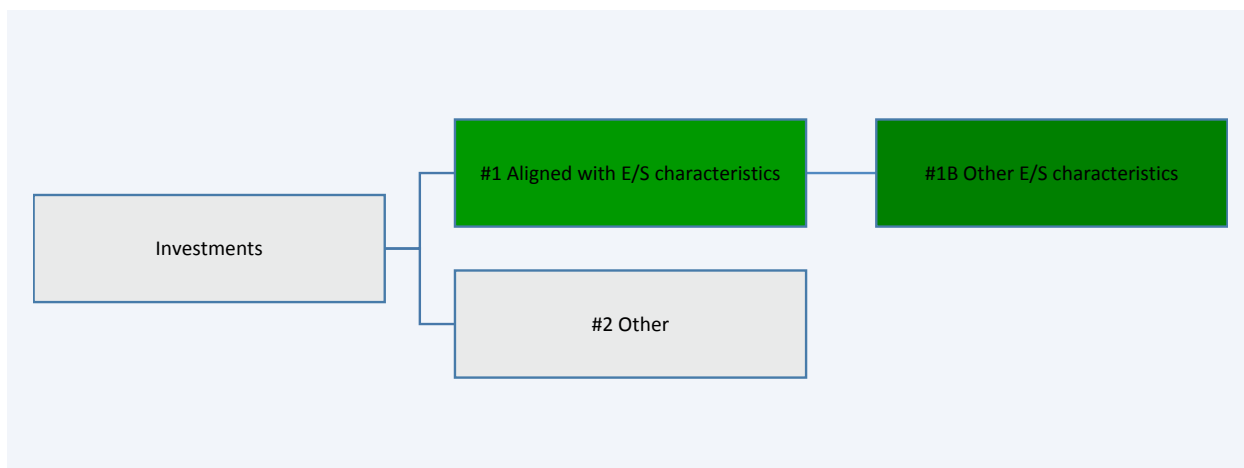

#1 Aligned with E/S characteristics includes the investments of the financial product used to attain the environmental or social characteristics promoted by the financial product.

#2 Other includes the remaining investments of the financial product which are neither aligned with the environmental or social characteristics, nor are qualified as sustainable investments.

The category **#1 Aligned with E/S characteristics** covers:

- The sub-category **#1A Sustainable** covers sustainable investments with environmental or social objectives.
- The sub-category **#1B Other E/S characteristics** covers investments aligned with the environmental or social characteristics that do not qualify as sustainable investments.

- **How does the use of derivatives attain the environmental or social characteristics promoted by the financial product?**

Not applicable



To what minimum extent are sustainable investments with an environmental objective aligned with the EU Taxonomy?

The Sub-Fund's Investment Manager does not commit to a minimum share of sustainable investments with an environmental objective aligned with the EU Taxonomy.

- **Does the financial product invest in fossil gas and/or nuclear energy related activities that comply with the EU Taxonomy¹?**

- Yes:
 - In fossil gas In nuclear energy
- No

Taxonomy-aligned activities are expressed as a share of:

- **turnover** reflecting the share of revenue from green activities of investee companies
- **capital expenditure** (CapEx) showing the green investments made by investee companies, e.g. for a transition to a green economy.
- **operational expenditure** (OpEx) reflecting green operational activities of investee companies.

¹ Fossil gas and/or nuclear related activities will only comply with the EU Taxonomy where they contribute to limiting climate change ("climate change mitigation") and do not significantly harm any EU Taxonomy objective - see explanatory note in the left hand margin. The full criteria for fossil gas and nuclear energy economic activities that comply with the EU Taxonomy are laid down in Commission Delegated Regulation (EU) 2022/1214.

The two graphs below show in green the minimum percentage of investments that are aligned with the EU Taxonomy. As there is no appropriate methodology to determine the Taxonomy-alignment of sovereign bonds*, the first graph shows the Taxonomy-alignment in relation to all the investments of the financial product including sovereign bonds, while the second graph shows the Taxonomy-alignment only in relation to the investments of the financial product other than sovereign bonds.

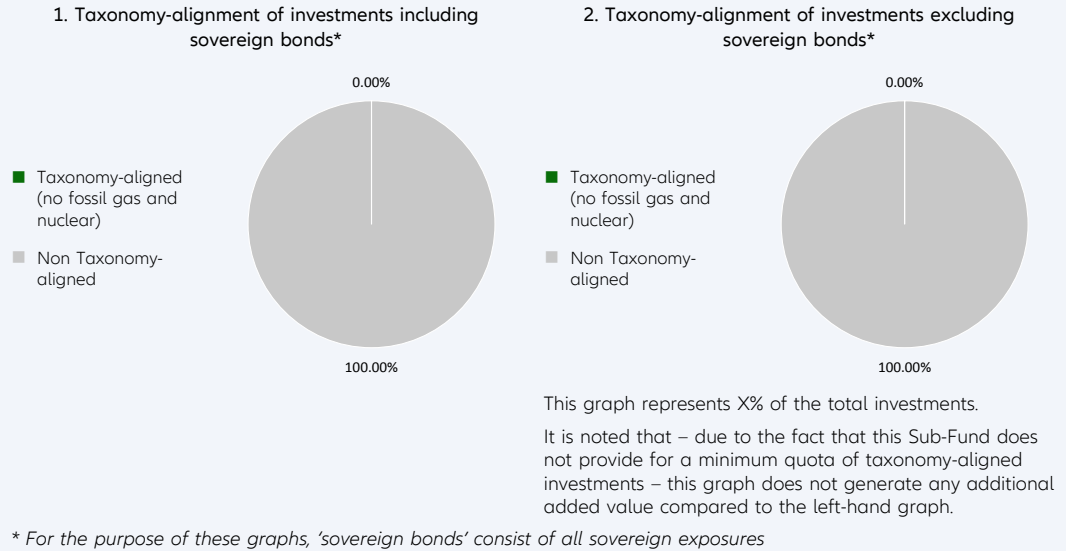

Enabling activities directly enable other activities to make a substantial contribution to an environmental objective.

Transitional activities are activities for which low-carbon alternatives are not yet available and among others have greenhouse gas emission levels corresponding to the best performance.

● **What is the minimum share of investments in transitional and enabling activities?**

The Sub-Fund’s Investment Manager does not commit to a split of minimum taxonomy alignment into transitional, enabling activities and own performance.



What is the minimum share of sustainable investments with an environmental objective that are not aligned with the EU Taxonomy?

The Sub-Fund’s Investment Manager does not commit to a minimum share of investments with an environmental objective that are not aligned with the EU Taxonomy.

 are sustainable investments with an environmental objective that **do not take into account the criteria** for environmentally sustainable economic activities under the EU Taxonomy.



What is the minimum share of socially sustainable investments?

The Sub-Fund’s Investment Manager does not commit to a minimum share of socially sustainable investments.



What investments are included under “#2 Other”, what is their purpose and are there any minimum environmental or social safeguards?

Under “#2 Other” investments into cash, Target Funds, or derivatives can be included. Derivatives might be used for efficient portfolio management (including risk hedging) and/or investment purposes, and Target Funds to benefit from a specific strategy. For those investments no environmental or social safeguards are applied.



Is a specific index designated as a reference benchmark to determine whether this financial product is aligned with the environmental and/or social characteristics that it promotes?

Yes, the Sub-Fund has assigned the MSCI AC World (ACWI) Total Return Net as a benchmark. This benchmark is a market index. The Sub-Fund will promote environmental and social characteristics by outperforming the benchmark's Weighted Average GHG Intensity

Reference benchmarks are indexes to measure whether the financial product attains the environmental or social characteristics that they promote.

- **How is the reference benchmark continuously aligned with each of the environmental or social characteristics promoted by the financial product?**

The benchmark is a market index and does not incorporate environmental or social characteristics for index construction.

- **How is the alignment of the investment strategy with the methodology of the index ensured on a continuous basis?**

The benchmark is not continuously aligned as it does not incorporate environmental or social characteristics for index construction.

- **How does the designated index differ from a relevant broad market index?**

The benchmark is a broad market index.

- **Where can the methodology used for the calculation of the designated index be found?**

Details of the Benchmark's methodology may be found at <https://www.msci.com/our-solutions/indexes/acwi>



Where can I find more product specific information online?

More product-specific information can be found on the website: <https://regulatory.allianzgi.com/SFDR>

Template pre-contractual disclosure for the financial products referred to in Article 8, paragraphs 1, 2 and 2a, of Regulation (EU) 2019/2088 and Article 6, first paragraph, of Regulation (EU) 2020/852

Product name:

Allianz Global Floating Rate Notes Plus

Legal entity identifier: 529900QOOVX41NDJVJ51

Environmental and/or social characteristics

Sustainable investment means an investment in an economic activity that contributes to an environmental or social objective, provided that the investment does not significantly harm any environmental or social objective and that the investee companies follow good governance practices.

The **EU Taxonomy** is a classification system laid down in Regulation (EU) 2020/852, establishing a list of **environmentally sustainable economic activities**. That Regulation does not include a list of socially sustainable economic activities. Sustainable investments with an environmental objective might be aligned with the Taxonomy or not.

Does this financial product have a sustainable investment objective?	
Yes	No
<input type="checkbox"/> It will make a minimum of sustainable investments with an environmental objective: ___% <ul style="list-style-type: none"> <input type="checkbox"/> in economic activities that qualify as environmentally sustainable under the EU Taxonomy <input type="checkbox"/> in economic activities that do not qualify as environmentally sustainable under the EU Taxonomy 	<input checked="" type="checkbox"/> It promotes Environmental/Social (E/S) characteristics and while it does not have as its objective a sustainable investment, it will have a minimum proportion of 5.00% of sustainable investments <ul style="list-style-type: none"> <input checked="" type="checkbox"/> with an environmental objective in economic activities that qualify as environmentally sustainable under the EU Taxonomy <input checked="" type="checkbox"/> with an environmental objective in economic activities that do not qualify as environmentally sustainable under the EU Taxonomy <input checked="" type="checkbox"/> with a social objective
<input type="checkbox"/> It will make a minimum of sustainable investments with a social objective ___%	<input type="checkbox"/> It promotes E/S characteristics, but will not make any sustainable investments



What environmental and/or social characteristics are promoted by this financial product?

Allianz Global Floating Rate Notes Plus (the "Sub-Fund") promotes environmental, social, human rights, governance, and business behaviour factors (this domain does not apply for sovereigns issued by a Sovereign Entity) through integration of a best-in-class approach into the Sub-Fund's investment process. This encompasses the evaluation of corporate or sovereign issuers based on an SRI Rating which is used to construct the portfolio.

In addition, sustainable minimum exclusion criteria apply.

No reference benchmark has been designated for the purpose of attaining the environmental and/or social characteristics promoted by the Sub-Fund.

● What sustainability indicators are used to measure the attainment of each of the environmental or social characteristics promoted by this financial product?

To measure the attainment of the environmental and/or social characteristics the following sustainability indicators are used and reported on, at the fiscal year end:

- The actual percentage of the Sub-Fund's Portfolio (Portfolio in this respect does not comprise non-rated derivatives and instruments that are non-rated by nature (e. g., cash and deposits)) invested in best-in-class issuers (issuers with a minimum SRI Rating of 2 out of a scale from 0-4).
- Confirmation that Principal Adverse Impacts (PAIs) of investment decisions on sustainability factors are considered through the application of exclusion criteria.

Sustainability indicators measure how the environmental or social characteristics promoted by the financial product are attained.

- **What are the objectives of the sustainable investments that the financial product partially intends to make and how does the sustainable investment contribute to such objectives?**

Sustainable investments contribute to environmental and/or social objectives, for which the Investment Manager uses as reference frameworks, among others, the UN Sustainable Development Goals (SDGs), as well as the objectives of the EU Taxonomy:

1. Climate Change Mitigation
2. Climate Change Adaptation
3. Sustainable Use and Protection of Water and Marine Resources
4. Transition to a Circular Economy
5. Pollution Prevention and Control
6. Protection and Restoration of Biodiversity and Ecosystems

The assessment of the positive contribution to the environmental or social objectives is based on a proprietary framework which combines quantitative elements with qualitative inputs from internal research. The methodology applies first a quantitative breakdown of a securities issuer into its business activities. The qualitative element of the framework is an assessment if business activities contribute positively to an environmental or a social objective.

To calculate the positive contribution on the Sub-Fund level the revenue share of each issuer attributable to business activities contributing to environmental and/or social objectives is considered provided the issuer is satisfying the Do No Significant Harm ("DNSH") and Good Governance principles, and an asset-weighted aggregation is performed as a second step. Moreover, for certain types of securities, which finance specific projects contributing to environmental or social objectives the overall investment is considered to contribute to environmental and/or social objectives, but also for these a DNSH as well as a Good Governance check for issuers is performed.

- **How do the sustainable investments that the financial product partially intends to make, not cause significant harm to any environmental or social sustainable investment objective?**

In order to ensure that Sustainable Investments do not significantly harm any other environmental and/or social objective, the Investment Manager is leveraging the PAI indicators, whereby significance thresholds have been defined to identify significantly harmful issuers. Issuers not meeting the significance threshold can be engaged for a limited time period to remediate the adverse impact. Otherwise, if the issuer does not meet the defined significance thresholds twice subsequently or in case of a failed engagement, it does not pass the DNSH assessment. Investments in securities of issuers which do not pass the DNSH assessment are not counted as sustainable investments.

- *How have the indicators for adverse impacts on sustainability factors been taken into account?*

All mandatory PAI indicators are considered either as part of the application of the exclusion criteria or through thresholds on a sectorial or absolute basis. Significance thresholds have been defined and they refer to qualitative or quantitative criteria.

Recognizing the lack of data coverage for some of the PAI indicators equivalent data points are used to assess PAI indicators when applying the DNSH assessment, when relevant, for the following indicators for corporates: share of non-renewable energy consumption and production, activities negatively affecting biodiversity-sensitive areas, emissions to water, lack of processes and compliance mechanisms to monitor compliance with UNGC principles and OECD Guidelines for Multinational Enterprises; for sovereigns: GHG Intensity and investee countries subject to social violations. In case of securities which finance specific projects contributing to environmental or social objectives equivalent data at project level might be used to ensure that Sustainable Investments do not significantly harm any other environmental and/or social objective. The Investment Manager will strive to increase data coverage for PAI indicators with low data coverage by engaging with issuers and data providers. The Investment Manager will regularly evaluate whether the availability of data has increased sufficiently to potentially include assessment of such data in the investment process.

- *How are the sustainable investments aligned with the OECD Guidelines for Multinational Enterprises and the UN Guiding Principles on Business and Human Rights? Details:*

The Investment Manager's sustainable minimum exclusion list screens out companies based on their involvement in controversial practices against international norms. The core normative framework consists of the Principles of the UN Global Compact, the OECD Guidelines for Multinational Enterprises

Principal adverse impacts are the most significant negative impacts of investment decisions on sustainability factors relating to environmental, social and employee matters, respect for human rights, anti-corruption and anti-bribery matters.

and the UN Guiding Principles for Business and Human Rights. Securities issued by companies having a severe violation of these frameworks will be restricted from the investment universe.

The EU Taxonomy sets out a “do not significant harm” principle by which Taxonomy-aligned investments should not significantly harm EU Taxonomy objectives and is accompanied by specific EU criteria.

The “do not significant harm” principle applies only to those investments underlying the financial product that take into account the EU criteria for environmentally sustainable economic activities. The investments underlying the remaining portion of this financial product do not take into account the EU criteria for environmentally sustainable economic activities.

Any other sustainable investments must also not significantly harm any environmental or social objectives.



Does this financial product consider principal adverse impacts on sustainability factors?

Yes

No

The Management Company has joined the Net Zero Asset Manager Initiative and considers PAI indicators through stewardship including engagement, both are relevant to mitigate potential adverse impact as a company.

Due to the commitment to the Net Zero Asset Manager Initiative, the Management Company aims to reduce greenhouse gas emissions in partnership with asset owner clients on decarbonisation goals, consistent with an ambition to reach net zero emission by 2050 or sooner across all assets under management. As part of this objective the Management Company will set an interim target for the proportion of assets to be managed in line with the attainment of net zero emissions by 2050 or sooner.

The Sub-Fund’s Investment Manager considers PAI indicators regarding greenhouse gas emission, biodiversity, water, waste as well as social and employee matters for corporate issuers, and, where relevant, the freedom house index is applied to investments in sovereigns. PAI indicators are considered within the Investment Manager’s investment process through the means of exclusions as described in the “binding elements” section of the Sub-Fund.

The data coverage for the data required for the PAI indicators is heterogenous. The data coverage related to biodiversity, water and waste is low and the related PAI indicators are considered through exclusion of securities issued by companies having a severe violation / breach of principles and guidelines such as the Principles of the United Nations Global Compact, the OECD Guidelines for Multinational Enterprises, and the United Nations Guiding Principles for Business and Human Rights on the grounds of problematic practices around human rights, labour rights, environment, and corruption issues. Therefore, the Investment Manager will strive to increase data coverage for PAI indicators with low data coverage. The Investment Manager will regularly evaluate whether the availability of data has increased sufficiently to potentially include assessment of such data in the investment process.

Additionally, PAI indicators are, among other sustainability factors, applied to derive the SRI Rating. The SRI Rating is used for the portfolio construction.

The following PAI indicators are considered:

Applicable to corporate issuers

- GHG Emissions
- Carbon footprint
- GHG Intensity of investee companies
- Exposure to companies active in the fossil fuel sector
- Activities negatively affecting biodiversity-sensitive areas
- Emissions to water
- Hazardous waste ratio
- Violation of UN Global compact principles
- Lack of processes and compliance mechanisms to monitor compliance with UN Global Compact principles
- Board gender diversity
- Exposure to controversial weapons

Applicable to sovereign and supranational issuers

- Investee countries subject to social violations

The information on the PAI indicators will be available in the end-year report of the Sub-Fund.



The investment strategy guides investment decisions based on factors such as investment objectives and risk tolerance.

What investment strategy does this financial product follow?

Allianz Global Floating Rate Notes Plus' investment objective is to capture income from a global universe of floating-rate notes in accordance with the Sustainable and Responsible Investment Strategy (SRI Strategy).

As part of the SRI best-in-class approach, the Sub-Fund takes environmental, social, human rights, governance, and business behaviour factors into account as follows:

- The aforesaid sustainability factors are analysed through SRI Research by the Investment Manager in order to assess how sustainable development and long-term issues are taken into account in the strategy of an issuer. SRI Research means the overall process of identifying potential risks as well as potential opportunities of an investment in securities of an issuer related to the analysis of sustainability factors. SRI Research data combines external research data (which might have some limitations) with internal analyses.
- Based on a combination of the results of the external and/or internal analyses of the sustainability factors, an internal rating is derived monthly (SRI Rating) and is afterwards assigned to a corporate or sovereign issuer.

This internal SRI Rating is used to rank and select or weight securities for the portfolio construction.

The Sub-Fund's general investment approach (Sub-Fund's applicable General Asset Class Principles in combination with its individual investment restrictions) is described in the prospectus.

● What are the binding elements of the investment strategy used to select the investments to attain each of the environmental or social characteristics promoted by this financial product?

The binding elements are:

- Minimum rating coverage: At least 80% Sub-Fund's portfolio is required to have an SRI Rating (Portfolio in this respect does not comprise non-rated derivatives and instruments that are non-rated by nature (e.g., cash and deposits). While most holdings of the Sub-Fund's will have a corresponding SRI Rating some investments cannot be rated according to the SRI Research methodology. Examples of instruments not attaining to the SRI Rating include, but are not limited to cash, deposits, Target Funds, and non-rated investments.
- The rated instruments are adhering to the minimum rating threshold of 1 (out of a rating scale from 0 – 4; 0 being the worst rating and 4 the best rating)
- Application of the following sustainable minimum exclusion criteria for direct investments:
 - securities issued by companies having a severe violation / breach of principles and guidelines such as the Principles of the United Nations Global Compact, the OECD Guidelines for Multinational Enterprises, and the United Nations Guiding Principles for Business and Human Rights on the grounds of problematic practices around human rights, labour rights, environment, and corruption,
 - securities issued by companies involved in controversial weapons (anti-personnel mines, cluster munitions, chemical weapons, biological weapons, depleted uranium, white phosphorus, and nuclear weapons),
 - securities issued by companies that derive more than 10% of their revenues from weapons, military equipment, and services,
 - securities issued by companies that derive more than 10% of their revenue from thermal coal extraction
 - securities issued by utility companies that generate more than 20% of their revenues from coal,
 - securities issued by companies involved in the production of tobacco, and securities issued by companies involved in the distribution of tobacco with more than 5% of their revenues.

Direct investments in sovereign issuers with an insufficient freedom house index score are excluded.

The sustainable minimum exclusion criteria are based on information from an external data provider and coded in pre- and post-trade compliance. The review is performed at least half yearly.

- **What is the committed minimum rate to reduce the scope of the investments considered prior to the application of that investment strategy?**

The Sub-Fund does not commit to reduce the scope of the investments by a certain minimum rate.

- **What is the policy to assess good governance practices of the investee companies?**

Good governance principles are considered by screening out companies based on their involvement in controversies around international norms corresponding to the four good governance practices: sound management structures, employee relations, remuneration of staff and tax compliance. Companies having a severe violation in either of those areas will not be investible. For certain cases, flagged issuers shall be on a watch list. These companies will appear on this watch list when the Investment Manager believes that engagement may lead to improvements or when the company is assessed to take remedial actions. Companies on the watch list remain investible unless the Investment Manager believes that the engagement or the remedial actions of the company does not lead to the desired remedy of the severe controversy.

In addition, the Sub-Fund’s Investment Manager is committed to actively encourage open dialogues with investee companies on corporate governance, proxy voting and broader sustainability issues in advance of shareholder meetings (regularly for direct investments in shares). The Sub-Fund’s Investment Manager’s approach to proxy voting and company engagement is set out in the Management Company’s Stewardship Statement.

Good governance practices include sound management structures, employee relations, remuneration of staff and tax compliance.



What is the asset allocation planned for this financial product?

Asset allocation describes the share of investments in specific assets.

Min. 80% of the Sub-Funds’ assets (excluding cash and non-rated derivatives) are used to meet the environmental or social characteristics promoted by this Sub-Fund. A low portion of the Sub-Fund might contain assets which do not promote environmental or social characteristics. Example of such instruments are derivatives, cash and deposits, some Target Funds and investment with temporarily divergent or absent environmental, social, or good governance qualifications. Min. 5% of the Sub-Funds’ assets will be invested in Sustainable Investments. The minimum percentage of investments that are aligned with the EU Taxonomy is 0.01%. The Sub-Fund’s Investment Manager does not commit to a minimum share of environmentally Sustainable Investments that are not aligned with the EU Taxonomy. The Sub-Fund’s Investment Manager does not commit to a minimum share of socially sustainable investments. While the Sub-Fund cannot commit to a minimum share of environmentally or socially sustainable investments, such investments may be freely allocated to within the Sub-Fund aggregated sustainable investment commitment disclosed (min. 5%).

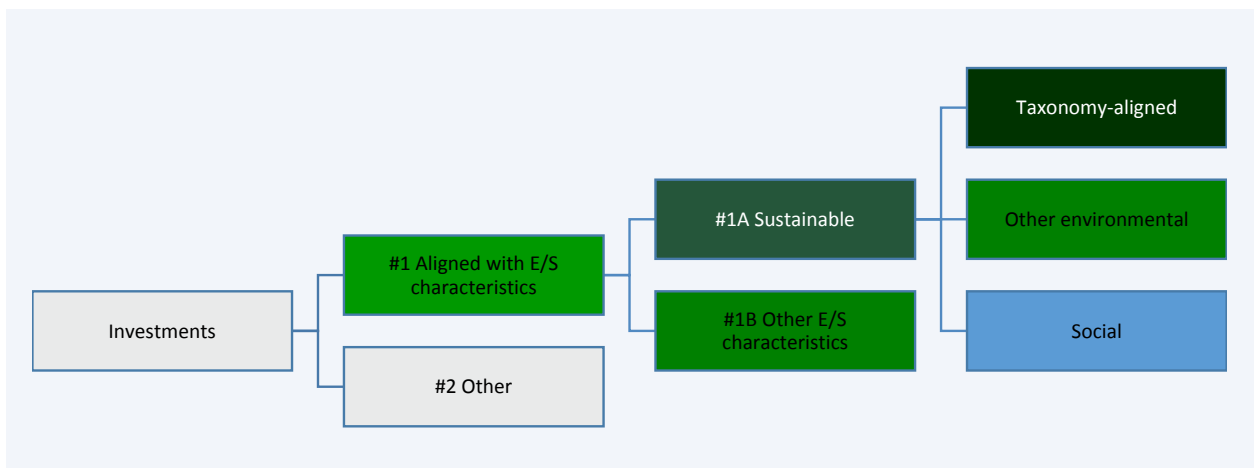

#1 Aligned with E/S characteristics includes the investments of the financial product used to attain the environmental or social characteristics promoted by the financial product.

#2 Other includes the remaining investments of the financial product which are neither aligned with the environmental or social characteristics, nor are qualified as sustainable investments.

The category **#1 Aligned with E/S characteristics** covers:

- The sub-category **#1A Sustainable** covers sustainable investments with environmental or social objectives.
- The sub-category **#1B Other E/S characteristics** covers investments aligned with the environmental or social characteristics that do not qualify as sustainable investments.

- **How does the use of derivatives attain the environmental or social characteristics promoted by the financial product?**

Not applicable



To what minimum extent are sustainable investments with an environmental objective aligned with the EU Taxonomy?

The Taxonomy-aligned investments include debt and/or equity in environmentally sustainable economic activities aligned with the EU-Taxonomy. The minimum percentage of investments that are aligned with the EU Taxonomy is 0.01%. Taxonomy-aligned data is provided by an external data provider. The Investment Manager has assessed the quality of such data. The data will not be subject to an assurance provided by auditors or a review by third parties. The data will not reflect any data in government bonds. As of today, there is no recognized methodology available to determine the proportion of Taxonomy-aligned activities when investing in government bonds.

Taxonomy-aligned activities in this disclosure are based on share of turnover. Pre-contractual figures use turnover as its financial metric as a default in line with the regulatory requirements and based on the fact that complete, verifiable or up-to date data for CAPEX and/or OPEX as financial metric is even less available.

Taxonomy-aligned data is only in rare cases data reported by companies in accordance with the EU Taxonomy. The data provider has derived Taxonomy-aligned data from other available equivalent public data.

- **Does the financial product invest in fossil gas and/or nuclear energy related activities that comply with the EU Taxonomy ¹?**

- Yes:
 - In fossil gas
 - In nuclear energy
- No

The Sub-Fund does not pursue any investments in fossil gas and/or nuclear energy related activities that comply with the EU Taxonomy. Nevertheless, as result of this investment strategy, investments may occur in corporates which are also active in these activities. Further information will be provided as part of the annual reporting, if relevant.

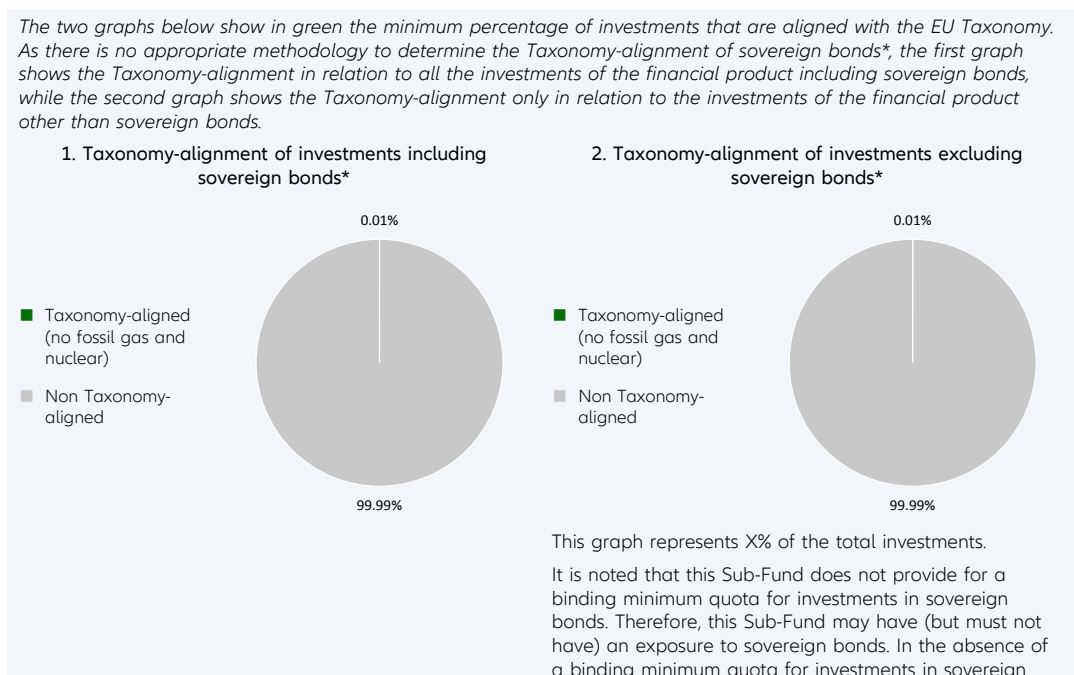

Taxonomy-aligned activities are expressed as a share of:

- **turnover** reflecting the share of revenue from green activities of investee companies
- **capital expenditure (CapEx)** showing the green investments made by investee companies, e.g. for a transition to a green economy.
- **operational expenditure (OpEx)** reflecting green operational activities of investee companies.

¹ Fossil gas and/or nuclear related activities will only comply with the EU Taxonomy where they contribute to limiting climate change ("climate change mitigation") and do not significantly harm any EU Taxonomy objective - see explanatory note in the left hand margin. The full criteria for fossil gas and nuclear energy economic activities that comply with the EU Taxonomy are laid down in Commission Delegated Regulation (EU) 2022/1214.

bonds, this graph does not generate any additional added value compared to the left-hand graph.

* For the purpose of these graphs, 'sovereign bonds' consist of all sovereign exposures

Enabling activities directly enable other activities to make a substantial contribution to an environmental objective.

Transitional activities are activities for which low-carbon alternatives are not yet available and among others have greenhouse gas emission levels corresponding to the best performance.

● **What is the minimum share of investments in transitional and enabling activities?**

The Sub-Fund's Investment Manager does not commit to a split of minimum taxonomy alignment into transitional, enabling activities and own performance.



What is the minimum share of sustainable investments with an environmental objective that are not aligned with the EU Taxonomy?

Taxonomy-aligned investments are considered a sub-category of Sustainable Investments. If an investment is not Taxonomy-aligned since the activity is not yet covered under the EU Taxonomy or the positive contribution is not substantial enough to comply with the Taxonomy technical screening criteria, the investment can still be considered an environmentally Sustainable Investment provided it complies with all criteria. The Investment Manager does not commit to a minimum share of environmentally Sustainable Investments that are not aligned with the EU Taxonomy. The overall sustainable investment share may also include investments with an environmental objective in economic activities that do not qualify as environmentally sustainable under the EU Taxonomy, and while the Sub-Fund cannot commit to a minimum share of environmentally or socially sustainable investments, such investments may be freely allocated to within the Sub-Fund aggregated sustainable investment commitment disclosed (min. 5%).



are sustainable investments with an environmental objective that **do not take into account the criteria** for environmentally sustainable economic activities under the EU Taxonomy.



What is the minimum share of socially sustainable investments?

The Investment Manager defines Sustainable Investments based on internal research, which uses, among others, the UN Sustainable Development Goals (SDGs), as well as the objectives of the EU Taxonomy as reference frameworks. The Investment Manager does not commit to a minimum share of socially Sustainable Investments, as the SDGs contain environmental as well as social objectives. The overall sustainable investment share may also include investments with a social objective, and while the Sub-Fund cannot commit to a minimum share of environmentally or socially sustainable investments, such investments may be freely allocated to within the Sub-Fund aggregated sustainable investment commitment disclosed (min. 5%).



What investments are included under “#2 Other”, what is their purpose and are there any minimum environmental or social safeguards?

Under “#2 Other” investments into cash, Target Funds, or derivatives can be included. Derivatives might be used for efficient portfolio management (including risk hedging) and/or investment purposes, and Target Funds to benefit from a specific strategy. For those investments no environmental or social safeguards are applied.



Is a specific index designated as a reference benchmark to determine whether this financial product is aligned with the environmental and/or social characteristics that it promotes?

No reference benchmark has been designated for the purpose of attaining the environmental and/or social characteristics promoted by the Sub-Fund.

Reference benchmarks are indexes to measure whether the financial product attains the environmental or social characteristics that they promote.

- **How is the reference benchmark continuously aligned with each of the environmental or social characteristics promoted by the financial product?**
Not applicable
- **How is the alignment of the investment strategy with the methodology of the index ensured on a continuous basis?**
Not applicable
- **How does the designated index differ from a relevant broad market index?**
Not applicable
- **Where can the methodology used for the calculation of the designated index be found?**
Not applicable



Where can I find more product specific information online?

More product-specific information can be found on the website: <https://regulatory.allianzgi.com/SFDR>

Template pre-contractual disclosure for the financial products referred to in Article 8, paragraphs 1, 2 and 2a, of Regulation (EU) 2019/2088 and Article 6, first paragraph, of Regulation (EU) 2020/852

Product name:

Allianz Global High Yield

Legal entity identifier: 549300Y1G08CCQCSWL61

Environmental and/or social characteristics

Sustainable investment means an investment in an economic activity that contributes to an environmental or social objective, provided that the investment does not significantly harm any environmental or social objective and that the investee companies follow good governance practices.

The EU Taxonomy is a classification system laid down in Regulation (EU) 2020/852, establishing a list of **environmentally sustainable economic activities**. That Regulation does not include a list of socially sustainable economic activities. Sustainable investments with an environmental objective might be aligned with the Taxonomy or not.

Does this financial product have a sustainable investment objective?	
Yes	No
<input type="checkbox"/> It will make a minimum of sustainable investments with an environmental objective : ___% <ul style="list-style-type: none"> <input type="checkbox"/> in economic activities that qualify as environmentally sustainable under the EU Taxonomy <input type="checkbox"/> in economic activities that do not qualify as environmentally sustainable under the EU Taxonomy 	<input checked="" type="checkbox"/> It promotes Environmental/Social (E/S) characteristics and while it does not have as its objective a sustainable investment, it will have a minimum proportion of 5.00% of sustainable investments <ul style="list-style-type: none"> <input checked="" type="checkbox"/> with an environmental objective in economic activities that qualify as environmentally sustainable under the EU Taxonomy <input checked="" type="checkbox"/> with an environmental objective in economic activities that do not qualify as environmentally sustainable under the EU Taxonomy <input checked="" type="checkbox"/> with a social objective
<input type="checkbox"/> It will make a minimum of sustainable investments with a social objective ___%	<input type="checkbox"/> It promotes E/S characteristics, but will not make any sustainable investments



What environmental and/or social characteristics are promoted by this financial product?

Allianz Global High Yield (the "Sub-Fund") is managed according to the Sustainability Key Performance Indicator Strategy (Relative) ("KPI Strategy (Relative)") which addresses greenhouse gas (GHG) Intensity. The "Sustainability KPI" measures the GHG Intensity defined by the weighted average intensity of greenhouse gas emissions based on company's annual sales ("GHG Intensity").

GHG Intensity will be addressed by outperforming the Weighted Average GHG Intensity against its benchmark.

In addition, sustainable minimum exclusion criteria apply.

A reference benchmark has been designated for the purpose of attaining the environmental and/or social characteristics promoted by the Sub-Fund.

● What sustainability indicators are used to measure the attainment of each of the environmental or social characteristics promoted by this financial product?

To measure the attainment of the environmental and/or social characteristics the following sustainability indicators are used and reported on, at the fiscal year end:

- The actual percentage of KPI coverage of the Sub-Fund's Portfolio (Portfolio in this respect does not comprise derivatives and instruments that are non-evaluated by nature (e. g., cash and deposits)).
- The actual weighted average GHG Intensity portfolio vs weighted average GHG Intensity of the benchmark.

Sustainability indicators measure how the environmental or social characteristics promoted by the financial product are attained.

- Confirmation that Principal adverse impacts (PAIs) of investment decisions on sustainability factors are considered through the application of exclusion criteria.

- **What are the objectives of the sustainable investments that the financial product partially intends to make and how does the sustainable investment contribute to such objectives?**

Sustainable investments contribute to environmental and/or social objectives, for which the Investment Manager uses as reference frameworks, among others, the UN Sustainable Development Goals (SDGs), as well as the objectives of the EU Taxonomy:

1. Climate Change Mitigation
2. Climate Change Adaptation
3. Sustainable Use and Protection of Water and Marine Resources
4. Transition to a Circular Economy
5. Pollution Prevention and Control
6. Protection and Restoration of Biodiversity and Ecosystems

The assessment of the positive contribution to the environmental or social objectives is based on a proprietary framework which combines quantitative elements with qualitative inputs from internal research. The methodology applies first a quantitative breakdown of a securities issuer into its business activities. The qualitative element of the framework is an assessment if business activities contribute positively to an environmental or a social objective.

To calculate the positive contribution on the Sub-Fund level the revenue share of each issuer attributable to business activities contributing to environmental and/or social objectives is considered provided the issuer is satisfying the Do No Significant Harm (“DNSH”) and Good Governance principles, and an asset-weighted aggregation is performed as a second step. Moreover, for certain types of securities, which finance specific projects contributing to environmental or social objectives the overall investment is considered to contribute to environmental and/or social objectives, but also for these a DNSH as well as a Good Governance check for issuers is performed.

- **How do the sustainable investments that the financial product partially intends to make, not cause significant harm to any environmental or social sustainable investment objective?**

In order to ensure that Sustainable Investments do not significantly harm any other environmental and/or social objective, the Investment Manager is leveraging the PAI indicators, whereby significance thresholds have been defined to identify significantly harmful issuers. Issuers not meeting the significance threshold can be engaged for a limited time period to remediate the adverse impact. Otherwise, if the issuer does not meet the defined significance thresholds twice subsequently or in case of a failed engagement, it does not pass the DNSH assessment. Investments in securities of issuers which do not pass the DNSH assessment are not counted as sustainable investments.

- *How have the indicators for adverse impacts on sustainability factors been taken into account?*

All mandatory PAI indicators are considered either as part of the application of the exclusion criteria or through thresholds on a sectorial or absolute basis. Significance thresholds have been defined and they refer to qualitative or quantitative criteria.

Recognizing the lack of data coverage for some of the PAI indicators equivalent data points are used to assess PAI indicators when applying the DNSH assessment, when relevant, for the following indicators for corporates: share of non-renewable energy consumption and production, activities negatively affecting biodiversity-sensitive areas, emissions to water, lack of processes and compliance mechanisms to monitor compliance with UNGC principles and OECD Guidelines for Multinational Enterprises; for sovereigns: GHG Intensity and investee countries subject to social violations. In case of securities which finance specific projects contributing to environmental or social objectives equivalent data at project level might be used to ensure that Sustainable Investments do not significantly harm any other environmental and/or social objective. The Investment Manager will strive to increase data coverage for PAI indicators with low data coverage by engaging with issuers and data providers. The Investment Manager will regularly evaluate whether the availability of data has increased sufficiently to potentially include assessment of such data in the investment process.

Principal adverse impacts are the most significant negative impacts of investment decisions on sustainability factors relating to environmental, social and employee matters, respect for human rights, anti-corruption and anti-bribery matters.

- *How are the sustainable investments aligned with the OECD Guidelines for Multinational Enterprises and the UN Guiding Principles on Business and Human Rights? Details:*

The Investment Manager's sustainable minimum exclusion list screens out companies based on their involvement in controversial practices against international norms. The core normative framework consists of the Principles of the UN Global Compact, the OECD Guidelines for Multinational Enterprises and the UN Guiding Principles for Business and Human Rights. Securities issued by companies having a severe violation of these frameworks will be restricted from the investment universe.

The EU Taxonomy sets out a "do not significant harm" principle by which Taxonomy-aligned investments should not significantly harm EU Taxonomy objectives and is accompanied by specific EU criteria.

The "do not significant harm" principle applies only to those investments underlying the financial product that take into account the EU criteria for environmentally sustainable economic activities. The investments underlying the remaining portion of this financial product do not take into account the EU criteria for environmentally sustainable economic activities.

Any other sustainable investments must also not significantly harm any environmental or social objectives.



Does this financial product consider principal adverse impacts on sustainability factors?

Yes

No

The Management Company has joined the Net Zero Asset Manager Initiative and considers PAI indicators through stewardship including engagement, both are relevant to mitigate potential adverse impact as a company.

Due to the commitment to the Net Zero Asset Manager Initiative, the Management Company aims to reduce greenhouse gas emissions in partnership with asset owner clients on decarbonisation goals, consistent with an ambition to reach net zero emission by 2050 or sooner across all assets under management. As part of this objective the Management Company will set an interim target for the proportion of assets to be managed in line with the attainment of net zero emissions by 2050 or sooner.

The Sub-Fund's Investment Manager addresses PAI indicators regarding greenhouse gas emission, biodiversity, water, waste as well as social and employee matters for corporate issuers, and, where relevant, the freedom house index is applied to investments in sovereigns. PAI indicators are considered within the Investment Manager's investment process through the means of exclusions as described in the "binding elements" section of the Sub-Fund.

The data coverage for the data required for the PAI indicators is heterogenous. The data coverage related to biodiversity, water and waste is low and the related PAI indicators are considered through exclusion of securities issued by companies having a severe violation / breach of principles and guidelines such as the Principles of the United Nations Global Compact, the OECD Guidelines for Multinational Enterprises, and the United Nations Guiding Principles for Business and Human Rights on the grounds of problematic practices around human rights, labour rights, environment, and corruption issues. Therefore, the Investment Manager will strive to increase data coverage for PAI indicators with low data coverage. The Investment Manager will regularly evaluate whether the availability of data has increased sufficiently to potentially include assessment of such data in the investment process.

Additionally, the Investment manager considers GHG related PAI indicators by outperforming the Weighted Average GHG Intensity against its benchmark. The following PAI indicators are considered:

Applicable to corporate issuers

- GHG Emissions
- Carbon footprint
- GHG Intensity of investee companies
- Exposure to companies active in the fossil fuel sector
- Activities negatively affecting biodiversity-sensitive areas
- Emissions to water
- Hazardous waste ratio
- Violation of UN Global compact principles

- Lack of processes and compliance mechanisms to monitor compliance with UN Global Compact principles
- Board gender diversity
- Exposure to controversial weapons

Applicable to sovereign and supranational issuers

- Investee countries subject to social violations

The information on the PAI indicators will be available in the end-year report of the Sub-Fund.



What investment strategy does this financial product follow?

The investment strategy guides investment decisions based on factors such as investment objectives and risk tolerance.

Allianz Global High Yield's investment objective is to invest in high yield rated Debt Securities of global Bond Markets in accordance with the Sustainability Key Performance Indicator Strategy (Relative) ("KPI Strategy (Relative)"). The Sub-Fund's strategy is to outperform the Weighted Average GHG Intensity against its benchmark. The outperformance is determined as the excess between the Sub-Fund's weighted average GHG Intensity and the Sub-Fund's benchmark Weighted Average GHG Intensity.

The weighted average GHG Intensity is the weighted average of the Sub-Fund's GHG Intensity (in tCO₂e per Millions of sales). Sales represent company's annual sales. This ratio of GHG normalized by Sales facilitates comparison between companies of different sizes. The ratio is in tCO₂e per Millions of sales. The metric allows comparing weighted average GHG Intensities of different portfolios to identify portfolios comprised of more GHG-efficient issuers in terms of the issuer's sales. The portfolio weights (and benchmark or universe weights) are rebased such that only issuers with GHG emissions data available are considered in the calculation. GHG represents a respective issuer's greenhouse gas emissions. To determine the GHG Intensity of a company issuer, GHG Intensity data from third party data providers will be used. The GHG intensity is analysed by the Investment Manager and is considered within the securities selection process in order to meet the Sub-Fund Investment objective.

The proportion of assets which do not have a GHG intensity assessment is expected to be low. Examples of instruments not having a GHG intensity assessment are cash and deposits, some Target Funds, and investments for which the GHG intensity is deemed to be not appropriate and/or data is not available.

The Sub-Fund's general investment approach (Sub-Fund's applicable General Asset Class Principles in combination with its individual investment restrictions) is described in the prospectus.

● What are the binding elements of the investment strategy used to select the investments to attain each of the environmental or social characteristics promoted by this financial product?

The binding elements are:

- Min. 80% KPI coverage of the Sub-Fund's Portfolio (Portfolio in this respect does not comprise derivatives and instruments that are non-evaluated by nature (e. g., cash and deposits)).
- Min. 20% outperformance of benchmark in terms of Weighted Average GHG Intensity.
- Application of the following sustainable minimum exclusion criteria for direct investments:
 - securities issued by companies having a severe violation / breach of principles and guidelines such as the Principles of the United Nations Global Compact, the OECD Guidelines for Multinational Enterprises, and the United Nations Guiding Principles for Business and Human Rights on the grounds of problematic practices around human rights, labour rights, environment, and corruption issues,
 - securities issued by companies involved in controversial weapons (anti-personnel mines, cluster munitions, chemical weapons, biological weapons, depleted uranium, white phosphorus, and nuclear weapons),
 - securities issued by companies that derive more than 10% of their revenues from weapons, military equipment, and services,
 - securities issued by companies that derive more than 10% of their revenue from thermal coal extraction,
 - securities issued by utility companies that generate more than 20% of their revenues from coal,
 - securities issued by companies involved in the production of tobacco, and securities issued by companies involved in the distribution of tobacco with more than 5% of their revenues.

Direct investments in sovereign issuers with an insufficient freedom house index score are excluded.

The sustainable minimum exclusion criteria are based on information from an external data provider and coded in pre- and post-trade compliance. The review is performed at least half yearly.

● **What is the committed minimum rate to reduce the scope of the investments considered prior to the application of that investment strategy?**

The Sub-Fund does not commit to reduce the scope of the investments by a certain minimum rate.

● **What is the policy to assess good governance practices of the investee companies?**

Good governance principles are considered by screening out companies based on their involvement in controversies around international norms corresponding to the four good governance practices: sound management structures, employee relations, remuneration of staff and tax compliance. Companies having a severe violation in either of those areas will not be investible. For certain cases, flagged issuers shall be on a watch list. These companies will appear on this watch list when the Investment Manager believes that engagement may lead to improvements or when the company is assessed to take remedial actions. Companies on the watch list remain investible unless the Investment Manager believes that the engagement or the remedial actions of the company does not lead to the desired remedy of the severe controversy.

In addition, the Sub-Fund's Investment Manager is committed to actively encourage open dialogues with investee companies on corporate governance, proxy voting and broader sustainability issues in advance of shareholder meetings (regularly for direct investments in shares). The Sub-Fund's Investment Manager's approach to proxy voting and company engagement is set out in the Management Company's Stewardship Statement.

Good governance practices include sound management structures, employee relations, remuneration of staff and tax compliance.



What is the asset allocation planned for this financial product?

Asset allocation describes the share of investments in specific assets.

Min. 80% of the Sub-Funds' assets (excluding cash, and derivatives) are used to meet the environmental or social characteristics promoted by this Sub-Fund. A low portion of the Sub-Fund might contain assets which do not promote environmental or social characteristics. Examples of such instruments are derivatives, cash and deposits, some Target Funds and investment with temporarily divergent or absent environmental, social, or good governance qualifications. Min. 5% of the Sub-Funds' assets will be invested in Sustainable Investments. The minimum percentage of investments that are aligned with the EU Taxonomy is 0.01%. The Sub-Fund's Investment Manager does not commit to a minimum share of environmentally Sustainable Investments that are not aligned with the EU Taxonomy. The Sub-Fund's Investment Manager does not commit to a minimum share of socially sustainable investments. While the Sub-Fund cannot commit to a minimum share of environmentally or socially sustainable investments, such investments may be freely allocated to within the Sub-Fund aggregated sustainable investment commitment disclosed (min. 5%).

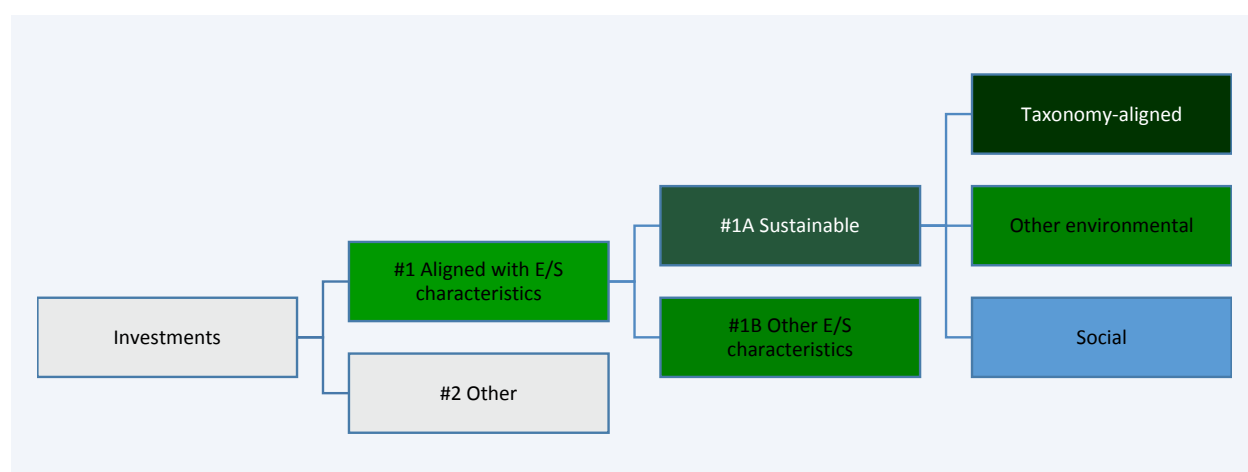

#1 Aligned with E/S characteristics includes the investments of the financial product used to attain the environmental or social characteristics promoted by the financial product.

#2 Other includes the remaining investments of the financial product which are neither aligned with the environmental or social characteristics, nor are qualified as sustainable investments.

The category **#1 Aligned with E/S characteristics** covers:

- The sub-category **#1A Sustainable** covers sustainable investments with environmental or social objectives.
- The sub-category **#1B Other E/S characteristics** covers investments aligned with the environmental or social characteristics that do not qualify as sustainable investments.

- **How does the use of derivatives attain the environmental or social characteristics promoted by the financial product?**

Not applicable



To what minimum extent are sustainable investments with an environmental objective aligned with the EU Taxonomy?

The Taxonomy-aligned investments include debt and/or equity in environmentally sustainable economic activities aligned with the EU-Taxonomy. The minimum percentage of investments that are aligned with the EU Taxonomy is 0.01%. Taxonomy-aligned data is provided by an external data provider. The Investment Manager has assessed the quality of such data. The data will not be subject to an assurance provided by auditors or a review by third parties. The data will not reflect any data in government bonds. As of today, there is no recognized methodology available to determine the proportion of Taxonomy-aligned activities when investing in government bonds.

Taxonomy-aligned activities in this disclosure are based on share of turnover. Pre-contractual figures use turnover as its financial metric as a default in line with the regulatory requirements and based on the fact that complete, verifiable or up-to date data for CAPEX and/or OPEX as financial metric is even less available.

Taxonomy-aligned data is only in rare cases data reported by companies in accordance with the EU Taxonomy. The data provider has derived Taxonomy-aligned data from other available equivalent public data.

- **Does the financial product invest in fossil gas and/or nuclear energy related activities that comply with the EU Taxonomy ¹?**

- Yes:
 - In fossil gas
 - In nuclear energy
- No

The Sub-Fund does not pursue any investments in fossil gas and/or nuclear energy related activities that comply with the EU Taxonomy. Nevertheless, as result of this investment strategy, investments may occur in corporates which are also active in these activities. Further information will be provided as part of the annual reporting, if relevant.

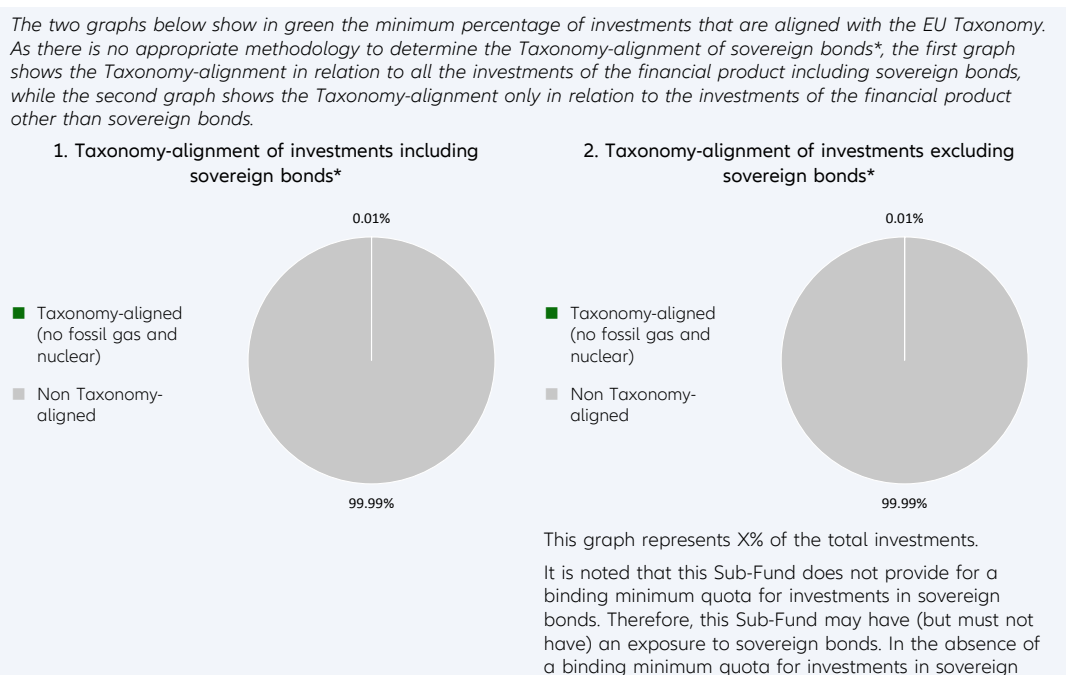

¹ Fossil gas and/or nuclear related activities will only comply with the EU Taxonomy where they contribute to limiting climate change ("climate change mitigation") and do not significantly harm any EU Taxonomy objective - see explanatory note in the left hand margin. The full criteria for fossil gas and nuclear energy economic activities that comply with the EU Taxonomy are laid down in Commission Delegated Regulation (EU) 2022/1214.

bonds, this graph does not generate any additional added value compared to the left-hand graph.

* For the purpose of these graphs, 'sovereign bonds' consist of all sovereign exposures

Enabling activities directly enable other activities to make a substantial contribution to an environmental objective.

Transitional activities are activities for which low-carbon alternatives are not yet available and among others have greenhouse gas emission levels corresponding to the best performance.

● **What is the minimum share of investments in transitional and enabling activities?**

The Sub-Fund's Investment Manager does not commit to a split of minimum taxonomy alignment into transitional, enabling activities and own performance.



What is the minimum share of sustainable investments with an environmental objective that are not aligned with the EU Taxonomy?

Taxonomy-aligned investments are considered a sub-category of Sustainable Investments. If an investment is not Taxonomy-aligned since the activity is not yet covered under the EU Taxonomy or the positive contribution is not substantial enough to comply with the Taxonomy technical screening criteria, the investment can still be considered an environmentally Sustainable Investment provided it complies with all criteria. The Investment Manager does not commit to a minimum share of environmentally Sustainable Investments that are not aligned with the EU Taxonomy. The overall sustainable investment share may also include investments with an environmental objective in economic activities that do not qualify as environmentally sustainable under the EU Taxonomy, and while the Sub-Fund cannot commit to a minimum share of environmentally or socially sustainable investments, such investments may be freely allocated to within the Sub-Fund aggregated sustainable investment commitment disclosed (min. 5%).



are sustainable investments with an environmental objective that **do not take into account the criteria** for environmentally sustainable economic activities under the EU Taxonomy.



What is the minimum share of socially sustainable investments?

The Investment Manager defines Sustainable Investments based on internal research, which uses, among others, the UN Sustainable Development Goals (SDGs), as well as the objectives of the EU Taxonomy as reference frameworks. The Investment Manager does not commit to a minimum share of socially Sustainable Investments, as the SDGs contain environmental as well as social objectives. The overall sustainable investment share may also include investments with a social objective, and while the Sub-Fund cannot commit to a minimum share of environmentally or socially sustainable investments, such investments may be freely allocated to within the Sub-Fund aggregated sustainable investment commitment disclosed (min. 5%).



What investments are included under “#2 Other”, what is their purpose and are there any minimum environmental or social safeguards?

Under “#2 Other” investments into cash, Target Funds, or derivatives can be included. Derivatives might be used for efficient portfolio management (including risk hedging) and/or investment purposes, and Target Funds to benefit from a specific strategy. For those investments no environmental or social safeguards are applied.



Is a specific index designated as a reference benchmark to determine whether this financial product is aligned with the environmental and/or social characteristics that it promotes?

Yes, the Sub-Fund has assigned the ICE BOFAML Global High Yield Constrained (hedged) as a benchmark. This benchmark is a market index. The Sub-Fund will promote environmental and social characteristics by outperforming the benchmark's Weighted Average GHG Intensity

Reference benchmarks are indexes to measure whether the financial product attains the environmental or social characteristics that they promote.

- **How is the reference benchmark continuously aligned with each of the environmental or social characteristics promoted by the financial product?**

The benchmark is a market index and does not incorporate environmental or social characteristics for index construction.

- **How is the alignment of the investment strategy with the methodology of the index ensured on a continuous basis?**

The benchmark is not continuously aligned as it does not incorporate environmental or social characteristics for index construction.

- **How does the designated index differ from a relevant broad market index?**

The benchmark is a broad market index.

- **Where can the methodology used for the calculation of the designated index be found?**

Details of the Benchmark's methodology may be found at <https://www.theice.com/market-data/indices/fixed-income-indices>



Where can I find more product specific information online?

More product-specific information can be found on the website: <https://regulatory.allianzgi.com/SFDR>

Template pre-contractual disclosure for the financial products referred to in Article 8, paragraphs 1, 2 and 2a, of Regulation (EU) 2019/2088 and Article 6, first paragraph, of Regulation (EU) 2020/852

Product name:

Allianz Global Hi-Tech Growth

Legal entity identifier: 529900VB6HV6W8GMHM45

Environmental and/or social characteristics

Sustainable investment means an investment in an economic activity that contributes to an environmental or social objective, provided that the investment does not significantly harm any environmental or social objective and that the investee companies follow good governance practices.

The **EU Taxonomy** is a classification system laid down in Regulation (EU) 2020/852, establishing a list of **environmentally sustainable economic activities**. That Regulation does not include a list of socially sustainable economic activities. Sustainable investments with an environmental objective might be aligned with the Taxonomy or not.

Does this financial product have a sustainable investment objective?	
<input checked="" type="radio"/> <input checked="" type="radio"/> Yes	<input checked="" type="radio"/> <input type="radio"/> No
<input type="checkbox"/> It will make a minimum of sustainable investments with an environmental objective: ___% <ul style="list-style-type: none"> <input type="checkbox"/> in economic activities that qualify as environmentally sustainable under the EU Taxonomy <input type="checkbox"/> in economic activities that do not qualify as environmentally sustainable under the EU Taxonomy 	<input checked="" type="checkbox"/> It promotes Environmental/Social (E/S) characteristics and while it does not have as its objective a sustainable investment, it will have a minimum proportion of 10.00% of sustainable investments <ul style="list-style-type: none"> <input checked="" type="checkbox"/> with an environmental objective in economic activities that qualify as environmentally sustainable under the EU Taxonomy <input checked="" type="checkbox"/> with an environmental objective in economic activities that do not qualify as environmentally sustainable under the EU Taxonomy <input checked="" type="checkbox"/> with a social objective
<input type="checkbox"/> It will make a minimum of sustainable investments with a social objective ___%	<input type="checkbox"/> It promotes E/S characteristics, but will not make any sustainable investments



What environmental and/or social characteristics are promoted by this financial product?

Allianz Global Hi-Tech Growth (the “Sub-Fund”) is managed according to the Sustainability Key Performance Indicator Strategy (Absolute) (“KPI Strategy (Absolute)”) which addresses greenhouse gas (GHG) Intensity. The “Sustainability KPI” measures the GHG Intensity defined by the weighted average intensity of greenhouse gas emissions based on a company’s annual sales (“GHG Intensity”).

GHG Intensity will be addressed by ensuring a year-on-year improvement pathway of the weighted average GHG Intensity on portfolio level for the prospective fiscal year ends of the Sub-Fund.

In addition, sustainable minimum exclusion criteria apply.

No reference benchmark has been designated for the purpose of attaining the environmental and/or social characteristics promoted by the Sub-Fund.

● What sustainability indicators are used to measure the attainment of each of the environmental or social characteristics promoted by this financial product?

To measure the attainment of the environmental and/or social characteristics the following sustainability indicators are used and reported on, at the fiscal year end:

- The actual percentage of KPI coverage of the Sub-Fund’s Portfolio (Portfolio in this respect does not comprise derivatives and instruments that are non-evaluated by nature (e. g., cash and deposits)).
- The year-on-year improvement pathway of the Sub-Fund’s Weighted Average GHG Intensity.

Sustainability indicators measure how the environmental or social characteristics promoted by the financial product are attained.

- Confirmation that Principal Adverse Impacts (PAIs) of investment decisions on sustainability factors are considered through the application of exclusion criteria.

- **What are the objectives of the sustainable investments that the financial product partially intends to make and how does the sustainable investment contribute to such objectives?**

Sustainable investments contribute to environmental and/or social objectives, for which the Investment Manager uses as reference frameworks, among others, the UN Sustainable Development Goals (SDGs), as well as the objectives of the EU Taxonomy:

1. Climate Change Mitigation
2. Climate Change Adaptation
3. Sustainable Use and Protection of Water and Marine Resources
4. Transition to a Circular Economy
5. Pollution Prevention and Control
6. Protection and Restoration of Biodiversity and Ecosystems

The assessment of the positive contribution to the environmental or social objectives is based on a proprietary framework which combines quantitative elements with qualitative inputs from internal research. The methodology applies first a quantitative breakdown of a securities issuer into its business activities. The qualitative element of the framework is an assessment if business activities contribute positively to an environmental or a social objective.

To calculate the positive contribution on the Sub-Fund level the revenue share of each issuer attributable to business activities contributing to environmental and/or social objectives is considered provided the issuer is satisfying the Do No Significant Harm (“DNSH”) and Good Governance principles, and an asset-weighted aggregation is performed as a second step. Moreover, for certain types of securities, which finance specific projects contributing to environmental or social objectives the overall investment is considered to contribute to environmental and/or social objectives, but also for these a DNSH as well as a Good Governance check for issuers is performed.

- **How do the sustainable investments that the financial product partially intends to make, not cause significant harm to any environmental or social sustainable investment objective?**

In order to ensure that Sustainable Investments do not significantly harm any other environmental and/or social objective, the Investment Manager is leveraging the PAI indicators, whereby significance thresholds have been defined to identify significantly harmful issuers. Issuers not meeting the significance threshold can be engaged for a limited time period to remediate the adverse impact. Otherwise, if the issuer does not meet the defined significance thresholds twice subsequently or in case of a failed engagement, it does not pass the DNSH assessment. Investments in securities of issuers which do not pass the DNSH assessment are not counted as sustainable investments.

- *How have the indicators for adverse impacts on sustainability factors been taken into account?*

All mandatory PAI indicators are considered either as part of the application of the exclusion criteria or through thresholds on a sectorial or absolute basis. Significance thresholds have been defined and they refer to qualitative or quantitative criteria.

Recognizing the lack of data coverage for some of the PAI indicators equivalent data points are used to assess PAI indicators when applying the DNSH assessment, when relevant, for the following indicators for corporates: share of non-renewable energy consumption and production, activities negatively affecting biodiversity-sensitive areas, emissions to water, lack of processes and compliance mechanisms to monitor compliance with UNGC principles and OECD Guidelines for Multinational Enterprises; for sovereigns: GHG Intensity and investee countries subject to social violations. In case of securities which finance specific projects contributing to environmental or social objectives equivalent data at project level might be used to ensure that Sustainable Investments do not significantly harm any other environmental and/or social objective. The Investment Manager will strive to increase data coverage for PAI indicators with low data coverage by engaging with issuers and data providers. The Investment Manager will regularly evaluate whether the availability of data has increased sufficiently to potentially include assessment of such data in the investment process.

Principal adverse impacts are the most significant negative impacts of investment decisions on sustainability factors relating to environmental, social and employee matters, respect for human rights, anti-corruption and anti-bribery matters.

- *How are the sustainable investments aligned with the OECD Guidelines for Multinational Enterprises and the UN Guiding Principles on Business and Human Rights? Details:*

The Investment Manager's sustainable minimum exclusion list screens out companies based on their involvement in controversial practices against international norms. The core normative framework consists of the Principles of the UN Global Compact, the OECD Guidelines for Multinational Enterprises and the UN Guiding Principles for Business and Human Rights. Securities issued by companies having a severe violation of these frameworks will be restricted from the investment universe.

The EU Taxonomy sets out a "do not significant harm" principle by which Taxonomy-aligned investments should not significantly harm EU Taxonomy objectives and is accompanied by specific EU criteria.

The "do not significant harm" principle applies only to those investments underlying the financial product that take into account the EU criteria for environmentally sustainable economic activities. The investments underlying the remaining portion of this financial product do not take into account the EU criteria for environmentally sustainable economic activities.

Any other sustainable investments must also not significantly harm any environmental or social objectives.



Does this financial product consider principal adverse impacts on sustainability factors?

Yes

No

The Management Company has joined the Net Zero Asset Manager Initiative and considers PAI indicators through stewardship including engagement, both are relevant to mitigate potential adverse impact as a company.

Due to the commitment to the Net Zero Asset Manager Initiative, the Management Company aims to reduce greenhouse gas emissions in partnership with asset owner clients on decarbonisation goals, consistent with an ambition to reach net zero emission by 2050 or sooner across all assets under management. As part of this objective the Management Company will set an interim target for the proportion of assets to be managed in line with the attainment of net zero emissions by 2050 or sooner.

The Sub-Fund's Investment Manager addresses PAI indicators regarding greenhouse gas emission, biodiversity, water, waste as well as social and employee matters for corporate issuers, and, where relevant, the freedom house index is applied to investments in sovereigns. PAI indicators are considered within the Investment Manager's investment process through the means of exclusions as described in the "binding elements" section of the Sub-Fund.

The data coverage for the data required for the PAI indicators is heterogenous. The data coverage related to biodiversity, water and waste is low and the related PAI indicators are considered through exclusion of securities issued by companies having a severe violation / breach of principles and guidelines such as the Principles of the United Nations Global Compact, the OECD Guidelines for Multinational Enterprises, and the United Nations Guiding Principles for Business and Human Rights on the grounds of problematic practices around human rights, labour rights, environment, and corruption issues. Therefore, the Investment Manager will strive to increase data coverage for PAI indicators with low data coverage. The Investment Manager will regularly evaluate whether the availability of data has increased sufficiently to potentially include assessment of such data in the investment process.

Additionally, the Investment manager considers GHG related PAI indicators by ensuring a Weighted Average GHG Intensity improvement pathway. The following PAI indicators are considered:

Applicable to corporate issuers

- GHG Emissions
- Carbon footprint
- GHG Intensity of investee companies
- Exposure to companies active in the fossil fuel sector
- Activities negatively affecting biodiversity-sensitive areas
- Emissions to water
- Hazardous waste ratio
- Violation of UN Global compact principles

- Lack of processes and compliance mechanisms to monitor compliance with UN Global Compact principles
- Board gender diversity
- Exposure to controversial weapons

Applicable to sovereign and supranational issuers

- Investee countries subject to social violations

The information on the PAI indicators will be available in the end-year report of the Sub-Fund.



What investment strategy does this financial product follow?

The investment strategy guides investment decisions based on factors such as investment objectives and risk tolerance.

Allianz Global Hi-Tech Growth's investment objective is to invest in global equity markets with a focus on the information technology sector or on an industry which forms part of this sector in accordance with the Sustainability Key Performance Indicator Strategy (Absolute) ("KPI Strategy (Absolute)").

The Sub-Fund's strategy is to achieve, at least, a year-on-year improvement pathway on the Sub-Fund's weighted average Sustainability KPI. The Sustainability KPI measures the GHG Intensity defined by the weighted average intensity of greenhouse gas emissions based on a company's annual sales ("GHG Intensity"). In order to reach this target, the Investment Manager will proceed to yearly checks, comparing the Sub-Fund's Sustainability KPI to the annual improvement pathway (time series) of the Sustainability KPI. The time series will be established at the first day of application of the Sustainability KPI (reference date) using the target annual improvement rate for the prospective fiscal year ends of the Sub-Fund. For each fiscal year end of the time series, the annual improvement rate will be applied to the value of the previous fiscal year end target. For the period between Reference Point and the first fiscal year end a pro rata temporis rate of the annual rate will be applied.

The weighted average GHG Intensity is the weighted average of the Sub-Fund's GHG Intensity (in tCO₂e per Millions of sales). Sales represent company's annual sales. This ratio of GHG normalized by Sales facilitates comparison between companies of different sizes. The metric allows comparing weighted average GHG Intensities of different portfolios to identify portfolios comprised of more GHG-efficient issuers in terms of the issuer's sales. The portfolio weights (and benchmark or universe weights) are rebased such that only issuers with GHG emissions data available are considered in the calculation. GHG represents a respective issuer's greenhouse gas emissions. To determine the GHG Intensity of a company issuer, GHG Intensity data from third party data providers will be used. The GHG intensity is analysed by the Investment Manager and is considered within the securities selection process in order to meet the Sub-Fund Investment objective.

The proportion of assets which do not have a GHG intensity assessment is expected to be low. Examples of instruments not having a GHG intensity assessment are cash and deposits, some Target Funds, and investments for which the GHG intensity is deemed to be not appropriate and/or data is not available.

The Sub-Fund's general investment approach (Sub-Fund's applicable General Asset Class Principles in combination with its individual investment restrictions) is described in the prospectus.

● What are the binding elements of the investment strategy used to select the investments to attain each of the environmental or social characteristics promoted by this financial product?

The binding elements are:

- Min. 80% KPI coverage of the Sub-Fund's Portfolio (Portfolio in this respect does not comprise derivatives and instruments that are non-evaluated by nature (e. g., cash and deposits)).
- At least a 5% year-on-year improvement pathway of the Sub-Fund's Weighted Average GHG Intensity starting at the reference date September 29, 2023. For the period between Reference Point and the first fiscal year end a pro rata temporis rate of the annual rate will be applied.
- Application of the following sustainable minimum exclusion criteria for direct investments:
 - securities issued by companies having a severe violation / breach of principles and guidelines such as the Principles of the United Nations Global Compact, the OECD Guidelines for Multinational Enterprises, and the United Nations Guiding Principles for Business and Human Rights on the grounds of problematic practices around human rights, labour rights, environment, and corruption issues,
 - securities issued by companies involved in controversial weapons (anti-personnel mines, cluster munitions, chemical weapons, biological weapons, depleted uranium, white phosphorus, and nuclear weapons),

- securities issued by companies that derive more than 10% of their revenues from weapons, military equipment, and services,
- securities issued by companies that derive more than 10% of their revenue from thermal coal extraction,
- securities issued by utility companies that generate more than 20% of their revenues from coal,
- securities issued by companies involved in the production of tobacco, and securities issued by companies involved in the distribution of tobacco with more than 5% of their revenues.

Direct investments in sovereign issuers with an insufficient freedom house index score are excluded

The sustainable minimum exclusion criteria are based on information from an external data provider and coded in pre- and post-trade compliance. The review is performed at least half yearly.

● **What is the committed minimum rate to reduce the scope of the investments considered prior to the application of that investment strategy?**

The Sub-Fund does not commit to reduce the scope of the investments by a certain minimum rate.

● **What is the policy to assess good governance practices of the investee companies?**

Good governance principles are considered by screening out companies based on their involvement in controversies around international norms corresponding to the four good governance practices: sound management structures, employee relations, remuneration of staff and tax compliance. Companies having a severe violation in either of those areas will not be investible. For certain cases, flagged issuers shall be on a watch list. These companies will appear on this watch list when the Investment Manager believes that engagement may lead to improvements or when the company is assessed to take remedial actions. Companies on the watch list remain investible unless the Investment Manager believes that the engagement or the remedial actions of the company does not lead to the desired remedy of the severe controversy.

In addition, the Sub-Fund's Investment Manager is committed to actively encourage open dialogues with investee companies on corporate governance, proxy voting and broader sustainability issues in advance of shareholder meetings (regularly for direct investments in shares). The Sub-Fund's Investment Manager's approach to proxy voting and company engagement is set out in the Management Company's Stewardship Statement.

Good governance practices include sound management structures, employee relations, remuneration of staff and tax compliance.



What is the asset allocation planned for this financial product?

Asset allocation describes the share of investments in specific assets.

Min. 80% of the Sub-Funds' assets (excluding cash, and derivatives) are used to meet the environmental or social characteristics promoted by this Sub-Fund. A low portion of the Sub-Fund might contain assets which do not promote environmental or social characteristics. Examples of such instruments are derivatives, cash and deposits, some Target Funds and investment with temporarily divergent or absent environmental, social, or good governance qualifications. Min. 10% of the Sub-Funds' assets will be invested in Sustainable Investments. The minimum percentage of investments that are aligned with the EU Taxonomy is 0.01%. The Sub-Fund's Investment Manager does not commit to a minimum share of environmentally Sustainable Investments that are not aligned with the EU Taxonomy. The Sub-Fund's Investment Manager does not commit to a minimum share of socially sustainable investments. While the Sub-Fund cannot commit to a minimum share of environmentally or socially sustainable investments, such investments may be freely allocated to within the Sub-Fund aggregated sustainable investment commitment disclosed (min 10%).

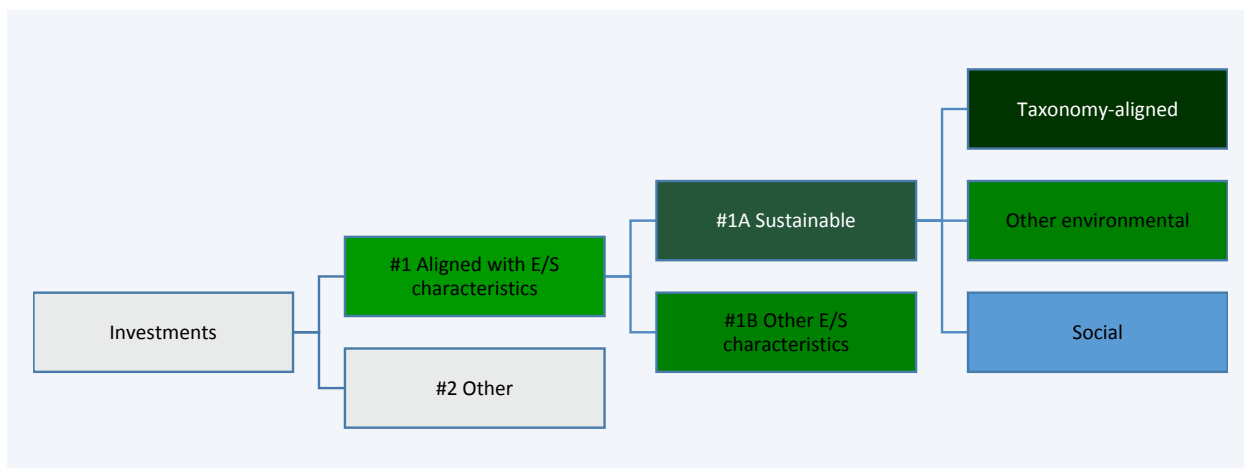

#1 Aligned with E/S characteristics includes the investments of the financial product used to attain the environmental or social characteristics promoted by the financial product.

#2 Other includes the remaining investments of the financial product which are neither aligned with the environmental or social characteristics, nor are qualified as sustainable investments.

The category **#1 Aligned with E/S characteristics** covers:

- The sub-category **#1A Sustainable** covers sustainable investments with environmental or social objectives.
- The sub-category **#1B Other E/S characteristics** covers investments aligned with the environmental or social characteristics that do not qualify as sustainable investments.

● **How does the use of derivatives attain the environmental or social characteristics promoted by the financial product?**

Not applicable



To what minimum extent are sustainable investments with an environmental objective aligned with the EU Taxonomy?

The Taxonomy-aligned investments include debt and/or equity in environmentally sustainable economic activities aligned with the EU-Taxonomy. The minimum percentage of investments that are aligned with the EU Taxonomy is 0.01%. Taxonomy-aligned data is provided by an external data provider. The Investment Manager has assessed the quality of such data. The data will not be subject to an assurance provided by auditors or a review by third parties. The data will not reflect any data in government bonds. As of today, there is no recognized methodology available to determine the proportion of Taxonomy-aligned activities when investing in government bonds.

Taxonomy-aligned activities in this disclosure are based on share of turnover. Pre-contractual figures use turnover as its financial metric as a default in line with the regulatory requirements and based on the fact that complete, verifiable or up-to date data for CAPEX and/or OPEX as financial metric is even less available.

Taxonomy-aligned data is only in rare cases data reported by companies in accordance with the EU Taxonomy. The data provider has derived Taxonomy-aligned data from other available equivalent public data.

● **Does the financial product invest in fossil gas and/or nuclear energy related activities that comply with the EU Taxonomy ¹?**

- Yes:
 - In fossil gas
 - In nuclear energy
- No

The Sub-Fund does not pursue any investments in fossil gas and/or nuclear energy related activities that comply with the EU Taxonomy. Nevertheless, as result of this investment strategy, investments may occur in corporates which are also active in these activities. Further information will be provided as part of the annual reporting, if relevant.

Taxonomy-aligned activities are expressed as a share of:

- **turnover** reflecting the share of revenue from green activities of investee companies
- **capital expenditure (CapEx)** showing the green investments made by investee companies, e.g. for a transition to a green

¹ Fossil gas and/or nuclear related activities will only comply with the EU Taxonomy where they contribute to limiting climate change ("climate change mitigation") and do not significantly harm any EU Taxonomy objective - see explanatory note in the left hand margin. The full criteria for fossil gas and nuclear energy economic activities that comply with the EU Taxonomy are laid down in Commission Delegated Regulation (EU) 2022/1214.

economy.
 - **operational expenditure** (OpEx) reflecting green operational activities of investee companies.

The two graphs below show in green the minimum percentage of investments that are aligned with the EU Taxonomy. As there is no appropriate methodology to determine the Taxonomy-alignment of sovereign bonds*, the first graph shows the Taxonomy-alignment in relation to all the investments of the financial product including sovereign bonds, while the second graph shows the Taxonomy-alignment only in relation to the investments of the financial product other than sovereign bonds.

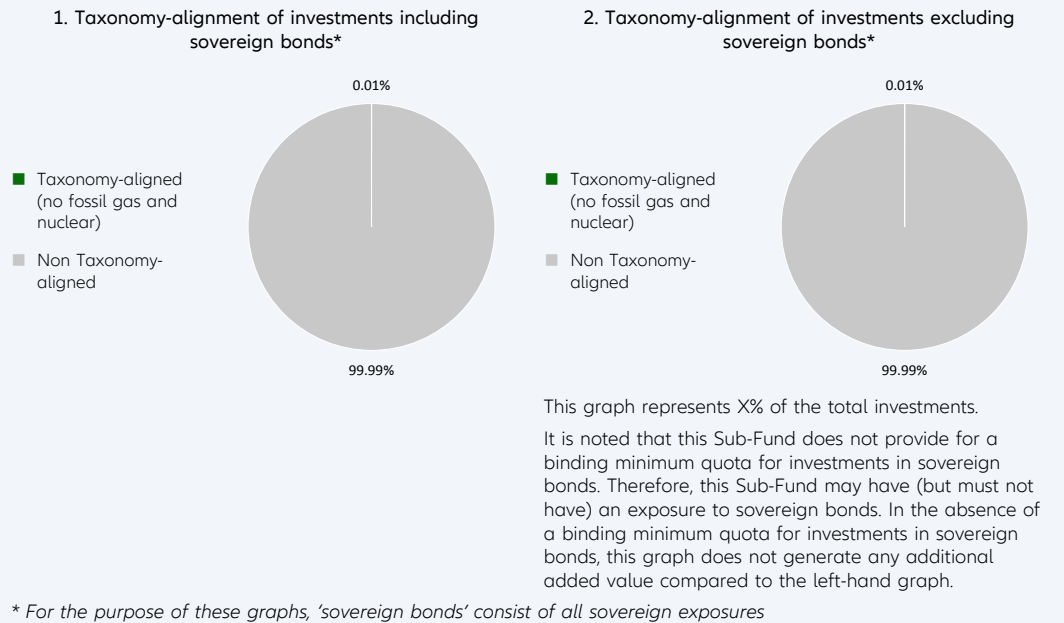

Enabling activities directly enable other activities to make a substantial contribution to an environmental objective.

Transitional activities are activities for which low-carbon alternatives are not yet available and among others have greenhouse gas emission levels corresponding to the best performance.

● **What is the minimum share of investments in transitional and enabling activities?**

The Sub-Fund's Investment Manager does not commit to a split of minimum taxonomy alignment into transitional, enabling activities and own performance.



What is the minimum share of sustainable investments with an environmental objective that are not aligned with the EU Taxonomy?

Taxonomy-aligned investments are considered a sub-category of Sustainable Investments. If an investment is not Taxonomy-aligned since the activity is not yet covered under the EU Taxonomy or the positive contribution is not substantial enough to comply with the Taxonomy technical screening criteria, the investment can still be considered an environmentally Sustainable Investment provided it complies with all criteria. The Investment Manager does not commit to a minimum share of environmentally Sustainable Investments that are not aligned with the EU Taxonomy. The overall sustainable investment share may also include investments with an environmental objective in economic activities that do not qualify as environmentally sustainable under the EU Taxonomy, and while the Sub-Fund cannot commit to a minimum share of environmentally or socially sustainable investments, such investments may be freely allocated to within the Sub-Fund aggregated sustainable investment commitment disclosed (min 10%).

are sustainable investments with an environmental objective that **do not take into account the criteria** for environmentally sustainable economic activities under the EU Taxonomy.



What is the minimum share of socially sustainable investments?

The Investment Manager defines Sustainable Investments based on internal research, which uses, among others, the UN Sustainable Development Goals (SDGs), as well as the objectives of the EU Taxonomy as reference frameworks. The Investment Manager does not commit to a minimum share of socially Sustainable Investments, as the SDGs contain environmental as well as social objectives. The overall sustainable investment share may also include investments with a social objective, and while the Sub-Fund cannot commit to a minimum share of environmentally or socially sustainable investments, such investments may be freely allocated to within the Sub-Fund aggregated sustainable investment commitment disclosed (min 10%).



What investments are included under “#2 Other”, what is their purpose and are there any minimum environmental or social safeguards?

Under “#2 Other” investments into cash, Target Funds, or derivatives can be included. Derivatives might be used for efficient portfolio management (including risk hedging) and/or investment purposes, and Target Funds to benefit from a specific strategy. For those investments no environmental or social safeguards are applied.



Is a specific index designated as a reference benchmark to determine whether this financial product is aligned with the environmental and/or social characteristics that it promotes?

No reference benchmark has been designated for the purpose of attaining the environmental and/or social characteristics promoted by the Sub-Fund.

- How is the reference benchmark continuously aligned with each of the environmental or social characteristics promoted by the financial product?

Not applicable

- How is the alignment of the investment strategy with the methodology of the index ensured on a continuous basis?

Not applicable

- How does the designated index differ from a relevant broad market index?

Not applicable

- Where can the methodology used for the calculation of the designated index be found?

Not applicable

Reference benchmarks are indexes to measure whether the financial product attains the environmental or social characteristics that they promote.



Where can I find more product specific information online?

More product-specific information can be found on the website: <https://regulatory.allianzgi.com/SFDR>

Template pre-contractual disclosure for the financial products referred to in Article 8, paragraphs 1, 2 and 2a, of Regulation (EU) 2019/2088 and Article 6, first paragraph, of Regulation (EU) 2020/852

Product name:

Allianz Global Inflation-Linked Bond

Legal entity identifier: 529900LYBSN4YHEH3K96

Environmental and/or social characteristics

Sustainable investment means an investment in an economic activity that contributes to an environmental or social objective, provided that the investment does not significantly harm any environmental or social objective and that the investee companies follow good governance practices.

The EU Taxonomy is a classification system laid down in Regulation (EU) 2020/852, establishing a list of **environmentally sustainable economic activities**. That Regulation does not include a list of socially sustainable economic activities. Sustainable investments with an environmental objective might be aligned with the Taxonomy or not.

Does this financial product have a sustainable investment objective?

<input checked="" type="radio"/> <input checked="" type="radio"/> Yes		<input checked="" type="radio"/> <input type="radio"/> No	
<input type="checkbox"/> It will make a minimum of sustainable investments with an environmental objective : ___%	<input type="checkbox"/> in economic activities that qualify as environmentally sustainable under the EU Taxonomy	<input type="checkbox"/> in economic activities that do not qualify as environmentally sustainable under the EU Taxonomy	<input type="checkbox"/> It promotes Environmental/Social (E/S) characteristics and while it does not have as its objective a sustainable investment, it will have a minimum proportion of ___% of sustainable investments
<input type="checkbox"/> It will make a minimum of sustainable investments with a social objective ___%	<input type="checkbox"/> with an environmental objective in economic activities that qualify as environmentally sustainable under the EU Taxonomy	<input type="checkbox"/> with an environmental objective in economic activities that do not qualify as environmentally sustainable under the EU Taxonomy	<input type="checkbox"/> with a social objective
<input type="checkbox"/>	<input checked="" type="checkbox"/> It promotes E/S characteristics, but will not make any sustainable investments		



What environmental and/or social characteristics are promoted by this financial product?

Allianz Global Inflation-Linked Bond (the "Sub-Fund") promotes environmental, social, human rights, governance, and business behaviour factors (this domain does not apply for sovereigns issued by a Sovereign Entity) through integration of a best-in-class approach into the Sub-Fund's investment process. This encompasses the evaluation of corporate or sovereign issuers based on an SRI Rating which is used to construct the portfolio.

In addition, sustainable minimum exclusion criteria apply.

No reference benchmark has been designated for the purpose of attaining the environmental and/or social characteristics promoted by the Sub-Fund.

● What sustainability indicators are used to measure the attainment of each of the environmental or social characteristics promoted by this financial product?

To measure the attainment of the environmental and/or social characteristics the following sustainability indicators are used and reported on, at the fiscal year end:

- The actual percentage of the Sub-Fund's Portfolio (Portfolio in this respect does not comprise non-rated derivatives and instruments that are non-rated by nature (e. g., cash and deposits)) assets invested in best-in-class issuers (issuers with a minimum SRI Rating of 2 out of a scale from 0-4; 0 being the worst rating and 4 the best rating) is compared to the actual percentage of the benchmarks best-in-class issuers.
- Confirmation that Principal Adverse Impacts (PAIs) of investment decisions on sustainability factors are considered through the application of exclusion criteria.

Sustainability indicators measure how the environmental or social characteristics promoted by the financial product are attained.

- What are the objectives of the sustainable investments that the financial product partially intends to make and how does the sustainable investment contribute to such objectives?

Not applicable

- How do the sustainable investments that the financial product partially intends to make, not cause significant harm to any environmental or social sustainable investment objective?

Not applicable

- How have the indicators for adverse impacts on sustainability factors been taken into account?

Not applicable

- How are the sustainable investments aligned with the OECD Guidelines for Multinational Enterprises and the UN Guiding Principles on Business and Human Rights? Details:

Not applicable

Principal adverse impacts are the most significant negative impacts of investment decisions on sustainability factors relating to environmental, social and employee matters, respect for human rights, anti-corruption and anti-bribery matters.



Does this financial product consider principal adverse impacts on sustainability factors?

Yes

No

The Management Company has joined the Net Zero Asset Manager Initiative and considers PAI indicators through stewardship including engagement, both are relevant to mitigate potential adverse impact as a company.

Due to the commitment to the Net Zero Asset Manager Initiative, the Management Company aims to reduce greenhouse gas emissions in partnership with asset owner clients on decarbonisation goals, consistent with an ambition to reach net zero emission by 2050 or sooner across all assets under management. As part of this objective the Management Company will set an interim target for the proportion of assets to be managed in line with the attainment of net zero emissions by 2050 or sooner.

The Sub-Fund's Investment Manager considers PAI indicators regarding greenhouse gas emission, biodiversity, water, waste as well as social and employee matters for corporate issuers, and, where relevant, the freedom house index is applied to investments in sovereigns. PAI indicators are considered within the Investment Manager's investment process through the means of exclusions as described in the "binding elements" section of the Sub-Fund.

The data coverage for the data required for the PAI indicators is heterogenous. The data coverage related to biodiversity, water and waste is low and the related PAI indicators are considered through exclusion of securities issued by companies having a severe violation / breach of principles and guidelines such as the Principles of the United Nations Global Compact, the OECD Guidelines for Multinational Enterprises, and the United Nations Guiding Principles for Business and Human Rights on the grounds of problematic practices around human rights, labour rights, environment, and corruption issues. Therefore, the Investment Manager will strive to increase data coverage for PAI indicators with low data coverage. The Investment Manager will regularly evaluate whether the availability of data has increased sufficiently to potentially include assessment of such data in the investment process.

Additionally, PAI indicators are, among other sustainability factors, applied to derive the SRI Rating. The SRI Rating is used for the portfolio construction.

The following PAI indicators are considered:

Applicable to corporate issuers

- GHG Emissions

- Carbon footprint
- GHG Intensity of investee companies
- Exposure to companies active in the fossil fuel sector
- Activities negatively affecting biodiversity-sensitive areas
- Emissions to water
- Hazardous waste ratio
- Violation of UN Global compact principles
- Lack of processes and compliance mechanisms to monitor compliance with UN Global Compact principles
- Board gender diversity
- Exposure to controversial weapons

Applicable to sovereign and supranational issuers

- Investee countries subject to social violations

The information on the PAI indicators will be available in the end-year report of the Sub-Fund.



What investment strategy does this financial product follow?

The investment strategy guides investment decisions based on factors such as investment objectives and risk tolerance.

Allianz Global Inflation-Linked Bond's investment objective is to invest in Debt Securities of global Bond Markets with a focus on inflation-linked bonds in accordance with the Sustainable and Responsible Investment Strategy (SRI Strategy).

As part of the SRI best-in-class approach, the Sub-Fund takes environmental, social, human rights, governance, and business behaviour factors into account as follows:

- The aforesaid sustainability factors are analysed through SRI Research by the Investment Manager in order to assess how sustainable development and long-term issues are taken into account in the strategy of an issuer. SRI Research means the overall process of identifying potential risks as well as potential opportunities of an investment in securities of an issuer related to the analysis of sustainability factors. SRI Research data combines external research data (which might have some limitations) with internal analyses.
- Based on a combination of the results of the external and/or internal analyses of the sustainability factors, an internal rating is derived monthly (SRI Rating) and is afterwards assigned to a corporate or sovereign issuer.

This internal SRI Rating is used to rank and select or weight securities for the portfolio construction.

The Sub-Fund's general investment approach (Sub-Fund's applicable General Asset Class Principles in combination with its individual investment restrictions) is described in the prospectus.

● What are the binding elements of the investment strategy used to select the investments to attain each of the environmental or social characteristics promoted by this financial product?

The binding elements are:

- Minimum rating coverage: At least 90% of the Sub-Fund's portfolio is required to have an SRI Rating (portfolio in this respect does not comprise non-rated derivatives and instruments that are non-rated by nature e.g., cash and deposits). While most holdings of the Sub-Fund will have a corresponding SRI Rating some investments cannot be rated according to the SRI Research methodology. Examples of instruments not attaining to the SRI Rating include, but are not limited to cash, deposits, Target Funds, and non-rated investments.
- 90% of the rated instruments are adhering to the minimum rating threshold of 2 (out of a rating scale from 0 – 4; 0 being the worst rating and 4 the best rating), and 10% are adhering to a rating threshold between 1,5 and 2.
- Application of the following sustainable minimum exclusion criteria for direct investments:
- securities issued by companies having a severe violation / breach of principles and guidelines such as the Principles of the United Nations Global Compact, the OECD Guidelines for Multinational Enterprises, and the United Nations Guiding Principles for Business and Human Rights on the grounds of problematic practices around human rights, labour rights, environment, and corruption issues,

- securities issued by companies involved in controversial weapons (anti-personnel mines, cluster munitions, chemical weapons, biological weapons, depleted uranium, white phosphorus, and nuclear weapons),
- securities issued by companies that derive more than 10% of their revenues from weapons, military equipment, and services,
- securities issued by companies that derive more than 10% of their revenue from thermal coal extraction,
- securities issued by utility companies that generate more than 20% of their revenues from coal,
- securities issued by companies involved in the production of tobacco, and securities issued by companies involved in the distribution of tobacco with more than 5% of their revenues.

Direct investments in sovereign issuers with an insufficient freedom house index score are excluded.

The sustainable minimum exclusion criteria are based on information from an external data provider and coded in pre- and post-trade compliance. The review is performed at least half yearly.

● **What is the committed minimum rate to reduce the scope of the investments considered prior to the application of that investment strategy?**

The Sub-Fund does not commit to reduce the scope of the investments by a certain minimum rate.

● **What is the policy to assess good governance practices of the investee companies?**

Good governance principles are considered by screening out companies based on their involvement in controversies around international norms corresponding to the four good governance practices: sound management structures, employee relations, remuneration of staff and tax compliance. Companies having a severe violation in either of those areas will not be investible. For certain cases, flagged issuers shall be on a watch list. These companies will appear on this watch list when the Investment Manager believes that engagement may lead to improvements or when the company is assessed to take remedial actions. Companies on the watch list remain investible unless the Investment Manager believes that the engagement or the remedial actions of the company does not lead to the desired remedy of the severe controversy.

In addition, the Sub-Fund's Investment Manager is committed to actively encourage open dialogues with investee companies on corporate governance, proxy voting and broader sustainability issues in advance of shareholder meetings (regularly for direct investments in shares). The Sub-Fund's Investment Manager's approach to proxy voting and company engagement is set out in the Management Company's Stewardship Statement.

Good governance practices include sound management structures, employee relations, remuneration of staff and tax compliance.



What is the asset allocation planned for this financial product?

Asset allocation describes the share of investments in specific assets.

Min. 90% of the Sub-Funds' assets (excluding cash and non-rated derivatives) are used to meet the environmental or social characteristics promoted by this Sub-Fund. A low portion of the Sub-Fund might contain assets which do not promote environmental or social characteristics. Examples of such instruments are derivatives, cash and deposits, some Target Funds and investment with temporarily divergent or absent environmental, social, or good governance qualifications.

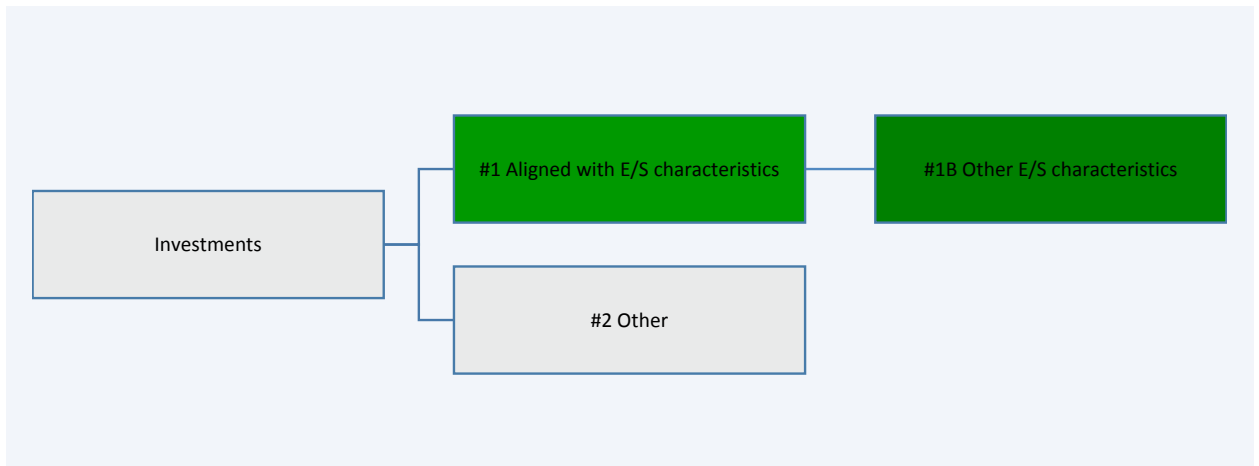

#1 Aligned with E/S characteristics includes the investments of the financial product used to attain the environmental or social characteristics promoted by the financial product.

#2 Other includes the remaining investments of the financial product which are neither aligned with the environmental or social characteristics, nor are qualified as sustainable investments.

The category **#1 Aligned with E/S characteristics** covers:

- The sub-category **#1A Sustainable** covers sustainable investments with environmental or social objectives.
- The sub-category **#1B Other E/S characteristics** covers investments aligned with the environmental or social characteristics that do not qualify as sustainable investments.

- **How does the use of derivatives attain the environmental or social characteristics promoted by the financial product?**

Not applicable



To what minimum extent are sustainable investments with an environmental objective aligned with the EU Taxonomy?

The Sub-Fund's Investment Manager does not commit to a minimum share of sustainable investments with an environmental objective aligned with the EU Taxonomy.

- **Does the financial product invest in fossil gas and/or nuclear energy related activities that comply with the EU Taxonomy¹?**

Yes:

In fossil gas In nuclear energy

No

Taxonomy-aligned activities are expressed as a share of:

- **turnover** reflecting the share of revenue from green activities of investee companies
- **capital expenditure** (CapEx) showing the green investments made by investee companies, e.g. for a transition to a green economy.
- **operational expenditure** (OpEx) reflecting green operational activities of investee companies.

¹ Fossil gas and/or nuclear related activities will only comply with the EU Taxonomy where they contribute to limiting climate change ("climate change mitigation") and do not significantly harm any EU Taxonomy objective - see explanatory note in the left hand margin. The full criteria for fossil gas and nuclear energy economic activities that comply with the EU Taxonomy are laid down in Commission Delegated Regulation (EU) 2022/1214.

The two graphs below show in green the minimum percentage of investments that are aligned with the EU Taxonomy. As there is no appropriate methodology to determine the Taxonomy-alignment of sovereign bonds*, the first graph shows the Taxonomy-alignment in relation to all the investments of the financial product including sovereign bonds, while the second graph shows the Taxonomy-alignment only in relation to the investments of the financial product other than sovereign bonds.

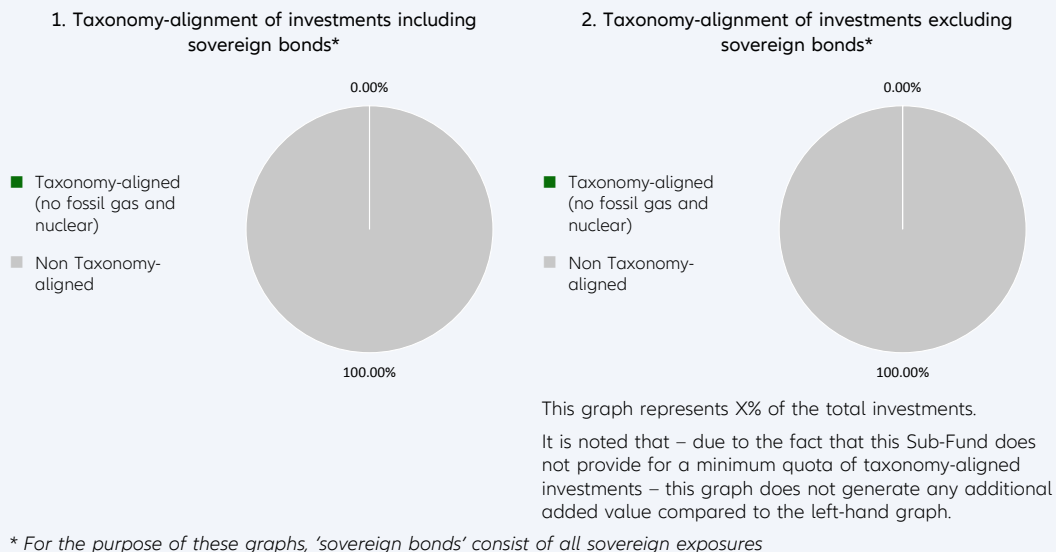

Enabling activities directly enable other activities to make a substantial contribution to an environmental objective.

Transitional activities are activities for which low-carbon alternatives are not yet available and among others have greenhouse gas emission levels corresponding to the best performance.

● **What is the minimum share of investments in transitional and enabling activities?**

The Sub-Fund’s Investment Manager does not commit to a split of minimum taxonomy alignment into transitional, enabling activities and own performance.



What is the minimum share of sustainable investments with an environmental objective that are not aligned with the EU Taxonomy?

The Sub-Fund’s Investment Manager does not commit to a minimum share of investments with an environmental objective that are not aligned with the EU Taxonomy.

 are sustainable investments with an environmental objective that **do not take into account the criteria** for environmentally sustainable economic activities under the EU Taxonomy.



What is the minimum share of socially sustainable investments?

The Sub-Fund’s Investment Manager does not commit to a minimum share of socially sustainable investments.



What investments are included under “#2 Other”, what is their purpose and are there any minimum environmental or social safeguards?

Under “#2 Other” investments into cash, Target Funds, or derivatives can be included. Derivatives might be used for efficient portfolio management (including risk hedging) and/or investment purposes, and Target Funds to benefit from a specific strategy. For those investments no environmental or social safeguards are applied.



Is a specific index designated as a reference benchmark to determine whether this financial product is aligned with the environmental and/or social characteristics that it promotes?

No reference benchmark has been designated for the purpose of attaining the environmental and/or social characteristics promoted by the Sub-Fund.

Reference benchmarks are indexes to measure whether the financial product attains the environmental or social characteristics that they promote.

- How is the reference benchmark continuously aligned with each of the environmental or social characteristics promoted by the financial product?

Not applicable

- How is the alignment of the investment strategy with the methodology of the index ensured on a continuous basis?

Not applicable

- How does the designated index differ from a relevant broad market index?

Not applicable

- Where can the methodology used for the calculation of the designated index be found?

Not applicable



Where can I find more product specific information online?

More product-specific information can be found on the website: <https://regulatory.allianzgi.com/SFDR>

Template pre-contractual disclosure for the financial products referred to in Article 8, paragraphs 1, 2 and 2a, of Regulation (EU) 2019/2088 and Article 6, first paragraph, of Regulation (EU) 2020/852

Product name:

Allianz Global Intelligent Cities Income

Legal entity identifier: 529900FV8TUP35Z9PD66

Environmental and/or social characteristics

Sustainable investment means an investment in an economic activity that contributes to an environmental or social objective, provided that the investment does not significantly harm any environmental or social objective and that the investee companies follow good governance practices.

The EU Taxonomy is a classification system laid down in Regulation (EU) 2020/852, establishing a list of environmentally sustainable economic activities. That Regulation does not include a list of socially sustainable economic activities. Sustainable investments with an environmental objective might be aligned with the Taxonomy or not.

Does this financial product have a sustainable investment objective?	
<input checked="" type="radio"/> <input checked="" type="radio"/> Yes	<input checked="" type="radio"/> <input type="radio"/> No
<input type="checkbox"/> It will make a minimum of sustainable investments with an environmental objective: ___% <ul style="list-style-type: none"> <input type="checkbox"/> in economic activities that qualify as environmentally sustainable under the EU Taxonomy <input type="checkbox"/> in economic activities that do not qualify as environmentally sustainable under the EU Taxonomy 	<input checked="" type="checkbox"/> It promotes Environmental/Social (E/S) characteristics and while it does not have as its objective a sustainable investment, it will have a minimum proportion of 10.00% of sustainable investments <ul style="list-style-type: none"> <input checked="" type="checkbox"/> with an environmental objective in economic activities that qualify as environmentally sustainable under the EU Taxonomy <input checked="" type="checkbox"/> with an environmental objective in economic activities that do not qualify as environmentally sustainable under the EU Taxonomy <input checked="" type="checkbox"/> with a social objective
<input type="checkbox"/> It will make a minimum of sustainable investments with a social objective ___% <ul style="list-style-type: none"> <input type="checkbox"/> in economic activities that qualify as environmentally sustainable under the EU Taxonomy <input type="checkbox"/> in economic activities that do not qualify as environmentally sustainable under the EU Taxonomy 	<input type="checkbox"/> It promotes E/S characteristics, but will not make any sustainable investments <ul style="list-style-type: none"> <input type="checkbox"/> with an environmental objective in economic activities that qualify as environmentally sustainable under the EU Taxonomy <input type="checkbox"/> with an environmental objective in economic activities that do not qualify as environmentally sustainable under the EU Taxonomy <input type="checkbox"/> with a social objective



What environmental and/or social characteristics are promoted by this financial product?

Allianz Global Intelligent Cities Income (the "Sub-Fund") is managed according to the Sustainability Key Performance Indicator Strategy (Relative) ("KPI Strategy (Relative)") which addresses greenhouse gas (GHG) Intensity. The "Sustainability KPI" measures the GHG Intensity defined by the weighted average intensity of greenhouse gas emissions based on company's annual sales ("GHG Intensity").

GHG Intensity will be addressed by outperforming the Weighted Average GHG Intensity against its benchmark.

In addition, sustainable minimum exclusion criteria apply.

A reference benchmark has been designated for the purpose of attaining the environmental and/or social characteristics promoted by the Sub-Fund.

What sustainability indicators are used to measure the attainment of each of the environmental or social characteristics promoted by this financial product?

To measure the attainment of the environmental and/or social characteristics the following sustainability indicators are used and reported on, at the fiscal year end:

- The actual percentage of KPI coverage of the Sub-Fund's Portfolio (Portfolio in this respect does not comprise derivatives and instruments that are non-evaluated by nature (e. g., cash and deposits)).
- The actual weighted average GHG Intensity portfolio vs weighted average GHG Intensity of the benchmark.

Sustainability indicators measure how the environmental or social characteristics promoted by the financial product are attained.

- Confirmation that Principal adverse impacts (PAIs) of investment decisions on sustainability factors are considered through the application of exclusion criteria.
- **What are the objectives of the sustainable investments that the financial product partially intends to make and how does the sustainable investment contribute to such objectives?**

Sustainable investments contribute to environmental and/or social objectives, for which the Investment Manager uses as reference frameworks, among others, the UN Sustainable Development Goals (SDGs), as well as the objectives of the EU Taxonomy:

1. Climate Change Mitigation
2. Climate Change Adaptation
3. Sustainable Use and Protection of Water and Marine Resources
4. Transition to a Circular Economy
5. Pollution Prevention and Control
6. Protection and Restoration of Biodiversity and Ecosystems

The assessment of the positive contribution to the environmental or social objectives is based on a proprietary framework which combines quantitative elements with qualitative inputs from internal research. The methodology applies first a quantitative breakdown of a securities issuer into its business activities. The qualitative element of the framework is an assessment if business activities contribute positively to an environmental or a social objective.

To calculate the positive contribution on the Sub-Fund level the revenue share of each issuer attributable to business activities contributing to environmental and/or social objectives is considered provided the issuer is satisfying the Do No Significant Harm (“DNSH”) and Good Governance principles, and an asset-weighted aggregation is performed as a second step. Moreover, for certain types of securities, which finance specific projects contributing to environmental or social objectives the overall investment is considered to contribute to environmental and/or social objectives, but also for these a DNSH as well as a Good Governance check for issuers is performed.

- **How do the sustainable investments that the financial product partially intends to make, not cause significant harm to any environmental or social sustainable investment objective?**

In order to ensure that Sustainable Investments do not significantly harm any other environmental and/or social objective, the Investment Manager is leveraging the PAI indicators, whereby significance thresholds have been defined to identify significantly harmful issuers. Issuers not meeting the significance threshold can be engaged for a limited time period to remediate the adverse impact. Otherwise, if the issuer does not meet the defined significance thresholds twice subsequently or in case of a failed engagement, it does not pass the DNSH assessment. Investments in securities of issuers which do not pass the DNSH assessment are not counted as sustainable investments.

- *How have the indicators for adverse impacts on sustainability factors been taken into account?*

All mandatory PAI indicators are considered either as part of the application of the exclusion criteria or through thresholds on a sectorial or absolute basis. Significance thresholds have been defined and they refer to qualitative or quantitative criteria.

Recognizing the lack of data coverage for some of the PAI indicators equivalent data points are used to assess PAI indicators when applying the DNSH assessment, when relevant, for the following indicators for corporates: share of non-renewable energy consumption and production, activities negatively affecting biodiversity-sensitive areas, emissions to water, lack of processes and compliance mechanisms to monitor compliance with UNGC principles and OECD Guidelines for Multinational Enterprises; for sovereigns: GHG Intensity and investee countries subject to social violations. In case of securities which finance specific projects contributing to environmental or social objectives equivalent data at project level might be used to ensure that Sustainable Investments do not significantly harm any other environmental and/or social objective. The Investment Manager will strive to increase data coverage for PAI indicators with low data coverage by engaging with issuers and data providers. The Investment Manager will regularly evaluate whether the availability of data has increased sufficiently to potentially include assessment of such data in the investment process.

Principal adverse impacts are the most significant negative impacts of investment decisions on sustainability factors relating to environmental, social and employee matters, respect for human rights, anti-corruption and anti-bribery matters.

- *How are the sustainable investments aligned with the OECD Guidelines for Multinational Enterprises and the UN Guiding Principles on Business and Human Rights? Details:*

The Investment Manager's sustainable minimum exclusion list screens out companies based on their involvement in controversial practices against international norms. The core normative framework consists of the Principles of the UN Global Compact, the OECD Guidelines for Multinational Enterprises and the UN Guiding Principles for Business and Human Rights. Securities issued by companies having a severe violation of these frameworks will be restricted from the investment universe.

The EU Taxonomy sets out a "do not significant harm" principle by which Taxonomy-aligned investments should not significantly harm EU Taxonomy objectives and is accompanied by specific EU criteria.

The "do not significant harm" principle applies only to those investments underlying the financial product that take into account the EU criteria for environmentally sustainable economic activities. The investments underlying the remaining portion of this financial product do not take into account the EU criteria for environmentally sustainable economic activities.

Any other sustainable investments must also not significantly harm any environmental or social objectives.



Does this financial product consider principal adverse impacts on sustainability factors?

Yes

No

The Management Company has joined the Net Zero Asset Manager Initiative and considers PAI indicators through stewardship including engagement, both are relevant to mitigate potential adverse impact as a company.

Due to the commitment to the Net Zero Asset Manager Initiative, the Management Company aims to reduce greenhouse gas emissions in partnership with asset owner clients on decarbonisation goals, consistent with an ambition to reach net zero emission by 2050 or sooner across all assets under management. As part of this objective the Management Company will set an interim target for the proportion of assets to be managed in line with the attainment of net zero emissions by 2050 or sooner.

The Sub-Fund's Investment Manager addresses PAI indicators regarding greenhouse gas emission, biodiversity, water, waste as well as social and employee matters for corporate issuers, and, where relevant, the freedom house index is applied to investments in sovereigns. PAI indicators are considered within the Investment Manager's investment process through the means of exclusions as described in the "binding elements" section of the Sub-Fund.

The data coverage for the data required for the PAI indicators is heterogenous. The data coverage related to biodiversity, water and waste is low and the related PAI indicators are considered through exclusion of securities issued by companies having a severe violation / breach of principles and guidelines such as the Principles of the United Nations Global Compact, the OECD Guidelines for Multinational Enterprises, and the United Nations Guiding Principles for Business and Human Rights on the grounds of problematic practices around human rights, labour rights, environment, and corruption issues. Therefore, the Investment Manager will strive to increase data coverage for PAI indicators with low data coverage. The Investment Manager will regularly evaluate whether the availability of data has increased sufficiently to potentially include assessment of such data in the investment process.

Additionally, the Investment manager considers GHG related PAI indicators by outperforming the Weighted Average GHG Intensity against its benchmark.

The following PAI indicators are considered:

Applicable to corporate issuers

- GHG Emissions
- Carbon footprint
- GHG Intensity of investee companies
- Exposure to companies active in the fossil fuel sector
- Activities negatively affecting biodiversity-sensitive areas
- Emissions to water
- Hazardous waste ratio

- Violation of UN Global compact principles
- Lack of processes and compliance mechanisms to monitor compliance with UN Global Compact principles
- Board gender diversity
- Exposure to controversial weapons

Applicable to sovereign and supranational issuers

- Investee countries subject to social violations

The information on the PAI indicators will be available in the end-year report of the Sub-Fund.



The investment strategy guides investment decisions based on factors such as investment objectives and risk tolerance.

What investment strategy does this financial product follow?

Allianz Global Intelligent Cities Income's investment objective is to invest in global Equity and Bond Markets with a focus on companies whose business will benefit from or is currently related to evolution of intelligent cities and connected communities in accordance with the Sustainability Key Performance Indicator Strategy (Relative) ("KPI Strategy (Relative)").

The Sub-Fund's strategy is to outperform the Weighted Average GHG Intensity against its benchmark. The outperformance is determined as the excess between the Sub-Fund's weighted average GHG Intensity and the Sub-Fund's benchmark Weighted Average GHG Intensity.

The weighted average GHG Intensity is the weighted average of the Sub-Fund's GHG Intensity (in tCO₂e per Millions of sales). Sales represent company's annual sales. This ratio of GHG normalized by Sales facilitates comparison between companies of different sizes. The ratio is in tCO₂e per Millions of sales. The metric allows comparing weighted average GHG Intensities of different portfolios to identify portfolios comprised of more GHG-efficient issuers in terms of the issuer's sales. The portfolio weights (and benchmark or universe weights) are rebased such that only issuers with GHG emissions data available are considered in the calculation. GHG represents a respective issuer's greenhouse gas emissions. To determine the GHG Intensity of a company issuer, GHG Intensity data from third party data providers will be used. The GHG intensity is analysed by the Investment Manager and is considered within the securities selection process in order to meet the Sub-Fund Investment objective.

The proportion of assets which do not have a GHG intensity assessment is expected to be low. Examples of instruments not having a GHG intensity assessment are cash and deposits, some Target Funds, and investments for which the GHG intensity is deemed to be not appropriate and/or data is not available.

The Sub-Fund's general investment approach (Sub-Fund's applicable General Asset Class Principles in combination with its individual investment restrictions) is described in the prospectus.

● What are the binding elements of the investment strategy used to select the investments to attain each of the environmental or social characteristics promoted by this financial product?

The binding elements are:

- Min. 80% KPI coverage of the Sub-Fund's Portfolio (Portfolio in this respect does not comprise derivatives and instruments that are non-evaluated by nature (e. g., cash and deposits)).
- Min. 20% outperformance of benchmark in terms of Weighted Average GHG Intensity.
- Application of the following sustainable minimum exclusion criteria for direct investments:
 - securities issued by companies having a severe violation / breach of principles and guidelines such as the Principles of the United Nations Global Compact, the OECD Guidelines for Multinational Enterprises, and the United Nations Guiding Principles for Business and Human Rights on the grounds of problematic practices around human rights, labour rights, environment, and corruption issues,
 - securities issued by companies involved in controversial weapons (anti-personnel mines, cluster munitions, chemical weapons, biological weapons, depleted uranium, white phosphorus, and nuclear weapons),
 - securities issued by companies that derive more than 10% of their revenues from weapons, military equipment, and services,
 - securities issued by companies that derive more than 10% of their revenue from thermal coal extraction,
 - securities issued by utility companies that generate more than 20% of their revenues from coal,

- securities issued by companies involved in the production of tobacco, and securities issued by companies involved in the distribution of tobacco with more than 5% of their revenues.

Direct investments in sovereign issuers with an insufficient freedom house index score are excluded.

The sustainable minimum exclusion criteria are based on information from an external data provider and coded in pre- and post-trade compliance. The review is performed at least half yearly.

- **What is the committed minimum rate to reduce the scope of the investments considered prior to the application of that investment strategy?**

The Sub-Fund does not commit to reduce the scope of the investments by a certain minimum rate.

- **What is the policy to assess good governance practices of the investee companies?**

Good governance principles are considered by screening out companies based on their involvement in controversies around international norms corresponding to the four good governance practices: sound management structures, employee relations, remuneration of staff and tax compliance. Companies having a severe violation in either of those areas will not be investible. For certain cases, flagged issuers shall be on a watch list. These companies will appear on this watch list when the Investment Manager believes that engagement may lead to improvements or when the company is assessed to take remedial actions. Companies on the watch list remain investible unless the Investment Manager believes that the engagement or the remedial actions of the company does not lead to the desired remedy of the severe controversy.

In addition, the Sub-Fund's Investment Manager is committed to actively encourage open dialogues with investee companies on corporate governance, proxy voting and broader sustainability issues in advance of shareholder meetings (regularly for direct investments in shares). The Sub-Fund's Investment Manager's approach to proxy voting and company engagement is set out in the Management Company's Stewardship Statement.

Good governance practices include sound management structures, employee relations, remuneration of staff and tax compliance.



What is the asset allocation planned for this financial product?

Asset allocation describes the share of investments in specific assets.

Min. 80% of the Sub-Funds' assets (excluding cash, and derivatives) are used to meet the environmental or social characteristics promoted by this Sub-Fund. A low portion of the Sub-Fund might contain assets which do not promote environmental or social characteristics. Examples of such instruments are derivatives, cash and deposits, some Target Funds and investment with temporarily divergent or absent environmental, social, or good governance qualifications. Min. 10% of the Sub-Funds' assets will be invested in Sustainable Investments. The minimum percentage of investments that are aligned with the EU Taxonomy is 0.01%. The Sub-Fund's Investment Manager does not commit to a minimum share of environmentally Sustainable Investments that are not aligned with the EU Taxonomy. The Sub-Fund's Investment Manager does not commit to a minimum share of socially sustainable investments. While the Sub-Fund cannot commit to a minimum share of environmentally or socially sustainable investments, such investments may be freely allocated to within the Sub-Fund aggregated sustainable investment commitment disclosed (min. 10%).

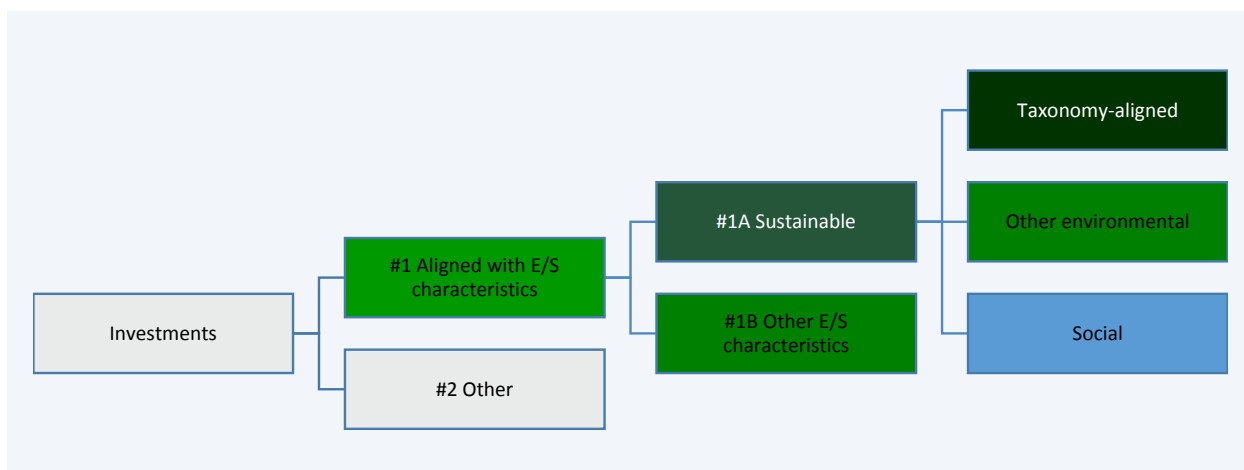

#1 Aligned with E/S characteristics includes the investments of the financial product used to attain the environmental or social characteristics promoted by the financial product.

#2 Other includes the remaining investments of the financial product which are neither aligned with the environmental or social characteristics, nor are qualified as sustainable investments.

The category **#1 Aligned with E/S characteristics** covers:

- The sub-category **#1A Sustainable** covers sustainable investments with environmental or social objectives.
- The sub-category **#1B Other E/S characteristics** covers investments aligned with the environmental or social characteristics that do not qualify as sustainable investments.

- **How does the use of derivatives attain the environmental or social characteristics promoted by the financial product?**

Not applicable



To what minimum extent are sustainable investments with an environmental objective aligned with the EU Taxonomy?

The Taxonomy-aligned investments include debt and/or equity in environmentally sustainable economic activities aligned with the EU-Taxonomy. The minimum percentage of investments that are aligned with the EU Taxonomy is 0.01%. Taxonomy-aligned data is provided by an external data provider. The Investment Manager has assessed the quality of such data. The data will not be subject to an assurance provided by auditors or a review by third parties. The data will not reflect any data in government bonds. As of today, there is no recognized methodology available to determine the proportion of Taxonomy-aligned activities when investing in government bonds.

Taxonomy-aligned activities in this disclosure are based on share of turnover. Pre-contractual figures use turnover as its financial metric as a default in line with the regulatory requirements and based on the fact that complete, verifiable or up-to date data for CAPEX and/or OPEX as financial metric is even less available.

Taxonomy-aligned data is only in rare cases data reported by companies in accordance with the EU Taxonomy. The data provider has derived Taxonomy-aligned data from other available equivalent public data.

- **Does the financial product invest in fossil gas and/or nuclear energy related activities that comply with the EU Taxonomy¹?**

Yes:

In fossil gas In nuclear energy

No

The Sub-Fund does not pursue any investments in fossil gas and/or nuclear energy related activities that comply with the EU Taxonomy. Nevertheless, as result of this investment strategy, investments may occur in corporates which are also active in these activities. Further information will be provided as part of the annual reporting, if relevant.

Taxonomy-aligned activities are expressed as a share of:

- **turnover** reflecting the share of revenue from green activities of investee companies
- **capital expenditure** (CapEx) showing the green investments made by investee companies, e.g. for a transition to a green economy.
- **operational expenditure** (OpEx) reflecting green operational activities of investee companies.

¹ Fossil gas and/or nuclear related activities will only comply with the EU Taxonomy where they contribute to limiting climate change ("climate change mitigation") and do not significantly harm any EU Taxonomy objective - see explanatory note in the left hand margin. The full criteria for fossil gas and nuclear energy economic activities that comply with the EU Taxonomy are laid down in Commission Delegated Regulation (EU) 2022/1214.

The two graphs below show in green the minimum percentage of investments that are aligned with the EU Taxonomy. As there is no appropriate methodology to determine the Taxonomy-alignment of sovereign bonds*, the first graph shows the Taxonomy-alignment in relation to all the investments of the financial product including sovereign bonds, while the second graph shows the Taxonomy-alignment only in relation to the investments of the financial product other than sovereign bonds.

1. Taxonomy-alignment of investments including sovereign bonds*

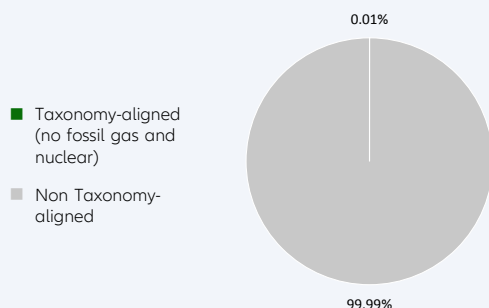

2. Taxonomy-alignment of investments excluding sovereign bonds*

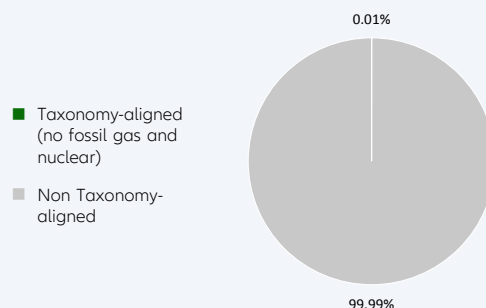

This graph represents X% of the total investments. It is noted that this Sub-Fund does not provide for a binding minimum quota for investments in sovereign bonds. Therefore, this Sub-Fund may have (but must not have) an exposure to sovereign bonds. In the absence of a binding minimum quota for investments in sovereign bonds, this graph does not generate any additional added value compared to the left-hand graph.

* For the purpose of these graphs, 'sovereign bonds' consist of all sovereign exposures

Enabling activities directly enable other activities to make a substantial contribution to an environmental objective.

Transitional activities are activities for which low-carbon alternatives are not yet available and among others have greenhouse gas emission levels corresponding to the best performance.

● **What is the minimum share of investments in transitional and enabling activities?**

The Sub-Fund's Investment Manager does not commit to a split of minimum taxonomy alignment into transitional, enabling activities and own performance.



What is the minimum share of sustainable investments with an environmental objective that are not aligned with the EU Taxonomy?

Taxonomy-aligned investments are considered a sub-category of Sustainable Investments. If an investment is not Taxonomy-aligned since the activity is not yet covered under the EU Taxonomy or the positive contribution is not substantial enough to comply with the Taxonomy technical screening criteria, the investment can still be considered an environmentally Sustainable Investment provided it complies with all criteria. The Investment Manager does not commit to a minimum share of environmentally Sustainable Investments that are not aligned with the EU Taxonomy. The overall sustainable investment share may also include investments with an environmental objective in economic activities that do not qualify as environmentally sustainable under the EU Taxonomy, and while the Sub-Fund cannot commit to a minimum share of environmentally or socially sustainable investments, such investments may be freely allocated to within the Sub-Fund aggregated sustainable investment commitment disclosed (min. 10%).



are sustainable investments with an environmental objective that **do not take into account the criteria** for environmentally sustainable economic activities under the EU Taxonomy.



What is the minimum share of socially sustainable investments?

The Investment Manager defines Sustainable Investments based on internal research, which uses, among others, the UN Sustainable Development Goals (SDGs), as well as the objectives of the EU Taxonomy as reference frameworks. The Investment Manager does not commit to a minimum share of socially Sustainable Investments, as the SDGs contain environmental as well as social objectives. The overall sustainable investment share may also include investments with a social objective, and while the Sub-Fund cannot commit to a minimum share of environmentally or socially sustainable investments, such investments may be freely allocated to within the Sub-Fund aggregated sustainable investment commitment disclosed (min 10%).



What investments are included under “#2 Other”, what is their purpose and are there any minimum environmental or social safeguards?

Under “#2 Other” investments into cash, Target Funds, or derivatives can be included. Derivatives might be used for efficient portfolio management (including risk hedging) and/or investment purposes, and Target Funds to benefit from a specific strategy. For those investments no environmental or social safeguards are applied.



Is a specific index designated as a reference benchmark to determine whether this financial product is aligned with the environmental and/or social characteristics that it promotes?

Yes, the Sub-Fund has assigned a composite benchmark 70% MSCI AC World (ACWI) Total Return Net + 30% ICE BOFAML US Corporate & High Yield Index. This composite benchmark is using market indices. The Sub-Fund will promote environmental and social characteristics by outperforming the benchmark's Weighted Average GHG Intensity

- **How is the reference benchmark continuously aligned with each of the environmental or social characteristics promoted by the financial product?**

The composite benchmark uses market indices and does not incorporate environmental or social characteristics for index construction.

- **How is the alignment of the investment strategy with the methodology of the index ensured on a continuous basis?**

The benchmark is not continuously aligned as it does not incorporate environmental or social characteristics for index construction.

- **How does the designated index differ from a relevant broad market index?**

The composite benchmark uses broad market indices.

- **Where can the methodology used for the calculation of the designated index be found?**

Details of the Benchmark's methodology may be found at <https://www.msci.com/documents/10199/a71b65b5-d0ea-4b5c-a709-24b1213bc3c5> or at www.msci.com and at <https://www.theice.com/market-data/indices/fixed-income-indices>

Reference benchmarks are indexes to measure whether the financial product attains the environmental or social characteristics that they promote.



Where can I find more product specific information online?

More product-specific information can be found on the website: <https://regulatory.allianzgi.com/SFDR>

Template pre-contractual disclosure for the financial products referred to in Article 8, paragraphs 1, 2 and 2a, of Regulation (EU) 2019/2088 and Article 6, first paragraph, of Regulation (EU) 2020/852

Product name:

Allianz Global Multi Asset Sustainability Balanced

Legal entity identifier: 549300IVJKX5A2N0KP64

Environmental and/or social characteristics

Sustainable investment means an investment in an economic activity that contributes to an environmental or social objective, provided that the investment does not significantly harm any environmental or social objective and that the investee companies follow good governance practices.

The EU Taxonomy is a classification system laid down in Regulation (EU) 2020/852, establishing a list of environmentally sustainable economic activities. That Regulation does not include a list of socially sustainable economic activities. Sustainable investments with an environmental objective might be aligned with the Taxonomy or not.

Does this financial product have a sustainable investment objective?	
Yes	No
<input type="checkbox"/> It will make a minimum of sustainable investments with an environmental objective: ___% <input type="checkbox"/> in economic activities that qualify as environmentally sustainable under the EU Taxonomy <input type="checkbox"/> in economic activities that do not qualify as environmentally sustainable under the EU Taxonomy	<input checked="" type="checkbox"/> It promotes Environmental/Social (E/S) characteristics and while it does not have as its objective a sustainable investment, it will have a minimum proportion of 3.00% of sustainable investments <input checked="" type="checkbox"/> with an environmental objective in economic activities that qualify as environmentally sustainable under the EU Taxonomy <input checked="" type="checkbox"/> with an environmental objective in economic activities that do not qualify as environmentally sustainable under the EU Taxonomy <input checked="" type="checkbox"/> with a social objective
<input type="checkbox"/> It will make a minimum of sustainable investments with a social objective ___%	<input type="checkbox"/> It promotes E/S characteristics, but will not make any sustainable investments



What environmental and/or social characteristics are promoted by this financial product?

Allianz Global Multi Asset Sustainability Balanced (the "Sub-Fund") promotes a broad range of environmental and/or social characteristics. The Sub-Fund invests at least 70% of its assets following the "Multi Asset Sustainability Strategy" which includes, but is not limited to, various sustainability strategies of the management company and/or, invests in Green Bonds and/or SFDR Article 8 & 9 Target Funds ("SFDR Target Funds").

Depending on the sustainability strategy selected by the Investment Manager the promoted environmental and/or social characteristics could comprise environmental, social, human rights, governance, business behaviour factors or investments in companies providing solutions that create positive environmental and social outcomes.

In addition, sustainable minimum exclusion criteria apply.

No reference benchmark has been designated for the purpose of attaining the environmental and/or social characteristics promoted by the Sub-Fund.

- **What sustainability indicators are used to measure the attainment of each of the environmental or social characteristics promoted by this financial product?**

As part of the Multi Asset Sustainability Strategy the Investment Manager allocates at least 70% of Fund's assets in various sustainability approaches.

Sustainability indicators measure how the environmental or social characteristics promoted by the financial product are attained.

To measure the attainment of the environmental and/or social characteristics the following sustainability indicators are used and reported on, at the fiscal year end:

- The actual percentage of the Sub-Fund's assets invested in Green Bonds and/or in SFDR Target Funds and/or in Equities and/or Debt Securities in accordance with the Multi Asset Sustainability Strategy.
- In case the Investment Manager decides to directly invest in Debt or Equity Securities as part of the Multi Asset Sustainability Strategy the adherence to the respective binding element will be reported.
- Confirmation that Principal Adverse Impacts (PAIs) of investment decisions on sustainability factors are considered through the application of exclusion criteria (with exception of cash, derivatives, external Target Funds and internal Target Funds not following a sustainability strategy).

● **What are the objectives of the sustainable investments that the financial product partially intends to make and how does the sustainable investment contribute to such objectives?**

Sustainable investments contribute to environmental and/or social objectives, for which the Investment Manager uses as reference frameworks, among others, the UN Sustainable Development Goals (SDGs), as well as the objectives of the EU Taxonomy:

1. Climate Change Mitigation
2. Climate Change Adaptation
3. Sustainable Use and Protection of Water and Marine Resources
4. Transition to a Circular Economy
5. Pollution Prevention and Control
6. Protection and Restoration of Biodiversity and Ecosystems

The assessment of the positive contribution to the environmental or social objectives is based on a proprietary framework which combines quantitative elements with qualitative inputs from internal research. The methodology applies first a quantitative breakdown of a securities issuer into its business activities. The qualitative element of the framework is an assessment if business activities contribute positively to an environmental or a social objective.

To calculate the positive contribution on the Sub-Fund level the revenue share of each issuer attributable to business activities contributing to environmental and/or social objectives is considered provided the issuer is satisfying the Do No Significant Harm ("DNSH") and Good Governance principles, and an asset-weighted aggregation is performed as a second step. Moreover, for certain types of securities, which finance specific projects contributing to environmental or social objectives the overall investment is considered to contribute to environmental and/or social objectives, but also for these a DNSH as well as a Good Governance check for issuers is performed.

● **How do the sustainable investments that the financial product partially intends to make, not cause significant harm to any environmental or social sustainable investment objective?**

In order to ensure that Sustainable Investments do not significantly harm any other environmental and/or social objective, the Investment Manager is leveraging the PAI indicators, whereby significance thresholds have been defined to identify significantly harmful issuers. Issuers not meeting the significance threshold can be engaged for a limited time period to remediate the adverse impact. Otherwise, if the issuer does not meet the defined significance thresholds twice subsequently or in case of a failed engagement, it does not pass the DNSH assessment. Investments in securities of issuers which do not pass the DNSH assessment are not counted as sustainable investments.

● *How have the indicators for adverse impacts on sustainability factors been taken into account?*

All mandatory PAI indicators are considered either as part of the application of the exclusion criteria or through thresholds on a sectorial or absolute basis. Significance thresholds have been defined and they refer to qualitative or quantitative criteria.

Recognizing the lack of data coverage for some of the PAI indicators equivalent data points are used to assess PAI indicators when applying the DNSH assessment, when relevant, for the following indicators for corporates: share of non-renewable energy consumption and production, activities negatively affecting biodiversity-sensitive areas, emissions to water, lack of processes and compliance mechanisms to monitor compliance with UNGC principles and OECD Guidelines for Multinational Enterprises; for sovereigns: GHG Intensity and investee countries subject to social violations. In case of securities which finance specific projects contributing to environmental or social objectives equivalent data at project

Principal adverse impacts are the most significant negative impacts of investment decisions on sustainability factors relating to environmental, social and employee matters, respect for human rights, anti-corruption and anti-bribery matters.

level might be used to ensure that Sustainable Investments do not significantly harm any other environmental and/or social objective. The Investment Manager will strive to increase data coverage for PAI indicators with low data coverage by engaging with issuers and data providers. The Investment Manager will regularly evaluate whether the availability of data has increased sufficiently to potentially include assessment of such data in the investment process.

● *How are the sustainable investments aligned with the OECD Guidelines for Multinational Enterprises and the UN Guiding Principles on Business and Human Rights? Details:*

The Investment Manager's sustainable minimum exclusion list screens out companies based on their involvement in controversial practices against international norms. The core normative framework consists of the Principles of the UN Global Compact, the OECD Guidelines for Multinational Enterprises and the UN Guiding Principles for Business and Human Rights. Securities issued by companies having a severe violation of these frameworks will be restricted from the investment universe.

The EU Taxonomy sets out a "do not significant harm" principle by which Taxonomy-aligned investments should not significantly harm EU Taxonomy objectives and is accompanied by specific EU criteria.

The "do not significant harm" principle applies only to those investments underlying the financial product that take into account the EU criteria for environmentally sustainable economic activities. The investments underlying the remaining portion of this financial product do not take into account the EU criteria for environmentally sustainable economic activities.

Any other sustainable investments must also not significantly harm any environmental or social objectives.



Does this financial product consider principal adverse impacts on sustainability factors?

Yes

No

The Management Company has joined the Net Zero Asset Manager Initiative and considers PAI indicators through stewardship including engagement, both are relevant to mitigate potential adverse impact as a company.

Due to the commitment to the Net Zero Asset Manager Initiative, the Management Company aims to reduce greenhouse gas emissions in partnership with asset owner clients on decarbonisation goals, consistent with an ambition to reach net zero emission by 2050 or sooner across all assets under management. As part of this objective the Management Company will set an interim target for the proportion of assets to be managed in line with the attainment of net zero emissions by 2050 or sooner.

The Sub-Fund's Investment Manager addresses PAI indicators regarding greenhouse gas emission, biodiversity, water, waste as well as social and employee matters for corporate issuers, and, where relevant, the freedom house index is applied to investments in sovereigns. PAI indicators are considered within the Investment Manager's investment process through the means of exclusions as described in the "binding elements" section of the Sub-Fund.

The data coverage for the data required for the PAI indicators is heterogenous. The data coverage related to biodiversity, water and waste is low and the related PAI indicators are considered through exclusion of securities issued by companies having a severe violation / breach of principles and guidelines such as the Principles of the United Nations Global Compact, the OECD Guidelines for Multinational Enterprises, and the United Nations Guiding Principles for Business and Human Rights on the grounds of problematic practices around human rights, labour rights, environment, and corruption issues. Therefore, the Investment Manager will strive to increase data coverage for PAI indicators with low data coverage. The Investment Manager will regularly evaluate whether the availability of data has increased sufficiently to potentially include assessment of such data in the investment process.

The following PAI indicators are considered:

Applicable to corporate issuers

- GHG Emissions
- Carbon footprint
- GHG Intensity of investee companies
- Exposure to companies active in the fossil fuel sector
- Activities negatively affecting biodiversity-sensitive areas

- Emissions to water
- Hazardous waste ratio
- Violation of UN Global compact principles
- Lack of processes and compliance mechanisms to monitor compliance with UN Global Compact principles
- Board gender diversity
- Exposure to controversial weapons

Applicable to sovereign and supranational issuers

- Investee countries subject to social violations

The information on the PAI indicators will be available in the end-year report of the Sub-Fund.



The investment strategy guides investment decisions based on factors such as investment objectives and risk tolerance.

What investment strategy does this financial product follow?

Allianz Global Multi Asset Sustainability Balanced's investment objective is to invest in a broad range of asset classes, with a focus on global equity, bond and money markets in order to achieve over the medium-term a performance comparable to a balanced portfolio consisting of 50% global equity markets and 50% global bond markets in accordance with the Multi Asset Sustainability Strategy. A Sub-Fund managed according to the Multi Asset Sustainability Strategy ("MAS Strategy") invests in (i) Equities and / or Debt Securities of companies that either provide for environmental and/or social characteristics and/or pursue activities contributing to an environmental or social objective and / or invests (ii) in Green Bonds and/or (iii) in SFDR Target Funds.

In case of direct investments in Equities and/or Debt Securities, the Sub-Fund's Investment Manager may choose one or more of the below strategies that promote environmental and/or social characteristics and/or pursue activities contributing to an environmental or social objective:

- SRI Strategy

The Sub-Fund or strategy promotes environmental and social characteristics through integrating environmental, social, human rights, governance and business behaviour factors into the Sub-Fund's investment process through a best-in-class approach. This encompasses the evaluation of corporate or sovereign issuers based on an SRI Rating that it is used to construct the portfolio.

- SDG-Aligned

The Sub-Fund's or strategy's Sustainable Investment objective is to invest in Equities and/or in Debt Securities of companies providing solutions that create positive environmental and social outcomes, as assessed by the contribution of companies' outputs to the attainment of one or more of the SDGs or other Sustainable Investment objectives, which the Sub-Fund's Investment Manager may additionally determine and to which the companies contribute to.

- Green Bond Strategy

The Sub-Fund's or strategy's Sustainable Investment objective is to mobilize capital markets towards the transition to a low carbon society, natural capital preservation and adaptation to climate change. The Sub-Fund or strategy invests primarily in Green Bonds financing climate change mitigation or adaptation projects or other environmental sustainability projects, notably in the following fields: energy efficiency, renewable energy, raw materials, water and land, waste management, greenhouse gas emissions reduction, biodiversity preservation or circular economy.

The Sub-Fund's general investment approach (Sub-Fund's applicable General Asset Class Principles in combination with its individual investment restrictions) is described in the prospectus.

● What are the binding elements of the investment strategy used to select the investments to attain each of the environmental or social characteristics promoted by this financial product?

A Sub-Fund managed according to the Multi Asset Sustainability Strategy ("MAS Strategy") invests in (i) Equities and / or Debt Securities of companies that either provide for environmental and/or social characteristics and/or pursue activities contributing to an environmental or social objective and / or invests (ii) in Green Bonds and/or (iii) in SFDR Target Funds.

Overall, the Investment Manager is required to invest min 70% of Sub-Fund's assets in SFDR Target Funds and/or in Equities and/or Debt Securities in accordance with the Multi Asset Sustainability Strategy.

- Application of the following sustainable minimum exclusion criteria for direct investments (with exception of cash, derivatives, external Target Funds, and internal Target Funds not following a sustainable strategy):
- securities issued by companies having a severe violation / breach of principles and guidelines such as the Principles of the United Nations Global Compact, the OECD Guidelines for Multinational Enterprises, and the United Nations Guiding Principles for Business and Human Rights on the grounds of problematic practices around human rights, labour rights, environment, and corruption issues,
- securities issued by companies involved in controversial weapons (anti-personnel mines, cluster munitions, chemical weapons, biological weapons, depleted uranium, white phosphorus, and nuclear weapons),
- securities issued by companies that derive more than 10% of their revenues from weapons, military equipment, and services,
- securities issued by companies that derive more than 10% of their revenue from thermal coal extraction,
- securities issued by utility companies that generate more than 20% of their revenues from coal,
- securities issued by companies involved in the production of tobacco, and securities issued by companies involved in the distribution of tobacco with more than 5% of their revenues.

Direct investments in sovereign issuers with an insufficient freedom house index score are excluded.

The sustainable minimum exclusion criteria are based on information from an external data provider and coded in pre- and post-trade compliance. The review is performed at least half yearly.

● **What is the committed minimum rate to reduce the scope of the investments considered prior to the application of that investment strategy?**

The Sub-Fund does not commit to reduce the scope of the investments by a certain minimum rate.

● **What is the policy to assess good governance practices of the investee companies?**

Good governance principles are considered by screening out companies based on their involvement in controversies around international norms corresponding to the four good governance practices: sound management structures, employee relations, remuneration of staff and tax compliance. Companies having a severe violation in either of those areas will not be investible. For certain cases, flagged issuers shall be on a watch list. These companies will appear on this watch list when the Investment Manager believes that engagement may lead to improvements or when the company is assessed to take remedial actions. Companies on the watch list remain investible unless the Investment Manager believes that the engagement or the remedial actions of the company does not lead to the desired remedy of the severe controversy.

In addition, the Sub-Fund's Investment Manager is committed to actively encourage open dialogues with investee companies on corporate governance, proxy voting and broader sustainability issues in advance of shareholder meetings (regularly for direct investments in shares). The Sub-Fund's Investment Manager's approach to proxy voting and company engagement is set out in the Management Company's Stewardship Statement.

Good governance practices include sound management structures, employee relations, remuneration of staff and tax compliance.



What is the asset allocation planned for this financial product?

Asset allocation describes the share of investments in specific assets.

Min. 70% of the Sub-Funds' assets are used to meet the environmental or social characteristics promoted by this Sub-Fund. A low portion of the Sub-Fund might contain assets which do not promote environmental or social characteristics. Example of such instruments are derivatives, cash and deposits, some Target Funds and investment with temporarily divergent or absent environmental, social, or good governance qualifications or investments outside of the specified quota to be invested as part of the Multi Asset Sustainability Strategy. Min. 3% of the Sub-Funds' assets will be invested in Sustainable Investments. The minimum percentage of investments that are aligned with the EU Taxonomy is 0.01%. The Sub-Fund's Investment Manager does not commit to a minimum share of environmentally Sustainable Investments that are not aligned with the EU Taxonomy. The Sub-Fund's Investment Manager does not commit to a minimum share of socially sustainable investments. While the Sub-Fund cannot commit to a minimum share of environmentally or socially sustainable investments, such investments may be freely allocated to within the Sub-Fund aggregated sustainable investment commitment disclosed (min. 3%).

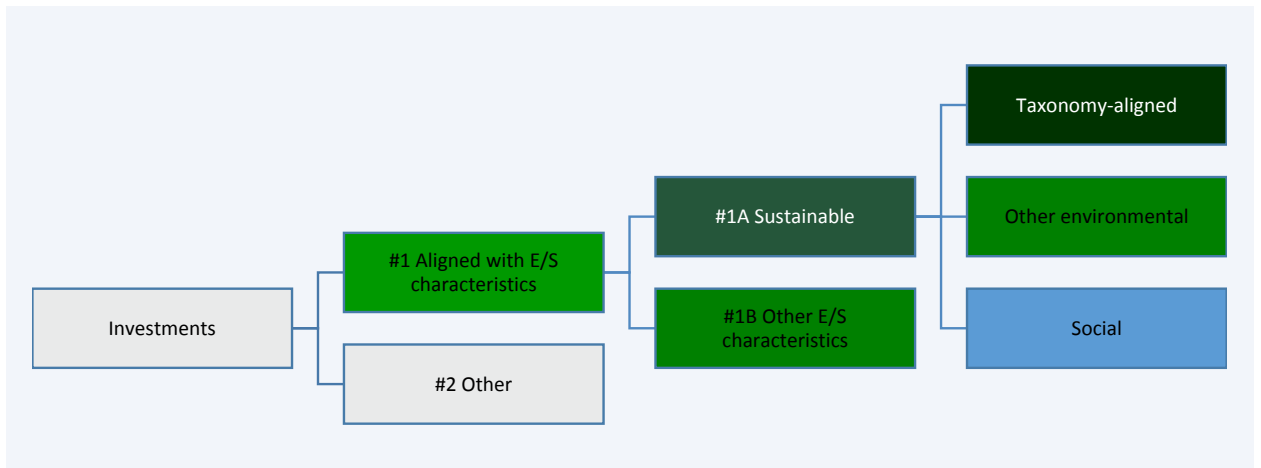

#1 Aligned with E/S characteristics includes the investments of the financial product used to attain the environmental or social characteristics promoted by the financial product.

#2 Other includes the remaining investments of the financial product which are neither aligned with the environmental or social characteristics, nor are qualified as sustainable investments.

The category **#1 Aligned with E/S characteristics** covers:

- The sub-category **#1A Sustainable** covers sustainable investments with environmental or social objectives.
- The sub-category **#1B Other E/S characteristics** covers investments aligned with the environmental or social characteristics that do not qualify as sustainable investments.

● **How does the use of derivatives attain the environmental or social characteristics promoted by the financial product?**

Not applicable



To what minimum extent are sustainable investments with an environmental objective aligned with the EU Taxonomy?

The Taxonomy-aligned investments include debt and/or equity in environmentally sustainable economic activities aligned with the EU-Taxonomy. The minimum percentage of investments that are aligned with the EU Taxonomy is 0.01%. Taxonomy-aligned data is provided by an external data provider. The Investment Manager has assessed the quality of such data. The data will not be subject to an assurance provided by auditors or a review by third parties. The data will not reflect any data in government bonds. As of today, there is no recognized methodology available to determine the proportion of Taxonomy-aligned activities when investing in government bonds.

Taxonomy-aligned activities in this disclosure are based on share of turnover. Pre-contractual figures use turnover as its financial metric as a default in line with the regulatory requirements and based on the fact that complete, verifiable or up-to date data for CAPEX and/or OPEX as financial metric is even less available.

Taxonomy-aligned data is only in rare cases data reported by companies in accordance with the EU Taxonomy. The data provider has derived Taxonomy-aligned data from other available equivalent public data.

● **Does the financial product invest in fossil gas and/or nuclear energy related activities that comply with the EU Taxonomy ¹?**

- Yes:
 - In fossil gas
 - In nuclear energy
- No

The Sub-Fund does not pursue any investments in fossil gas and/or nuclear energy related activities that comply with the EU Taxonomy. Nevertheless, as result of this investment strategy, investments may occur in corporates which are also active in these activities. Further information will be provided as part of the annual reporting, if relevant.

Taxonomy-aligned activities are expressed as a share of:
 - **turnover** reflecting the share of revenue from green activities of investee companies
 - **capital expenditure (CapEx)** showing the green investments made by investee companies, e.g. for a transition to a green

¹ Fossil gas and/or nuclear related activities will only comply with the EU Taxonomy where they contribute to limiting climate change ("climate change mitigation") and do not significantly harm any EU Taxonomy objective - see explanatory note in the left hand margin. The full criteria for fossil gas and nuclear energy economic activities that comply with the EU Taxonomy are laid down in Commission Delegated Regulation (EU) 2022/1214.

economy.
 - **operational expenditure (OpEx)** reflecting green operational activities of investee companies.

The two graphs below show in green the minimum percentage of investments that are aligned with the EU Taxonomy. As there is no appropriate methodology to determine the Taxonomy-alignment of sovereign bonds*, the first graph shows the Taxonomy-alignment in relation to all the investments of the financial product including sovereign bonds, while the second graph shows the Taxonomy-alignment only in relation to the investments of the financial product other than sovereign bonds.

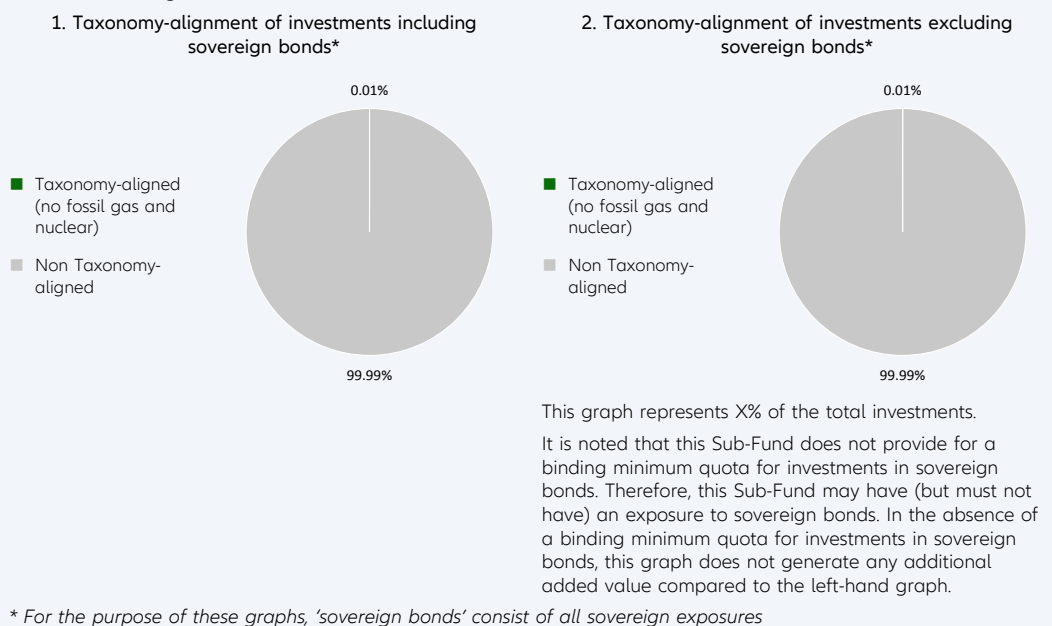

Enabling activities directly enable other activities to make a substantial contribution to an environmental objective.

● **What is the minimum share of investments in transitional and enabling activities?**

The Sub-Fund's Investment Manager does not commit to a split of minimum taxonomy alignment into transitional, enabling activities and own performance.

Transitional activities are activities for which low-carbon alternatives are not yet available and among others have greenhouse gas emission levels corresponding to the best performance.



What is the minimum share of sustainable investments with an environmental objective that are not aligned with the EU Taxonomy?

Taxonomy-aligned investments are considered a sub-category of Sustainable Investments. If an investment is not Taxonomy-aligned since the activity is not yet covered under the EU Taxonomy or the positive contribution is not substantial enough to comply with the Taxonomy technical screening criteria, the investment can still be considered an environmentally Sustainable Investment provided it complies with all criteria. The Investment Manager does not commit to a minimum share of environmentally Sustainable Investments that are not aligned with the EU Taxonomy. The overall sustainable investment share may also include investments with an environmental objective in economic activities that do not qualify as environmentally sustainable under the EU Taxonomy, and while the Sub-Fund cannot commit to a minimum share of environmentally or socially sustainable investments, such investments may be freely allocated to within the Sub-Fund aggregated sustainable investment commitment disclosed (min. 3%).

are sustainable investments with an environmental objective that **do not take into account the criteria** for environmentally sustainable economic activities under the EU Taxonomy.



What is the minimum share of socially sustainable investments?

The Investment Manager defines Sustainable Investments based on internal research, which uses, among others, the UN Sustainable Development Goals (SDGs), as well as the objectives of the EU Taxonomy as reference frameworks. The Investment Manager does not commit to a minimum share of socially Sustainable Investments, as the SDGs contain environmental as well as social objectives. The overall sustainable investment share may also include investments with a social objective, and while the Sub-Fund cannot commit to a minimum share of environmentally or socially sustainable investments, such investments may be freely allocated to within the Sub-Fund aggregated sustainable investment commitment disclosed (min. 3%).



What investments are included under “#2 Other”, what is their purpose and are there any minimum environmental or social safeguards?

Under “#2 Other” investments into cash, Target Funds, or derivatives can be included. Derivatives might be used for efficient portfolio management (including risk hedging) and/or investment purposes, and Target Funds to benefit from a specific strategy. For those investments no environmental or social safeguards are applied.



Is a specific index designated as a reference benchmark to determine whether this financial product is aligned with the environmental and/or social characteristics that it promotes?

No reference benchmark has been designated for the purpose of attaining the environmental and/or social characteristics promoted by the Sub-Fund.

- How is the reference benchmark continuously aligned with each of the environmental or social characteristics promoted by the financial product?

Not applicable

- How is the alignment of the investment strategy with the methodology of the index ensured on a continuous basis?

Not applicable

- How does the designated index differ from a relevant broad market index?

Not applicable

- Where can the methodology used for the calculation of the designated index be found?

Not applicable



Where can I find more product specific information online?

More product-specific information can be found on the website: <https://regulatory.allianzgi.com/SFDR>

Reference benchmarks are indexes to measure whether the financial product attains the environmental or social characteristics that they promote.

Template pre-contractual disclosure for the financial products referred to in Article 8, paragraphs 1, 2 and 2a, of Regulation (EU) 2019/2088 and Article 6, first paragraph, of Regulation (EU) 2020/852

Product name:

Allianz Global Multi Asset Sustainability Conservative

Legal entity identifier: 549300P41LEQN4RDYC38

Environmental and/or social characteristics

Sustainable investment means an investment in an economic activity that contributes to an environmental or social objective, provided that the investment does not significantly harm any environmental or social objective and that the investee companies follow good governance practices.

The **EU Taxonomy** is a classification system laid down in Regulation (EU) 2020/852, establishing a list of **environmentally sustainable economic activities**. That Regulation does not include a list of socially sustainable economic activities. Sustainable investments with an environmental objective might be aligned with the Taxonomy or not.

Does this financial product have a sustainable investment objective?	
Yes	No
<input type="checkbox"/> It will make a minimum of sustainable investments with an environmental objective: ___% <ul style="list-style-type: none"> <input type="checkbox"/> in economic activities that qualify as environmentally sustainable under the EU Taxonomy <input type="checkbox"/> in economic activities that do not qualify as environmentally sustainable under the EU Taxonomy 	<input checked="" type="checkbox"/> It promotes Environmental/Social (E/S) characteristics and while it does not have as its objective a sustainable investment, it will have a minimum proportion of 1.50% of sustainable investments <ul style="list-style-type: none"> <input checked="" type="checkbox"/> with an environmental objective in economic activities that qualify as environmentally sustainable under the EU Taxonomy <input checked="" type="checkbox"/> with an environmental objective in economic activities that do not qualify as environmentally sustainable under the EU Taxonomy <input checked="" type="checkbox"/> with a social objective
<input type="checkbox"/> It will make a minimum of sustainable investments with a social objective ___%	<input type="checkbox"/> It promotes E/S characteristics, but will not make any sustainable investments



What environmental and/or social characteristics are promoted by this financial product?

Allianz Global Multi Asset Sustainability Conservative (the "Sub-Fund") promotes a broad range of environmental and/or social characteristics. The Sub-Fund invests at least 70% of its assets following the "Multi Asset Sustainability Strategy" which includes, but is not limited to, various sustainability strategies of the management company and/or, invests in Green Bonds and/or Social Bonds, and/or Sustainability Bonds and/or SFDR Article 8 & 9 Target Funds ("SFDR Target Funds").

Depending on the sustainability strategy selected by the Investment Manager the promoted environmental and/or social characteristics could comprise environmental, social, human rights, governance, business behaviour factors or investments in companies providing solutions that create positive environmental and social outcomes.

In addition, sustainable minimum exclusion criteria apply.

No reference benchmark has been designated for the purpose of attaining the environmental and/or social characteristics promoted by the Sub-Fund.

- **What sustainability indicators are used to measure the attainment of each of the environmental or social characteristics promoted by this financial product?**

As part of the Multi Asset Sustainability Strategy the Investment Manager allocates at least 70% of Fund's assets in various sustainability approaches.

Sustainability indicators measure how the environmental or social characteristics promoted by the financial product are attained.

To measure the attainment of the environmental and/or social characteristics the following sustainability indicators are used and reported on, at the fiscal year end:

- The actual percentage of the Sub-Fund's assets invested in Green Bonds, and/or Social Bonds, and/or Sustainability Bonds and/or in SFDR Target Funds and/or in Equities and/or Debt Securities in accordance with the Multi Asset Sustainability Strategy.
- In case the Investment Manager decides to directly invest in Debt or Equity Securities as part of the Multi Asset Sustainability Strategy the adherence to the respective binding element will be reported.
- Confirmation that Principal Adverse Impacts (PAIs) of investment decisions on sustainability factors are considered through the application of exclusion criteria (with exception of cash, derivatives, external Target Funds and internal Target Funds not following a sustainability strategy).

● **What are the objectives of the sustainable investments that the financial product partially intends to make and how does the sustainable investment contribute to such objectives?**

Sustainable investments contribute to environmental and/or social objectives, for which the Investment Manager uses as reference frameworks, among others, the UN Sustainable Development Goals (SDGs), as well as the objectives of the EU Taxonomy:

1. Climate Change Mitigation
2. Climate Change Adaptation
3. Sustainable Use and Protection of Water and Marine Resources
4. Transition to a Circular Economy
5. Pollution Prevention and Control
6. Protection and Restoration of Biodiversity and Ecosystems

The assessment of the positive contribution to the environmental or social objectives is based on a proprietary framework which combines quantitative elements with qualitative inputs from internal research. The methodology applies first a quantitative breakdown of a securities issuer into its business activities. The qualitative element of the framework is an assessment if business activities contribute positively to an environmental or a social objective.

To calculate the positive contribution on the Sub-Fund level the revenue share of each issuer attributable to business activities contributing to environmental and/or social objectives is considered provided the issuer is satisfying the Do No Significant Harm ("DNSH") and Good Governance principles, and an asset-weighted aggregation is performed as a second step. Moreover, for certain types of securities, which finance specific projects contributing to environmental or social objectives the overall investment is considered to contribute to environmental and/or social objectives, but also for these a DNSH as well as a Good Governance check for issuers is performed.

● **How do the sustainable investments that the financial product partially intends to make, not cause significant harm to any environmental or social sustainable investment objective?**

In order to ensure that Sustainable Investments do not significantly harm any other environmental and/or social objective, the Investment Manager is leveraging the PAI indicators, whereby significance thresholds have been defined to identify significantly harmful issuers. Issuers not meeting the significance threshold can be engaged for a limited time period to remediate the adverse impact. Otherwise, if the issuer does not meet the defined significance thresholds twice subsequently or in case of a failed engagement, it does not pass the DNSH assessment. Investments in securities of issuers which do not pass the DNSH assessment are not counted as sustainable investments.

● **How have the indicators for adverse impacts on sustainability factors been taken into account?**

All mandatory PAI indicators are considered either as part of the application of the exclusion criteria or through thresholds on a sectorial or absolute basis. Significance thresholds have been defined and they refer to qualitative or quantitative criteria.

Recognizing the lack of data coverage for some of the PAI indicators equivalent data points are used to assess PAI indicators when applying the DNSH assessment, when relevant, for the following indicators for corporates: share of non-renewable energy consumption and production, activities negatively affecting biodiversity-sensitive areas, emissions to water, lack of processes and compliance mechanisms to monitor compliance with UNGC principles and OECD Guidelines for Multinational Enterprises; for sovereigns: GHG Intensity and investee countries subject to social violations. In case of securities which

Principal adverse impacts are the most significant negative impacts of investment decisions on sustainability factors relating to environmental, social and employee matters, respect for human rights, anti-corruption and anti-bribery matters.

finance specific projects contributing to environmental or social objectives equivalent data at project level might be used to ensure that Sustainable Investments do not significantly harm any other environmental and/or social objective. The Investment Manager will strive to increase data coverage for PAI indicators with low data coverage by engaging with issuers and data providers. The Investment Manager will regularly evaluate whether the availability of data has increased sufficiently to potentially include assessment of such data in the investment process.

- *How are the sustainable investments aligned with the OECD Guidelines for Multinational Enterprises and the UN Guiding Principles on Business and Human Rights? Details:*

The Investment Manager's sustainable minimum exclusion list screens out companies based on their involvement in controversial practices against international norms. The core normative framework consists of the Principles of the UN Global Compact, the OECD Guidelines for Multinational Enterprises and the UN Guiding Principles for Business and Human Rights. Securities issued by companies having a severe violation of these frameworks will be restricted from the investment universe.

The EU Taxonomy sets out a "do not significant harm" principle by which Taxonomy-aligned investments should not significantly harm EU Taxonomy objectives and is accompanied by specific EU criteria.

The "do not significant harm" principle applies only to those investments underlying the financial product that take into account the EU criteria for environmentally sustainable economic activities. The investments underlying the remaining portion of this financial product do not take into account the EU criteria for environmentally sustainable economic activities.

Any other sustainable investments must also not significantly harm any environmental or social objectives.



Does this financial product consider principal adverse impacts on sustainability factors?

Yes

No

The Management Company has joined the Net Zero Asset Manager Initiative and considers PAI indicators through stewardship including engagement, both are relevant to mitigate potential adverse impact as a company.

Due to the commitment to the Net Zero Asset Manager Initiative, the Management Company aims to reduce greenhouse gas emissions in partnership with asset owner clients on decarbonisation goals, consistent with an ambition to reach net zero emission by 2050 or sooner across all assets under management. As part of this objective the Management Company will set an interim target for the proportion of assets to be managed in line with the attainment of net zero emissions by 2050 or sooner.

The Sub-Fund's Investment Manager addresses PAI indicators regarding greenhouse gas emission, biodiversity, water, waste as well as social and employee matters for corporate issuers, and, where relevant, the freedom house index is applied to investments in sovereigns. PAI indicators are considered within the Investment Manager's investment process through the means of exclusions as described in the "binding elements" section of the Sub-Fund.

The data coverage for the data required for the PAI indicators is heterogenous. The data coverage related to biodiversity, water and waste is low and the related PAI indicators are considered through exclusion of securities issued by companies having a severe violation / breach of principles and guidelines such as the Principles of the United Nations Global Compact, the OECD Guidelines for Multinational Enterprises, and the United Nations Guiding Principles for Business and Human Rights on the grounds of problematic practices around human rights, labour rights, environment, and corruption issues. Therefore, the Investment Manager will strive to increase data coverage for PAI indicators with low data coverage. The Investment Manager will regularly evaluate whether the availability of data has increased sufficiently to potentially include assessment of such data in the investment process.

The following PAI indicators are considered:

Applicable to corporate issuers

- GHG Emissions
- Carbon footprint
- GHG Intensity of investee companies
- Exposure to companies active in the fossil fuel sector

- Activities negatively affecting biodiversity-sensitive areas
- Emissions to water
- Hazardous waste ratio
- Violation of UN Global compact principles
- Lack of processes and compliance mechanisms to monitor compliance with UN Global Compact principles
- Board gender diversity
- Exposure to controversial weapons

Applicable to sovereign and supranational issuers

- Investee countries subject to social violations

The information on the PAI indicators will be available in the end-year report of the Sub-Fund.



What investment strategy does this financial product follow?

The investment strategy guides investment decisions based on factors such as investment objectives and risk tolerance.

Allianz Global Multi Asset Sustainability Conservative's investment objective is to invest in a broad range of asset classes, with a focus on global equity, bond and money markets in order to achieve over the medium-term a performance comparable to a balanced portfolio consisting of 25% global equity markets and 75% global bond markets in accordance with the Multi Asset Sustainability Strategy. A Sub-Fund managed according to the Multi Asset Sustainability Strategy ("MAS Strategy") invests in (i) Equities and / or Debt Securities of companies that either provide for environmental and/or social characteristics and/or pursue activities contributing to an environmental or social objective and / or invests (ii) in Green Bonds and/or Social Bonds, and/or in Sustainability Bonds and/or (iii) in SFDR Target Funds.

In case of direct investments in Equities and/or Debt Securities, the Sub-Fund's Investment Manager may choose one or more of the below strategies that promote environmental and/or social characteristics and/or pursue activities contributing to an environmental or social objective:

- SRI Strategy

The Sub-Fund or strategy promotes environmental and social characteristics through integrating environmental, social, human rights, governance and business behaviour factors into the Sub-Fund's investment process through a best-in-class approach. This encompasses the evaluation of corporate or sovereign issuers based on an SRI Rating that it is used to construct the portfolio.

- SDG-Aligned & SDG-Aligned Type A Strategy

The Sub-Fund's or strategy's Sustainable Investment objective is to invest in Equities and/or in Debt Securities of companies providing solutions that create positive environmental and social outcomes, as assessed by the contribution of companies' outputs to the attainment of one or more of the SDGs or other Sustainable Investment objectives, which the Sub-Fund's Investment Manager may additionally determine and to which the companies contribute to.

- Green Bond Strategy

The Sub-Fund's or strategy's Sustainable Investment objective is to mobilize capital markets towards the transition to a low carbon society, natural capital preservation and adaptation to climate change. The Sub-Fund or strategy invests primarily in Green Bonds financing climate change mitigation or adaptation projects or other environmental sustainability projects, notably in the following fields: energy efficiency, renewable energy, raw materials, water and land, waste management, greenhouse gas emissions reduction, biodiversity preservation or circular economy.

- Green Transition Strategy

The Sub-Fund or strategy promotes environmental and/or social characteristics through the mobilization of capital markets towards the transition to a low carbon society, natural capital preservation and adaptation to climate change.

- KPI Strategy (Absolute Threshold)

A Sub-Fund or strategy managed according to the Sustainability Key Performance Indicator Strategy (Absolute Threshold) ("KPI Strategy (Absolute Threshold)") targets a specific minimum allocation into Sustainable Investments. Sustainable investments are investments in economic activities which contribute to environmental

and/or social objectives, for which the Investment Managers uses as reference frameworks the UN Sustainable Development Goals (SDGs), as well as the objectives of the EU Taxonomy.

The Sub-Fund's general investment approach (Sub-Fund's applicable General Asset Class Principles in combination with its individual investment restrictions) is described in the prospectus.

● **What are the binding elements of the investment strategy used to select the investments to attain each of the environmental or social characteristics promoted by this financial product?**

A Sub-Fund managed according to the Multi Asset Sustainability Strategy ("MAS Strategy") invests in (i) Equities and / or Debt Securities of companies that either provide for environmental and/or social characteristics and/or pursue activities contributing to an environmental or social objective and / or invests (ii) in Green Bonds and/or Social Bonds, and/or in Sustainability Bonds and/or (iii) in SFDR Target Funds.

Overall, the Investment Manager is required to invest min 70% of Sub-Fund's assets in SFDR Target Funds and/or in Equities and/or Debt Securities in accordance with the Multi Asset Sustainability Strategy.

- Application of the following sustainable minimum exclusion criteria for direct investments (with exception of cash, derivatives, external Target Funds, and internal Target Funds not following a sustainable strategy):
- securities issued by companies having a severe violation / breach of principles and guidelines such as the Principles of the United Nations Global Compact, the OECD Guidelines for Multinational Enterprises, and the United Nations Guiding Principles for Business and Human Rights on the grounds of problematic practices around human rights, labour rights, environment, and corruption issues,
- securities issued by companies involved in controversial weapons (anti-personnel mines, cluster munitions, chemical weapons, biological weapons, depleted uranium, white phosphorus, and nuclear weapons),
- securities issued by companies that derive more than 10% of their revenues from weapons, military equipment, and services,
- securities issued by companies that derive more than 10% of their revenue from thermal coal extraction,
- securities issued by utility companies that generate more than 20% of their revenues from coal,
- securities issued by companies involved in the production of tobacco, and securities issued by companies involved in the distribution of tobacco with more than 5% of their revenues.

Direct investments in sovereign issuers with an insufficient freedom house index score are excluded.

The sustainable minimum exclusion criteria are based on information from an external data provider and coded in pre- and post-trade compliance. The review is performed at least half yearly.

● **What is the committed minimum rate to reduce the scope of the investments considered prior to the application of that investment strategy?**

The Sub-Fund does not commit to reduce the scope of the investments by a certain minimum rate.

● **What is the policy to assess good governance practices of the investee companies?**

Good governance principles are considered by screening out companies based on their involvement in controversies around international norms corresponding to the four good governance practices: sound management structures, employee relations, remuneration of staff and tax compliance. Companies having a severe violation in either of those areas will not be investible. For certain cases, flagged issuers shall be on a watch list. These companies will appear on this watch list when the Investment Manager believes that engagement may lead to improvements or when the company is assessed to take remedial actions. Companies on the watch list remain investible unless the Investment Manager believes that the engagement or the remedial actions of the company does not lead to the desired remedy of the severe controversy.

In addition, the Sub-Fund's Investment Manager is committed to actively encourage open dialogues with investee companies on corporate governance, proxy voting and broader sustainability issues in advance of shareholder meetings (regularly for direct investments in shares). The Sub-Fund's Investment Manager's approach to proxy voting and company engagement is set out in the Management Company's Stewardship Statement.

Good governance practices include sound management structures, employee relations, remuneration of staff and tax compliance.



What is the asset allocation planned for this financial product?

Asset allocation describes the share of investments in specific assets.

Min. 70% of the Sub-Funds' assets are used to meet the environmental or social characteristics promoted by this Sub-Fund. A low portion of the Sub-Fund might contain assets which do not promote environmental or social characteristics. Example of such instruments are derivatives, cash and deposits, some Target Funds and investment with temporarily divergent or absent environmental, social, or good governance qualifications or investments outside of the specified quota to be invested as part of the Multi Asset Sustainability Strategy. Min. 1.50% of the Sub-Funds' assets will be invested in Sustainable Investments. The minimum percentage of investments that are aligned with the EU Taxonomy is 0.01%. The Sub-Fund's Investment Manager does not commit to a minimum share of environmentally Sustainable Investments that are not aligned with the EU Taxonomy. The Sub-Fund's Investment Manager does not commit to a minimum share of socially sustainable investments. While the Sub-Fund cannot commit to a minimum share of environmentally or socially sustainable investments, such investments may be freely allocated to within the Sub-Fund aggregated sustainable investment commitment disclosed (min. 1,50%).

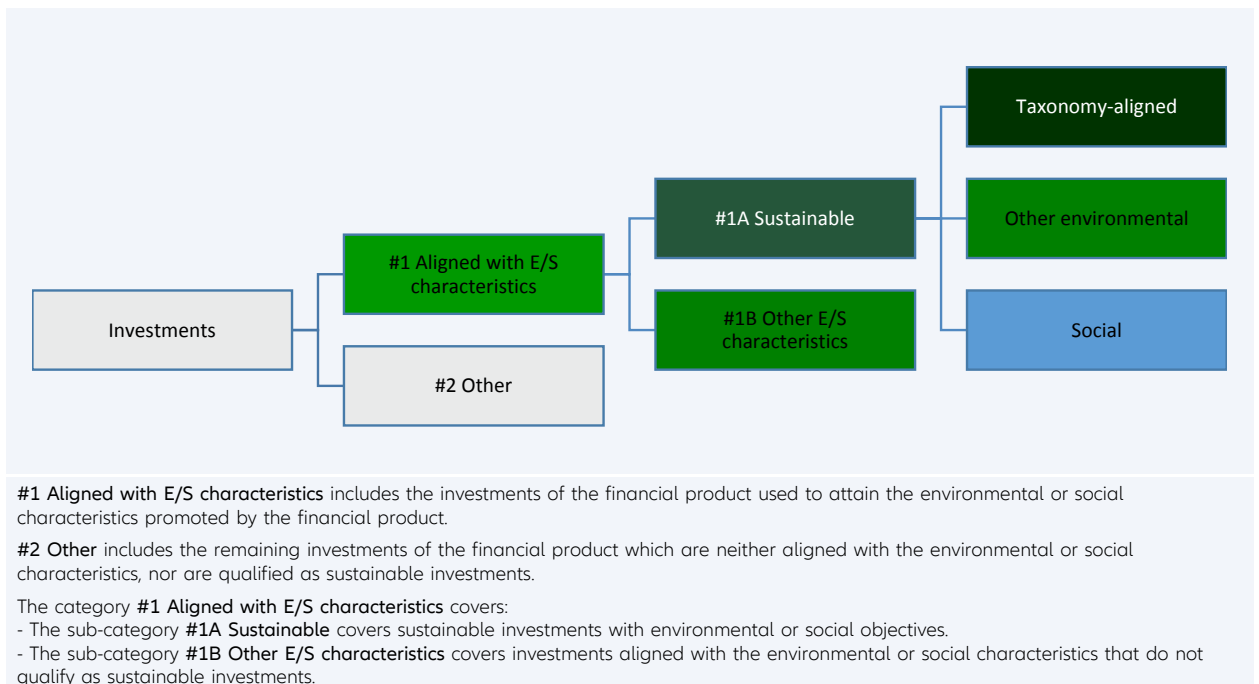

- **How does the use of derivatives attain the environmental or social characteristics promoted by the financial product?**

Not applicable



To what minimum extent are sustainable investments with an environmental objective aligned with the EU Taxonomy?

The Taxonomy-aligned investments include debt and/or equity in environmentally sustainable economic activities aligned with the EU-Taxonomy. The minimum percentage of investments that are aligned with the EU Taxonomy is 0.01%. Taxonomy-aligned data is provided by an external data provider. The Investment Manager has assessed the quality of such data. The data will not be subject to an assurance provided by auditors or a review by third parties. The data will not reflect any data in government bonds. As of today, there is no recognized methodology available to determine the proportion of Taxonomy-aligned activities when investing in government bonds.

Taxonomy-aligned activities in this disclosure are based on share of turnover. Pre-contractual figures use turnover as its financial metric as a default in line with the regulatory requirements and based on the fact that complete, verifiable or up-to date data for CAPEX and/or OPEX as financial metric is even less available.

Taxonomy-aligned data is only in rare cases data reported by companies in accordance with the EU Taxonomy. The data provider has derived Taxonomy-aligned data from other available equivalent public data.

Taxonomy-aligned activities are expressed as a share of:

- **turnover** reflecting the share of revenue from green activities of investee companies
- **capital expenditure** (CapEx) showing the green investments made by investee companies, e.g. for a transition to a green economy.
- **operational expenditure** (OpEx) reflecting green operational activities of investee companies.

● **Does the financial product invest in fossil gas and/or nuclear energy related activities that comply with the EU Taxonomy ¹?**

- Yes:
- In fossil gas
 - In nuclear energy
- No

The Sub-Fund does not pursue any investments in fossil gas and/or nuclear energy related activities that comply with the EU Taxonomy. Nevertheless, as result of this investment strategy, investments may occur in corporates which are also active in these activities. Further information will be provided as part of the annual reporting, if relevant.

The two graphs below show in green the minimum percentage of investments that are aligned with the EU Taxonomy. As there is no appropriate methodology to determine the Taxonomy-alignment of sovereign bonds*, the first graph shows the Taxonomy-alignment in relation to all the investments of the financial product including sovereign bonds, while the second graph shows the Taxonomy-alignment only in relation to the investments of the financial product other than sovereign bonds.

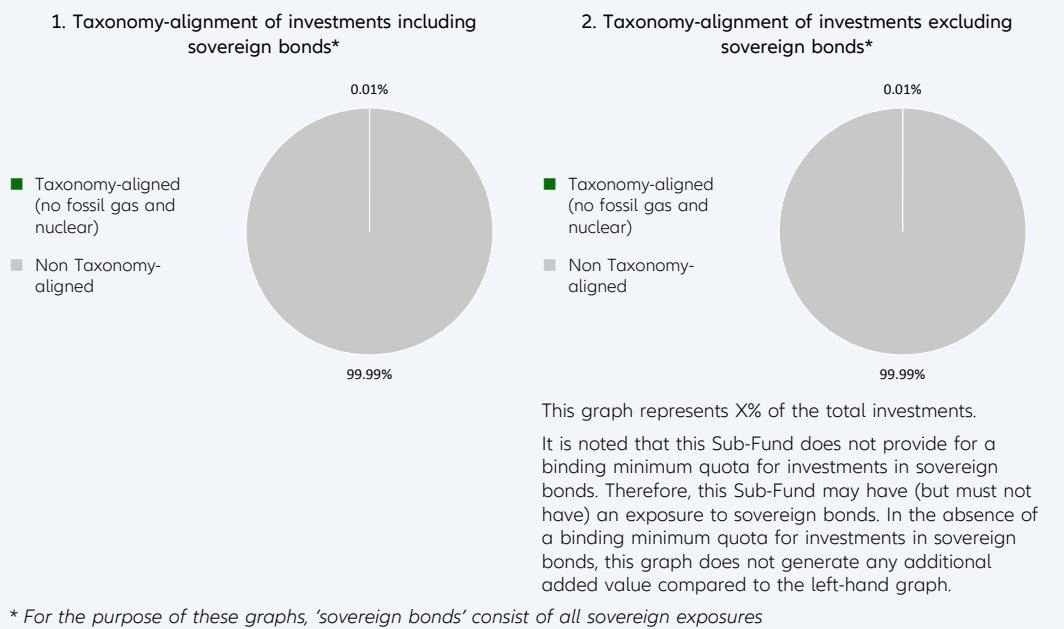

Enabling activities directly enable other activities to make a substantial contribution to an environmental objective.

● **What is the minimum share of investments in transitional and enabling activities?**

The Sub-Fund's Investment Manager does not commit to a split of minimum taxonomy alignment into transitional, enabling activities and own performance.

Transitional activities are activities for which low-carbon alternatives are not yet available and among others have greenhouse gas emission levels corresponding to the best performance.

¹ Fossil gas and/or nuclear related activities will only comply with the EU Taxonomy where they contribute to limiting climate change ("climate change mitigation") and do not significantly harm any EU Taxonomy objective - see explanatory note in the left hand margin. The full criteria for fossil gas and nuclear energy economic activities that comply with the EU Taxonomy are laid down in Commission Delegated Regulation (EU) 2022/1214.



What is the minimum share of sustainable investments with an environmental objective that are not aligned with the EU Taxonomy?

Taxonomy-aligned investments are considered a sub-category of Sustainable Investments. If an investment is not Taxonomy-aligned since the activity is not yet covered under the EU Taxonomy or the positive contribution is not substantial enough to comply with the Taxonomy technical screening criteria, the investment can still be considered an environmentally Sustainable Investment provided it complies with all criteria. The Investment Manager does not commit to a minimum share of environmentally Sustainable Investments that are not aligned with the EU Taxonomy. The overall sustainable investment share may also include investments with an environmental objective in economic activities that do not qualify as environmentally sustainable under the EU Taxonomy, and while the Sub-Fund cannot commit to a minimum share of environmentally or socially sustainable investments, such investments may be freely allocated to within the Sub-Fund aggregated sustainable investment commitment disclosed (min. 1,50%).



What is the minimum share of socially sustainable investments?

The Investment Manager defines Sustainable Investments based on internal research, which uses, among others, the UN Sustainable Development Goals (SDGs), as well as the objectives of the EU Taxonomy as reference frameworks. The Investment Manager does not commit to a minimum share of socially Sustainable Investments, as the SDGs contain environmental as well as social objectives. The overall sustainable investment share may also include investments with a social objective, and while the Sub-Fund cannot commit to a minimum share of environmentally or socially sustainable investments, such investments may be freely allocated to within the Sub-Fund aggregated sustainable investment commitment disclosed (min. 1,50%).



What investments are included under “#2 Other”, what is their purpose and are there any minimum environmental or social safeguards?

Under “#2 Other” investments into cash, Target Funds, or derivatives can be included. Derivatives might be used for efficient portfolio management (including risk hedging) and/or investment purposes, and Target Funds to benefit from a specific strategy. For those investments no environmental or social safeguards are applied.



Is a specific index designated as a reference benchmark to determine whether this financial product is aligned with the environmental and/or social characteristics that it promotes?

No reference benchmark has been designated for the purpose of attaining the environmental and/or social characteristics promoted by the Sub-Fund.

- How is the reference benchmark continuously aligned with each of the environmental or social characteristics promoted by the financial product?

Not applicable

- How is the alignment of the investment strategy with the methodology of the index ensured on a continuous basis?

Not applicable

- How does the designated index differ from a relevant broad market index?

Not applicable

- Where can the methodology used for the calculation of the designated index be found?

Not applicable



are sustainable investments with an environmental objective that **do not take into account the criteria** for environmentally sustainable economic activities under the EU Taxonomy.

Reference benchmarks are indexes to measure whether the financial product attains the environmental or social characteristics that they promote.



Where can I find more product specific information online?

More product-specific information can be found on the website: <https://regulatory.allianzgi.com/SFDR>

Template pre-contractual disclosure for the financial products referred to in Article 8, paragraphs 1, 2 and 2a, of Regulation (EU) 2019/2088 and Article 6, first paragraph, of Regulation (EU) 2020/852

Product name:

Allianz Global Multi Asset Sustainability Growth

Legal entity identifier: 549300YXK62SBLFWYH24

Environmental and/or social characteristics

Sustainable investment means an investment in an economic activity that contributes to an environmental or social objective, provided that the investment does not significantly harm any environmental or social objective and that the investee companies follow good governance practices.

The **EU Taxonomy** is a classification system laid down in Regulation (EU) 2020/852, establishing a list of **environmentally sustainable economic activities**. That Regulation does not include a list of socially sustainable economic activities. Sustainable investments with an environmental objective might be aligned with the Taxonomy or not.

Does this financial product have a sustainable investment objective?	
Yes	No
<input type="checkbox"/> It will make a minimum of sustainable investments with an environmental objective: ___% <ul style="list-style-type: none"> <input type="checkbox"/> in economic activities that qualify as environmentally sustainable under the EU Taxonomy <input type="checkbox"/> in economic activities that do not qualify as environmentally sustainable under the EU Taxonomy 	<input checked="" type="checkbox"/> It promotes Environmental/Social (E/S) characteristics and while it does not have as its objective a sustainable investment, it will have a minimum proportion of 3.00% of sustainable investments <ul style="list-style-type: none"> <input checked="" type="checkbox"/> with an environmental objective in economic activities that qualify as environmentally sustainable under the EU Taxonomy <input checked="" type="checkbox"/> with an environmental objective in economic activities that do not qualify as environmentally sustainable under the EU Taxonomy <input checked="" type="checkbox"/> with a social objective
<input type="checkbox"/> It will make a minimum of sustainable investments with a social objective ___%	<input type="checkbox"/> It promotes E/S characteristics, but will not make any sustainable investments



What environmental and/or social characteristics are promoted by this financial product?

Allianz Global Multi Asset Sustainability Growth (the "Sub-Fund") promotes a broad range of environmental and/or social characteristics. The Sub-Fund invests at least 70% of its assets following the "Multi Asset Sustainability Strategy" which includes, but is not limited to, various sustainability strategies of the management company and/or, invests in Green Bonds and/or Social Bonds, and/or Sustainability Bonds and/or SFDR Article 8 & 9 Target Funds ("SFDR Target Funds").

Depending on the sustainability strategy selected by the Investment Manager the promoted environmental and/or social characteristics could comprise environmental, social, human rights, governance, business behaviour factors or investments in companies providing solutions that create positive environmental and social outcomes.

In addition, sustainable minimum exclusion criteria apply.

No reference benchmark has been designated for the purpose of attaining the environmental and/or social characteristics promoted by the Sub-Fund.

● What sustainability indicators are used to measure the attainment of each of the environmental or social characteristics promoted by this financial product?

As part of the Multi Asset Sustainability Strategy the Investment Manager allocates at least 70% of Fund's assets in various sustainability approaches.

Sustainability indicators measure how the environmental or social characteristics promoted by the financial product are attained.

To measure the attainment of the environmental and/or social characteristics the following sustainability indicators are used and reported on, at the fiscal year end:

- The actual percentage of the Sub-Fund's assets invested in Green Bonds, and/or Social Bonds, and/or Sustainability Bonds and/or in SFDR Target Funds and/or in Equities and/or Debt Securities in accordance with the Multi Asset Sustainability Strategy.
- In case the Investment Manager decides to directly invest in Debt or Equity Securities as part of the Multi Asset Sustainability Strategy the adherence to the respective binding element will be reported.
- Confirmation that Principal Adverse Impacts (PAIs) of investment decisions on sustainability factors are considered through the application of exclusion criteria (with exception of cash, derivatives, external Target Funds and internal Target Funds not following a sustainability strategy).

● **What are the objectives of the sustainable investments that the financial product partially intends to make and how does the sustainable investment contribute to such objectives?**

Sustainable investments contribute to environmental and/or social objectives, for which the Investment Manager uses as reference frameworks, among others, the UN Sustainable Development Goals (SDGs), as well as the objectives of the EU Taxonomy:

1. Climate Change Mitigation
2. Climate Change Adaptation
3. Sustainable Use and Protection of Water and Marine Resources
4. Transition to a Circular Economy
5. Pollution Prevention and Control
6. Protection and Restoration of Biodiversity and Ecosystems

The assessment of the positive contribution to the environmental or social objectives is based on a proprietary framework which combines quantitative elements with qualitative inputs from internal research. The methodology applies first a quantitative breakdown of a securities issuer into its business activities. The qualitative element of the framework is an assessment if business activities contribute positively to an environmental or a social objective.

To calculate the positive contribution on the Sub-Fund level the revenue share of each issuer attributable to business activities contributing to environmental and/or social objectives is considered provided the issuer is satisfying the Do No Significant Harm ("DNSH") and Good Governance principles, and an asset-weighted aggregation is performed as a second step. Moreover, for certain types of securities, which finance specific projects contributing to environmental or social objectives the overall investment is considered to contribute to environmental and/or social objectives, but also for these a DNSH as well as a Good Governance check for issuers is performed.

● **How do the sustainable investments that the financial product partially intends to make, not cause significant harm to any environmental or social sustainable investment objective?**

In order to ensure that Sustainable Investments do not significantly harm any other environmental and/or social objective, the Investment Manager is leveraging the PAI indicators, whereby significance thresholds have been defined to identify significantly harmful issuers. Issuers not meeting the significance threshold can be engaged for a limited time period to remediate the adverse impact. Otherwise, if the issuer does not meet the defined significance thresholds twice subsequently or in case of a failed engagement, it does not pass the DNSH assessment. Investments in securities of issuers which do not pass the DNSH assessment are not counted as sustainable investments.

● **How have the indicators for adverse impacts on sustainability factors been taken into account?**

All mandatory PAI indicators are considered either as part of the application of the exclusion criteria or through thresholds on a sectorial or absolute basis. Significance thresholds have been defined and they refer to qualitative or quantitative criteria.

Recognizing the lack of data coverage for some of the PAI indicators equivalent data points are used to assess PAI indicators when applying the DNSH assessment, when relevant, for the following indicators for corporates: share of non-renewable energy consumption and production, activities negatively affecting biodiversity-sensitive areas, emissions to water, lack of processes and compliance mechanisms to monitor compliance with UNGC principles and OECD Guidelines for Multinational Enterprises; for sovereigns: GHG Intensity and investee countries subject to social violations. In case of securities which

Principal adverse impacts are the most significant negative impacts of investment decisions on sustainability factors relating to environmental, social and employee matters, respect for human rights, anti-corruption and anti-bribery matters.

finance specific projects contributing to environmental or social objectives equivalent data at project level might be used to ensure that Sustainable Investments do not significantly harm any other environmental and/or social objective. The Investment Manager will strive to increase data coverage for PAI indicators with low data coverage by engaging with issuers and data providers. The Investment Manager will regularly evaluate whether the availability of data has increased sufficiently to potentially include assessment of such data in the investment process.

● *How are the sustainable investments aligned with the OECD Guidelines for Multinational Enterprises and the UN Guiding Principles on Business and Human Rights? Details:*

The Investment Manager's sustainable minimum exclusion list screens out companies based on their involvement in controversial practices against international norms. The core normative framework consists of the Principles of the UN Global Compact, the OECD Guidelines for Multinational Enterprises and the UN Guiding Principles for Business and Human Rights. Securities issued by companies having a severe violation of these frameworks will be restricted from the investment universe.

The EU Taxonomy sets out a "do not significant harm" principle by which Taxonomy-aligned investments should not significantly harm EU Taxonomy objectives and is accompanied by specific EU criteria.

The "do not significant harm" principle applies only to those investments underlying the financial product that take into account the EU criteria for environmentally sustainable economic activities. The investments underlying the remaining portion of this financial product do not take into account the EU criteria for environmentally sustainable economic activities.

Any other sustainable investments must also not significantly harm any environmental or social objectives.



Does this financial product consider principal adverse impacts on sustainability factors?

Yes

No

The Management Company has joined the Net Zero Asset Manager Initiative and considers PAI indicators through stewardship including engagement, both are relevant to mitigate potential adverse impact as a company.

Due to the commitment to the Net Zero Asset Manager Initiative, the Management Company aims to reduce greenhouse gas emissions in partnership with asset owner clients on decarbonisation goals, consistent with an ambition to reach net zero emission by 2050 or sooner across all assets under management. As part of this objective the Management Company will set an interim target for the proportion of assets to be managed in line with the attainment of net zero emissions by 2050 or sooner.

The Sub-Fund's Investment Manager addresses PAI indicators regarding greenhouse gas emission, biodiversity, water, waste as well as social and employee matters for corporate issuers, and, where relevant, the freedom house index is applied to investments in sovereigns. PAI indicators are considered within the Investment Manager's investment process through the means of exclusions as described in the "binding elements" section of the Sub-Fund.

The data coverage for the data required for the PAI indicators is heterogenous. The data coverage related to biodiversity, water and waste is low and the related PAI indicators are considered through exclusion of securities issued by companies having a severe violation / breach of principles and guidelines such as the Principles of the United Nations Global Compact, the OECD Guidelines for Multinational Enterprises, and the United Nations Guiding Principles for Business and Human Rights on the grounds of problematic practices around human rights, labour rights, environment, and corruption issues. Therefore, the Investment Manager will strive to increase data coverage for PAI indicators with low data coverage. The Investment Manager will regularly evaluate whether the availability of data has increased sufficiently to potentially include assessment of such data in the investment process.

The following PAI indicators are considered:

Applicable to corporate issuers

- GHG Emissions
- Carbon footprint
- GHG Intensity of investee companies
- Exposure to companies active in the fossil fuel sector

- Activities negatively affecting biodiversity-sensitive areas
- Emissions to water
- Hazardous waste ratio
- Violation of UN Global compact principles
- Lack of processes and compliance mechanisms to monitor compliance with UN Global Compact principles
- Board gender diversity
- Exposure to controversial weapons

Applicable to sovereign and supranational issuers

- Investee countries subject to social violations

The information on the PAI indicators will be available in the end-year report of the Sub-Fund.



What investment strategy does this financial product follow?

The investment strategy guides investment decisions based on factors such as investment objectives and risk tolerance.

Allianz Global Multi Asset Sustainability Growth's investment objective is to invest in a broad range of asset classes, with a focus on global equity, bond and money markets in order to achieve over the medium-term a performance comparable to a balanced portfolio consisting of 75% global equity markets and 25% global bond markets in accordance with the Multi Asset Sustainability Strategy. A Sub-Fund managed according to the Multi Asset Sustainability Strategy ("MAS Strategy") invests in (i) Equities and / or Debt Securities of companies that either provide for environmental and/or social characteristics and/or pursue activities contributing to an environmental or social objective and / or invests (ii) in Green Bonds and/or Social Bonds, and/or in Sustainability Bonds and/or (iii) in SFDR Target Funds.

In case of direct investments in Equities and/or Debt Securities, the Sub-Fund's Investment Manager may choose one or more of the below strategies that promote environmental and/or social characteristics and/or pursue activities contributing to an environmental or social objective:

- SRI Strategy

The Sub-Fund or strategy promotes environmental and social characteristics through integrating environmental, social, human rights, governance and business behaviour factors into the Sub-Fund's investment process through a best-in-class approach. This encompasses the evaluation of corporate or sovereign issuers based on an SRI Rating that it is used to construct the portfolio.

- SDG-Aligned & SDG-Aligned Type A Strategy

The Sub-Fund's or strategy's Sustainable Investment objective is to invest in Equities and/or in Debt Securities of companies providing solutions that create positive environmental and social outcomes, as assessed by the contribution of companies' outputs to the attainment of one or more of the SDGs or other Sustainable Investment objectives, which the Sub-Fund's Investment Manager may additionally determine and to which the companies contribute to.

- Green Bond Strategy

The Sub-Fund's or strategy's Sustainable Investment objective is to mobilize capital markets towards the transition to a low carbon society, natural capital preservation and adaptation to climate change. The Sub-Fund or strategy invests primarily in Green Bonds financing climate change mitigation or adaptation projects or other environmental sustainability projects, notably in the following fields: energy efficiency, renewable energy, raw materials, water and land, waste management, greenhouse gas emissions reduction, biodiversity preservation or circular economy.

- Green Transition Strategy

The Sub-Fund or strategy promotes environmental and/or social characteristics through the mobilization of capital markets towards the transition to a low carbon society, natural capital preservation and adaptation to climate change.

- KPI Strategy (Absolute Threshold)

A Sub-Fund or strategy managed according to the Sustainability Key Performance Indicator Strategy (Absolute Threshold) ("KPI Strategy (Absolute Threshold)") targets a specific minimum allocation into Sustainable Investments. Sustainable investments are investments in economic activities which contribute to environmental

and/or social objectives, for which the Investment Managers uses as reference frameworks the UN Sustainable Development Goals (SDGs), as well as the objectives of the EU Taxonomy.

The Sub-Fund's general investment approach (Sub-Fund's applicable General Asset Class Principles in combination with its individual investment restrictions) is described in the prospectus.

● **What are the binding elements of the investment strategy used to select the investments to attain each of the environmental or social characteristics promoted by this financial product?**

A Sub-Fund managed according to the Multi Asset Sustainability Strategy ("MAS Strategy") invests in (i) Equities and / or Debt Securities of companies that either provide for environmental and/or social characteristics and/or pursue activities contributing to an environmental or social objective and / or invests (ii) in Green Bonds and/or Social Bonds, and/or in Sustainability Bonds and/or (iii) in SFDR Target Funds.

Overall, the Investment Manager is required to invest min 70% of Sub-Fund's assets in SFDR Target Funds and/or in Equities and/or Debt Securities in accordance with the Multi Asset Sustainability Strategy.

- Application of the following sustainable minimum exclusion criteria for direct investments (with exception of cash, derivatives, external Target Funds, and internal Target Funds not following a sustainable strategy):
- securities issued by companies having a severe violation / breach of principles and guidelines such as the Principles of the United Nations Global Compact, the OECD Guidelines for Multinational Enterprises, and the United Nations Guiding Principles for Business and Human Rights on the grounds of problematic practices around human rights, labour rights, environment, and corruption issues,
- securities issued by companies involved in controversial weapons (anti-personnel mines, cluster munitions, chemical weapons, biological weapons, depleted uranium, white phosphorus, and nuclear weapons),
- securities issued by companies that derive more than 10% of their revenues from weapons, military equipment, and services,
- securities issued by companies that derive more than 10% of their revenue from thermal coal extraction,
- securities issued by utility companies that generate more than 20% of their revenues from coal,
- securities issued by companies involved in the production of tobacco, and securities issued by companies involved in the distribution of tobacco with more than 5% of their revenues.

Direct investments in sovereign issuers with an insufficient freedom house index score are excluded.

The sustainable minimum exclusion criteria are based on information from an external data provider and coded in pre- and post-trade compliance. The review is performed at least half yearly.

● **What is the committed minimum rate to reduce the scope of the investments considered prior to the application of that investment strategy?**

The Sub-Fund does not commit to reduce the scope of the investments by a certain minimum rate.

● **What is the policy to assess good governance practices of the investee companies?**

Good governance principles are considered by screening out companies based on their involvement in controversies around international norms corresponding to the four good governance practices: sound management structures, employee relations, remuneration of staff and tax compliance. Companies having a severe violation in either of those areas will not be investible. For certain cases, flagged issuers shall be on a watch list. These companies will appear on this watch list when the Investment Manager believes that engagement may lead to improvements or when the company is assessed to take remedial actions. Companies on the watch list remain investible unless the Investment Manager believes that the engagement or the remedial actions of the company does not lead to the desired remedy of the severe controversy.

In addition, the Sub-Fund's Investment Manager is committed to actively encourage open dialogues with investee companies on corporate governance, proxy voting and broader sustainability issues in advance of shareholder meetings (regularly for direct investments in shares). The Sub-Fund's Investment Manager's approach to proxy voting and company engagement is set out in the Management Company's Stewardship Statement.

Good governance practices include sound management structures, employee relations, remuneration of staff and tax compliance.



What is the asset allocation planned for this financial product?

Asset allocation describes the share of investments in specific assets.

Min. 70% of the Sub-Funds' assets are used to meet the environmental or social characteristics promoted by this Sub-Fund. A low portion of the Sub-Fund might contain assets which do not promote environmental or social characteristics. Example of such instruments are derivatives, cash and deposits, some Target Funds and investment with temporarily divergent or absent environmental, social, or good governance qualifications or investments outside of the specified quota to be invested as part of the Multi Asset Sustainability Strategy. Min. 3% of the Sub-Funds' assets will be invested in Sustainable Investments. The minimum percentage of investments that are aligned with the EU Taxonomy is 0.01%. The Sub-Fund's Investment Manager does not commit to a minimum share of environmentally Sustainable Investments that are not aligned with the EU Taxonomy. The Sub-Fund's Investment Manager does not commit to a minimum share of socially sustainable investments. While the Sub-Fund cannot commit to a minimum share of environmentally or socially sustainable investments, such investments may be freely allocated to within the Sub-Fund aggregated sustainable investment commitment disclosed (min. 3%).

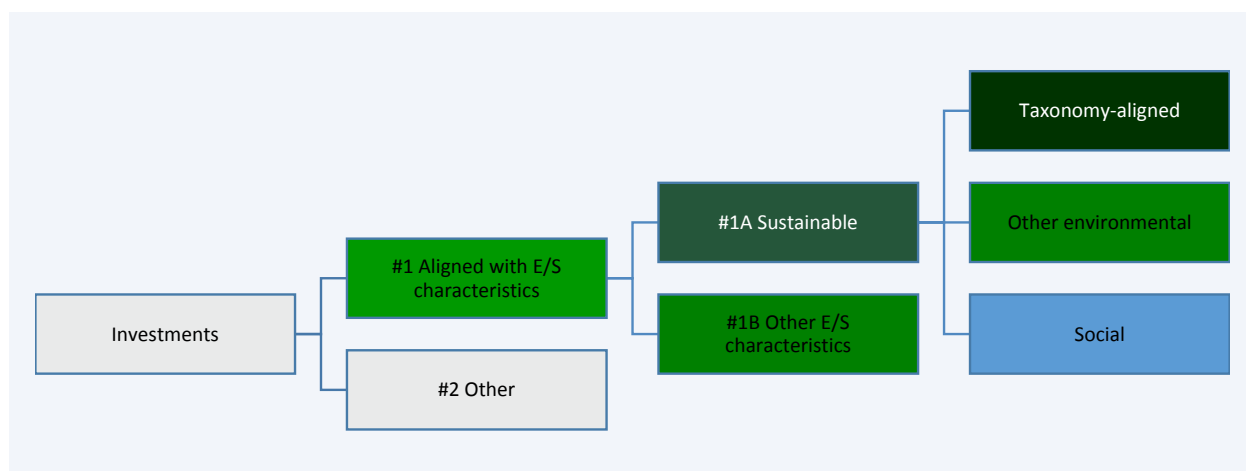

#1 Aligned with E/S characteristics includes the investments of the financial product used to attain the environmental or social characteristics promoted by the financial product.

#2 Other includes the remaining investments of the financial product which are neither aligned with the environmental or social characteristics, nor are qualified as sustainable investments.

The category **#1 Aligned with E/S characteristics** covers:

- The sub-category **#1A Sustainable** covers sustainable investments with environmental or social objectives.
- The sub-category **#1B Other E/S characteristics** covers investments aligned with the environmental or social characteristics that do not qualify as sustainable investments.

● **How does the use of derivatives attain the environmental or social characteristics promoted by the financial product?**

Not applicable



To what minimum extent are sustainable investments with an environmental objective aligned with the EU Taxonomy?

The Taxonomy-aligned investments include debt and/or equity in environmentally sustainable economic activities aligned with the EU-Taxonomy. The minimum percentage of investments that are aligned with the EU Taxonomy is 0.01%. Taxonomy-aligned data is provided by an external data provider. The Investment Manager has assessed the quality of such data. The data will not be subject to an assurance provided by auditors or a review by third parties. The data will not reflect any data in government bonds. As of today, there is no recognized methodology available to determine the proportion of Taxonomy-aligned activities when investing in government bonds.

Taxonomy-aligned activities in this disclosure are based on share of turnover. Pre-contractual figures use turnover as its financial metric as a default in line with the regulatory requirements and based on the fact that complete, verifiable or up-to date data for CAPEX and/or OPEX as financial metric is even less available.

Taxonomy-aligned data is only in rare cases data reported by companies in accordance with the EU Taxonomy. The data provider has derived Taxonomy-aligned data from other available equivalent public data.

Taxonomy-aligned activities are expressed as a share of:
 - **turnover** reflecting the share of revenue from green activities of investee companies
 - **capital expenditure** (CapEx) showing the green investments made by investee companies, e.g. for a transition to a green economy.
 - **operational expenditure** (OpEx) reflecting green operational activities of investee companies.

● **Does the financial product invest in fossil gas and/or nuclear energy related activities that comply with the EU Taxonomy ¹?**

- Yes:
 In fossil gas In nuclear energy
- No

The Sub-Fund does not pursue any investments in fossil gas and/or nuclear energy related activities that comply with the EU Taxonomy. Nevertheless, as result of this investment strategy, investments may occur in corporates which are also active in these activities. Further information will be provided as part of the annual reporting, if relevant.

The two graphs below show in green the minimum percentage of investments that are aligned with the EU Taxonomy. As there is no appropriate methodology to determine the Taxonomy-alignment of sovereign bonds, the first graph shows the Taxonomy-alignment in relation to all the investments of the financial product including sovereign bonds, while the second graph shows the Taxonomy-alignment only in relation to the investments of the financial product other than sovereign bonds.*

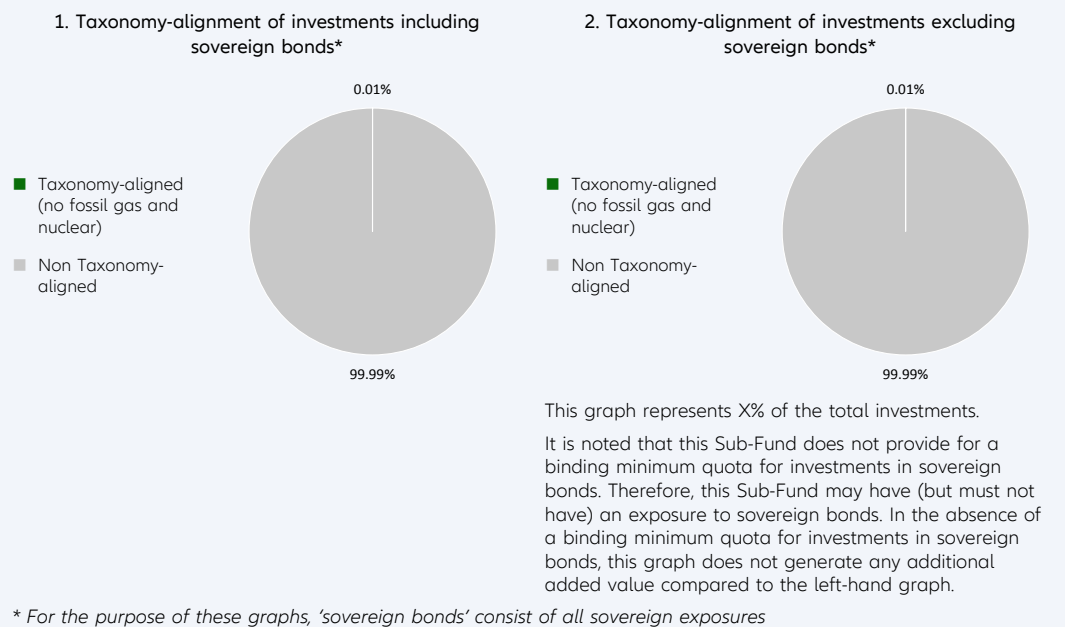

Enabling activities directly enable other activities to make a substantial contribution to an environmental objective.

Transitional activities are activities for which low-carbon alternatives are not yet available and among others have greenhouse gas emission levels corresponding to the best performance.

● **What is the minimum share of investments in transitional and enabling activities?**

The Sub-Fund's Investment Manager does not commit to a split of minimum taxonomy alignment into transitional, enabling activities and own performance.

¹ Fossil gas and/or nuclear related activities will only comply with the EU Taxonomy where they contribute to limiting climate change ("climate change mitigation") and do not significantly harm any EU Taxonomy objective - see explanatory note in the left hand margin. The full criteria for fossil gas and nuclear energy economic activities that comply with the EU Taxonomy are laid down in Commission Delegated Regulation (EU) 2022/1214.



What is the minimum share of sustainable investments with an environmental objective that are not aligned with the EU Taxonomy?

Taxonomy-aligned investments are considered a sub-category of Sustainable Investments. If an investment is not Taxonomy-aligned since the activity is not yet covered under the EU Taxonomy or the positive contribution is not substantial enough to comply with the Taxonomy technical screening criteria, the investment can still be considered an environmentally Sustainable Investment provided it complies with all criteria. The Investment Manager does not commit to a minimum share of environmentally Sustainable Investments that are not aligned with the EU Taxonomy. The overall sustainable investment share may also include investments with an environmental objective in economic activities that do not qualify as environmentally sustainable under the EU Taxonomy, and while the Sub-Fund cannot commit to a minimum share of environmentally or socially sustainable investments, such investments may be freely allocated to within the Sub-Fund aggregated sustainable investment commitment disclosed (min. 3%).



are sustainable investments with an environmental objective that **do not take into account the criteria** for environmentally sustainable economic activities under the EU Taxonomy.



What is the minimum share of socially sustainable investments?

The Investment Manager defines Sustainable Investments based on internal research, which uses, among others, the UN Sustainable Development Goals (SDGs), as well as the objectives of the EU Taxonomy as reference frameworks. The Investment Manager does not commit to a minimum share of socially Sustainable Investments, as the SDGs contain environmental as well as social objectives. The overall sustainable investment share may also include investments with a social objective, and while the Sub-Fund cannot commit to a minimum share of environmentally or socially sustainable investments, such investments may be freely allocated to within the Sub-Fund aggregated sustainable investment commitment disclosed (min. 3%).



What investments are included under “#2 Other”, what is their purpose and are there any minimum environmental or social safeguards?

Under “#2 Other” investments into cash, Target Funds, or derivatives can be included. Derivatives might be used for efficient portfolio management (including risk hedging) and/or investment purposes, and Target Funds to benefit from a specific strategy. For those investments no environmental or social safeguards are applied.



Is a specific index designated as a reference benchmark to determine whether this financial product is aligned with the environmental and/or social characteristics that it promotes?

No reference benchmark has been designated for the purpose of attaining the environmental and/or social characteristics promoted by the Sub-Fund.

Reference benchmarks are indexes to measure whether the financial product attains the environmental or social characteristics that they promote.

- **How is the reference benchmark continuously aligned with each of the environmental or social characteristics promoted by the financial product?**
Not applicable
- **How is the alignment of the investment strategy with the methodology of the index ensured on a continuous basis?**
Not applicable
- **How does the designated index differ from a relevant broad market index?**
Not applicable
- **Where can the methodology used for the calculation of the designated index be found?**
Not applicable



Where can I find more product specific information online?

More product-specific information can be found on the website: <https://regulatory.allianzgi.com/SFDR>

Template pre-contractual disclosure for the financial products referred to in Article 8, paragraphs 1, 2 and 2a, of Regulation (EU) 2019/2088 and Article 6, first paragraph, of Regulation (EU) 2020/852

Product name:

Allianz Global Multi-Asset Credit

Legal entity identifier: 549300KHQG2E3AS5HS50

Environmental and/or social characteristics

Sustainable investment means an investment in an economic activity that contributes to an environmental or social objective, provided that the investment does not significantly harm any environmental or social objective and that the investee companies follow good governance practices.

The **EU Taxonomy** is a classification system laid down in Regulation (EU) 2020/852, establishing a list of **environmentally sustainable economic activities**. That Regulation does not include a list of socially sustainable economic activities. Sustainable investments with an environmental objective might be aligned with the Taxonomy or not.

Does this financial product have a sustainable investment objective?	
<input checked="" type="radio"/> <input checked="" type="radio"/> Yes	<input checked="" type="radio"/> <input type="radio"/> No
<input type="checkbox"/> It will make a minimum of sustainable investments with an environmental objective: ___% <ul style="list-style-type: none"> <input type="checkbox"/> in economic activities that qualify as environmentally sustainable under the EU Taxonomy <input type="checkbox"/> in economic activities that do not qualify as environmentally sustainable under the EU Taxonomy 	<input checked="" type="checkbox"/> It promotes Environmental/Social (E/S) characteristics and while it does not have as its objective a sustainable investment, it will have a minimum proportion of 10.00% of sustainable investments <ul style="list-style-type: none"> <input checked="" type="checkbox"/> with an environmental objective in economic activities that qualify as environmentally sustainable under the EU Taxonomy <input checked="" type="checkbox"/> with an environmental objective in economic activities that do not qualify as environmentally sustainable under the EU Taxonomy <input checked="" type="checkbox"/> with a social objective
<input type="checkbox"/> It will make a minimum of sustainable investments with a social objective ___%	<input type="checkbox"/> It promotes E/S characteristics, but will not make any sustainable investments



What environmental and/or social characteristics are promoted by this financial product?

Allianz Global Multi-Asset Credit (the "Sub-Fund") promotes environmental, social, human rights, governance, and business behaviour factors (this domain does not apply for sovereigns issued by a Sovereign Entity) through integration of a best-in-class approach into the Sub-Fund's investment process. This encompasses the evaluation of corporate or sovereign issuers based on an SRI Rating which is used to construct the portfolio.

In addition, sustainable minimum exclusion criteria applies.

No reference benchmark has been designated for the purpose of attaining the environmental and/or social characteristics promoted by the Sub-Fund.

● What sustainability indicators are used to measure the attainment of each of the environmental or social characteristics promoted by this financial product?

To measure the attainment of the environmental and/or social characteristics the following sustainability indicators are used and reported on, at the fiscal year end:

- The actual percentage of the Sub-Fund's Portfolio (Portfolio in this respect does not comprise non-rated derivatives and instruments that are non-rated by nature (e. g., cash and deposits)) assets invested in best-in-class issuers (issuers with a minimum SRI Rating of 2 out of a scale from 0-4; 0 being the worst rating and 4 the best rating).
- Confirmation that Principal Adverse Impacts (PAIs) of investment decisions on sustainability factors are considered through the application of exclusion criteria.

● **What are the objectives of the sustainable investments that the financial product partially intends to make and how does the sustainable investment contribute to such objectives?**

Sustainable investments contribute to environmental and/or social objectives, for which the Investment Manager uses as reference frameworks, among others, the UN Sustainable Development Goals (SDGs), as well as the objectives of the EU Taxonomy:

1. Climate Change Mitigation
2. Climate Change Adaptation
3. Sustainable Use and Protection of Water and Marine Resources
4. Transition to a Circular Economy
5. Pollution Prevention and Control
6. Protection and Restoration of Biodiversity and Ecosystems

The assessment of the positive contribution to the environmental or social objectives is based on a proprietary framework which combines quantitative elements with qualitative inputs from internal research. The methodology applies first a quantitative breakdown of a securities issuer into its business activities. The qualitative element of the framework is an assessment if business activities contribute positively to an environmental or a social objective.

To calculate the positive contribution on the Sub-Fund level the revenue share of each issuer attributable to business activities contributing to environmental and/or social objectives is considered provided the issuer is satisfying the Do No Significant Harm (“DNSH”) and Good Governance principles, and an asset-weighted aggregation is performed as a second step. Moreover, for certain types of securities, which finance specific projects contributing to environmental or social objectives the overall investment is considered to contribute to environmental and/or social objectives, but also for these a DNSH as well as a Good Governance check for issuers is performed.

● **How do the sustainable investments that the financial product partially intends to make, not cause significant harm to any environmental or social sustainable investment objective?**

In order to ensure that Sustainable Investments do not significantly harm any other environmental and/or social objective, the Investment Manager is leveraging the PAI indicators, whereby significance thresholds have been defined to identify significantly harmful issuers. Issuers not meeting the significance threshold can be engaged for a limited time period to remediate the adverse impact. Otherwise, if the issuer does not meet the defined significance thresholds twice subsequently or in case of a failed engagement, it does not pass the DNSH assessment. Investments in securities of issuers which do not pass the DNSH assessment are not counted as sustainable investments.

● *How have the indicators for adverse impacts on sustainability factors been taken into account?*

All mandatory PAI indicators are considered either as part of the application of the exclusion criteria or through thresholds on a sectorial or absolute basis. Significance thresholds have been defined and they refer to qualitative or quantitative criteria.

Recognizing the lack of data coverage for some of the PAI indicators equivalent data points are used to assess PAI indicators when applying the DNSH assessment, when relevant, for the following indicators for corporates: share of non-renewable energy consumption and production, activities negatively affecting biodiversity-sensitive areas, emissions to water, lack of processes and compliance mechanisms to monitor compliance with UNGC principles and OECD Guidelines for Multinational Enterprises; for sovereigns: GHG Intensity and investee countries subject to social violations. In case of securities which finance specific projects contributing to environmental or social objectives equivalent data at project level might be used to ensure that Sustainable Investments do not significantly harm any other environmental and/or social objective. The Investment Manager will strive to increase data coverage for PAI indicators with low data coverage by engaging with issuers and data providers. The Investment Manager will regularly evaluate whether the availability of data has increased sufficiently to potentially include assessment of such data in the investment process.

● *How are the sustainable investments aligned with the OECD Guidelines for Multinational Enterprises and the UN Guiding Principles on Business and Human Rights? Details:*

The Investment Manager’s sustainable minimum exclusion list screens out companies based on their involvement in controversial practices against international norms. The core normative framework consists of the Principles of the UN Global Compact, the OECD Guidelines for Multinational Enterprises

Principal adverse impacts are the most significant negative impacts of investment decisions on sustainability factors relating to environmental, social and employee matters, respect for human rights, anti-corruption and anti-bribery matters.

and the UN Guiding Principles for Business and Human Rights. Securities issued by companies having a severe violation of these frameworks will be restricted from the investment universe.

The EU Taxonomy sets out a “do not significant harm” principle by which Taxonomy-aligned investments should not significantly harm EU Taxonomy objectives and is accompanied by specific EU criteria.

The “do not significant harm” principle applies only to those investments underlying the financial product that take into account the EU criteria for environmentally sustainable economic activities. The investments underlying the remaining portion of this financial product do not take into account the EU criteria for environmentally sustainable economic activities.

Any other sustainable investments must also not significantly harm any environmental or social objectives.



Does this financial product consider principal adverse impacts on sustainability factors?

Yes

No

The Management Company has joined the Net Zero Asset Manager Initiative and considers PAI indicators through stewardship including engagement, both are relevant to mitigate potential adverse impact as a company.

Due to the commitment to the Net Zero Asset Manager Initiative, the Management Company aims to reduce greenhouse gas emissions in partnership with asset owner clients on decarbonisation goals, consistent with an ambition to reach net zero emission by 2050 or sooner across all assets under management. As part of this objective the Management Company will set an interim target for the proportion of assets to be managed in line with the attainment of net zero emissions by 2050 or sooner.

The Sub-Fund’s Investment Manager considers PAI indicators regarding greenhouse gas emission, biodiversity, water, waste as well as social and employee matters for corporate issuers, and, where relevant, the freedom house index is applied to investments in sovereigns. PAI indicators are considered within the Investment Manager’s investment process through the means of exclusions as described in the “binding elements” section of the Sub-Fund.

The data coverage for the data required for the PAI indicators is heterogenous. The data coverage related to biodiversity, water and waste is low and the related PAI indicators are considered through exclusion of securities issued by companies having a severe violation / breach of principles and guidelines such as the Principles of the United Nations Global Compact, the OECD Guidelines for Multinational Enterprises, and the United Nations Guiding Principles for Business and Human Rights on the grounds of problematic practices around human rights, labour rights, environment, and corruption issues. Therefore, the Investment Manager will strive to increase data coverage for PAI indicators with low data coverage. The Investment Manager will regularly evaluate whether the availability of data has increased sufficiently to potentially include assessment of such data in the investment process.

Additionally, PAI indicators are, among other sustainability factors, applied to derive the SRI Rating. The SRI Rating is used for the portfolio construction.

The following PAI indicators are considered:

Applicable to corporate issuers

- GHG Emissions
- Carbon footprint
- GHG Intensity of investee companies
- Exposure to companies active in the fossil fuel sector
- Activities negatively affecting biodiversity-sensitive areas
- Emissions to water
- Hazardous waste ratio
- Violation of UN Global compact principles
- Lack of processes and compliance mechanisms to monitor compliance with UN Global Compact principles
- Board gender diversity
- Exposure to controversial weapons

Applicable to sovereign and supranational issuers

- Investee countries subject to social violations

The information on the PAI indicators will be available in the end-year report of the Sub-Fund.



What investment strategy does this financial product follow?

The investment strategy guides investment decisions based on factors such as investment objectives and risk tolerance.

Allianz Global Multi-Asset Credit's investment objective is to invest in global Bond Markets in accordance with the Sustainable and Responsible Investment Strategy (SRI Strategy).

As part of the SRI best-in-class approach, the Sub-Fund takes environmental, social, human rights, governance, and business behaviour factors into account as follows:

- The aforesaid sustainability factors are analysed through SRI Research by the Investment Manager in order to assess how sustainable development and long-term issues are taken into account in the strategy of an issuer. SRI Research means the overall process of identifying potential risks as well as potential opportunities of an investment in securities of an issuer related to the analysis of sustainability factors. SRI Research data combines external research data (which might have some limitations) with internal analyses.
- Based on a combination of the results of the external and/or internal analyses of the sustainability factors, an internal rating is derived monthly (SRI Rating) and is afterwards assigned to a corporate or sovereign issuer.

This internal SRI Rating is used to rank and select or weight securities for the portfolio construction.

The Sub-Fund's general investment approach (Sub-Fund's applicable General Asset Class Principles in combination with its individual investment restrictions) is described in the prospectus.

● What are the binding elements of the investment strategy used to select the investments to attain each of the environmental or social characteristics promoted by this financial product?

The binding elements are:

- Minimum rating coverage: At least 70% of the Sub-Fund's portfolio is required to have an SRI Rating (portfolio in this respect does not comprise non-rated derivatives and instruments that are non-rated by nature e.g., cash and deposits). While most holdings of the Sub-Fund will have a corresponding SRI Rating some investments cannot be rated according to the SRI Research methodology. Examples of instruments not attaining to the SRI Rating include, but are not limited to cash, deposits, Target Funds, and non-rated investments.
- 80% of the rated instruments are adhering to the minimum rating threshold of 1,75 (out of a rating scale from 0 – 4; 0 being the worst rating and 4 the best rating).
- Application of the below sustainable minimum exclusion criteria for direct investments.

The following sustainable minimum exclusion criteria for direct investments apply:

- securities issued by companies having a severe violation / breach of principles and guidelines such as the Principles of the United Nations Global Compact, the OECD Guidelines for Multinational Enterprises, and the United Nations Guiding Principles for Business and Human Rights on the grounds of problematic practices around human rights, labour rights, environment, and corruption issues,
- securities issued by companies involved in controversial weapons (anti-personnel mines, cluster munitions, chemical weapons, biological weapons, depleted uranium, white phosphorus, and nuclear weapons),
- securities issued by companies that derive more than 10% of their revenues from weapons, military equipment, and services,
- securities issued by companies that derive more than 10% of their revenue from thermal coal extraction,
- securities issued by utility companies that generate more than 20% of their revenues from coal,
- securities issued by companies involved in the production of tobacco, and securities issued by companies involved in the distribution of tobacco with more than 5% of their revenues.

Direct investments in sovereign issuers with an insufficient freedom house index score are excluded.

The sustainable minimum exclusion criteria, as well as the Sub-Fund specific exclusion criteria, are based on information from an external data provider and coded in pre- and post-trade compliance. The review is performed at least half yearly.

- **What is the committed minimum rate to reduce the scope of the investments considered prior to the application of that investment strategy?**

The Sub-Fund does not commit to reduce the scope of the investments by a certain minimum rate.

- **What is the policy to assess good governance practices of the investee companies?**

Good governance principles are considered by screening out companies based on their involvement in controversies around international norms corresponding to the four good governance practices: sound management structures, employee relations, remuneration of staff and tax compliance. Companies having a severe violation in either of those areas will not be investible. For certain cases, flagged issuers shall be on a watch list. These companies will appear on this watch list when the Investment Manager believes that engagement may lead to improvements or when the company is assessed to take remedial actions. Companies on the watch list remain investible unless the Investment Manager believes that the engagement or the remedial actions of the company does not lead to the desired remedy of the severe controversy.

In addition, the Sub-Fund's Investment Manager is committed to actively encourage open dialogues with investee companies on corporate governance, proxy voting and broader sustainability issues in advance of shareholder meetings (regularly for direct investments in shares). The Sub-Fund's Investment Manager's approach to proxy voting and company engagement is set out in the Management Company's Stewardship Statement.

Good governance practices include sound management structures, employee relations, remuneration of staff and tax compliance.



What is the asset allocation planned for this financial product?

Asset allocation describes the share of investments in specific assets.

Min. 70% of the Sub-Funds' assets (excluding cash and non-rated derivatives) are used to meet the environmental or social characteristics promoted by this Sub-Fund. A low portion of the Sub-Fund might contain assets which do not promote environmental or social characteristics. Examples of such instruments are derivatives, cash and deposits, some Target Funds and investment with temporarily divergent or absent environmental, social, or good governance qualifications. Min. 10% of the Sub-Funds' assets will be invested in Sustainable Investments. The minimum percentage of investments that are aligned with the EU Taxonomy is 0.01%. The Sub-Fund's Investment Manager does not commit to a minimum share of environmentally Sustainable Investments that are not aligned with the EU Taxonomy. The Sub-Fund's Investment Manager does not commit to a minimum share of socially sustainable investments. While the Sub-Fund cannot commit to a minimum share of environmentally or socially sustainable investments, such investments may be freely allocated to within the Sub-Fund aggregated sustainable investment commitment disclosed (min. 10%).

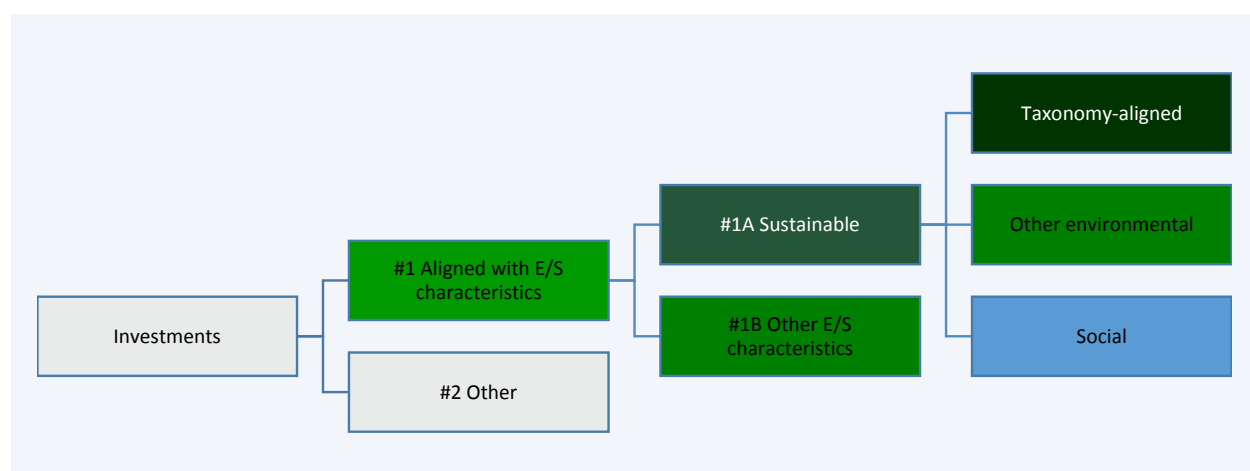

#1 Aligned with E/S characteristics includes the investments of the financial product used to attain the environmental or social characteristics promoted by the financial product.

#2 Other includes the remaining investments of the financial product which are neither aligned with the environmental or social characteristics, nor are qualified as sustainable investments.

The category **#1 Aligned with E/S characteristics** covers:

- The sub-category **#1A Sustainable** covers sustainable investments with environmental or social objectives.

- The sub-category #1B Other E/S characteristics covers investments aligned with the environmental or social characteristics that do not qualify as sustainable investments.

- **How does the use of derivatives attain the environmental or social characteristics promoted by the financial product?**

Not applicable



To what minimum extent are sustainable investments with an environmental objective aligned with the EU Taxonomy?

The Taxonomy-aligned investments include debt and/or equity in environmentally sustainable economic activities aligned with the EU-Taxonomy. The minimum percentage of investments that are aligned with the EU Taxonomy is 0.01%. Taxonomy-aligned data is provided by an external data provider. The Investment Manager has assessed the quality of such data. The data will not be subject to an assurance provided by auditors or a review by third parties. The data will not reflect any data in government bonds. As of today, there is no recognized methodology available to determine the proportion of Taxonomy-aligned activities when investing in government bonds.

Taxonomy-aligned activities in this disclosure are based on share of turnover. Pre-contractual figures use turnover as its financial metric as a default in line with the regulatory requirements and based on the fact that complete, verifiable or up-to date data for CAPEX and/or OPEX as financial metric is even less available.

Taxonomy-aligned data is only in rare cases data reported by companies in accordance with the EU Taxonomy. The data provider has derived Taxonomy-aligned data from other available equivalent public data.

- **Does the financial product invest in fossil gas and/or nuclear energy related activities that comply with the EU Taxonomy ¹?**

Yes:

In fossil gas In nuclear energy

No

The Sub-Fund does not pursue any investments in fossil gas and/or nuclear energy related activities that comply with the EU Taxonomy. Nevertheless, as result of this investment strategy, investments may occur in corporates which are also active in these activities. Further information will be provided as part of the annual reporting, if relevant.

The two graphs below show in green the minimum percentage of investments that are aligned with the EU Taxonomy. As there is no appropriate methodology to determine the Taxonomy-alignment of sovereign bonds*, the first graph shows the Taxonomy-alignment in relation to all the investments of the financial product including sovereign bonds, while the second graph shows the Taxonomy-alignment only in relation to the investments of the financial product other than sovereign bonds.

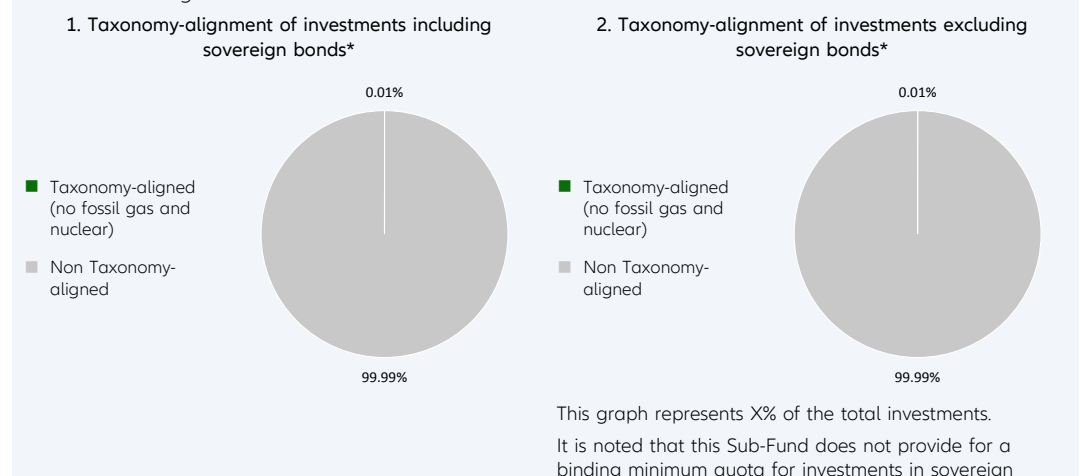

¹ Fossil gas and/or nuclear related activities will only comply with the EU Taxonomy where they contribute to limiting climate change ("climate change mitigation") and do not significantly harm any EU Taxonomy objective - see explanatory note in the left hand margin. The full criteria for fossil gas and nuclear energy economic activities that comply with the EU Taxonomy are laid down in Commission Delegated Regulation (EU) 2022/1214.

bonds. Therefore, this Sub-Fund may have (but must not have) an exposure to sovereign bonds. In the absence of a binding minimum quota for investments in sovereign bonds, this graph does not generate any additional added value compared to the left-hand graph.

** For the purpose of these graphs, 'sovereign bonds' consist of all sovereign exposures*

Enabling activities directly enable other activities to make a substantial contribution to an environmental objective.

Transitional activities are activities for which low-carbon alternatives are not yet available and among others have greenhouse gas emission levels corresponding to the best performance.

● **What is the minimum share of investments in transitional and enabling activities?**

The Sub-Fund's Investment Manager does not commit to a split of minimum taxonomy alignment into transitional, enabling activities and own performance.



What is the minimum share of sustainable investments with an environmental objective that are not aligned with the EU Taxonomy?

Taxonomy-aligned investments are considered a sub-category of Sustainable Investments. If an investment is not Taxonomy-aligned since the activity is not yet covered under the EU Taxonomy or the positive contribution is not substantial enough to comply with the Taxonomy technical screening criteria, the investment can still be considered an environmentally Sustainable Investment provided it complies with all criteria. The Investment Manager does not commit to a minimum share of environmentally Sustainable Investments that are not aligned with the EU Taxonomy. The overall sustainable investment share may also include investments with an environmental objective in economic activities that do not qualify as environmentally sustainable under the EU Taxonomy, and while the Sub-Fund cannot commit to a minimum share of environmentally or socially sustainable investments, such investments may be freely allocated to within the Sub-Fund aggregated sustainable investment commitment disclosed (min. 10%).



are sustainable investments with an environmental objective that **do not take into account the criteria** for environmentally sustainable economic activities under the EU Taxonomy.



What is the minimum share of socially sustainable investments?

The Investment Manager defines Sustainable Investments based on internal research, which uses, among others, the UN Sustainable Development Goals (SDGs), as well as the objectives of the EU Taxonomy as reference frameworks. The Investment Manager does not commit to a minimum share of socially Sustainable Investments, as the SDGs contain environmental as well as social objectives. The overall sustainable investment share may also include investments with a social objective, and while the Sub-Fund cannot commit to a minimum share of environmentally or socially sustainable investments, such investments may be freely allocated to within the Sub-Fund aggregated sustainable investment commitment disclosed (min. 10%).



What investments are included under “#2 Other”, what is their purpose and are there any minimum environmental or social safeguards?

Under “#2 Other” investments into cash, Target Funds, or derivatives can be included. Derivatives might be used for efficient portfolio management (including risk hedging) and/or investment purposes, and Target Funds to benefit from a specific strategy. For those investments no environmental or social safeguards are applied.



Is a specific index designated as a reference benchmark to determine whether this financial product is aligned with the environmental and/or social characteristics that it promotes?

No reference benchmark has been designated for the purpose of attaining the environmental and/or social characteristics promoted by the Sub-Fund.

Reference benchmarks are indexes to measure whether the financial product attains the environmental or social characteristics that they promote.

- **How is the reference benchmark continuously aligned with each of the environmental or social characteristics promoted by the financial product?**
Not applicable
- **How is the alignment of the investment strategy with the methodology of the index ensured on a continuous basis?**
Not applicable
- **How does the designated index differ from a relevant broad market index?**
Not applicable
- **Where can the methodology used for the calculation of the designated index be found?**
Not applicable



Where can I find more product specific information online?

More product-specific information can be found on the website: <https://regulatory.allianzgi.com/SFDR>

Template pre-contractual disclosure for the financial products referred to in Article 8, paragraphs 1, 2 and 2a, of Regulation (EU) 2019/2088 and Article 6, first paragraph, of Regulation (EU) 2020/852

Product name:

Allianz Global Multi-Asset Credit SRI

Legal entity identifier: 529900DL5GK0L1U4FS47

Environmental and/or social characteristics

Sustainable investment means an investment in an economic activity that contributes to an environmental or social objective, provided that the investment does not significantly harm any environmental or social objective and that the investee companies follow good governance practices.

The **EU Taxonomy** is a classification system laid down in Regulation (EU) 2020/852, establishing a list of **environmentally sustainable economic activities**. That Regulation does not include a list of socially sustainable economic activities. Sustainable investments with an environmental objective might be aligned with the Taxonomy or not.

Does this financial product have a sustainable investment objective?	
<input checked="" type="radio"/> <input checked="" type="radio"/> Yes	<input checked="" type="radio"/> <input type="radio"/> No
<input type="checkbox"/> It will make a minimum of sustainable investments with an environmental objective: ___% <ul style="list-style-type: none"> <input type="checkbox"/> in economic activities that qualify as environmentally sustainable under the EU Taxonomy <input type="checkbox"/> in economic activities that do not qualify as environmentally sustainable under the EU Taxonomy 	<input checked="" type="checkbox"/> It promotes Environmental/Social (E/S) characteristics and while it does not have as its objective a sustainable investment, it will have a minimum proportion of 5.00% of sustainable investments <ul style="list-style-type: none"> <input checked="" type="checkbox"/> with an environmental objective in economic activities that qualify as environmentally sustainable under the EU Taxonomy <input checked="" type="checkbox"/> with an environmental objective in economic activities that do not qualify as environmentally sustainable under the EU Taxonomy <input checked="" type="checkbox"/> with a social objective
<input type="checkbox"/> It will make a minimum of sustainable investments with a social objective ___%	<input type="checkbox"/> It promotes E/S characteristics, but will not make any sustainable investments



What environmental and/or social characteristics are promoted by this financial product?

Allianz Global Multi-Asset Credit SRI (the "Sub-Fund") promotes environmental, social, human rights, governance, and business behaviour factors (this domain does not apply for sovereigns issued by a Sovereign Entity) through integration of a best-in-class approach into the Sub-Fund's investment process. This encompasses the evaluation of corporate or sovereign issuers based on an SRI Rating which is used to construct the portfolio.

In addition, sustainable minimum exclusion criteria and Sub-Fund specific exclusion criteria apply.

No reference benchmark has been designated for the purpose of attaining the environmental and/or social characteristics promoted by the Sub-Fund.

● What sustainability indicators are used to measure the attainment of each of the environmental or social characteristics promoted by this financial product?

To measure the attainment of the environmental and/or social characteristics the following sustainability indicators are used and reported on, at the fiscal year end:

- The actual percentage of the Sub-Fund's Portfolio (Portfolio in this respect does not comprise non-rated derivatives and instruments that are non-rated by nature (e. g., cash and deposits)) assets invested in best-in-class issuers (issuers with a minimum SRI Rating of 2 out of a scale from 0-4; 0 being the worst rating and 4 the best rating).
- Confirmation that Principal Adverse Impacts (PAIs) of investment decisions on sustainability factors are considered through the application of exclusion criteria.

● **What are the objectives of the sustainable investments that the financial product partially intends to make and how does the sustainable investment contribute to such objectives?**

Sustainable investments contribute to environmental and/or social objectives, for which the Investment Manager uses as reference frameworks, among others, the UN Sustainable Development Goals (SDGs), as well as the objectives of the EU Taxonomy:

1. Climate Change Mitigation
2. Climate Change Adaptation
3. Sustainable Use and Protection of Water and Marine Resources
4. Transition to a Circular Economy
5. Pollution Prevention and Control
6. Protection and Restoration of Biodiversity and Ecosystems

The assessment of the positive contribution to the environmental or social objectives is based on a proprietary framework which combines quantitative elements with qualitative inputs from internal research. The methodology applies first a quantitative breakdown of a securities issuer into its business activities. The qualitative element of the framework is an assessment if business activities contribute positively to an environmental or a social objective.

To calculate the positive contribution on the Sub-Fund level the revenue share of each issuer attributable to business activities contributing to environmental and/or social objectives is considered provided the issuer is satisfying the Do No Significant Harm (“DNSH”) and Good Governance principles, and an asset-weighted aggregation is performed as a second step. Moreover, for certain types of securities, which finance specific projects contributing to environmental or social objectives the overall investment is considered to contribute to environmental and/or social objectives, but also for these a DNSH as well as a Good Governance check for issuers is performed.

● **How do the sustainable investments that the financial product partially intends to make, not cause significant harm to any environmental or social sustainable investment objective?**

In order to ensure that Sustainable Investments do not significantly harm any other environmental and/or social objective, the Investment Manager is leveraging the PAI indicators, whereby significance thresholds have been defined to identify significantly harmful issuers. Issuers not meeting the significance threshold can be engaged for a limited time period to remediate the adverse impact. Otherwise, if the issuer does not meet the defined significance thresholds twice subsequently or in case of a failed engagement, it does not pass the DNSH assessment. Investments in securities of issuers which do not pass the DNSH assessment are not counted as sustainable investments.

● *How have the indicators for adverse impacts on sustainability factors been taken into account?*

All mandatory PAI indicators are considered either as part of the application of the exclusion criteria or through thresholds on a sectorial or absolute basis. Significance thresholds have been defined and they refer to qualitative or quantitative criteria.

Recognizing the lack of data coverage for some of the PAI indicators equivalent data points are used to assess PAI indicators when applying the DNSH assessment, when relevant, for the following indicators for corporates: share of non-renewable energy consumption and production, activities negatively affecting biodiversity-sensitive areas, emissions to water, lack of processes and compliance mechanisms to monitor compliance with UNGC principles and OECD Guidelines for Multinational Enterprises; for sovereigns: GHG Intensity and investee countries subject to social violations. In case of securities which finance specific projects contributing to environmental or social objectives equivalent data at project level might be used to ensure that Sustainable Investments do not significantly harm any other environmental and/or social objective. The Investment Manager will strive to increase data coverage for PAI indicators with low data coverage by engaging with issuers and data providers. The Investment Manager will regularly evaluate whether the availability of data has increased sufficiently to potentially include assessment of such data in the investment process.

● *How are the sustainable investments aligned with the OECD Guidelines for Multinational Enterprises and the UN Guiding Principles on Business and Human Rights? Details:*

The Investment Manager’s sustainable minimum exclusion list screens out companies based on their involvement in controversial practices against international norms. The core normative framework consists of the Principles of the UN Global Compact, the OECD Guidelines for Multinational Enterprises

Principal adverse impacts are the most significant negative impacts of investment decisions on sustainability factors relating to environmental, social and employee matters, respect for human rights, anti-corruption and anti-bribery matters.

and the UN Guiding Principles for Business and Human Rights. Securities issued by companies having a severe violation of these frameworks will be restricted from the investment universe.

The EU Taxonomy sets out a “do not significant harm” principle by which Taxonomy-aligned investments should not significantly harm EU Taxonomy objectives and is accompanied by specific EU criteria.

The “do not significant harm” principle applies only to those investments underlying the financial product that take into account the EU criteria for environmentally sustainable economic activities. The investments underlying the remaining portion of this financial product do not take into account the EU criteria for environmentally sustainable economic activities.

Any other sustainable investments must also not significantly harm any environmental or social objectives.



Does this financial product consider principal adverse impacts on sustainability factors?

Yes

No

The Management Company has joined the Net Zero Asset Manager Initiative and considers PAI indicators through stewardship including engagement, both are relevant to mitigate potential adverse impact as a company.

Due to the commitment to the Net Zero Asset Manager Initiative, the Management Company aims to reduce greenhouse gas emissions in partnership with asset owner clients on decarbonisation goals, consistent with an ambition to reach net zero emission by 2050 or sooner across all assets under management. As part of this objective the Management Company will set an interim target for the proportion of assets to be managed in line with the attainment of net zero emissions by 2050 or sooner.

The Sub-Fund’s Investment Manager considers PAI indicators regarding greenhouse gas emission, biodiversity, water, waste as well as social and employee matters for corporate issuers, and, where relevant, the freedom house index is applied to investments in sovereigns. PAI indicators are considered within the Investment Manager’s investment process through the means of exclusions as described in the “binding elements” section of the Sub-Fund.

The data coverage for the data required for the PAI indicators is heterogenous. The data coverage related to biodiversity, water and waste is low and the related PAI indicators are considered through exclusion of securities issued by companies having a severe violation / breach of principles and guidelines such as the Principles of the United Nations Global Compact, the OECD Guidelines for Multinational Enterprises, and the United Nations Guiding Principles for Business and Human Rights on the grounds of problematic practices around human rights, labour rights, environment, and corruption issues. Therefore, the Investment Manager will strive to increase data coverage for PAI indicators with low data coverage. The Investment Manager will regularly evaluate whether the availability of data has increased sufficiently to potentially include assessment of such data in the investment process.

Additionally, PAI indicators are, among other sustainability factors, applied to derive the SRI Rating. The SRI Rating is used for the portfolio construction.

The following PAI indicators are considered:

Applicable to corporate issuers

- GHG Emissions
- Carbon footprint
- GHG Intensity of investee companies
- Exposure to companies active in the fossil fuel sector
- Activities negatively affecting biodiversity-sensitive areas
- Emissions to water
- Hazardous waste ratio
- Violation of UN Global compact principles
- Lack of processes and compliance mechanisms to monitor compliance with UN Global Compact principles
- Board gender diversity
- Exposure to controversial weapons

Applicable to sovereign and supranational issuers

- Investee countries subject to social violations

The information on the PAI indicators will be available in the end-year report of the Sub-Fund.



What investment strategy does this financial product follow?

The investment strategy guides investment decisions based on factors such as investment objectives and risk tolerance.

Allianz Global Multi-Asset Credit SRI's investment objective is to invest in global Bond Markets in accordance with the Sustainable and Responsible Investment Strategy (SRI Strategy).

As part of the SRI best-in-class approach, the Sub-Fund takes environmental, social, human rights, governance, and business behaviour factors into account as follows:

- The aforesaid sustainability factors are analysed through SRI Research by the Investment Manager in order to assess how sustainable development and long-term issues are taken into account in the strategy of an issuer. SRI Research means the overall process of identifying potential risks as well as potential opportunities of an investment in securities of an issuer related to the analysis of sustainability factors. SRI Research data combines external research data (which might have some limitations) with internal analyses.
- Based on a combination of the results of the external and/or internal analyses of the sustainability factors, an internal rating is derived monthly (SRI Rating) and is afterwards assigned to a corporate or sovereign issuer.

This internal SRI Rating is used to rank and select or weight securities for the portfolio construction.

The Sub-Fund's general investment approach (Sub-Fund's applicable General Asset Class Principles in combination with its individual investment restrictions) is described in the prospectus.

● What are the binding elements of the investment strategy used to select the investments to attain each of the environmental or social characteristics promoted by this financial product?

The binding elements are:

- Minimum rating coverage: At least 70% of the Sub-Fund's portfolio is required to have an SRI Rating (portfolio in this respect does not comprise non-rated derivatives and instruments that are non-rated by nature e.g., cash and deposits). While most holdings of the Sub-Fund will have a corresponding SRI Rating some investments cannot be rated according to the SRI Research methodology. Examples of instruments not attaining to the SRI Rating include, but are not limited to cash, deposits, Target Funds, and non-rated investments.
- 80% of the rated instruments are adhering to the minimum rating threshold of 1,75 (out of a rating scale from 0 – 4; 0 being the worst rating and 4 the best rating).
- Application of the below sustainable minimum exclusion criteria for direct investments and Sub-Fund specific exclusion criteria.

The following sustainable minimum exclusion criteria for direct investments apply:

- securities issued by companies having a severe violation / breach of principles and guidelines such as the Principles of the United Nations Global Compact, the OECD Guidelines for Multinational Enterprises, and the United Nations Guiding Principles for Business and Human Rights on the grounds of problematic practices around human rights, labour rights, environment, and corruption issues,
- securities issued by companies involved in controversial weapons (anti-personnel mines, cluster munitions, chemical weapons, biological weapons, depleted uranium, white phosphorus, and nuclear weapons),
- securities issued by companies that derive more than 10% of their revenues from weapons, military equipment, and services,
- securities issued by companies that derive more than 10% of their revenue from thermal coal extraction,
- securities issued by utility companies that generate more than 20% of their revenues from coal,
- securities issued by companies involved in the production of tobacco, and securities issued by companies involved in the distribution of tobacco with more than 5% of their revenues.

The following Sub-Fund specific exclusion criteria for direct investments apply:

- Sub-Fund assets may not be invested in Debt Securities of issuers which provide services in relation to tobacco of more than 10% of their revenues
- Sub-fund assets may not be invested in Debt Securities of issuers which are involved in the production of gambling and/or pornography and/or which are involved in the distribution/sales of gambling and/or pornography of more than 10% of their revenues and/or which provide services in relation to gambling and/or pornography of more than 10% of their revenues
- Sub-fund assets may not be invested in Debt Securities of issuers which are involved in the production of non-conventional oil and gas and/or which provide services in relation to non-conventional oil and gas of more than 10% of their revenues
- Sub-fund assets may not be invested in Debt Securities of issuers which are involved in the production of alcohol and/or which are involved in the distribution/sales of alcohol of more than 10% of their revenues and/or which provide services in relation to alcohol of more than 20% of their revenues

Direct investments in sovereign issuers with an insufficient freedom house index score are excluded.

The sustainable minimum exclusion criteria, as well as the Sub-Fund specific exclusion criteria, are based on information from an external data provider and coded in pre- and post-trade compliance. The review is performed at least half yearly.

● **What is the committed minimum rate to reduce the scope of the investments considered prior to the application of that investment strategy?**

The Sub-Fund does not commit to reduce the scope of the investments by a certain minimum rate.

● **What is the policy to assess good governance practices of the investee companies?**

Good governance principles are considered by screening out companies based on their involvement in controversies around international norms corresponding to the four good governance practices: sound management structures, employee relations, remuneration of staff and tax compliance. Companies having a severe violation in either of those areas will not be investible. For certain cases, flagged issuers shall be on a watch list. These companies will appear on this watch list when the Investment Manager believes that engagement may lead to improvements or when the company is assessed to take remedial actions. Companies on the watch list remain investible unless the Investment Manager believes that the engagement or the remedial actions of the company does not lead to the desired remedy of the severe controversy.

In addition, the Sub-Fund's Investment Manager is committed to actively encourage open dialogues with investee companies on corporate governance, proxy voting and broader sustainability issues in advance of shareholder meetings (regularly for direct investments in shares). The Sub-Fund's Investment Manager's approach to proxy voting and company engagement is set out in the Management Company's Stewardship Statement.

Good governance practices include sound management structures, employee relations, remuneration of staff and tax compliance.



What is the asset allocation planned for this financial product?

Asset allocation describes the share of investments in specific assets.

Min. 70% of the Sub-Funds' assets (excluding cash and non-rated derivatives) are used to meet the environmental or social characteristics promoted by this Sub-Fund. A low portion of the Sub-Fund might contain assets which do not promote environmental or social characteristics. Examples of such instruments are derivatives, cash and deposits, some Target Funds and investment with temporarily divergent or absent environmental, social, or good governance qualifications. Min. 5% of the Sub-Funds' assets will be invested in Sustainable Investments. The minimum percentage of investments that are aligned with the EU Taxonomy is 0.01%. The Sub-Fund's Investment Manager does not commit to a minimum share of environmentally Sustainable Investments that are not aligned with the EU Taxonomy. The Sub-Fund's Investment Manager does not commit to a minimum share of socially sustainable investments. While the Sub-Fund cannot commit to a minimum share of environmentally or socially sustainable investments, such investments may be freely allocated to within the Sub-Fund aggregated sustainable investment commitment disclosed (min. 5%).

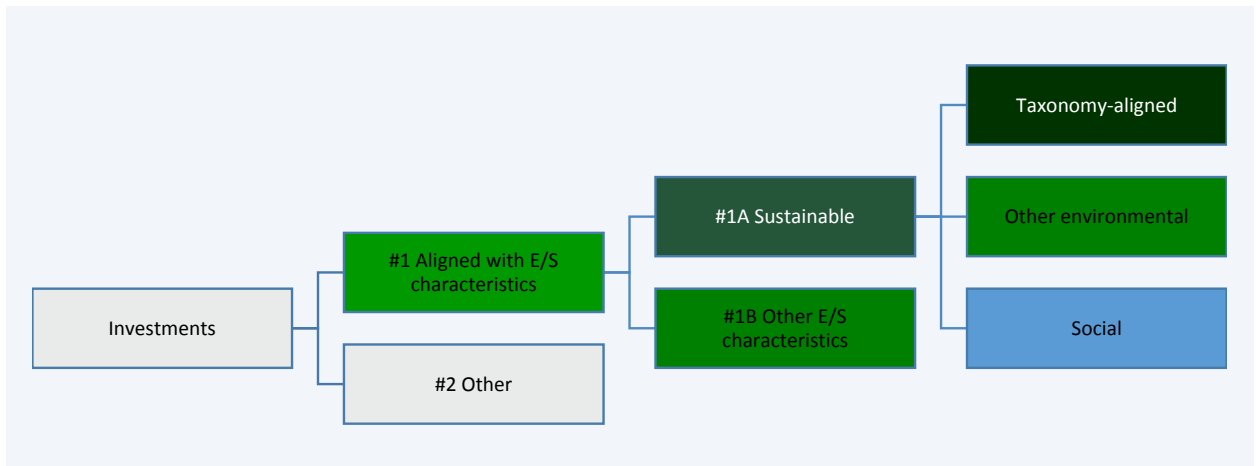

#1 Aligned with E/S characteristics includes the investments of the financial product used to attain the environmental or social characteristics promoted by the financial product.

#2 Other includes the remaining investments of the financial product which are neither aligned with the environmental or social characteristics, nor are qualified as sustainable investments.

The category **#1 Aligned with E/S characteristics** covers:

- The sub-category **#1A Sustainable** covers sustainable investments with environmental or social objectives.
- The sub-category **#1B Other E/S characteristics** covers investments aligned with the environmental or social characteristics that do not qualify as sustainable investments.

- **How does the use of derivatives attain the environmental or social characteristics promoted by the financial product?**

Not applicable



To what minimum extent are sustainable investments with an environmental objective aligned with the EU Taxonomy?

The Taxonomy-aligned investments include debt and/or equity in environmentally sustainable economic activities aligned with the EU-Taxonomy. The minimum percentage of investments that are aligned with the EU Taxonomy is 0.01%. Taxonomy-aligned data is provided by an external data provider. The Investment Manager has assessed the quality of such data. The data will not be subject to an assurance provided by auditors or a review by third parties. The data will not reflect any data in government bonds. As of today, there is no recognized methodology available to determine the proportion of Taxonomy-aligned activities when investing in government bonds.

Taxonomy-aligned activities in this disclosure are based on share of turnover. Pre-contractual figures use turnover as its financial metric as a default in line with the regulatory requirements and based on the fact that complete, verifiable or up-to date data for CAPEX and/or OPEX as financial metric is even less available.

Taxonomy-aligned data is only in rare cases data reported by companies in accordance with the EU Taxonomy. The data provider has derived Taxonomy-aligned data from other available equivalent public data.

- **Does the financial product invest in fossil gas and/or nuclear energy related activities that comply with the EU Taxonomy ¹?**

Yes:

In fossil gas In nuclear energy

No

The Sub-Fund does not pursue any investments in fossil gas and/or nuclear energy related activities that comply with the EU Taxonomy. Nevertheless, as result of this investment strategy, investments may occur in corporates which are also active in these activities. Further information will be provided as part of the annual reporting, if relevant.

Taxonomy-aligned activities are expressed as a share of:

- **turnover** reflecting the share of revenue from green activities of investee companies
- **capital expenditure (CapEx)** showing the green investments made by investee companies, e.g. for a transition to a green

¹ Fossil gas and/or nuclear related activities will only comply with the EU Taxonomy where they contribute to limiting climate change ("climate change mitigation") and do not significantly harm any EU Taxonomy objective - see explanatory note in the left hand margin. The full criteria for fossil gas and nuclear energy economic activities that comply with the EU Taxonomy are laid down in Commission Delegated Regulation (EU) 2022/1214.

economy.
 - **operational expenditure** (OpEx) reflecting green operational activities of investee companies.

The two graphs below show in green the minimum percentage of investments that are aligned with the EU Taxonomy. As there is no appropriate methodology to determine the Taxonomy-alignment of sovereign bonds*, the first graph shows the Taxonomy-alignment in relation to all the investments of the financial product including sovereign bonds, while the second graph shows the Taxonomy-alignment only in relation to the investments of the financial product other than sovereign bonds.

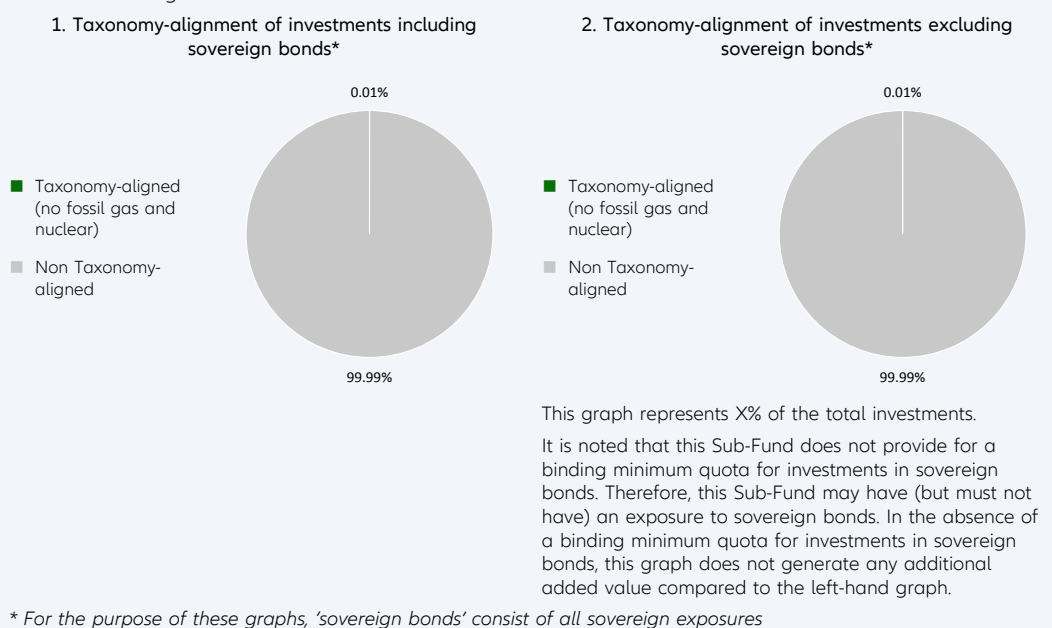

Enabling activities directly enable other activities to make a substantial contribution to an environmental objective.

Transitional activities are activities for which low-carbon alternatives are not yet available and among others have greenhouse gas emission levels corresponding to the best performance.

● **What is the minimum share of investments in transitional and enabling activities?**

The Sub-Fund's Investment Manager does not commit to a split of minimum taxonomy alignment into transitional, enabling activities and own performance.



What is the minimum share of sustainable investments with an environmental objective that are not aligned with the EU Taxonomy?

Taxonomy-aligned investments are considered a sub-category of Sustainable Investments. If an investment is not Taxonomy-aligned since the activity is not yet covered under the EU Taxonomy or the positive contribution is not substantial enough to comply with the Taxonomy technical screening criteria, the investment can still be considered an environmentally Sustainable Investment provided it complies with all criteria. The Investment Manager does not commit to a minimum share of environmentally Sustainable Investments that are not aligned with the EU Taxonomy. The overall sustainable investment share may also include investments with an environmental objective in economic activities that do not qualify as environmentally sustainable under the EU Taxonomy, and while the Sub-Fund cannot commit to a minimum share of environmentally or socially sustainable investments, such investments may be freely allocated to within the Sub-Fund aggregated sustainable investment commitment disclosed (min. 5%).

are sustainable investments with an environmental objective that **do not take into account the criteria** for environmentally sustainable economic activities under the EU Taxonomy.



What is the minimum share of socially sustainable investments?

The Investment Manager defines Sustainable Investments based on internal research, which uses, among others, the UN Sustainable Development Goals (SDGs), as well as the objectives of the EU Taxonomy as reference frameworks. The Investment Manager does not commit to a minimum share of socially Sustainable Investments, as the SDGs contain environmental as well as social objectives. The overall sustainable investment share may also include investments with a social objective, and while the Sub-Fund cannot commit to a minimum share of environmentally or socially sustainable investments, such investments may be freely allocated to within the Sub-Fund aggregated sustainable investment commitment disclosed (min. 5%).



What investments are included under “#2 Other”, what is their purpose and are there any minimum environmental or social safeguards?

Under “#2 Other” investments into cash, Target Funds, or derivatives can be included. Derivatives might be used for efficient portfolio management (including risk hedging) and/or investment purposes, and Target Funds to benefit from a specific strategy. For those investments no environmental or social safeguards are applied.



Is a specific index designated as a reference benchmark to determine whether this financial product is aligned with the environmental and/or social characteristics that it promotes?

No reference benchmark has been designated for the purpose of attaining the environmental and/or social characteristics promoted by the Sub-Fund.

Reference benchmarks are indexes to measure whether the financial product attains the environmental or social characteristics that they promote.

- **How is the reference benchmark continuously aligned with each of the environmental or social characteristics promoted by the financial product?**
Not applicable
- **How is the alignment of the investment strategy with the methodology of the index ensured on a continuous basis?**
Not applicable
- **How does the designated index differ from a relevant broad market index?**
Not applicable
- **Where can the methodology used for the calculation of the designated index be found?**
Not applicable



Where can I find more product specific information online?

More product-specific information can be found on the website: <https://regulatory.allianzgi.com/SFDR>

Template pre-contractual disclosure for the financial products referred to in Article 8, paragraphs 1, 2 and 2a, of Regulation (EU) 2019/2088 and Article 6, first paragraph, of Regulation (EU) 2020/852

Product name:

Allianz Global Sustainability

Legal entity identifier: 529900W68IN4IJ546R85

Environmental and/or social characteristics

Sustainable investment means an investment in an economic activity that contributes to an environmental or social objective, provided that the investment does not significantly harm any environmental or social objective and that the investee companies follow good governance practices.

The **EU Taxonomy** is a classification system laid down in Regulation (EU) 2020/852, establishing a list of **environmentally sustainable economic activities**. That Regulation does not include a list of socially sustainable economic activities. Sustainable investments with an environmental objective might be aligned with the Taxonomy or not.

Does this financial product have a sustainable investment objective?	
<input checked="" type="radio"/> <input checked="" type="radio"/> Yes	<input checked="" type="radio"/> <input type="radio"/> No
<input type="checkbox"/> It will make a minimum of sustainable investments with an environmental objective: ___% <ul style="list-style-type: none"> <input type="checkbox"/> in economic activities that qualify as environmentally sustainable under the EU Taxonomy <input type="checkbox"/> in economic activities that do not qualify as environmentally sustainable under the EU Taxonomy 	<input checked="" type="checkbox"/> It promotes Environmental/Social (E/S) characteristics and while it does not have as its objective a sustainable investment, it will have a minimum proportion of 20.00% of sustainable investments <ul style="list-style-type: none"> <input checked="" type="checkbox"/> with an environmental objective in economic activities that qualify as environmentally sustainable under the EU Taxonomy <input checked="" type="checkbox"/> with an environmental objective in economic activities that do not qualify as environmentally sustainable under the EU Taxonomy <input checked="" type="checkbox"/> with a social objective
<input type="checkbox"/> It will make a minimum of sustainable investments with a social objective ___%	<input type="checkbox"/> It promotes E/S characteristics, but will not make any sustainable investments



What environmental and/or social characteristics are promoted by this financial product?

Allianz Global Sustainability (the "Sub-Fund") promotes environmental, social, human rights, governance, and business behaviour factors (this domain does not apply for sovereigns issued by a Sovereign Entity) through integration of a best-in-class approach into the Sub-Fund's investment process. This encompasses the evaluation of corporate or sovereign issuers based on an SRI Rating which is used to construct the portfolio.

In addition, sustainable minimum exclusion criteria and Sub-Fund specific exclusion criteria apply.

A reference benchmark has been designated for the purpose of attaining the environmental and/or social characteristics promoted by the Sub-Fund.

● What sustainability indicators are used to measure the attainment of each of the environmental or social characteristics promoted by this financial product?

To measure the attainment of the environmental and/or social characteristics the following sustainability indicators are used and reported on, at the fiscal year end:

- The actual percentage of the Sub-Fund's Portfolio (Portfolio in this respect does not comprise non-rated derivatives and instruments that are non-rated by nature (e. g., cash and deposits)) invested in best-in-class issuers (issuers with a minimum SRI Rating of 2 out of a scale from 0-4) is compared to the actual percentage of the benchmarks best-in-class issuers.
- Adherence to a 20% reduction of the investment universe

- Confirmation that Principal Adverse Impacts (PAIs) of investment decisions on sustainability factors are considered through the application of exclusion criteria.

● **What are the objectives of the sustainable investments that the financial product partially intends to make and how does the sustainable investment contribute to such objectives?**

Sustainable investments contribute to environmental and/or social objectives, for which the Investment Manager uses as reference frameworks, among others, the UN Sustainable Development Goals (SDGs), as well as the objectives of the EU Taxonomy:

1. Climate Change Mitigation
2. Climate Change Adaptation
3. Sustainable Use and Protection of Water and Marine Resources
4. Transition to a Circular Economy
5. Pollution Prevention and Control
6. Protection and Restoration of Biodiversity and Ecosystems

The assessment of the positive contribution to the environmental or social objectives is based on a proprietary framework which combines quantitative elements with qualitative inputs from internal research. The methodology applies first a quantitative breakdown of a securities issuer into its business activities. The qualitative element of the framework is an assessment if business activities contribute positively to an environmental or a social objective.

To calculate the positive contribution on the Sub-Fund level the revenue share of each issuer attributable to business activities contributing to environmental and/or social objectives is considered provided the issuer is satisfying the Do No Significant Harm (“DNSH”) and Good Governance principles, and an asset-weighted aggregation is performed as a second step. Moreover, for certain types of securities, which finance specific projects contributing to environmental or social objectives the overall investment is considered to contribute to environmental and/or social objectives, but also for these a DNSH as well as a Good Governance check for issuers is performed.

● **How do the sustainable investments that the financial product partially intends to make, not cause significant harm to any environmental or social sustainable investment objective?**

In order to ensure that Sustainable Investments do not significantly harm any other environmental and/or social objective, the Investment Manager is leveraging the PAI indicators, whereby significance thresholds have been defined to identify significantly harmful issuers. Issuers not meeting the significance threshold can be engaged for a limited time period to remediate the adverse impact. Otherwise, if the issuer does not meet the defined significance thresholds twice subsequently or in case of a failed engagement, it does not pass the DNSH assessment. Investments in securities of issuers which do not pass the DNSH assessment are not counted as sustainable investments.

● *How have the indicators for adverse impacts on sustainability factors been taken into account?*

All mandatory PAI indicators are considered either as part of the application of the exclusion criteria or through thresholds on a sectorial or absolute basis. Significance thresholds have been defined and they refer to qualitative or quantitative criteria.

Recognizing the lack of data coverage for some of the PAI indicators equivalent data points are used to assess PAI indicators when applying the DNSH assessment, when relevant, for the following indicators for corporates: share of non-renewable energy consumption and production, activities negatively affecting biodiversity-sensitive areas, emissions to water, lack of processes and compliance mechanisms to monitor compliance with UNGC principles and OECD Guidelines for Multinational Enterprises; for sovereigns: GHG Intensity and investee countries subject to social violations. In case of securities which finance specific projects contributing to environmental or social objectives equivalent data at project level might be used to ensure that Sustainable Investments do not significantly harm any other environmental and/or social objective. The Investment Manager will strive to increase data coverage for PAI indicators with low data coverage by engaging with issuers and data providers. The Investment Manager will regularly evaluate whether the availability of data has increased sufficiently to potentially include assessment of such data in the investment process.

Principal adverse impacts are the most significant negative impacts of investment decisions on sustainability factors relating to environmental, social and employee matters, respect for human rights, anti-corruption and anti-bribery matters.

- *How are the sustainable investments aligned with the OECD Guidelines for Multinational Enterprises and the UN Guiding Principles on Business and Human Rights? Details:*

The Investment Manager's sustainable minimum exclusion list screens out companies based on their involvement in controversial practices against international norms. The core normative framework consists of the Principles of the UN Global Compact, the OECD Guidelines for Multinational Enterprises and the UN Guiding Principles for Business and Human Rights. Securities issued by companies having a severe violation of these frameworks will be restricted from the investment universe.

The EU Taxonomy sets out a "do not significant harm" principle by which Taxonomy-aligned investments should not significantly harm EU Taxonomy objectives and is accompanied by specific EU criteria.

The "do not significant harm" principle applies only to those investments underlying the financial product that take into account the EU criteria for environmentally sustainable economic activities. The investments underlying the remaining portion of this financial product do not take into account the EU criteria for environmentally sustainable economic activities.

Any other sustainable investments must also not significantly harm any environmental or social objectives.



Does this financial product consider principal adverse impacts on sustainability factors?

Yes

No

The Management Company has joined the Net Zero Asset Manager Initiative and considers PAI indicators through stewardship including engagement, both are relevant to mitigate potential adverse impact as a company.

Due to the commitment to the Net Zero Asset Manager Initiative, the Management Company aims to reduce greenhouse gas emissions in partnership with asset owner clients on decarbonisation goals, consistent with an ambition to reach net zero emission by 2050 or sooner across all assets under management. As part of this objective the Management Company will set an interim target for the proportion of assets to be managed in line with the attainment of net zero emissions by 2050 or sooner.

The Sub-Fund's Investment Manager considers PAI indicators regarding greenhouse gas emission, biodiversity, water, waste as well as social and employee matters for corporate issuers, and, where relevant, the freedom house index is applied to investments in sovereigns. PAI indicators are considered within the Investment Manager's investment process through the means of exclusions as described in the "binding elements" section of the Sub-Fund.

The data coverage for the data required for the PAI indicators is heterogenous. The data coverage related to biodiversity, water and waste is low and the related PAI indicators are considered through exclusion of securities issued by companies having a severe violation / breach of principles and guidelines such as the Principles of the United Nations Global Compact, the OECD Guidelines for Multinational Enterprises, and the United Nations Guiding Principles for Business and Human Rights on the grounds of problematic practices around human rights, labour rights, environment, and corruption issues. Therefore, the Investment Manager will strive to increase data coverage for PAI indicators with low data coverage. The Investment Manager will regularly evaluate whether the availability of data has increased sufficiently to potentially include assessment of such data in the investment process.

Additionally, PAI indicators are, among other sustainability factors, applied to derive the SRI Rating. The SRI Rating is used for the portfolio construction.

The following PAI indicators are considered:

Applicable to corporate issuers

- GHG Emissions
- Carbon footprint
- GHG Intensity of investee companies
- Exposure to companies active in the fossil fuel sector
- Activities negatively affecting biodiversity-sensitive areas
- Emissions to water
- Hazardous waste ratio

- Violation of UN Global compact principles
- Lack of processes and compliance mechanisms to monitor compliance with UN Global Compact principles
- Board gender diversity
- Exposure to controversial weapons

Applicable to sovereign and supranational issuers

- Investee countries subject to social violations

The information on the PAI indicators will be available in the end-year report of the Sub-Fund.



What investment strategy does this financial product follow?

The investment strategy guides investment decisions based on factors such as investment objectives and risk tolerance.

Allianz Global Sustainability's investment objective is to invest in global equity markets of developed countries in accordance with the Sustainable and Responsible Investment Strategy (SRI Strategy). The Investment Manager may engage in foreign currency overlay and thus assume separate foreign currency risks with regard to currencies of OECD member states, even if the Sub-Fund does not include any assets denominated in these respective currencies.

As part of the SRI best-in-class approach, the Sub-Fund takes environmental, social, human rights, governance, and business behaviour factors into account as follows:

- The aforesaid sustainability factors are analysed through SRI Research by the Investment Manager in order to assess how sustainable development and long-term issues are taken into account in the strategy of an issuer. SRI Research means the overall process of identifying potential risks as well as potential opportunities of an investment in securities of an issuer related to the analysis of sustainability factors. SRI Research data combines external research data (which might have some limitations) with internal analyses.
- Based on a combination of the results of the external and/or internal analyses of the sustainability factors, an internal rating is derived monthly (SRI Rating) and is afterwards assigned to a corporate or sovereign issuer.

This internal SRI Rating is used to rank and select or weight securities for the portfolio construction.

The Sub-Fund's general investment approach (Sub-Fund's applicable General Asset Class Principles in combination with its individual investment restrictions) is described in the prospectus.

● What are the binding elements of the investment strategy used to select the investments to attain each of the environmental or social characteristics promoted by this financial product?

The binding elements are:

- Minimum rating coverage: At least 90% Sub-Fund's portfolio is required to have an SRI Rating (Portfolio in this respect does not comprise non-rated derivatives and instruments that are non-rated by nature (e.g., cash and deposits). While most holdings of the Sub-Fund's will have a corresponding SRI Rating some investments cannot be rated according to the SRI Research methodology. Examples of instruments not attaining to the SRI Rating include, but are not limited to cash, deposits, Target Funds, and non-rated investments.
- 75% of the rated instruments are adhering to the minimum rating threshold of 2 (out of a rating scale from 0 – 4; 0 being the worst rating and 4 the best rating), and 25% are adhering to a rating threshold between 1.25 and 2.
- Reduction of investment universe by excluding at least 20% of issuers.
- Application of the below sustainable minimum exclusion criteria and Sub-Fund specific exclusion criteria.

The following sustainable minimum exclusion criteria for direct investments apply:

- securities issued by companies having a severe violation / breach of principles and guidelines such as the Principles of the United Nations Global Compact, the OECD Guidelines for Multinational Enterprises, and the United Nations Guiding Principles for Business and Human Rights on the grounds of problematic practices around human rights, labour rights, environment, and corruption issues,
- securities issued by companies involved in controversial weapons (anti-personnel mines, cluster munitions, chemical weapons, biological weapons, depleted uranium, white phosphorus, and nuclear weapons),

- securities issued by companies that derive more than 10% of their revenues from weapons, military equipment, and services,
- securities issued by companies that derive more than 10% of their revenue from thermal coal extraction,
- securities issued by utility companies that generate more than 20% of their revenues from coal,
- securities issued by companies involved in the production of tobacco, and securities issued by companies involved in the distribution of tobacco with more than 5% of their revenues.

The following Sub-Fund specific exclusion criteria for direct investments apply:

Sub-Fund assets may not be invested in Equities that generate a share of more than 5% of its revenues in the sectors (i) alcohol, (ii) armament, (iii) gambling, and (iv) pornography.

Direct investments in sovereign issuers with an insufficient freedom house index score are excluded.

The sustainable minimum exclusion criteria, as well as the Sub-Fund specific exclusion criteria, are based on information from an external data provider and coded in pre- and post-trade compliance. The review is performed at least half yearly.

● **What is the committed minimum rate to reduce the scope of the investments considered prior to the application of that investment strategy?**

The Sub-Fund commits to reduce the investment universe by at least 20%.

● **What is the policy to assess good governance practices of the investee companies?**

Good governance principles are considered by screening out companies based on their involvement in controversies around international norms corresponding to the four good governance practices: sound management structures, employee relations, remuneration of staff and tax compliance. Companies having a severe violation in either of those areas will not be investible. For certain cases, flagged issuers shall be on a watch list. These companies will appear on this watch list when the Investment Manager believes that engagement may lead to improvements or when the company is assessed to take remedial actions. Companies on the watch list remain investible unless the Investment Manager believes that the engagement or the remedial actions of the company does not lead to the desired remedy of the severe controversy.

In addition, the Sub-Fund's Investment Manager is committed to actively encourage open dialogues with investee companies on corporate governance, proxy voting and broader sustainability issues in advance of shareholder meetings (regularly for direct investments in shares). The Sub-Fund's Investment Manager's approach to proxy voting and company engagement is set out in the Management Company's Stewardship Statement.

Good governance practices include sound management structures, employee relations, remuneration of staff and tax compliance.



What is the asset allocation planned for this financial product?

Asset allocation describes the share of investments in specific assets.

Min. 90% of the Sub-Funds' assets (excluding cash and non-rated derivatives) are used to meet the environmental or social characteristics promoted by this Sub-Fund. A low portion of the Sub-Fund might contain assets which do not promote environmental or social characteristics. Examples of such instruments are derivatives, cash and deposits, some Target Funds and investment with temporarily divergent or absent environmental, social, or good governance qualifications. Min. 20% of the Sub-Funds' assets will be invested in Sustainable Investments. The minimum percentage of investments that are aligned with the EU Taxonomy is 0.01%. The Sub-Fund's Investment Manager does not commit to a minimum share of environmentally Sustainable Investments that are not aligned with the EU Taxonomy. The Sub-Fund's Investment Manager does not commit to a minimum share of socially sustainable investments. While the Sub-Fund cannot commit to a minimum share of environmentally or socially sustainable investments, such investments may be freely allocated to within the Sub-Fund aggregated sustainable investment commitment disclosed (min. 20%).

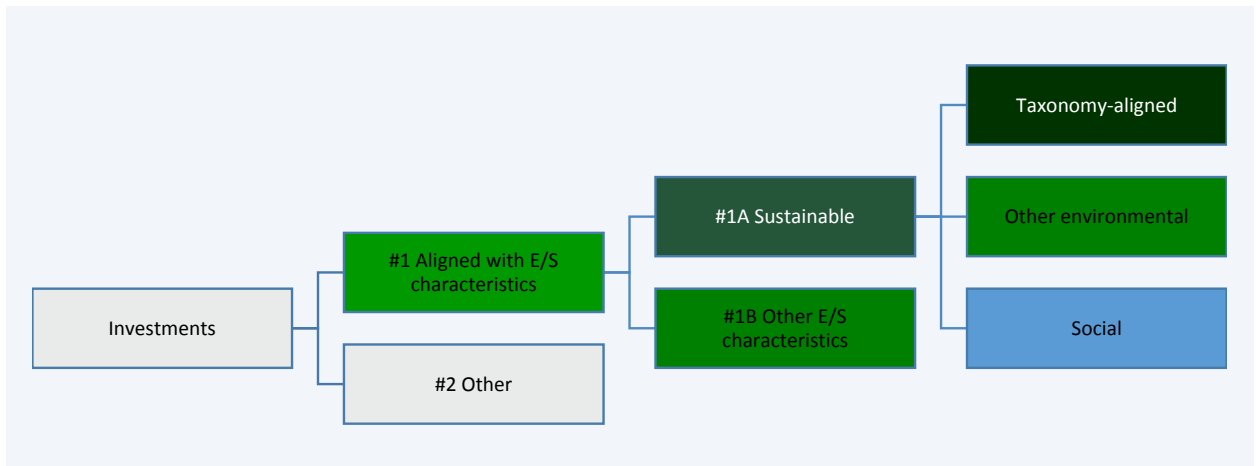

#1 Aligned with E/S characteristics includes the investments of the financial product used to attain the environmental or social characteristics promoted by the financial product.

#2 Other includes the remaining investments of the financial product which are neither aligned with the environmental or social characteristics, nor are qualified as sustainable investments.

The category **#1 Aligned with E/S characteristics** covers:

- The sub-category **#1A Sustainable** covers sustainable investments with environmental or social objectives.
- The sub-category **#1B Other E/S characteristics** covers investments aligned with the environmental or social characteristics that do not qualify as sustainable investments.

- **How does the use of derivatives attain the environmental or social characteristics promoted by the financial product?**

Not applicable



To what minimum extent are sustainable investments with an environmental objective aligned with the EU Taxonomy?

The Taxonomy-aligned investments include debt and/or equity in environmentally sustainable economic activities aligned with the EU-Taxonomy. The minimum percentage of investments that are aligned with the EU Taxonomy is 0.01%. Taxonomy-aligned data is provided by an external data provider. The Investment Manager has assessed the quality of such data. The data will not be subject to an assurance provided by auditors or a review by third parties. The data will not reflect any data in government bonds. As of today, there is no recognized methodology available to determine the proportion of Taxonomy-aligned activities when investing in government bonds.

Taxonomy-aligned activities in this disclosure are based on share of turnover. Pre-contractual figures use turnover as its financial metric as a default in line with the regulatory requirements and based on the fact that complete, verifiable or up-to date data for CAPEX and/or OPEX as financial metric is even less available.

Taxonomy-aligned data is only in rare cases data reported by companies in accordance with the EU Taxonomy. The data provider has derived Taxonomy-aligned data from other available equivalent public data.

- **Does the financial product invest in fossil gas and/or nuclear energy related activities that comply with the EU Taxonomy ¹?**

Yes:

In fossil gas In nuclear energy

No

The Sub-Fund does not pursue any investments in fossil gas and/or nuclear energy related activities that comply with the EU Taxonomy. Nevertheless, as result of this investment strategy, investments may occur in corporates which are also active in these activities. Further information will be provided as part of the annual reporting, if relevant.

Taxonomy-aligned activities are expressed as a share of:

- **turnover** reflecting the share of revenue from green activities of investee companies
- **capital expenditure (CapEx)** showing the green investments made by investee companies, e.g. for a transition to a green

¹ Fossil gas and/or nuclear related activities will only comply with the EU Taxonomy where they contribute to limiting climate change ("climate change mitigation") and do not significantly harm any EU Taxonomy objective - see explanatory note in the left hand margin. The full criteria for fossil gas and nuclear energy economic activities that comply with the EU Taxonomy are laid down in Commission Delegated Regulation (EU) 2022/1214.

economy.
 - **operational expenditure (OpEx)** reflecting green operational activities of investee companies.

The two graphs below show in green the minimum percentage of investments that are aligned with the EU Taxonomy. As there is no appropriate methodology to determine the Taxonomy-alignment of sovereign bonds*, the first graph shows the Taxonomy-alignment in relation to all the investments of the financial product including sovereign bonds, while the second graph shows the Taxonomy-alignment only in relation to the investments of the financial product other than sovereign bonds.

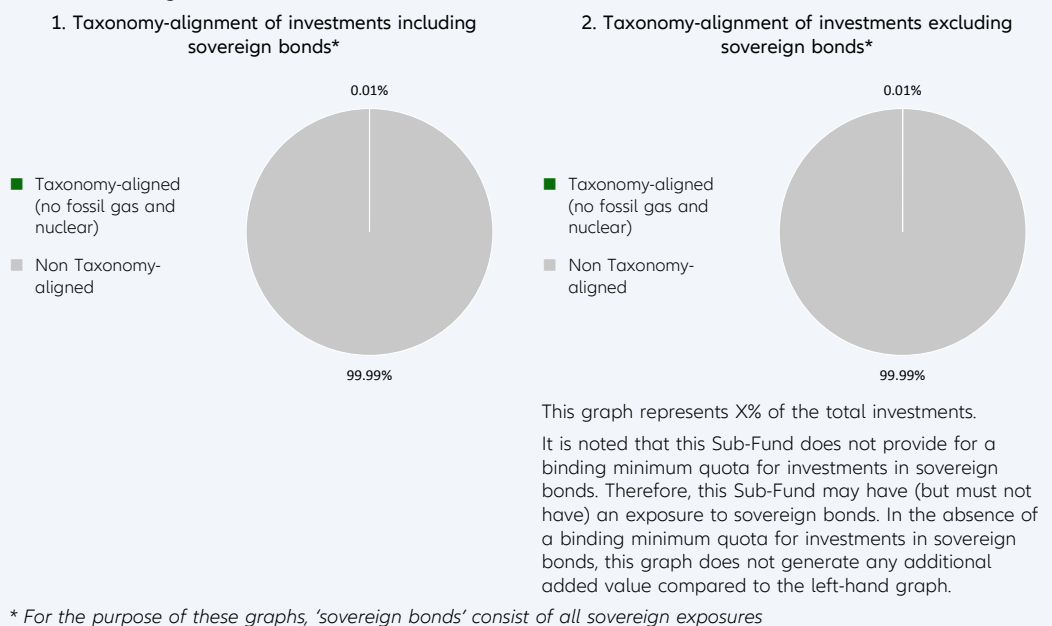

Enabling activities directly enable other activities to make a substantial contribution to an environmental objective.

● **What is the minimum share of investments in transitional and enabling activities?**

The Sub-Fund's Investment Manager does not commit to a split of minimum taxonomy alignment into transitional, enabling activities and own performance.

Transitional activities are activities for which low-carbon alternatives are not yet available and among others have greenhouse gas emission levels corresponding to the best performance.



What is the minimum share of sustainable investments with an environmental objective that are not aligned with the EU Taxonomy?

Taxonomy-aligned investments are considered a sub-category of Sustainable Investments. If an investment is not Taxonomy-aligned since the activity is not yet covered under the EU Taxonomy or the positive contribution is not substantial enough to comply with the Taxonomy technical screening criteria, the investment can still be considered an environmentally Sustainable Investment provided it complies with all criteria. The Investment Manager does not commit to a minimum share of environmentally Sustainable Investments that are not aligned with the EU Taxonomy. The overall sustainable investment share may also include investments with an environmental objective in economic activities that do not qualify as environmentally sustainable under the EU Taxonomy, and while the Sub-Fund cannot commit to a minimum share of environmentally or socially sustainable investments, such investments may be freely allocated to within the Sub-Fund aggregated sustainable investment commitment disclosed (min. 20%).

are sustainable investments with an environmental objective that **do not take into account the criteria** for environmentally sustainable economic activities under the EU Taxonomy.



What is the minimum share of socially sustainable investments?

The Investment Manager defines Sustainable Investments based on internal research, which uses, among others, the UN Sustainable Development Goals (SDGs), as well as the objectives of the EU Taxonomy as reference frameworks. The Investment Manager does not commit to a minimum share of socially Sustainable Investments, as the SDGs contain environmental as well as social objectives. The overall sustainable investment share may also include investments with a social objective, and while the Sub-Fund cannot commit to a minimum share of environmentally or socially sustainable investments, such investments may be freely allocated to within the Sub-Fund aggregated sustainable investment commitment disclosed (min. 20%).



What investments are included under “#2 Other”, what is their purpose and are there any minimum environmental or social safeguards?

Under “#2 Other” investments into cash, Target Funds, or derivatives can be included. Derivatives might be used for efficient portfolio management (including risk hedging) and/or investment purposes, and Target Funds to benefit from a specific strategy. For those investments no environmental or social safeguards are applied.



Is a specific index designated as a reference benchmark to determine whether this financial product is aligned with the environmental and/or social characteristics that it promotes?

Yes, the Sub-Fund has assigned the DOW JONES Sustainability World Index (Total Return) as benchmark

- **How is the reference benchmark continuously aligned with each of the environmental or social characteristics promoted by the financial product?**

The Sub-Fund uses a sustainable benchmark which is however not completely aligned with the environmental or social characteristics promoted by the sub-fund. The benchmark uses a best-in-class approach based on ESG criteria. The specific screening and exclusion criteria deviate from the Sub-Fund's investment strategy.

- **How is the alignment of the investment strategy with the methodology of the index ensured on a continuous basis?**

The benchmark is not continuously aligned as the screening and exclusion criteria of the benchmark deviate from the Sub-Fund's investment strategy.

- **How does the designated index differ from a relevant broad market index?**

The benchmark uses a best-in-class approach based on ESG criteria for index construction.

- **Where can the methodology used for the calculation of the designated index be found?**

Details of the benchmark's methodology may be found at <https://www.spglobal.com/spdji/en/documents/methodologies/methodology-dj-sustainability-indices.pdf> or at www.spglobal.com



Where can I find more product specific information online?

More product-specific information can be found on the website: <https://regulatory.allianzgi.com/SFDR>

Reference benchmarks are indexes to measure whether the financial product attains the environmental or social characteristics that they promote.

Template pre-contractual disclosure for the financial products referred to in Article 8, paragraphs 1, 2 and 2a, of Regulation (EU) 2019/2088 and Article 6, first paragraph, of Regulation (EU) 2020/852

Product name:

Allianz Global Water

Legal entity identifier: 529900NQRL4PJUZL0R84

Environmental and/or social characteristics

Sustainable investment means an investment in an economic activity that contributes to an environmental or social objective, provided that the investment does not significantly harm any environmental or social objective and that the investee companies follow good governance practices.

The EU Taxonomy is a classification system laid down in Regulation (EU) 2020/852, establishing a list of environmentally sustainable economic activities. That Regulation does not include a list of socially sustainable economic activities. Sustainable investments with an environmental objective might be aligned with the Taxonomy or not.

Does this financial product have a sustainable investment objective?	
<input checked="" type="radio"/> <input checked="" type="radio"/> Yes	<input checked="" type="radio"/> <input type="radio"/> No
<input type="checkbox"/> It will make a minimum of sustainable investments with an environmental objective: ___% <ul style="list-style-type: none"> <input type="checkbox"/> in economic activities that qualify as environmentally sustainable under the EU Taxonomy <input type="checkbox"/> in economic activities that do not qualify as environmentally sustainable under the EU Taxonomy <input type="checkbox"/> It will make a minimum of sustainable investments with a social objective ___%	<input checked="" type="checkbox"/> It promotes Environmental/Social (E/S) characteristics and while it does not have as its objective a sustainable investment, it will have a minimum proportion of 50.00% of sustainable investments <ul style="list-style-type: none"> <input checked="" type="checkbox"/> with an environmental objective in economic activities that qualify as environmentally sustainable under the EU Taxonomy <input checked="" type="checkbox"/> with an environmental objective in economic activities that do not qualify as environmentally sustainable under the EU Taxonomy <input checked="" type="checkbox"/> with a social objective <input type="checkbox"/> It promotes E/S characteristics, but will not make any sustainable investments



What environmental and/or social characteristics are promoted by this financial product?

Allianz Global Water's (the "Sub-Fund") invests in securities of companies providing products or services which contribute to environmental or social objectives, as defined by the UN Sustainable Development Goals (SDGs) or the EU Taxonomy objectives, which are also related to the SDGs. The contribution is measured according to the Sustainable Investment methodology.

In addition, sustainable minimum exclusion criteria apply.

No reference benchmark has been designated for the purpose of attaining the environmental and/or social characteristics promoted by the Sub-Fund.

● What sustainability indicators are used to measure the attainment of each of the environmental or social characteristics promoted by this financial product?

To measure the attainment of the Sub-Fund's sustainable investment objective the following sustainability indicators are used and reported on, at the fiscal year end:

- The actual Sustainable Investment share – which is based on SDGs or EU Taxonomy objectives
- Principle Adverse Impacts (PAIs) of investment decisions on sustainability factors are considered through the application of exclusion criteria.

Sustainability indicators measure how the environmental or social characteristics promoted by the financial product are attained.

- **What are the objectives of the sustainable investments that the financial product partially intends to make and how does the sustainable investment contribute to such objectives?**

Sustainable investments contribute to environmental and/or social objectives, for which the Investment Manager uses as reference frameworks, among others, the UN Sustainable Development Goals (SDGs), as well as the objectives of the EU Taxonomy:

1. Climate Change Mitigation
2. Climate Change Adaptation
3. Sustainable Use and Protection of Water and Marine Resources
4. Transition to a Circular Economy
5. Pollution Prevention and Control
6. Protection and Restoration of Biodiversity and Ecosystems

The assessment of the positive contribution to the environmental or social objectives is based on a proprietary framework which combines quantitative elements with qualitative inputs from internal research. The methodology applies first a quantitative breakdown of a securities issuer into its business activities. The qualitative element of the framework is an assessment if business activities contribute positively to an environmental or a social objective.

To calculate the positive contribution on the Sub-Fund level the revenue share of each issuer attributable to business activities contributing to environmental and/or social objectives is considered provided the issuer is satisfying the Do No Significant Harm (“DNSH”) and Good Governance principles, and an asset-weighted aggregation is performed as a second step. Moreover, for certain types of securities, which finance specific projects contributing to environmental or social objectives the overall investment is considered to contribute to environmental and/or social objectives, but also for these a DNSH as well as a Good Governance check for issuers is performed.

- **How do the sustainable investments that the financial product partially intends to make, not cause significant harm to any environmental or social sustainable investment objective?**

In order to ensure that Sustainable Investments do not significantly harm any other environmental and/or social objective, the Investment Manager is leveraging the PAI indicators, whereby significance thresholds have been defined to identify significantly harmful issuers. Issuers not meeting the significance threshold can be engaged for a limited time period to remediate the adverse impact. Otherwise, if the issuer does not meet the defined significance thresholds twice subsequently or in case of a failed engagement, it does not pass the DNSH assessment. Investments in securities of issuers which do not pass the DNSH assessment are not counted as sustainable investments.

- *How have the indicators for adverse impacts on sustainability factors been taken into account?*

All mandatory PAI indicators are considered either as part of the application of the exclusion criteria or through thresholds on a sectorial or absolute basis. Significance thresholds have been defined and they refer to qualitative or quantitative criteria.

Recognizing the lack of data coverage for some of the PAI indicators equivalent data points are used to assess PAI indicators when applying the DNSH assessment, when relevant, for the following indicators for corporates: share of non-renewable energy consumption and production, activities negatively affecting biodiversity-sensitive areas, emissions to water, lack of processes and compliance mechanisms to monitor compliance with UNGC principles and OECD Guidelines for Multinational Enterprises; for sovereigns: GHG Intensity and investee countries subject to social violations. In case of securities which finance specific projects contributing to environmental or social objectives equivalent data at project level might be used to ensure that Sustainable Investments do not significantly harm any other environmental and/or social objective. The Investment Manager will strive to increase data coverage for PAI indicators with low data coverage by engaging with issuers and data providers. The Investment Manager will regularly evaluate whether the availability of data has increased sufficiently to potentially include assessment of such data in the investment process.

- *How are the sustainable investments aligned with the OECD Guidelines for Multinational Enterprises and the UN Guiding Principles on Business and Human Rights? Details:*

The Investment Manager’s sustainable minimum exclusion list screens out companies based on their involvement in controversial practices against international norms. The core normative framework consists of the Principles of the UN Global Compact, the OECD Guidelines for Multinational Enterprises

Principal adverse impacts are the most significant negative impacts of investment decisions on sustainability factors relating to environmental, social and employee matters, respect for human rights, anti-corruption and anti-bribery matters.

and the UN Guiding Principles for Business and Human Rights. Securities issued by companies having a severe violation of these frameworks will be restricted from the investment universe.

The EU Taxonomy sets out a “do not significant harm” principle by which Taxonomy-aligned investments should not significantly harm EU Taxonomy objectives and is accompanied by specific EU criteria.

The “do not significant harm” principle applies only to those investments underlying the financial product that take into account the EU criteria for environmentally sustainable economic activities. The investments underlying the remaining portion of this financial product do not take into account the EU criteria for environmentally sustainable economic activities.

Any other sustainable investments must also not significantly harm any environmental or social objectives.



Does this financial product consider principal adverse impacts on sustainability factors?

Yes

No

The Management Company has joined the Net Zero Asset Manager Initiative and considers PAI indicators through stewardship including engagement, both are relevant to mitigate potential adverse impact as a company.

Due to the commitment to the Net Zero Asset Manager Initiative, the Management Company aims to reduce greenhouse gas emissions in partnership with asset owner clients on decarbonisation goals, consistent with an ambition to reach net zero emission by 2050 or sooner across all assets under management. As part of this objective the Management Company will set an interim target for the proportion of assets to be managed in line with the attainment of net zero emissions by 2050 or sooner.

The Sub-Fund’s Investment Manager considers PAI indicators regarding greenhouse gas emission, biodiversity, water, waste as well as social and employee matters for corporate issuers, and, where relevant, the freedom house index is applied to investments in sovereigns. PAI indicators are considered within the Investment Manager’s investment process through the means of exclusions as described in the “binding elements” section of the Sub-Fund.

The data coverage for the data required for the PAI indicators is heterogenous. The data coverage related to biodiversity, water and waste is low and the related PAI indicators are considered through exclusion of securities issued by companies having a severe violation / breach of principles and guidelines such as the Principles of the United Nations Global Compact, the OECD Guidelines for Multinational Enterprises, and the United Nations Guiding Principles for Business and Human Rights on the grounds of problematic practices around human rights, labour rights, environment, and corruption issues. Therefore, the Investment Manager will strive to increase data coverage for PAI indicators with low data coverage. The Investment Manager will regularly evaluate whether the availability of data has increased sufficiently to potentially include assessment of such data in the investment process.

Additionally, PAI indicators are considered as part of the requirement of the Sub-Fund to invest 50% into Sustainable Investments. PAI indicators are used as part of the DNSH assessment. Investments in securities of issuers who do not pass the DNSH assessment are not counted as sustainable investments.

The following PAI indicators are considered:

Applicable to corporate issuers

- GHG Emissions
- Carbon footprint
- GHG Intensity of investee companies
- Exposure to companies active in the fossil fuel sector
- Share of non-renewable energy consumption and production
- Energy consumption intensity per high impact climate sector
- Activities negatively affecting biodiversity-sensitive areas
- Emissions to water
- Hazardous waste ratio
- Violation of UN Global compact principles

- Lack of processes and compliance mechanisms to monitor compliance with UN Global Compact principles
- Unadjusted gender pay gap
- Board gender diversity
- Exposure to controversial weapons

Applicable to sovereign and supranational issuers

- GHG Intensity
- Investee countries subject to social violations

The information on the PAI indicators will be available in the end-year report of the Sub-Fund.



What investment strategy does this financial product follow?

The investment strategy guides investment decisions based on factors such as investment objectives and risk tolerance.

Allianz Global Water's investment objective is to invest in global Equity Markets with a focus on companies with an engagement in the area of water resource management in accordance with the SDG-Aligned Strategy.

The Sub-Fund invests in Equities of companies which offer products and services across themes of water resource management. Companies which engage in the area of water resource management are companies which offer products or services that create positive environmental and social outcomes along water scarcity and quality issues and helps to improve the sustainability of global water resources, as targeted by the SDGs No. 2, 3, 6, 11 and 13.

The Sub-Fund's general investment approach (Sub-Fund's applicable General Asset Class Principles in combination with its individual investment restrictions) is described in the prospectus.

● What are the binding elements of the investment strategy used to select the investments to attain each of the environmental or social characteristics promoted by this financial product?

The binding elements are:

- Minimum 50% of the Sub-Fund assets' weighted average shall result from revenue generated from issuers' activities that facilitate the achievement of one or more SDG or EU Taxonomy objectives as measured according to the Sustainable Investment methodology.
- For at least 80% of the Sub-Fund portfolio, the respective issuer shall have a minimum share of 20% Sustainable Investments. Cash and derivatives are excluded from the aforesaid thresholds.
- Application of the following sustainable minimum exclusion criteria for direct investments:
 - securities issued by companies having a severe violation / breach of principles and guidelines such as the Principles of the United Nations Global Compact, the OECD Guidelines for Multinational Enterprises, and the United Nations Guiding Principles for Business and Human Rights on the grounds of problematic practices around human rights, labour rights, environment, and corruption issues,
 - securities issued by companies involved in controversial weapons (anti-personnel mines, cluster munitions, chemical weapons, biological weapons, depleted uranium, white phosphorus, and nuclear weapons),
 - securities issued by companies that derive more than 10% of their revenues from weapons, military equipment, and services,
 - securities issued by companies that derive more than 10% of their revenue from thermal coal extraction,
 - securities issued by utility companies that generate more than 20% of their revenues from coal,
 - securities issued by companies involved in the production of tobacco, and securities issued by companies involved in the distribution of tobacco with more than 5% of their revenues.

Direct investments in sovereign issuers with an insufficient freedom house index score are excluded.

The sustainable minimum exclusion criteria are based on information from an external data provider and coded in pre- and post-trade compliance. The review is performed at least half yearly.

- **What is the committed minimum rate to reduce the scope of the investments considered prior to the application of that investment strategy?**

The Sub-Fund does not commit to reduce the scope of the investments by a certain minimum rate.

- **What is the policy to assess good governance practices of the investee companies?**

Good governance principles are considered by screening out companies based on their involvement in controversies around international norms corresponding to the four good governance practices: sound management structures, employee relations, remuneration of staff and tax compliance. Companies having a severe violation in either of those areas will not be investible. For certain cases, flagged issuers shall be on a watch list. These companies will appear on this watch list when the Investment Manager believes that engagement may lead to improvements or when the company is assessed to take remedial actions. Companies on the watch list remain investible unless the Investment Manager believes that the engagement or the remedial actions of the company does not lead to the desired remedy of the severe controversy.

In addition, the Sub-Fund’s Investment Manager is committed to actively encourage open dialogues with investee companies on corporate governance, proxy voting and broader sustainability issues in advance of shareholder meetings (regularly for direct investments in shares). The Sub-Fund’s Investment Manager’s approach to proxy voting and company engagement is set out in the Management Company’s Stewardship Statement.

Good governance practices include sound management structures, employee relations, remuneration of staff and tax compliance.



What is the asset allocation planned for this financial product?

Asset allocation describes the share of investments in specific assets.

Min. 80% of the Sub-Funds’ assets (excluding cash, and derivatives) are used to meet the environmental or social characteristics promoted by this Sub-Fund. A low portion of the Sub-Fund might contain assets which do not promote environmental or social characteristics. Example of such instruments are derivatives, cash and deposits, some Target Funds and investment with temporarily divergent or absent environmental, social, or good governance qualifications. The Sub-Fund invest primarily into securities which offer products and services to facilitate the achievements of the SDGs. Min. 50% of the Sub-Funds' assets will be invested in Sustainable Investments. The Sub-Fund’s Investment Manager does not commit to a minimum share of sustainable investments with an environmental objective aligned with the EU Taxonomy nor to a minimum share of environmentally Sustainable Investments that are not aligned with the EU Taxonomy. The Sub-Fund’s Investment Manager does not commit to a minimum share of socially sustainable investments. While the Sub-Fund cannot commit to a minimum share of environmentally or socially sustainable investments, such investments may be freely allocated to within the Sub-Fund aggregated sustainable investment commitment disclosed (min. 50%).

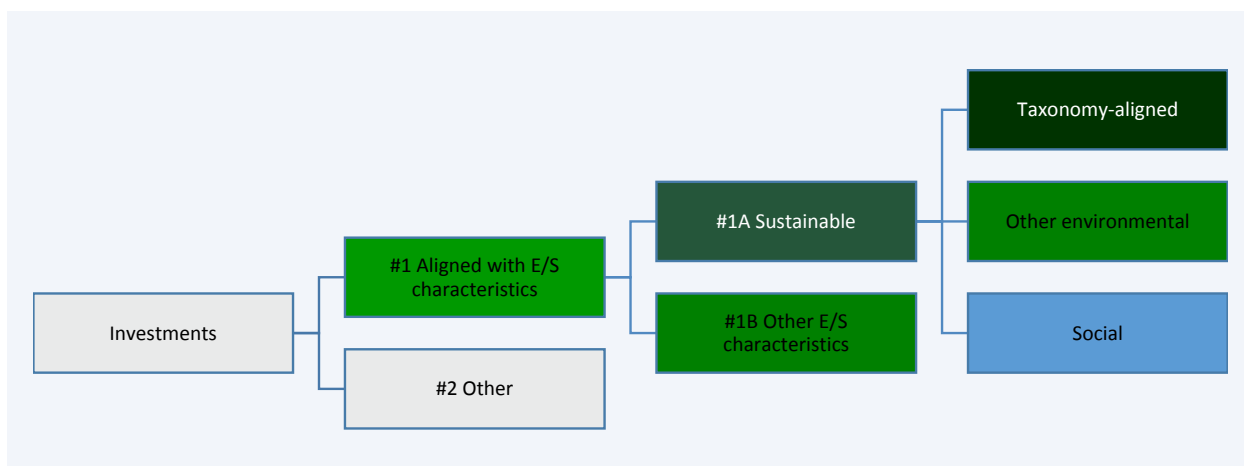

#1 Aligned with E/S characteristics includes the investments of the financial product used to attain the environmental or social characteristics promoted by the financial product.

#2 Other includes the remaining investments of the financial product which are neither aligned with the environmental or social characteristics, nor are qualified as sustainable investments.

The category **#1 Aligned with E/S characteristics** covers:

- The sub-category **#1A Sustainable** covers sustainable investments with environmental or social objectives.
- The sub-category **#1B Other E/S characteristics** covers investments aligned with the environmental or social characteristics that do not qualify as sustainable investments.

- How does the use of derivatives attain the environmental or social characteristics promoted by the financial product?

Not applicable



To what minimum extent are sustainable investments with an environmental objective aligned with the EU Taxonomy?

The Sub-Fund’s Investment Manager does not commit to a minimum share of sustainable investments with an environmental objective aligned with the EU Taxonomy. The overall sustainable investment share may also include investments with an environmental objective in economic activities that qualify as environmentally sustainable under the EU Taxonomy.

- Does the financial product invest in fossil gas and/or nuclear energy related activities that comply with the EU Taxonomy ¹?

Yes:
 In fossil gas In nuclear energy
 No

The Sub-Fund does not pursue any investments in fossil gas and/or nuclear energy related activities that comply with the EU Taxonomy. Nevertheless, as result of this investment strategy, investments may occur in corporates which are also active in these activities. Further information will be provided as part of the annual reporting, if relevant.

The two graphs below show in green the minimum percentage of investments that are aligned with the EU Taxonomy. As there is no appropriate methodology to determine the Taxonomy-alignment of sovereign bonds*, the first graph shows the Taxonomy-alignment in relation to all the investments of the financial product including sovereign bonds, while the second graph shows the Taxonomy-alignment only in relation to the investments of the financial product other than sovereign bonds.

1. Taxonomy-alignment of investments including sovereign bonds*

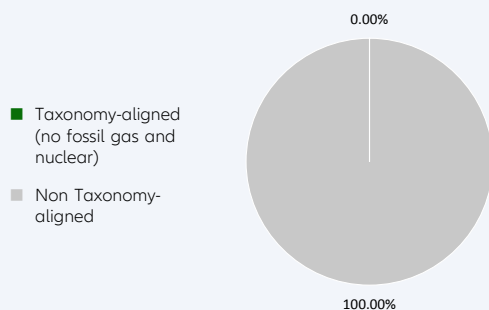

2. Taxonomy-alignment of investments excluding sovereign bonds*

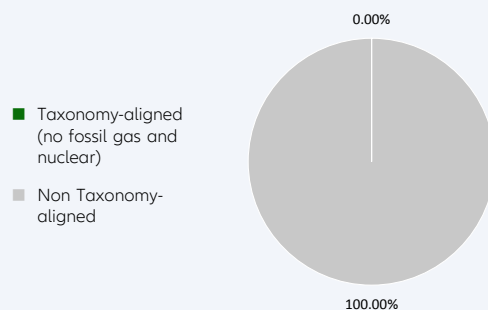

This graph represents X% of the total investments. It is noted that – due to the fact that this Sub-Fund does not provide for a minimum quota of taxonomy-aligned investments – this graph does not generate any additional added value compared to the left-hand graph.

* For the purpose of these graphs, ‘sovereign bonds’ consist of all sovereign exposures

- What is the minimum share of investments in transitional and enabling activities?

The Sub-Fund’s Investment Manager does not commit to a split of minimum taxonomy alignment into transitional, enabling activities and own performance.

Taxonomy-aligned activities are expressed as a share of:
 - **turnover** reflecting the share of revenue from green activities of investee companies
 - **capital expenditure** (CapEx) showing the green investments made by investee companies, e.g. for a transition to a green economy.
 - **operational expenditure** (OpEx) reflecting green operational activities of investee companies.

Enabling activities directly enable other activities to make a substantial contribution to an environmental objective.

Transitional activities are activities for which low-carbon alternatives are not yet available

¹ Fossil gas and/or nuclear related activities will only comply with the EU Taxonomy where they contribute to limiting climate change (“climate change mitigation”) and do not significantly harm any EU Taxonomy objective - see explanatory note in the left hand margin. The full criteria for fossil gas and nuclear energy economic activities that comply with the EU Taxonomy are laid down in Commission Delegated Regulation (EU) 2022/1214.

and among others have greenhouse gas emission levels corresponding to the best performance.



What is the minimum share of sustainable investments with an environmental objective that are not aligned with the EU Taxonomy?

Taxonomy-aligned investments are considered a sub-category of Sustainable Investments. If an investment is not Taxonomy-aligned since the activity is not yet covered under the EU Taxonomy or the positive contribution is not substantial enough to comply with the Taxonomy technical screening criteria, the investment can still be considered an environmentally Sustainable Investment provided it complies with all criteria. The Investment Manager does not commit to a minimum share of environmentally Sustainable Investments that are not aligned with the EU Taxonomy. The overall sustainable investment share may also include investments with an environmental objective in economic activities that do not qualify as environmentally sustainable under the EU Taxonomy, and while the Sub-Fund cannot commit to a minimum share of environmentally or socially sustainable investments, such investments may be freely allocated to within the Sub-Fund aggregated sustainable investment commitment disclosed (min. 50%).



are sustainable investments with an environmental objective that **do not take into account the criteria** for environmentally sustainable economic activities under the EU Taxonomy.



What is the minimum share of socially sustainable investments?

The Investment Manager defines Sustainable Investments based on internal research, which uses, among others, the UN Sustainable Development Goals (SDGs), as well as the objectives of the EU Taxonomy as reference frameworks. The Investment Manager does not commit to a minimum share of socially Sustainable Investments, as the SDGs contain environmental as well as social objectives. The overall sustainable investment share may also include investments with a social objective, and while the Sub-Fund cannot commit to a minimum share of environmentally or socially sustainable investments, such investments may be freely allocated to within the Sub-Fund aggregated sustainable investment commitment disclosed (min. 50%).



What investments are included under “#2 Other”, what is their purpose and are there any minimum environmental or social safeguards?

Under “#2 Other” investments into cash, Target Funds, or derivatives can be included. Derivatives might be used for efficient portfolio management (including risk hedging) and/or investment purposes, and Target Funds to benefit from a specific strategy. For those investments no environmental or social safeguards are applied.



Is a specific index designated as a reference benchmark to determine whether this financial product is aligned with the environmental and/or social characteristics that it promotes?

No reference benchmark has been designated for the purpose of attaining the environmental and/or social characteristics promoted by the Sub-Fund.

Reference benchmarks are indexes to measure whether the financial product attains the environmental or social characteristics that they promote.

- How is the reference benchmark continuously aligned with each of the environmental or social characteristics promoted by the financial product?

Not applicable

- How is the alignment of the investment strategy with the methodology of the index ensured on a continuous basis?

Not applicable

- How does the designated index differ from a relevant broad market index?
Not applicable
- Where can the methodology used for the calculation of the designated index be found?
Not applicable



Where can I find more product specific information online?

More product-specific information can be found on the website: <https://regulatory.allianzgi.com/SFDR>

Template pre-contractual disclosure for the financial products referred to in Article 9, paragraphs 1 to 4a, of Regulation (EU) 2019/2088 and Article 5, first paragraph, of Regulation (EU) 2020/852

Product name:

Allianz Green Bond

Legal entity identifier: 549300JPE1XADGY8YM71

Sustainable investment objective

Sustainable investment means an investment in an economic activity that contributes to an environmental or social objective, provided that the investment does not significantly harm any environmental or social objective and that the investee companies follow good governance practices.

The EU Taxonomy is a classification system laid down in Regulation (EU) 2020/852, establishing a list of **environmentally sustainable economic activities**. That Regulation does not include a list of socially sustainable economic activities. Sustainable investments with an environmental objective might be aligned with the Taxonomy or not.

Does this financial product have a sustainable investment objective?	
<input checked="" type="radio"/> <input checked="" type="radio"/> <input checked="" type="checkbox"/> Yes	<input type="radio"/> <input type="radio"/> <input type="checkbox"/> No
<input checked="" type="checkbox"/> It will make a minimum of sustainable investments with an environmental objective: 80.00%	<input type="checkbox"/> It promotes Environmental/Social (E/S) characteristics and while it does not have as its objective a sustainable investment, it will have a minimum proportion of ___% of sustainable investments
<input checked="" type="checkbox"/> in economic activities that qualify as environmentally sustainable under the EU Taxonomy	<input type="checkbox"/> with an environmental objective in economic activities that qualify as environmentally sustainable under the EU Taxonomy
<input checked="" type="checkbox"/> in economic activities that do not qualify as environmentally sustainable under the EU Taxonomy	<input type="checkbox"/> with an environmental objective in economic activities that do not qualify as environmentally sustainable under the EU Taxonomy
<input type="checkbox"/> It will make a minimum of sustainable investments with a social objective ___%	<input type="checkbox"/> with a social objective
<input type="checkbox"/>	<input type="checkbox"/> It promotes E/S characteristics, but will not make any sustainable investments



What is the sustainable investment objective of this financial product?

Allianz Green Bond (the “Sub-Fund”) follows the “Green Bond Strategy”. The Green Bond Strategy’s objective is to mobilize capital markets towards the transition to a low carbon society, natural capital preservation and adaptation to climate change. Green Bonds are designated Debt Securities intended to encourage sustainability and to support climate-related or other types of special environmental projects. The Sub-Fund invests primarily in Green Bonds financing climate change mitigation or adaptation projects or other environmental sustainability projects, notably in the following fields: energy efficiency, renewable energy, raw materials, water and land, waste management, greenhouse gas emissions reduction, biodiversity preservation or circular economy. The Sub-Funds will invest at least 80% of its assets in Sustainable investments.

In addition, Sub-Fund specific exclusion criteria apply.

A reference benchmark has been designated for the purpose of meeting the sustainable investment objective.

● **What sustainability indicators are used to measure the attainment of the sustainable investment objective of this financial product?**

To measure the attainment of the sustainable investment objective the following sustainability indicators are used and reported on, at the fiscal year end:

- The actual percentage of the Sub-Fund’s assets invested in Green Bonds.
- Confirmation that Principal Adverse Impacts (PAIs) of investment decisions on sustainability factors are considered through the application of exclusion criteria.

Sustainability indicators measure how the sustainable objectives of this financial product are attained.

- Actual sustainable investment share.
- Adherence to a minimum SRI Rating of 1 for Green Bonds held in the portfolio (out of a scale from 0-4; 0 being the worst rating and 4 the best rating).

● **How do sustainable investments not cause significant harm to any environmental or social sustainable investment objective?**

In order to ensure that Sustainable Investments do not significantly harm any other environmental and/or social objective, the Investment Manager is leveraging the PAI indicators, whereby significance thresholds have been defined to identify significantly harmful issuers. Issuers not meeting the significance threshold can be engaged for a limited time period to remediate the adverse impact. Otherwise, if the issuer does not meet the defined significance thresholds twice subsequently or in case of a failed engagement, it does not pass the DNSH assessment. Investments in securities of issuers which do not pass the DNSH assessment are not counted as sustainable investments.

● *How have the indicators for adverse impacts on sustainability factors been taken into account?*

All mandatory PAI indicators are considered either as part of the application of the exclusion criteria or through thresholds on a sectorial or absolute basis. Significance thresholds have been defined and they refer to qualitative or quantitative criteria.

Recognizing the lack of data coverage for some of the PAI indicators equivalent data points are used to assess PAI indicators when applying the DNSH assessment, when relevant, for the following indicators for corporates: share of non-renewable energy consumption and production, activities negatively affecting biodiversity-sensitive areas, emissions to water, lack of processes and compliance mechanisms to monitor compliance with UNGC principles and OECD Guidelines for Multinational Enterprises; for sovereigns: GHG Intensity and investee countries subject to social violations. In case of securities which finance specific projects contributing to environmental or social objectives equivalent data at project level might be used to ensure that Sustainable Investments do not significantly harm any other environmental and/or social objective. The Investment Manager will strive to increase data coverage for PAI indicators with low data coverage by engaging with issuers and data providers. The Investment Manager will regularly evaluate whether the availability of data has increased sufficiently to potentially include assessment of such data in the investment process.

● *How are the sustainable investments aligned with the OECD Guidelines for Multinational Enterprises and the UN Guiding Principles on Business and Human Rights? Details:*

The Investment Manager's Sub-Fund specific exclusion list screens out companies based on their involvement in controversial practices against international norms. The core normative framework consists of the Principles of the UN Global Compact, the OECD Guidelines for Multinational Enterprises and the UN Guiding Principles for Business and Human Rights. Securities issued by companies having a severe violation of these frameworks will be restricted from the investment universe.

Principal adverse impacts are the most significant negative impacts of investment decisions on sustainability factors relating to environmental, social and employee matters, respect for human rights, anti-corruption and anti-bribery matters.



Does this financial product consider principal adverse impacts on sustainability factors?

Yes

No

The Management Company has joined the Net Zero Asset Manager Initiative and considers PAI indicators through stewardship including engagement, both are relevant to mitigate potential adverse impact as a company.

Due to the commitment to the Net Zero Asset Manager Initiative, the Management Company aims to reduce greenhouse gas emissions in partnership with asset owner clients on decarbonisation goals, consistent with an ambition to reach net zero emission by 2050 or sooner across all assets under management. As part of this objective the Management Company will set an interim target for the proportion of assets to be managed in line with the attainment of net zero emissions by 2050 or sooner.

The Sub-Fund's Investment Manager addresses PAI indicators regarding greenhouse gas emission, biodiversity, water, waste as well as social and employee matters for corporate issuers, and, where relevant, the freedom house index is applied to investments in sovereigns. PAI indicators are considered within the Investment Manager's investment process through the means of exclusions as described in the "binding elements" section of the Sub-Fund.

The data coverage for the data required for the PAI indicators is heterogenous. Additionally, the data coverage related to biodiversity, water and waste is low and the related PAI indicators are considered through exclusion of securities issued by companies having a severe violation / breach of principles and guidelines such as the Principles of the United Nations Global Compact, the OECD Guidelines for Multinational Enterprises, and the United Nations Guiding Principles for Business and Human Rights on the grounds of problematic practices around human rights, labour rights, environment, and corruption issues. Therefore, the Investment Manager will strive to increase data coverage for PAI indicators with low data coverage. The Investment Manager will regularly evaluate whether the availability of data has increased sufficiently to potentially include assessment of such data in the investment process.

Additionally, PAI indicators are considered as part of the requirement of the Sub-Fund to invest more than 80% into Sustainable Investments. PAI indicators are used as part of the DNSH assessment. Investments in securities of issuers who do not pass the DNSH assessment are not counted as sustainable investments.

The following PAI indicators are considered:

Applicable to corporate issuers

- GHG Emissions
- Carbon footprint
- GHG Intensity of investee companies
- Exposure to companies active in the fossil fuel sector
- Share of non-renewable energy consumption and production
- Energy consumption intensity per high impact climate sector
- Activities negatively affecting biodiversity-sensitive areas
- Emissions to water
- Hazardous waste ratio
- Violation of UN Global compact principles
- Lack of processes and compliance mechanisms to monitor compliance with UN Global Compact principles
- Unadjusted gender pay gap
- Board gender diversity
- Exposure to controversial weapons

Applicable to sovereign and supranational issuers

- GHG Intensity
- Investee countries subject to social violations

The information on the PAI indicators will be available in the end-year report of the Sub-Fund.



What investment strategy does this financial product follow?

The investment strategy guides investment decisions based on factors such as investment objectives and risk tolerance.

Allianz Green Bond's investment objective is to invest in Investment Grade rated Green Bonds of the global Bond Markets denominated in currencies of OECD countries in accordance with the Green Bond Strategy.

The Green Bond Strategy's aim is to invest into Green Bonds that are a specific asset category where the bond proceeds are specifically earmarked to raise money for climate and environmental projects.

The Investment Manager analyses the bond structure to determine whether it is in line with the Green Bond Principles or not. The respect of those four principles below is a prerequisite for a bond to be considered a Green Bond:

- A formal statement in the use of proceeds section of the bond prospectus in question stating that the proceeds will be used to finance "green" / climate projects
- Internal process by the issuer to identify qualifying projects based on sound methodology and clear criteria
- Management of the proceeds to make sure that they will be allocated to the identified projects and not to other general expenses / investments

- Reporting, at least annually, of the status of the use of proceeds, the status of projects and the actual environmental impact

In addition, a Sub-Fund's Investment Manager analyses the projects financed by the Green Bond's proceeds. To be eligible, those projects must be part of the green projects list defined internally by Allianz Global Investors based on research from the Climate Bonds Initiative (CBI), a world-class reputation organisation, which provides a science-based evaluation of the climate change mitigation impacts of the different types of projects.

The Investment Manager completes this analysis by also considering the Environment, Social, Governance, Human Rights and Business behaviour factors in the selection process of an issuer. The aforesaid sustainability factors are analysed through SRI Research by the Investment Manager in order to assess how sustainable development and long-term issues are taken into account in the strategy of an issuer. SRI Research means the overall process of identifying potential risks as well as potential opportunities of an investment in securities of an issuer related to the analysis of sustainability factors. SRI Research data combines external research data (which might have some limitations) with internal analyses. Based on a combination of the results of the external and/or internal analyses of the sustainability factors, an internal rating is derived monthly (SRI Rating) and is afterwards assigned to a corporate or sovereign issuer. In case the sustainability profile of the issuer is poor as measured by the average SRI Rating, the bonds issued by or from this issuer would not be eligible according to the Green Bond Strategy.

The last step of the Investment Manager's analysis is focused on the credibility of the respective issuer's approach regarding its transition to a low carbon model. The Investment Manager's intention is to favour Green Bonds from such issuers which have set up a sound strategy to mitigate the negative environmental impacts of their activities. The Investment Manager tries to identify such issuers which only make use of the Green Bond market solely for communication / marketing purposes and therefore will not invest in bonds issued by such issuers.

The Sub-Fund's general investment approach (Sub-Fund's applicable General Asset Class Principles in combination with its individual investment restrictions) is described in the prospectus.

● **What are the binding elements of the investment strategy used to select the investments to attain the sustainable investment objective?**

The investment strategy adheres to the following binding elements to attain the sustainable investment objective:

- Min. 85% of the Sub-Fund's assets are invested in Green Bonds.
- Green Bonds held in the portfolio are adhering to the minimum SRI rating threshold of 1 (out of a rating scale from 0 – 4; 0 being the worst rating and 4 the best rating).
- Commitment to a minimum sustainable investment (SI) share of 80%.
- Application of the following Sub-Fund specific exclusion criteria for direct investments:
 - securities issued by companies having a severe violation / breach of principles and guidelines such as the Principles of the United Nations Global Compact, the OECD Guidelines for Multinational Enterprises, and the United Nations Guiding Principles for Business and Human Rights on the grounds of problematic practices around human rights, labour rights, environment, and corruption issues,
 - securities issued by companies involved in controversial weapons (anti-personnel mines, cluster munitions, chemical weapons, biological weapons, depleted uranium, white phosphorus, and nuclear weapons), and securities issued by companies that derive more than 10% of their revenues from weapons, military equipment, and services,
 - securities issued by companies involved in the production of tobacco, and securities of companies involved in the distribution of tobacco with more than 5% of their revenues,
 - securities issued by companies that derive more than 30 % of their revenue from thermal coal extraction and securities issued by utility companies that generate more than 30% of their revenues from coal.

Direct investments in sovereign issuers with an insufficient freedom house index score are excluded.

The Sub-Fund specific exclusion criteria are based on information from an external data provider and coded in pre- and post-trade compliance. The review is performed at least half yearly.

● **What is the policy to assess good governance practices of the investee companies?**

Good governance principles are considered by screening out companies based on their involvement in controversies around international norms corresponding to the four good governance practices: sound

remuneration of staff and tax compliance.

management structures, employee relations, remuneration of staff and tax compliance. Companies having a severe violation in either of those areas will not be investible. For certain cases, flagged issuers shall be on a watch list. These companies will appear on this watch list when the Investment Manager believes that engagement may lead to improvements or when the company is assessed to take remedial actions. Companies on the watch list remain investible unless the Investment Manager believes that the engagement or the remedial actions of the company does not lead to the desired remedy of the severe controversy.

In addition, the Sub-Fund's Investment Manager is committed to actively encourage open dialogues with investee companies on corporate governance, proxy voting and broader sustainability issues in advance of shareholder meetings (regularly for direct investments in shares). The Sub-Fund's Investment Manager's approach to proxy voting and company engagement is set out in the Management Company's Stewardship Statement.



What is the asset allocation and the minimum share of sustainable investments?

Asset allocation describes the share of investments in specific assets.

In order to mobilize capital markets towards the transition to a low carbon society, natural capital preservation and adaptation to climate change the Sub-Fund invests primarily in Green Bonds. Min. 80% of the Sub-Funds' assets will be invested in Sustainable Investments.

The minimum percentage of investments with an environmental objective is 80%. The minimum percentage of investments that are aligned with the EU Taxonomy is 0.01%. The Sub-Fund's Investment Manager does not commit to a minimum share of socially sustainable investments.



● How does the use of derivatives attain the sustainable investment objective?

Not applicable



To what minimum extent are sustainable investments with an environmental objective aligned with the EU Taxonomy?

The Taxonomy-aligned investments include debt and/or equity in environmentally sustainable economic activities aligned with the EU-Taxonomy. The minimum percentage of investments that are aligned with the EU Taxonomy is 0.01%. Taxonomy-aligned data is provided by an external data provider. The Investment Manager has assessed the quality of such data. The data will not be subject to an assurance provided by auditors or a review by third parties. The data will not reflect any data in government bonds. As of today, there is no recognized methodology available to determine the proportion of Taxonomy-aligned activities when investing in government bonds.

Taxonomy-aligned activities in this disclosure are based on share of turnover. Pre-contractual figures use turnover as its financial metric as a default in line with the regulatory requirements and based on the fact that complete, verifiable or up-to date data for CAPEX and/or OPEX as financial metric is even less available.

Taxonomy-aligned data is only in rare cases data reported by companies in accordance with the EU Taxonomy. The data provider has derived Taxonomy-aligned data from other available equivalent public data.

Taxonomy-aligned activities are expressed as a share of:

- **turnover** reflecting the share of revenue from green activities of investee companies
- **capital expenditure** (CapEx) showing the green investments made by investee companies, e.g. for a transition to a green economy.
- **operational expenditure** (OpEx) reflecting green operational activities of investee companies.

● **Does the financial product invest in fossil gas and/or nuclear energy related activities that comply with the EU Taxonomy¹?**

- Yes:
- In fossil gas
 - In nuclear energy
- No

The Sub-Fund does not pursue any investments in fossil gas and/or nuclear energy related activities that comply with the EU Taxonomy. Nevertheless, as result of this investment strategy, investments may occur in corporates which are also active in these activities. Further information will be provided as part of the annual reporting, if relevant.

The two graphs below show in green the minimum percentage of investments that are aligned with the EU Taxonomy. As there is no appropriate methodology to determine the Taxonomy-alignment of sovereign bonds, the first graph shows the Taxonomy-alignment in relation to all the investments of the financial product including sovereign bonds, while the second graph shows the Taxonomy-alignment only in relation to the investments of the financial product other than sovereign bonds.*

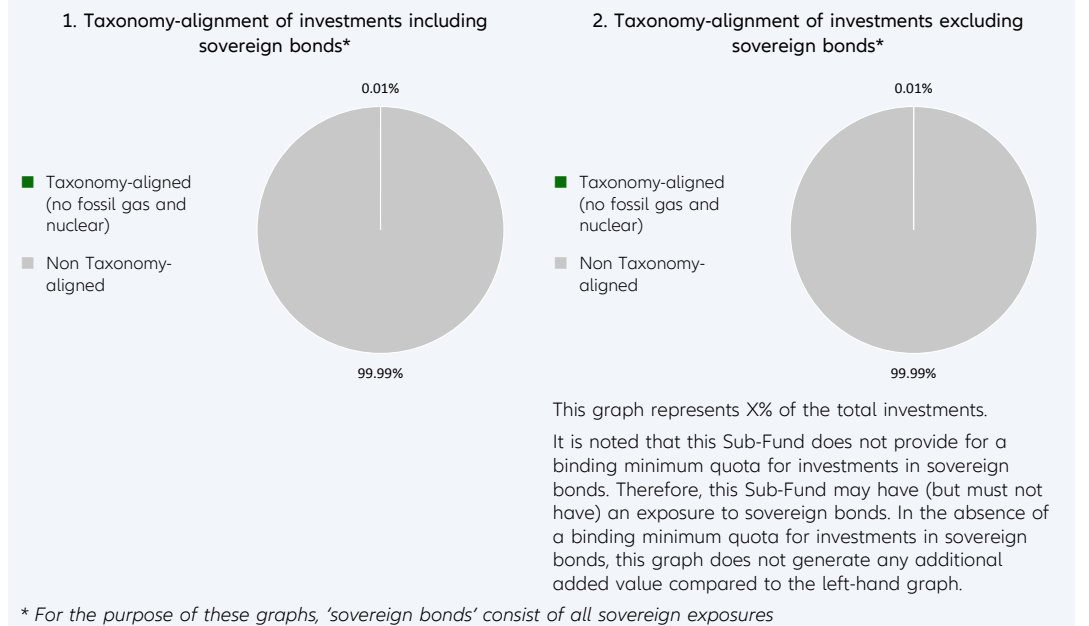

Enabling activities directly enable other activities to make a substantial contribution to an environmental objective.

Transitional activities are activities for which low-carbon alternatives are not yet available and among others have greenhouse gas emission levels corresponding to the best performance.

● **What is the minimum share of investments in transitional and enabling activities?**

The Sub-Fund's Investment Manager does not commit to a split of minimum taxonomy alignment into transitional, enabling activities and own performance.



What is the minimum share of sustainable investments with an environmental

¹ Fossil gas and/or nuclear related activities will only comply with the EU Taxonomy where they contribute to limiting climate change ("climate change mitigation") and do not significantly harm any EU Taxonomy objective - see explanatory note in the left hand margin. The full criteria for fossil gas and nuclear energy economic activities that comply with the EU Taxonomy are laid down in Commission Delegated Regulation (EU) 2022/1214.



are environmentally sustainable investments that **do not take into account the criteria** for environmentally sustainable economic activities under the EU Taxonomy.

objective that are not aligned with the EU Taxonomy?

Taxonomy-aligned investments are considered a sub-category of Sustainable Investments. If an investment is not Taxonomy-aligned since the activity is not yet covered under the EU Taxonomy or the positive contribution is not substantial enough to comply with the Taxonomy technical screening criteria, the investment can still be considered an environmentally Sustainable Investment provided it complies with all criteria. The total share of environmentally Sustainable Investments including EU Taxonomy of the Sub-Fund is at least 80%. The overall sustainable investment share may also include investments with an environmental objective in economic activities that do not qualify as environmentally sustainable under the EU Taxonomy.



What is the minimum share of sustainable investments with a social objective?

The Sub-Fund's Investment Manager does not commit to a minimum share of socially sustainable investments.



What investments are included under “#2 Not sustainable”, what is their purpose and are there any minimum environmental or social safeguards?

Under “#2 Not sustainable” parts of investments are included related to business activities which are not counted as Sustainable Investments. In addition, the Investment Manager might invest into cash, Targets Funds, or derivatives which might be used for efficient portfolio management (including risk hedging) and/or investment purposes, and Target Funds to benefit from a specific strategy. For those investments no environmental or social safeguards are applied.



Is a specific index designated as a reference benchmark to meet the sustainable investment objective?

Yes, the Sub-Fund has assigned the ICE BOFAML GREEN BOND INDEX as a Benchmark.

Reference benchmarks are indexes to measure whether the financial product attains the sustainable investment objective.

● How does the reference benchmark take into account sustainability factors in a way that is continuously aligned with the sustainable investment objective?

The Sub-Fund uses a Green Bond Benchmark which is however not completely aligned with the sustainable investment objective promoted by the Sub-Fund. ICE BofA Green Bond Index tracks the performance of securities issued for qualified “green” purposes. Qualifying bonds must have a clearly designated use of proceeds that is solely applied toward projects or activities that promote climate change mitigation or adaptation or other environmental sustainability purposes as outlined by the ICMA Green Bond Principles. The specific screening and exclusion criteria might deviate from the Sub-Fund's investment strategy.

● How is the alignment of the investment strategy with the methodology of the index ensured on a continuous basis?

The benchmark is not continuously aligned as the screening and exclusion criteria of the benchmark deviate from the Sub-Fund's investment strategy.

● How does the designated index differ from a relevant broad market index?

The benchmark tracks the performance of securities issued for qualified “green” purposes.

● Where can the methodology used for the calculation of the designated index be found?

Details of the Benchmark's methodology may be found at https://www.theice.com/publicdocs/Green_Bond_Index.pdf and at www.theice.com.



Where can I find more product specific information online?

More product-specific information can be found on the website: <https://regulatory.allianzgi.com/SFDR>

Template pre-contractual disclosure for the financial products referred to in Article 8, paragraphs 1, 2 and 2a, of Regulation (EU) 2019/2088 and Article 6, first paragraph, of Regulation (EU) 2020/852

Product name:

Allianz Green Future

Legal entity identifier: 5299000ME98AQUG1H594

Environmental and/or social characteristics

Sustainable investment means an investment in an economic activity that contributes to an environmental or social objective, provided that the investment does not significantly harm any environmental or social objective and that the investee companies follow good governance practices.

The **EU Taxonomy** is a classification system laid down in Regulation (EU) 2020/852, establishing a list of **environmentally sustainable economic activities**. That Regulation does not include a list of socially sustainable economic activities. Sustainable investments with an environmental objective might be aligned with the Taxonomy or not.

Does this financial product have a sustainable investment objective?	
Yes	No
<input type="checkbox"/> It will make a minimum of sustainable investments with an environmental objective : ___% <input type="checkbox"/> in economic activities that qualify as environmentally sustainable under the EU Taxonomy <input type="checkbox"/> in economic activities that do not qualify as environmentally sustainable under the EU Taxonomy	<input checked="" type="checkbox"/> It promotes Environmental/Social (E/S) characteristics and while it does not have as its objective a sustainable investment, it will have a minimum proportion of 5.00% of sustainable investments <input checked="" type="checkbox"/> with an environmental objective in economic activities that qualify as environmentally sustainable under the EU Taxonomy <input checked="" type="checkbox"/> with an environmental objective in economic activities that do not qualify as environmentally sustainable under the EU Taxonomy <input checked="" type="checkbox"/> with a social objective
<input type="checkbox"/> It will make a minimum of sustainable investments with a social objective ___%	<input type="checkbox"/> It promotes E/S characteristics, but will not make any sustainable investments



What environmental and/or social characteristics are promoted by this financial product?

Allianz Green Future (the "Sub-Fund") promotes a broad range of environmental and/or social characteristics. The Sub-Fund invests at least 90% of its assets following the "Multi Asset Sustainability Strategy" which includes, but is not limited to, various sustainability strategies of the management company and/or, invests in Green Bonds and/or Social Bonds, and/or Sustainability Bonds and/or SFDR Article 8 & 9 Target Funds ("SFDR Target Funds").

Depending on the sustainability strategy selected by the Investment Manager the promoted environmental and/or social characteristics could comprise environmental, social, human rights, governance, business behaviour factors or investments in companies providing solutions that create positive environmental and social outcomes.

In addition, sustainable minimum exclusion criteria apply.

No reference benchmark has been designated for the purpose of attaining the environmental and/or social characteristics promoted by the Sub-Fund.

- **What sustainability indicators are used to measure the attainment of each of the environmental or social characteristics promoted by this financial product?**

As part of the Multi Asset Sustainability Strategy the Investment Manager allocates at least 90% of Fund's assets in various sustainability approaches.

Sustainability indicators measure how the environmental or social characteristics promoted by the financial product are attained.

To measure the attainment of the environmental and/or social characteristics the following sustainability indicators are used and reported on, at the fiscal year end:

- The actual percentage of the Sub-Fund's assets invested in Green Bonds, and/or Social Bonds, and/or Sustainability Bonds and/or in SFDR Target Funds and/or in Equities and/or Debt Securities in accordance with the Multi Asset Sustainability Strategy.
- In case the Investment Manager decides to directly invest in Debt or Equity Securities as part of the Multi Asset Sustainability Strategy the adherence to the respective binding element will be reported.
- Confirmation that Principal Adverse Impacts (PAIs) of investment decisions on sustainability factors are considered through the application of exclusion criteria (with exception of cash, derivatives, external Target Funds and internal Target Funds not following a sustainability strategy).

● **What are the objectives of the sustainable investments that the financial product partially intends to make and how does the sustainable investment contribute to such objectives?**

Sustainable investments contribute to environmental and/or social objectives, for which the Investment Manager uses as reference frameworks, among others, the UN Sustainable Development Goals (SDGs), as well as the objectives of the EU Taxonomy:

1. Climate Change Mitigation
2. Climate Change Adaptation
3. Sustainable Use and Protection of Water and Marine Resources
4. Transition to a Circular Economy
5. Pollution Prevention and Control
6. Protection and Restoration of Biodiversity and Ecosystems

The assessment of the positive contribution to the environmental or social objectives is based on a proprietary framework which combines quantitative elements with qualitative inputs from internal research. The methodology applies first a quantitative breakdown of a securities issuer into its business activities. The qualitative element of the framework is an assessment if business activities contribute positively to an environmental or a social objective.

To calculate the positive contribution on the Sub-Fund level the revenue share of each issuer attributable to business activities contributing to environmental and/or social objectives is considered provided the issuer is satisfying the Do No Significant Harm ("DNSH") and Good Governance principles, and an asset-weighted aggregation is performed as a second step. Moreover, for certain types of securities, which finance specific projects contributing to environmental or social objectives the overall investment is considered to contribute to environmental and/or social objectives, but also for these a DNSH as well as a Good Governance check for issuers is performed.

● **How do the sustainable investments that the financial product partially intends to make, not cause significant harm to any environmental or social sustainable investment objective?**

In order to ensure that Sustainable Investments do not significantly harm any other environmental and/or social objective, the Investment Manager is leveraging the PAI indicators, whereby significance thresholds have been defined to identify significantly harmful issuers. Issuers not meeting the significance threshold can be engaged for a limited time period to remediate the adverse impact. Otherwise, if the issuer does not meet the defined significance thresholds twice subsequently or in case of a failed engagement, it does not pass the DNSH assessment. Investments in securities of issuers which do not pass the DNSH assessment are not counted as sustainable investments.

● **How have the indicators for adverse impacts on sustainability factors been taken into account?**

All mandatory PAI indicators are considered either as part of the application of the exclusion criteria or through thresholds on a sectorial or absolute basis. Significance thresholds have been defined and they refer to qualitative or quantitative criteria.

Recognizing the lack of data coverage for some of the PAI indicators equivalent data points are used to assess PAI indicators when applying the DNSH assessment, when relevant, for the following indicators for corporates: share of non-renewable energy consumption and production, activities negatively affecting biodiversity-sensitive areas, emissions to water, lack of processes and compliance mechanisms to monitor compliance with UNGC principles and OECD Guidelines for Multinational Enterprises; for sovereigns: GHG Intensity and investee countries subject to social violations. In case of securities which

Principal adverse impacts are the most significant negative impacts of investment decisions on sustainability factors relating to environmental, social and employee matters, respect for human rights, anti-corruption and anti-bribery matters.

finance specific projects contributing to environmental or social objectives equivalent data at project level might be used to ensure that Sustainable Investments do not significantly harm any other environmental and/or social objective. The Investment Manager will strive to increase data coverage for PAI indicators with low data coverage by engaging with issuers and data providers. The Investment Manager will regularly evaluate whether the availability of data has increased sufficiently to potentially include assessment of such data in the investment process.

- *How are the sustainable investments aligned with the OECD Guidelines for Multinational Enterprises and the UN Guiding Principles on Business and Human Rights? Details:*

The Investment Manager's sustainable minimum exclusion list screens out companies based on their involvement in controversial practices against international norms. The core normative framework consists of the Principles of the UN Global Compact, the OECD Guidelines for Multinational Enterprises and the UN Guiding Principles for Business and Human Rights. Securities issued by companies having a severe violation of these frameworks will be restricted from the investment universe.

The EU Taxonomy sets out a "do not significant harm" principle by which Taxonomy-aligned investments should not significantly harm EU Taxonomy objectives and is accompanied by specific EU criteria.

The "do not significant harm" principle applies only to those investments underlying the financial product that take into account the EU criteria for environmentally sustainable economic activities. The investments underlying the remaining portion of this financial product do not take into account the EU criteria for environmentally sustainable economic activities.

Any other sustainable investments must also not significantly harm any environmental or social objectives.



Does this financial product consider principal adverse impacts on sustainability factors?

Yes

No

The Management Company has joined the Net Zero Asset Manager Initiative and considers PAI indicators through stewardship including engagement, both are relevant to mitigate potential adverse impact as a company.

Due to the commitment to the Net Zero Asset Manager Initiative, the Management Company aims to reduce greenhouse gas emissions in partnership with asset owner clients on decarbonisation goals, consistent with an ambition to reach net zero emission by 2050 or sooner across all assets under management. As part of this objective the Management Company will set an interim target for the proportion of assets to be managed in line with the attainment of net zero emissions by 2050 or sooner.

The Sub-Fund's Investment Manager addresses PAI indicators regarding greenhouse gas emission, biodiversity, water, waste as well as social and employee matters for corporate issuers, and, where relevant, the freedom house index is applied to investments in sovereigns. PAI indicators are considered within the Investment Manager's investment process through the means of exclusions as described in the "binding elements" section of the Sub-Fund.

The data coverage for the data required for the PAI indicators is heterogenous. The data coverage related to biodiversity, water and waste is low and the related PAI indicators are considered through exclusion of securities issued by companies having a severe violation / breach of principles and guidelines such as the Principles of the United Nations Global Compact, the OECD Guidelines for Multinational Enterprises, and the United Nations Guiding Principles for Business and Human Rights on the grounds of problematic practices around human rights, labour rights, environment, and corruption issues. Therefore, the Investment Manager will strive to increase data coverage for PAI indicators with low data coverage. The Investment Manager will regularly evaluate whether the availability of data has increased sufficiently to potentially include assessment of such data in the investment process.

The following PAI indicators are considered:

Applicable to corporate issuers

- GHG Emissions
- Carbon footprint
- GHG Intensity of investee companies
- Exposure to companies active in the fossil fuel sector

- Activities negatively affecting biodiversity-sensitive areas
- Emissions to water
- Hazardous waste ratio
- Violation of UN Global compact principles
- Lack of processes and compliance mechanisms to monitor compliance with UN Global Compact principles
- Board gender diversity
- Exposure to controversial weapons

Applicable to sovereign and supranational issuers

- Investee countries subject to social violations

The information on the PAI indicators will be available in the end-year report of the Sub-Fund.



What investment strategy does this financial product follow?

The investment strategy guides investment decisions based on factors such as investment objectives and risk tolerance.

Allianz Green Future's investment objective is to invest in a broad range of asset classes, in particular in the global bond-, global equity-, and money markets. The Sub-Fund achieves its investment objective by investing in internal SFDR Target Funds.

A Sub-Fund managed according to the Multi Asset Sustainability Strategy ("MAS Strategy") invests in (i) Equities and / or Debt Securities of companies that either provide for environmental and/or social characteristics and/or pursue activities contributing to an environmental or social objective and / or invests (ii) in Green Bonds and/or Social Bonds, and/or in Sustainability Bonds and/or (iii) in SFDR Target Funds.

In case of direct investments in Equities and/or Debt Securities, the Sub-Fund's Investment Manager may choose one or more of the below strategies that promote environmental and/or social characteristics and/or pursue activities contributing to an environmental or social objective:

- SRI Strategy

The Sub-Fund or strategy promotes environmental and social characteristics through integrating environmental, social, human rights, governance and business behaviour factors into the Sub-Fund's investment process through a best-in-class approach. This encompasses the evaluation of corporate or sovereign issuers based on an SRI Rating that it is used to construct the portfolio.

- Climate Engagement with Outcome Strategy

The Sub-Fund or strategy promotes environmental characteristics through the engagement with the top 10 carbon emitting issuers to encourage their transition pathway to a low carbon economy by setting objectives which are sector specific.

- SDG-Aligned & SDG-Aligned Type A Strategy

The Sub-Fund's or strategy's Sustainable Investment objective is to invest in Equities and/or in Debt Securities of companies providing solutions that create positive environmental and social outcomes, as assessed by the contribution of companies' outputs to the attainment of one or more of the SDGs or other Sustainable Investment objectives, which the Sub-Fund's Investment Manager may additionally determine and to which the companies contribute to.

- Green Bond Strategy

The Sub-Fund's or strategy's Sustainable Investment objective is to mobilize capital markets towards the transition to a low carbon society, natural capital preservation and adaptation to climate change. The Sub-Fund or strategy invests primarily in Green Bonds financing climate change mitigation or adaptation projects or other environmental sustainability projects, notably in the following fields: energy efficiency, renewable energy, raw materials, water and land, waste management, greenhouse gas emissions reduction, biodiversity preservation or circular economy.

- Green Transition Strategy

The Sub-Fund or strategy promotes environmental and/or social characteristics through the mobilization of capital markets towards the transition to a low carbon society, natural capital preservation and adaptation to climate change.

- KPI Strategy (Absolute)

A Sub-Fund or strategy managed according to the Sustainability Key Performance Indicator Strategy (Absolute) ("KPI Strategy (Absolute)") promotes environmental objectives by applying an investment objective related to an environmental key performance indicator referred to as "Sustainability KPI" to provide transparency on the measurable sustainability outcome pursued. The "Sustainability KPI" to be measured is the GHG Intensity defined by the Weighted Average GHG Intensity (Sales) of issuers included in the Fund's portfolio. GHG Intensity will be addressed by ensuring a pre-determined year-on-year improvement pathway of the weighted average GHG Intensity on Fund's portfolio level at the Fund's fiscal year ends.

- KPI Strategy (Relative)

A Sub-Fund or strategy managed according to the Sustainability Key Performance Indicator Strategy (Relative) ("KPI Strategy (Relative)") promotes environmental objectives by applying an investment objective related to an environmental key performance indicator referred to as "Sustainability KPI" to provide transparency on the measurable sustainability outcome pursued. The "Sustainability KPI" to be measured is the GHG Intensity of issuers acquired by the Fund defined by the Weighted Average GHG Intensity (Sales). GHG Intensity of the Fund will be addressed by outperforming the Fund's benchmark (respectively the Weighted Average GHG Intensity of the issuers included in the Fund's benchmark) in terms of Weighted Average GHG Intensity.

- ESG Score Strategy

A Sub-Fund or strategy managed according to the ESG Score Strategy promotes Environment, Social and Governance factors through the ESG Score Strategy. The ESG Score Strategy aims to measure a company's resilience to long-term risks across the three pillars of Environment, Social and Governance. ESG pillars will be addressed by outperforming the Weighted Average ESG Score of issuers whose shares have been acquired by the Fund against the Weighted Average ESG Score of issuers which are components of Fund's benchmark.

- KPI Strategy (Absolute Threshold)

A Sub-Fund or strategy managed according to the Sustainability Key Performance Indicator Strategy (Absolute Threshold) ("KPI Strategy (Absolute Threshold)") targets a specific minimum allocation into Sustainable Investments. Sustainable investments are investments in economic activities which contribute to environmental and/or social objectives, for which the Investment Managers uses as reference frameworks the UN Sustainable Development Goals (SDGs), as well as the objectives of the EU Taxonomy.

The Sub-Fund's general investment approach (Sub-Fund's applicable General Asset Class Principles in combination with its individual investment restrictions) is described in the prospectus.

● **What are the binding elements of the investment strategy used to select the investments to attain each of the environmental or social characteristics promoted by this financial product?**

A Sub-Fund managed according to the Multi Asset Sustainability Strategy ("MAS Strategy") invests in (i) Equities and / or Debt Securities of companies that either provide for environmental and/or social characteristics and/or pursue activities contributing to an environmental or social objective and / or invests (ii) in Green Bonds and/or Social Bonds, and/or in Sustainability Bonds and/or (iii) in SFDR Target Funds.

Overall, the Investment Manager is required to invest min 90% of Sub-Fund's assets in SFDR Target Funds and/or in Equities and/or Debt Securities in accordance with the Multi Asset Sustainability Strategy.

- Application of the following sustainable minimum exclusion criteria for direct investments (with exception of cash, derivatives, external Target Funds, and internal Target Funds not following a sustainable strategy):
- securities issued by companies having a severe violation / breach of principles and guidelines such as the Principles of the United Nations Global Compact, the OECD Guidelines for Multinational Enterprises, and the United Nations Guiding Principles for Business and Human Rights on the grounds of problematic practices around human rights, labour rights, environment, and corruption issues,
- securities issued by companies involved in controversial weapons (anti-personnel mines, cluster munitions, chemical weapons, biological weapons, depleted uranium, white phosphorus, and nuclear weapons),
- securities issued by companies that derive more than 10% of their revenues from weapons, military equipment, and services,
- securities issued by companies that derive more than 10% of their revenue from thermal coal extraction
- securities issued by utility companies that generate more than 20% of their revenues from coal,
- securities issued by companies involved in the production of tobacco, and securities issued by companies involved in the distribution of tobacco with more than 5% of their revenues

Direct investments in sovereign issuers with an insufficient freedom house index score are excluded.

The sustainable minimum exclusion criteria are based on information from an external data provider and coded in pre- and post-trade compliance. The review is performed at least half yearly.

- **What is the committed minimum rate to reduce the scope of the investments considered prior to the application of that investment strategy?**

The Sub-Fund does not commit to reduce the scope of the investments by a certain minimum rate.

- **What is the policy to assess good governance practices of the investee companies?**

Good governance principles are considered by screening out companies based on their involvement in controversies around international norms corresponding to the four good governance practices: sound management structures, employee relations, remuneration of staff and tax compliance. Companies having a severe violation in either of those areas will not be investible. For certain cases, flagged issuers shall be on a watch list. These companies will appear on this watch list when the Investment Manager believes that engagement may lead to improvements or when the company is assessed to take remedial actions. Companies on the watch list remain investible unless the Investment Manager believes that the engagement or the remedial actions of the company does not lead to the desired remedy of the severe controversy.

In addition, the Sub-Fund’s Investment Manager is committed to actively encourage open dialogues with investee companies on corporate governance, proxy voting and broader sustainability issues in advance of shareholder meetings (regularly for direct investments in shares). The Sub-Fund’s Investment Manager’s approach to proxy voting and company engagement is set out in the Management Company’s Stewardship Statement.

Good governance practices include sound management structures, employee relations, remuneration of staff and tax compliance.



What is the asset allocation planned for this financial product?

Asset allocation describes the share of investments in specific assets.

Min. 90% of the Sub-Funds’ assets are used to meet the environmental or social characteristics promoted by this Sub-Fund. A low portion of the Sub-Fund might contain assets which do not promote environmental or social characteristics. Example of such instruments are derivatives, cash and deposits, some Target Funds and investment with temporarily divergent or absent environmental, social, or good governance qualifications or investments outside of the specified quota to be invested as part of the Multi Asset Sustainability Strategy. Min. 5% of the Sub-Funds’ assets will be invested in Sustainable Investments. The minimum percentage of investments that are aligned with the EU Taxonomy is 0.01%. The Sub-Fund’s Investment Manager does not commit to a minimum share of environmentally Sustainable Investments that are not aligned with the EU Taxonomy. The Sub-Fund’s Investment Manager does not commit to a minimum share of socially sustainable investments. While the Sub-Fund cannot commit to a minimum share of environmentally or socially sustainable investments, such investments may be freely allocated to within the Sub-Fund aggregated sustainable investment commitment disclosed (min. 5%).

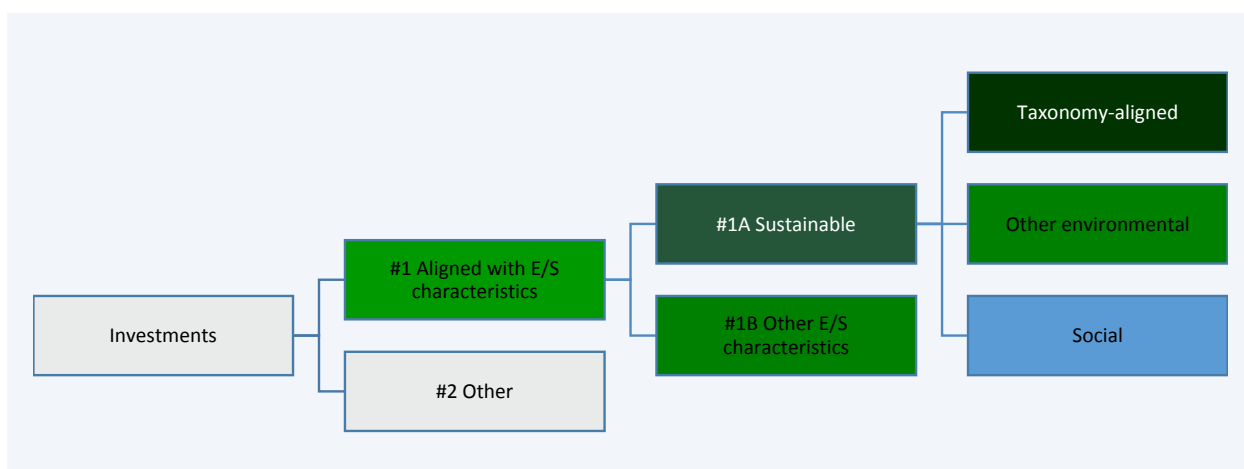

#1 Aligned with E/S characteristics includes the investments of the financial product used to attain the environmental or social characteristics promoted by the financial product.

#2 Other includes the remaining investments of the financial product which are neither aligned with the environmental or social characteristics, nor are qualified as sustainable investments.

The category #1 Aligned with E/S characteristics covers:
 - The sub-category #1A Sustainable covers sustainable investments with environmental or social objectives.
 - The sub-category #1B Other E/S characteristics covers investments aligned with the environmental or social characteristics that do not qualify as sustainable investments.

● How does the use of derivatives attain the environmental or social characteristics promoted by the financial product?

Not applicable



To what minimum extent are sustainable investments with an environmental objective aligned with the EU Taxonomy?

The Taxonomy-aligned investments include debt and/or equity in environmentally sustainable economic activities aligned with the EU-Taxonomy. The minimum percentage of investments that are aligned with the EU Taxonomy is 0.01%. Taxonomy-aligned data is provided by an external data provider. The Investment Manager has assessed the quality of such data. The data will not be subject to an assurance provided by auditors or a review by third parties. The data will not reflect any data in government bonds. As of today, there is no recognized methodology available to determine the proportion of Taxonomy-aligned activities when investing in government bonds.

Taxonomy-aligned activities in this disclosure are based on share of turnover. Pre-contractual figures use turnover as its financial metric as a default in line with the regulatory requirements and based on the fact that complete, verifiable or up-to date data for CAPEX and/or OPEX as financial metric is even less available.

Taxonomy-aligned data is only in rare cases data reported by companies in accordance with the EU Taxonomy. The data provider has derived Taxonomy-aligned data from other available equivalent public data.

● Does the financial product invest in fossil gas and/or nuclear energy related activities that comply with the EU Taxonomy ¹?

- Yes:
 - In fossil gas
 - In nuclear energy
- No

The Sub-Fund does not pursue any investments in fossil gas and/or nuclear energy related activities that comply with the EU Taxonomy. Nevertheless, as result of this investment strategy, investments may occur in corporates which are also active in these activities. Further information will be provided as part of the annual reporting, if relevant.

The two graphs below show in green the minimum percentage of investments that are aligned with the EU Taxonomy. As there is no appropriate methodology to determine the Taxonomy-alignment of sovereign bonds*, the first graph shows the Taxonomy-alignment in relation to all the investments of the financial product including sovereign bonds, while the second graph shows the Taxonomy-alignment only in relation to the investments of the financial product other than sovereign bonds.

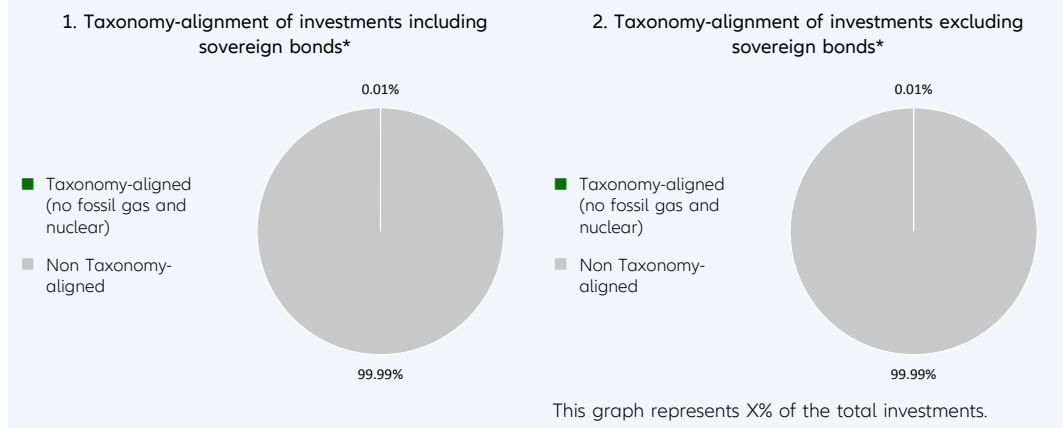

¹ Fossil gas and/or nuclear related activities will only comply with the EU Taxonomy where they contribute to limiting climate change ("climate change mitigation") and do not significantly harm any EU Taxonomy objective - see explanatory note in the left hand margin. The full criteria for fossil gas and nuclear energy economic activities that comply with the EU Taxonomy are laid down in Commission Delegated Regulation (EU) 2022/1214.

It is noted that this Sub-Fund does not provide for a binding minimum quota for investments in sovereign bonds. Therefore, this Sub-Fund may have (but must not have) an exposure to sovereign bonds. In the absence of a binding minimum quota for investments in sovereign bonds, this graph does not generate any additional added value compared to the left-hand graph.

* For the purpose of these graphs, 'sovereign bonds' consist of all sovereign exposures

Enabling activities directly enable other activities to make a substantial contribution to an environmental objective.

Transitional activities are activities for which low-carbon alternatives are not yet available and among others have greenhouse gas emission levels corresponding to the best performance.

● What is the minimum share of investments in transitional and enabling activities?

The Sub-Fund's Investment Manager does not commit to a split of minimum taxonomy alignment into transitional, enabling activities and own performance.



What is the minimum share of sustainable investments with an environmental objective that are not aligned with the EU Taxonomy?

Taxonomy-aligned investments are considered a sub-category of Sustainable Investments. If an investment is not Taxonomy-aligned since the activity is not yet covered under the EU Taxonomy or the positive contribution is not substantial enough to comply with the Taxonomy technical screening criteria, the investment can still be considered an environmentally Sustainable Investment provided it complies with all criteria. The Investment Manager does not commit to a minimum share of environmentally Sustainable Investments that are not aligned with the EU Taxonomy. The overall sustainable investment share may also include investments with an environmental objective in economic activities that do not qualify as environmentally sustainable under the EU Taxonomy, and while the Sub-Fund cannot commit to a minimum share of environmentally or socially sustainable investments, such investments may be freely allocated to within the Sub-Fund aggregated sustainable investment commitment disclosed (min. 5%).



are sustainable investments with an environmental objective that **do not take into account the criteria** for environmentally sustainable economic activities under the EU Taxonomy.



What is the minimum share of socially sustainable investments?

The Investment Manager defines Sustainable Investments based on internal research, which uses, among others, the UN Sustainable Development Goals (SDGs), as well as the objectives of the EU Taxonomy as reference frameworks. The Investment Manager does not commit to a minimum share of socially Sustainable Investments, as the SDGs contain environmental as well as social objectives. The overall sustainable investment share may also include investments with a social objective, and while the Sub-Fund cannot commit to a minimum share of environmentally or socially sustainable investments, such investments may be freely allocated to within the Sub-Fund aggregated sustainable investment commitment disclosed (min. 5%).



What investments are included under "#2 Other", what is their purpose and are there any minimum environmental or social safeguards?

Under "#2 Other" investments into cash, Target Funds, or derivatives can be included. Derivatives might be used for efficient portfolio management (including risk hedging) and/or investment purposes, and Target Funds to benefit from a specific strategy. For those investments no environmental or social safeguards are applied.



Is a specific index designated as a reference benchmark to determine whether this financial product is aligned with the environmental and/or social characteristics that it promotes?

No reference benchmark has been designated for the purpose of attaining the environmental and/or social characteristics promoted by the Sub-Fund.

Reference benchmarks are indexes to measure whether the financial product attains the environmental or social characteristics that they promote.

- How is the reference benchmark continuously aligned with each of the environmental or social characteristics promoted by the financial product?
Not applicable
- How is the alignment of the investment strategy with the methodology of the index ensured on a continuous basis?
Not applicable
- How does the designated index differ from a relevant broad market index?
Not applicable
- Where can the methodology used for the calculation of the designated index be found?
Not applicable



Where can I find more product specific information online?

More product-specific information can be found on the website: <https://regulatory.allianzgi.com/SFDR>

Template pre-contractual disclosure for the financial products referred to in Article 8, paragraphs 1, 2 and 2a, of Regulation (EU) 2019/2088 and Article 6, first paragraph, of Regulation (EU) 2020/852

Product name:

Allianz Green Transition Bond

Legal entity identifier: 529900QSKNARO960RK57

Environmental and/or social characteristics

Sustainable investment means an investment in an economic activity that contributes to an environmental or social objective, provided that the investment does not significantly harm any environmental or social objective and that the investee companies follow good governance practices.

The **EU Taxonomy** is a classification system laid down in Regulation (EU) 2020/852, establishing a list of **environmentally sustainable economic activities**. That Regulation does not include a list of socially sustainable economic activities. Sustainable investments with an environmental objective might be aligned with the Taxonomy or not.

Does this financial product have a sustainable investment objective?	
<input checked="" type="radio"/> <input checked="" type="radio"/> Yes	<input checked="" type="radio"/> <input type="radio"/> No
<input type="checkbox"/> It will make a minimum of sustainable investments with an environmental objective: ___% <ul style="list-style-type: none"> <input type="checkbox"/> in economic activities that qualify as environmentally sustainable under the EU Taxonomy <input type="checkbox"/> in economic activities that do not qualify as environmentally sustainable under the EU Taxonomy 	<input checked="" type="checkbox"/> It promotes Environmental/Social (E/S) characteristics and while it does not have as its objective a sustainable investment, it will have a minimum proportion of 20.00% of sustainable investments <ul style="list-style-type: none"> <input checked="" type="checkbox"/> with an environmental objective in economic activities that qualify as environmentally sustainable under the EU Taxonomy <input checked="" type="checkbox"/> with an environmental objective in economic activities that do not qualify as environmentally sustainable under the EU Taxonomy <input checked="" type="checkbox"/> with a social objective
<input type="checkbox"/> It will make a minimum of sustainable investments with a social objective ___%	<input type="checkbox"/> It promotes E/S characteristics, but will not make any sustainable investments



What environmental and/or social characteristics are promoted by this financial product?

Allianz Green Transition Bond (the "Sub-Fund") promotes the mobilization of capital markets towards the transition to a low carbon society, natural capital preservation and adaptation to climate change. The Sub-Fund invests primarily in

- Green Bonds financing climate change mitigation or adaptation projects or other environmental sustainability projects
- in Debt Securities whose issuers commit to future improvements in sustainability outcomes
- in Debt Securities issued by sovereign issuers which have been bindingly ratified the Paris Agreement

Sustainable minimum exclusion criteria for direct investments apply.

A composite reference benchmark has been designated for the purpose of attaining the environmental and/or social characteristics promoted by the Sub-Fund.

● What sustainability indicators are used to measure the attainment of each of the environmental or social characteristics promoted by this financial product?

To measure the attainment of the environmental and/or social characteristics the following sustainability indicators are used and reported on, at the fiscal year end:

- The actual percentage of the Sub-Fund's assets invested in green transition related assets. This comprises Green Bonds; and issuers explicitly committing to future improvements in sustainability outcomes with a predefined timeline, including but not limited to issuers participating in the Science

Sustainability indicators measure how the environmental or social characteristics promoted by the financial product are attained.

Based Target (SBT) initiative; as well as Sovereign issuers which have bindingly ratified the Paris Agreement, and which have a sufficient Freedom House Index score. Issuers taking part to the SBT initiative commit defined targets to reduce greenhouse gas (GHG) emissions in line with the agreement as of April 2016 within the United Nations Framework Convention on Climate Change (UNFCCC), on climate change mitigation, adaptation, and finance (the “Paris Agreement”).

- Adherence to a minimum SRI Rating of 1 for Green Bonds & SBTi issuers held in the portfolio (out of a scale from 0-4; 0 being the worst rating and 4 the best rating).
 - Confirmation that Principal Adverse Impacts (PAIs) of investment decisions on sustainability factors are considered through the application of exclusion criteria.
- **What are the objectives of the sustainable investments that the financial product partially intends to make and how does the sustainable investment contribute to such objectives?**

Sustainable investments contribute to environmental and/or social objectives, for which the Investment Manager uses as reference frameworks, among others, the UN Sustainable Development Goals (SDGs), as well as the objectives of the EU Taxonomy:

1. Climate Change Mitigation
2. Climate Change Adaptation
3. Sustainable Use and Protection of Water and Marine Resources
4. Transition to a Circular Economy
5. Pollution Prevention and Control
6. Protection and Restoration of Biodiversity and Ecosystems

The assessment of the positive contribution to the environmental or social objectives is based on a proprietary framework which combines quantitative elements with qualitative inputs from internal research. The methodology applies first a quantitative breakdown of a securities issuer into its business activities. The qualitative element of the framework is an assessment if business activities contribute positively to an environmental or a social objective.

To calculate the positive contribution on the Sub-Fund level the revenue share of each issuer attributable to business activities contributing to environmental and/or social objectives is considered provided the issuer is satisfying the Do No Significant Harm (“DNSH”) and Good Governance principles, and an asset-weighted aggregation is performed as a second step. Moreover, for certain types of securities, which finance specific projects contributing to environmental or social objectives the overall investment is considered to contribute to environmental and/or social objectives, but also for these a DNSH as well as a Good Governance check for issuers is performed.

- **How do the sustainable investments that the financial product partially intends to make, not cause significant harm to any environmental or social sustainable investment objective?**

In order to ensure that Sustainable Investments do not significantly harm any other environmental and/or social objective, the Investment Manager is leveraging the PAI indicators, whereby significance thresholds have been defined to identify significantly harmful issuers. Issuers not meeting the significance threshold can be engaged for a limited time period to remediate the adverse impact. Otherwise, if the issuer does not meet the defined significance thresholds twice subsequently or in case of a failed engagement, it does not pass the DNSH assessment. Investments in securities of issuers which do not pass the DNSH assessment are not counted as sustainable investments.

- **How have the indicators for adverse impacts on sustainability factors been taken into account?**

All mandatory PAI indicators are considered either as part of the application of the exclusion criteria or through thresholds on a sectorial or absolute basis. Significance thresholds have been defined and they refer to qualitative or quantitative criteria.

Recognizing the lack of data coverage for some of the PAI indicators equivalent data points are used to assess PAI indicators when applying the DNSH assessment, when relevant, for the following indicators for corporates: share of non-renewable energy consumption and production, activities negatively affecting biodiversity-sensitive areas, emissions to water, lack of processes and compliance mechanisms to monitor compliance with UNGC principles and OECD Guidelines for Multinational Enterprises; for sovereigns: GHG Intensity and investee countries subject to social violations. In case of securities which finance specific projects contributing to environmental or social objectives equivalent data at project

Principal adverse impacts are the most significant negative impacts of investment decisions on sustainability factors relating to environmental, social and employee matters, respect for human rights, anti-corruption and anti-bribery matters.

level might be used to ensure that Sustainable Investments do not significantly harm any other environmental and/or social objective. The Investment Manager will strive to increase data coverage for PAI indicators with low data coverage by engaging with issuers and data providers. The Investment Manager will regularly evaluate whether the availability of data has increased sufficiently to potentially include assessment of such data in the investment process.

● *How are the sustainable investments aligned with the OECD Guidelines for Multinational Enterprises and the UN Guiding Principles on Business and Human Rights? Details:*

The Investment Manager's sustainable minimum exclusion list screens out companies based on their involvement in controversial practices against international norms. The core normative framework consists of the Principles of the UN Global Compact, the OECD Guidelines for Multinational Enterprises and the UN Guiding Principles for Business and Human Rights. Securities issued by companies having a severe violation of these frameworks will be restricted from the investment universe.

The EU Taxonomy sets out a "do not significant harm" principle by which Taxonomy-aligned investments should not significantly harm EU Taxonomy objectives and is accompanied by specific EU criteria.

The "do not significant harm" principle applies only to those investments underlying the financial product that take into account the EU criteria for environmentally sustainable economic activities. The investments underlying the remaining portion of this financial product do not take into account the EU criteria for environmentally sustainable economic activities.

Any other sustainable investments must also not significantly harm any environmental or social objectives.



Does this financial product consider principal adverse impacts on sustainability factors?

Yes

No

The Management Company has joined the Net Zero Asset Manager Initiative and considers PAI indicators through stewardship including engagement, both are relevant to mitigate potential adverse impact as a company.

Due to the commitment to the Net Zero Asset Manager Initiative, the Management Company aims to reduce greenhouse gas emissions in partnership with asset owner clients on decarbonisation goals, consistent with an ambition to reach net zero emission by 2050 or sooner across all assets under management. As part of this objective the Management Company will set an interim target for the proportion of assets to be managed in line with the attainment of net zero emissions by 2050 or sooner.

The Sub-Fund's Investment Manager addresses PAI indicators regarding greenhouse gas emission, biodiversity, water, waste as well as social and employee matters for corporate issuers, and, where relevant, the freedom house index is applied to investments in sovereigns. PAI indicators are considered within the Investment Manager's investment process through the means of exclusions as described in the "binding elements" section of the Sub-Fund.

The data coverage for the data required for the PAI indicators is heterogenous. The data coverage related to biodiversity, water and waste is low and the related PAI indicators are considered through exclusion of securities issued by companies having a severe violation / breach of principles and guidelines such as the Principles of the United Nations Global Compact, the OECD Guidelines for Multinational Enterprises, and the United Nations Guiding Principles for Business and Human Rights on the grounds of problematic practices around human rights, labour rights, environment, and corruption issues. Therefore, the Investment Manager will strive to increase data coverage for PAI indicators with low data coverage. The Investment Manager will regularly evaluate whether the availability of data has increased sufficiently to potentially include assessment of such data in the investment process.

Additionally, the Sub-Funds considers the GHG Intensity PAI indicator for sovereign issuers as sovereigns, which have not bindingly ratified the Paris Agreement, are not investable.

The following PAI indicators are considered:

Applicable to corporate issuers

- GHG Emissions
- Carbon footprint
- GHG Intensity of investee companies

- Exposure to companies active in the fossil fuel sector
- Activities negatively affecting biodiversity-sensitive areas
- Emissions to water
- Hazardous waste ratio
- Violation of UN Global compact principles
- Lack of processes and compliance mechanisms to monitor compliance with UN Global Compact principles
- Board gender diversity
- Exposure to controversial weapons

Applicable to sovereign and supranational issuers

- GHG Intensity
- Investee countries subject to social violations

The information on the PAI indicators will be available in the end-year report of the Sub-Fund.



The investment strategy guides investment decisions based on factors such as investment objectives and risk tolerance.

What investment strategy does this financial product follow?

Allianz Green Transition Bond's investment objective is to invest in Debt Securities of the Global Bond Markets with a focus on issuers (companies, sovereign and quasi-sovereign issuers) providing positive contribution to sustainable and environmental-friendly solutions and transition into a low-carbon economy in accordance with the Green Transition Strategy.

The Sub-Fund invests primarily:

- in Green Bonds financing climate change mitigation or adaptation projects or other environmental sustainability projects, notably in the following fields: energy efficiency, renewable energy, raw materials, water and land, waste management, greenhouse gas emissions reduction, biodiversity preservation or circular economy, and/or
- securities whose issuers explicitly commit to future improvements in sustainability outcomes within a predefined timeline included, but not limited to, securities from issuers participating to the SBT initiative, and/or
- in Debt Securities issued by sovereign issuers which have bindingly ratified the Paris Agreement, and which have a sufficient Freedom House Index score.

As far as the acquisition of Green Bonds is concerned, the Investment Manager analyses the projects financed by the Green Bond's proceeds. In order to be eligible, such projects have to be part of the green projects list as defined internally by Allianz Global Investors and based on research from the Climate Bonds Initiative (CBI), a world-class reputation organisation, which provides a science-based evaluation of the climate change mitigation impacts of the different types of projects.

The Investment Manager completes this analysis by also considering the Environment, Social, Governance, Human Rights and Business behaviour factors in the selection process of an issuer. The aforesaid sustainability factors are analysed through SRI Research by the Investment Manager in order to assess how sustainable development and long-term issues are taken into account in the strategy of an issuer. SRI Research means the overall process of identifying potential risks as well as potential opportunities of an investment in securities of an issuer related to the analysis of sustainability factors. SRI Research data combines external research data (which might have some limitations) with internal analyses. Based on a combination of the results of the external and/or internal analyses of the sustainability factors, an internal rating is derived monthly (SRI Rating) and is afterwards assigned to a corporate or sovereign issuer. In case the sustainability profile of the issuer is poor as measured by the average SRI Rating, the bonds issued by or from this issuer would not be eligible.

The last step of the Investment Manager's analysis is focused on the credibility of the respective issuer's approach regarding its individual transition approach to reach to a low carbon model. The Investment Manager's intention is to favour Green Bonds from such issuers which have set up a sound and understandable strategy to mitigate the negative environmental impacts of respective issuers' activities. The Investment Manager tries to identify such issuers which only make use of the Green Bond market solely for communication / marketing purposes and will therefore not invest in bonds issued by such issuers. As far as the securities issued by companies participating to the SBT initiative, are concerned, the Investment Manager considers issuers' commitments to future improvements in sustainability outcomes by analysing companies' ambitions to reduce

emissions in line with the Paris Agreement goals. Issuers taking part to the SBT initiative commit defined targets to reduce greenhouse gas (GHG) emissions in line with the agreement as of April 2016 within the United Nations Framework Convention on Climate Change (UNFCCC), on climate change mitigation, adaptation, and finance (the "Paris Agreement"). In addition, Debt securities are only eligible if their issuers have set targets which are annually published and monitored. Debt Securities whose issuers participate in the SBT initiative shall be evaluated by an SRI Rating. The proportion of assets which do not have an SRI Rating is expected to be low.

Examples of instruments not attaining to the SRI Rating are cash and deposits, some Target Funds, and investments with temporarily divergent or absent environmental, social, or good governance qualifications.

The Sub-Fund's general investment approach used to achieve the Sub-Fund's investment objective (Sub-Fund's applicable General Asset Class Principles in combination with its individual investment restrictions) is described in the prospectus.

● **What are the binding elements of the investment strategy used to select the investments to attain each of the environmental or social characteristics promoted by this financial product?**

The Sub-Fund adheres to the following binding elements to ensure attainment of the environmental or social characteristics:

- Min. 80% of the Sub-Fund's assets are invested in Debt Securities in accordance with the Green Transition Strategy which includes green bonds; issuers explicitly committing to future improvements in sustainability outcomes with a predefined timeline, including but not limited to issuers participating in the SBTi; as well as Sovereign issuers which have bindingly ratified the Paris Agreement, and which have a sufficient Freedom House Index score.
- Green Bonds and SBTi issuers held in the portfolio are adhering to the minimum SRI rating threshold of 1 (out of a rating scale from 0 – 4; 0 being the worst rating and 4 the best rating).
- Application of the below sustainable minimum exclusion criteria and Sub-Fund specific minimum exclusion criteria:

The following sustainable minimum exclusion criteria for direct investments apply:

- securities issued by companies having a severe violation / breach of principles and guidelines such as the Principles of the United Nations Global Compact, the OECD Guidelines for Multinational Enterprises, and the United Nations Guiding Principles for Business and Human Rights on the grounds of problematic practices around human rights, labour rights, environment, and corruption issues,
- securities issued by companies involved in controversial weapons (anti-personnel mines, cluster munitions, chemical weapons, biological weapons, depleted uranium, white phosphorus, and nuclear weapons),
- securities issued by companies that derive more than 10% of their revenues from weapons, military equipment, and services,
- securities issued by companies that derive more than 10% of their revenue from thermal coal extraction,
- securities issued by utility companies that generate more than 20% of their revenues from coal,
- securities issued by companies involved in the production of tobacco, and securities issued by companies involved in the distribution of tobacco with more than 5% of their revenues.

The following Sub-Fund specific exclusion criteria for direct investments apply:

- Sovereign issuers qualified with a score as "Not Free" by the Freedom House Index
- Sovereign issuers that have not ratified the Paris agreement

The minimum exclusion criteria, as well as the Sub-Fund specific exclusion criteria, are based on information from an external data provider and coded in pre- and post-trade compliance. The review is performed at least half yearly.

● **What is the committed minimum rate to reduce the scope of the investments considered prior to the application of that investment strategy?**

The Sub-Fund does not commit to reduce the scope of the investments by a certain minimum rate.

Good governance practices include sound management structures, employee relations, remuneration of staff and tax compliance.

● **What is the policy to assess good governance practices of the investee companies?**

Good governance principles are considered by screening out companies based on their involvement in controversies around international norms corresponding to the four good governance practices: sound management structures, employee relations, remuneration of staff and tax compliance. Companies having a severe violation in either of those areas will not be investible. For certain cases, flagged issuers shall be on a watch list. These companies will appear on this watch list when the Investment Manager believes that engagement may lead to improvements or when the company is assessed to take remedial actions. Companies on the watch list remain investible unless the Investment Manager believes that the engagement or the remedial actions of the company does not lead to the desired remedy of the severe controversy.

In addition, the Sub-Fund's Investment Manager is committed to actively encourage open dialogues with investee companies on corporate governance, proxy voting and broader sustainability issues in advance of shareholder meetings (regularly for direct investments in shares). The Sub-Fund's Investment Manager's approach to proxy voting and company engagement is set out in the Management Company's Stewardship Statement.



Asset allocation describes the share of investments in specific assets.

What is the asset allocation planned for this financial product?

Min. 80% of the Sub-Funds' assets are used to meet the environmental or social characteristics promoted by this Sub-Fund. A low portion of the Sub-Fund might contain assets which do not promote environmental or social characteristics. Example of such instruments are derivatives, cash and deposits, some Target Funds and investment with temporarily divergent or absent environmental, social, or good governance qualifications or investments outside of the specified quota to be invested as part of the Green Transition Strategy. Min. 20% of the Sub-Funds' assets will be invested in Sustainable Investments. The minimum percentage of investments that are aligned with the EU Taxonomy is 0.01%. The Sub-Fund's Investment Manager does not commit to a minimum share of environmentally Sustainable Investments that are not aligned with the EU Taxonomy. The Sub-Fund's Investment Manager does not commit to a minimum share of socially sustainable investments. While the Sub-Fund cannot commit to a minimum share of environmentally or socially sustainable investments, such investments may be freely allocated to within the Sub-Fund aggregated sustainable investment commitment disclosed (min. 20%).

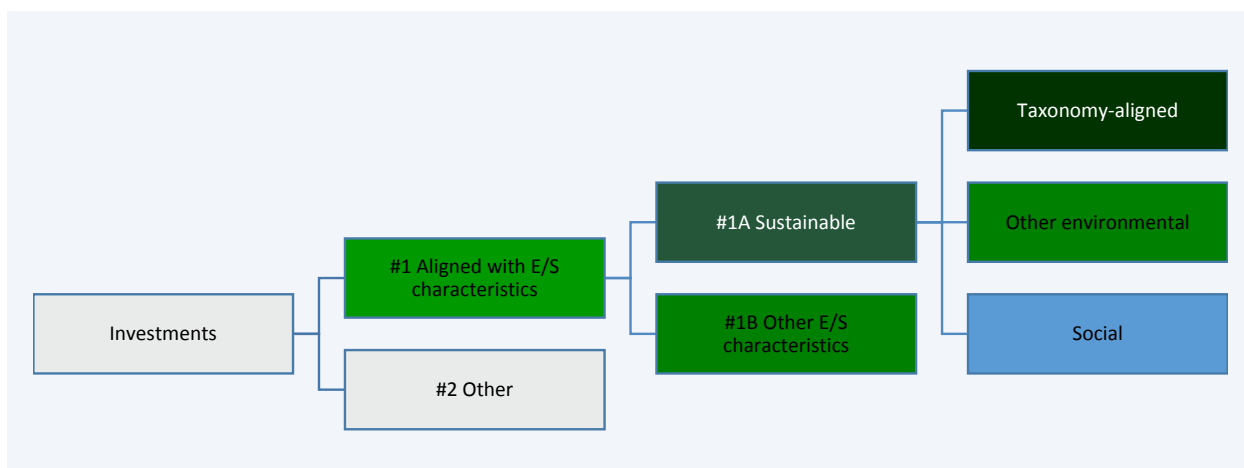

#1 Aligned with E/S characteristics includes the investments of the financial product used to attain the environmental or social characteristics promoted by the financial product.

#2 Other includes the remaining investments of the financial product which are neither aligned with the environmental or social characteristics, nor are qualified as sustainable investments.

The category **#1 Aligned with E/S characteristics** covers:

- The sub-category **#1A Sustainable** covers sustainable investments with environmental or social objectives.
- The sub-category **#1B Other E/S characteristics** covers investments aligned with the environmental or social characteristics that do not qualify as sustainable investments.

● **How does the use of derivatives attain the environmental or social characteristics promoted by the financial product?**

Not applicable



To what minimum extent are sustainable investments with an environmental objective aligned with the EU Taxonomy?

The Taxonomy-aligned investments include debt and/or equity in environmentally sustainable economic activities aligned with the EU-Taxonomy. The minimum percentage of investments that are aligned with the EU Taxonomy is 0.01%. Taxonomy-aligned data is provided by an external data provider. The Investment Manager has assessed the quality of such data. The data will not be subject to an assurance provided by auditors or a review by third parties. The data will not reflect any data in government bonds. As of today, there is no recognized methodology available to determine the proportion of Taxonomy-aligned activities when investing in government bonds.

Taxonomy-aligned activities in this disclosure are based on share of turnover. Pre-contractual figures use turnover as its financial metric as a default in line with the regulatory requirements and based on the fact that complete, verifiable or up-to date data for CAPEX and/or OPEX as financial metric is even less available.

Taxonomy-aligned data is only in rare cases data reported by companies in accordance with the EU Taxonomy. The data provider has derived Taxonomy-aligned data from other available equivalent public data.

● Does the financial product invest in fossil gas and/or nuclear energy related activities that comply with the EU Taxonomy ¹?

- Yes:
- In fossil gas In nuclear energy
- No

The Sub-Fund does not pursue any investments in fossil gas and/or nuclear energy related activities that comply with the EU Taxonomy. Nevertheless, as result of this investment strategy, investments may occur in corporates which are also active in these activities. Further information will be provided as part of the annual reporting, if relevant.

The two graphs below show in green the minimum percentage of investments that are aligned with the EU Taxonomy. As there is no appropriate methodology to determine the Taxonomy-alignment of sovereign bonds^{*}, the first graph shows the Taxonomy-alignment in relation to all the investments of the financial product including sovereign bonds, while the second graph shows the Taxonomy-alignment only in relation to the investments of the financial product other than sovereign bonds.

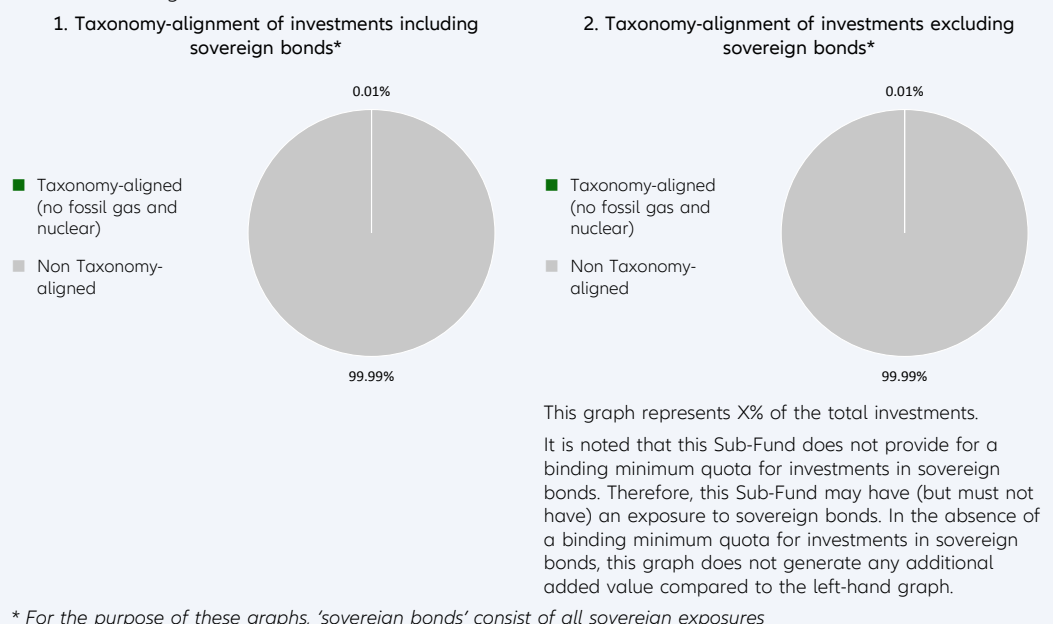

Taxonomy-aligned activities are expressed as a share of:

- **turnover** reflecting the share of revenue from green activities of investee companies
- **capital expenditure** (CapEx) showing the green investments made by investee companies, e.g. for a transition to a green economy.
- **operational expenditure** (OpEx) reflecting green operational activities of investee companies.

¹ Fossil gas and/or nuclear related activities will only comply with the EU Taxonomy where they contribute to limiting climate change ("climate change mitigation") and do not significantly harm any EU Taxonomy objective - see explanatory note in the left hand margin. The full criteria for fossil gas and nuclear energy economic activities that comply with the EU Taxonomy are laid down in Commission Delegated Regulation (EU) 2022/1214.

Enabling activities directly enable other activities to make a substantial contribution to an environmental objective.

Transitional activities are activities for which low-carbon alternatives are not yet available and among others have greenhouse gas emission levels corresponding to the best performance.

- **What is the minimum share of investments in transitional and enabling activities?**
The Sub-Fund’s Investment Manager does not commit to a split of minimum taxonomy alignment into transitional, enabling activities and own performance.



What is the minimum share of sustainable investments with an environmental objective that are not aligned with the EU Taxonomy?

Taxonomy-aligned investments are considered a sub-category of Sustainable Investments. If an investment is not Taxonomy-aligned since the activity is not yet covered under the EU Taxonomy or the positive contribution is not substantial enough to comply with the Taxonomy technical screening criteria, the investment can still be considered an environmentally Sustainable Investment provided it complies with all criteria. The Investment Manager does not commit to a minimum share of environmentally Sustainable Investments that are not aligned with the EU Taxonomy. The overall sustainable investment share may also include investments with an environmental objective in economic activities that do not qualify as environmentally sustainable under the EU Taxonomy, and while the Sub-Fund cannot commit to a minimum share of environmentally or socially sustainable investments, such investments may be freely allocated to within the Sub-Fund aggregated sustainable investment commitment disclosed (min. 20%).



are sustainable investments with an environmental objective that **do not take into account the criteria** for environmentally sustainable economic activities under the EU Taxonomy.



What is the minimum share of socially sustainable investments?

The Investment Manager defines Sustainable Investments based on internal research, which uses, among others, the UN Sustainable Development Goals (SDGs), as well as the objectives of the EU Taxonomy as reference frameworks. The Investment Manager does not commit to a minimum share of socially Sustainable Investments, as the SDGs contain environmental as well as social objectives. The overall sustainable investment share may also include investments with a social objective, and while the Sub-Fund cannot commit to a minimum share of environmentally or socially sustainable investments, such investments may be freely allocated to within the Sub-Fund aggregated sustainable investment commitment disclosed (min. 20%).



What investments are included under “#2 Other”, what is their purpose and are there any minimum environmental or social safeguards?

Under “#2 Other” investments into cash, Target Funds, or derivatives can be included. Derivatives might be used for efficient portfolio management (including risk hedging) and/or investment purposes, and Target Funds to benefit from a specific strategy. For those investments no environmental or social safeguards are applied.



Is a specific index designated as a reference benchmark to determine whether this financial product is aligned with the environmental and/or social characteristics that it promotes?

Yes, the Sub-Fund has assigned 1/3 BLOOMBERG MSCI Global Green Bond Total Return (hedged into USD) + 1/3 BLOOMBERG MSCI Global Corporate Sustainability Total Return (hedged into USD) + 1/3 J.P. MORGAN ESG Emerging Market Bond (EMBI) Global Diversified as composite benchmark.

Reference benchmarks are indexes to measure whether the financial product attains the environmental or social characteristics that they promote.

- **How is the reference benchmark continuously aligned with each of the environmental or social characteristics promoted by the financial product?**

The Sub-Fund uses a composite benchmark with 3 different methodologies:

BLOOMBERG MSCI Global Green Bond Total Return: The benchmark measures the global market for fixed income securities issued to fund projects with direct environmental benefits. The methodology evaluates index-eligible green bonds to ensure they adhere to established Green Bond Principles and to classify bonds by their environmental use of proceeds.

BLOOMBERG MSCI Global Corporate Sustainability Total Return: The benchmark uses ESG criteria that include corporate fixed-rate bonds from both developed and emerging markets issuers with strong positive environmental, social and governance (ESG) ratings [issuers with a ESG Rating greater than or equal to BBB and a ESG Controversy Score greater than 0].

J.P. MORGAN ESG Emerging Market Bond (EMBI) Global Diversified: The Benchmark applies an ESG scoring and screening methodology to tilt toward issuers ranked higher on ESG criteria and green bond, and to underweight and remove issuers that rank lower.

Those benchmarks are not completely aligned with the environmental and social characteristics promoted by the Sub-Fund as specific screening and exclusion criteria might deviate.

- **How is the alignment of the investment strategy with the methodology of the index ensured on a continuous basis?**

The composite benchmark is not continuously aligned as the screening and exclusion criteria of the benchmark deviate from the Sub-Fund's investment strategy.

- **How does the designated index differ from a relevant broad market index?**

Those benchmarks use either ESG criteria for index construction or focus on green bonds.

- **Where can the methodology used for the calculation of the designated index be found?**

Details of the Benchmarks' methodology may be found at <https://www.msci.com/our-solutions/indexes/bloomberg-msci-esg-fixed-income-indexes> or www.msci.com and <https://www.jpmorgan.com/content/dam/jpm/cib/complex/content/markets/composition-docs/pdf-30.pdf> or www.jpmorgan.com



Where can I find more product specific information online?

More product-specific information can be found on the website: <https://regulatory.allianzgi.com/SFDR>

Template pre-contractual disclosure for the financial products referred to in Article 8, paragraphs 1, 2 and 2a, of Regulation (EU) 2019/2088 and Article 6, first paragraph, of Regulation (EU) 2020/852

Product name:

Allianz High Dividend Asia Pacific Equity

Legal entity identifier: 549300NMGJFNXMUMPO08

Environmental and/or social characteristics

Sustainable investment means an investment in an economic activity that contributes to an environmental or social objective, provided that the investment does not significantly harm any environmental or social objective and that the investee companies follow good governance practices.

The EU Taxonomy is a classification system laid down in Regulation (EU) 2020/852, establishing a list of environmentally sustainable economic activities. That Regulation does not include a list of socially sustainable economic activities. Sustainable investments with an environmental objective might be aligned with the Taxonomy or not.

Does this financial product have a sustainable investment objective?	
Yes	No
<input type="checkbox"/> It will make a minimum of sustainable investments with an environmental objective: ___% <input type="checkbox"/> in economic activities that qualify as environmentally sustainable under the EU Taxonomy <input type="checkbox"/> in economic activities that do not qualify as environmentally sustainable under the EU Taxonomy	<input checked="" type="checkbox"/> It promotes Environmental/Social (E/S) characteristics and while it does not have as its objective a sustainable investment, it will have a minimum proportion of 2.00% of sustainable investments <input checked="" type="checkbox"/> with an environmental objective in economic activities that qualify as environmentally sustainable under the EU Taxonomy <input checked="" type="checkbox"/> with an environmental objective in economic activities that do not qualify as environmentally sustainable under the EU Taxonomy <input checked="" type="checkbox"/> with a social objective
<input type="checkbox"/> It will make a minimum of sustainable investments with a social objective ___%	<input type="checkbox"/> It promotes E/S characteristics, but will not make any sustainable investments



What environmental and/or social characteristics are promoted by this financial product?

Allianz High Dividend Asia Pacific Equity (the "Sub-Fund") is managed according to the Sustainability Key Performance Indicator Strategy (Relative) ("KPI Strategy (Relative)") which addresses greenhouse gas (GHG) Intensity. The "Sustainability KPI" measures the GHG Intensity defined by the weighted average intensity of greenhouse gas emissions based on company's annual sales ("GHG Intensity").

GHG Intensity will be addressed by outperforming the Weighted Average GHG Intensity against its benchmark.

In addition, sustainable minimum exclusion criteria apply.

A reference benchmark has been designated for the purpose of attaining the environmental and/or social characteristics promoted by the Sub-Fund.

What sustainability indicators are used to measure the attainment of each of the environmental or social characteristics promoted by this financial product?

To measure the attainment of the environmental and/or social characteristics the following sustainability indicators are used and reported on, at the fiscal year end:

- The actual percentage of KPI coverage of the Sub-Fund's Portfolio (Portfolio in this respect does not comprise derivatives and instruments that are non-evaluated by nature (e. g., cash and deposits)).
- The actual weighted average GHG Intensity portfolio vs weighted average GHG Intensity of the benchmark.

Sustainability indicators measure how the environmental or social characteristics promoted by the financial product are attained.

- Confirmation that Principal adverse impacts (PAIs) of investment decisions on sustainability factors are considered through the application of exclusion criteria.
- **What are the objectives of the sustainable investments that the financial product partially intends to make and how does the sustainable investment contribute to such objectives?**

Sustainable investments contribute to environmental and/or social objectives, for which the Investment Manager uses as reference frameworks, among others, the UN Sustainable Development Goals (SDGs), as well as the objectives of the EU Taxonomy:

1. Climate Change Mitigation
2. Climate Change Adaptation
3. Sustainable Use and Protection of Water and Marine Resources
4. Transition to a Circular Economy
5. Pollution Prevention and Control
6. Protection and Restoration of Biodiversity and Ecosystems

The assessment of the positive contribution to the environmental or social objectives is based on a proprietary framework which combines quantitative elements with qualitative inputs from internal research. The methodology applies first a quantitative breakdown of a securities issuer into its business activities. The qualitative element of the framework is an assessment if business activities contribute positively to an environmental or a social objective.

To calculate the positive contribution on the Sub-Fund level the revenue share of each issuer attributable to business activities contributing to environmental and/or social objectives is considered provided the issuer is satisfying the Do No Significant Harm (“DNSH”) and Good Governance principles, and an asset-weighted aggregation is performed as a second step. Moreover, for certain types of securities, which finance specific projects contributing to environmental or social objectives the overall investment is considered to contribute to environmental and/or social objectives, but also for these a DNSH as well as a Good Governance check for issuers is performed.

- **How do the sustainable investments that the financial product partially intends to make, not cause significant harm to any environmental or social sustainable investment objective?**

In order to ensure that Sustainable Investments do not significantly harm any other environmental and/or social objective, the Investment Manager is leveraging the PAI indicators, whereby significance thresholds have been defined to identify significantly harmful issuers. Issuers not meeting the significance threshold can be engaged for a limited time period to remediate the adverse impact. Otherwise, if the issuer does not meet the defined significance thresholds twice subsequently or in case of a failed engagement, it does not pass the DNSH assessment. Investments in securities of issuers which do not pass the DNSH assessment are not counted as sustainable investments.

- *How have the indicators for adverse impacts on sustainability factors been taken into account?*

All mandatory PAI indicators are considered either as part of the application of the exclusion criteria or through thresholds on a sectorial or absolute basis. Significance thresholds have been defined and they refer to qualitative or quantitative criteria.

Recognizing the lack of data coverage for some of the PAI indicators equivalent data points are used to assess PAI indicators when applying the DNSH assessment, when relevant, for the following indicators for corporates: share of non-renewable energy consumption and production, activities negatively affecting biodiversity-sensitive areas, emissions to water, lack of processes and compliance mechanisms to monitor compliance with UNGC principles and OECD Guidelines for Multinational Enterprises; for sovereigns: GHG Intensity and investee countries subject to social violations. In case of securities which finance specific projects contributing to environmental or social objectives equivalent data at project level might be used to ensure that Sustainable Investments do not significantly harm any other environmental and/or social objective. The Investment Manager will strive to increase data coverage for PAI indicators with low data coverage by engaging with issuers and data providers. The Investment Manager will regularly evaluate whether the availability of data has increased sufficiently to potentially include assessment of such data in the investment process.

Principal adverse impacts are the most significant negative impacts of investment decisions on sustainability factors relating to environmental, social and employee matters, respect for human rights, anti-corruption and anti-bribery matters.

- *How are the sustainable investments aligned with the OECD Guidelines for Multinational Enterprises and the UN Guiding Principles on Business and Human Rights? Details:*

The Investment Manager's sustainable minimum exclusion list screens out companies based on their involvement in controversial practices against international norms. The core normative framework consists of the Principles of the UN Global Compact, the OECD Guidelines for Multinational Enterprises and the UN Guiding Principles for Business and Human Rights. Securities issued by companies having a severe violation of these frameworks will be restricted from the investment universe.

The EU Taxonomy sets out a "do not significant harm" principle by which Taxonomy-aligned investments should not significantly harm EU Taxonomy objectives and is accompanied by specific EU criteria.

The "do not significant harm" principle applies only to those investments underlying the financial product that take into account the EU criteria for environmentally sustainable economic activities. The investments underlying the remaining portion of this financial product do not take into account the EU criteria for environmentally sustainable economic activities.

Any other sustainable investments must also not significantly harm any environmental or social objectives.



Does this financial product consider principal adverse impacts on sustainability factors?

Yes

No

The Management Company has joined the Net Zero Asset Manager Initiative and considers PAI indicators through stewardship including engagement, both are relevant to mitigate potential adverse impact as a company.

Due to the commitment to the Net Zero Asset Manager Initiative, the Management Company aims to reduce greenhouse gas emissions in partnership with asset owner clients on decarbonisation goals, consistent with an ambition to reach net zero emission by 2050 or sooner across all assets under management. As part of this objective the Management Company will set an interim target for the proportion of assets to be managed in line with the attainment of net zero emissions by 2050 or sooner.

The Sub-Fund's Investment Manager addresses PAI indicators regarding greenhouse gas emission, biodiversity, water, waste as well as social and employee matters for corporate issuers, and, where relevant, the freedom house index is applied to investments in sovereigns. PAI indicators are considered within the Investment Manager's investment process through the means of exclusions as described in the "binding elements" section of the Sub-Fund.

The data coverage for the data required for the PAI indicators is heterogenous. The data coverage related to biodiversity, water and waste is low and the related PAI indicators are considered through exclusion of securities issued by companies having a severe violation / breach of principles and guidelines such as the Principles of the United Nations Global Compact, the OECD Guidelines for Multinational Enterprises, and the United Nations Guiding Principles for Business and Human Rights on the grounds of problematic practices around human rights, labour rights, environment, and corruption issues. Therefore, the Investment Manager will strive to increase data coverage for PAI indicators with low data coverage. The Investment Manager will regularly evaluate whether the availability of data has increased sufficiently to potentially include assessment of such data in the investment process.

Additionally, the Investment manager considers GHG related PAI indicators by outperforming the Weighted Average GHG Intensity against its benchmark.

The following PAI indicators are considered:

Applicable to corporate issuers

- GHG Emissions
- Carbon footprint
- GHG Intensity of investee companies
- Exposure to companies active in the fossil fuel sector
- Activities negatively affecting biodiversity-sensitive areas
- Emissions to water
- Hazardous waste ratio

- Violation of UN Global compact principles
- Lack of processes and compliance mechanisms to monitor compliance with UN Global Compact principles
- Board gender diversity
- Exposure to controversial weapons

Applicable to sovereign and supranational issuers

- Investee countries subject to social violations

The information on the PAI indicators will be available in the end-year report of the Sub-Fund.



What investment strategy does this financial product follow?

The investment strategy guides investment decisions based on factors such as investment objectives and risk tolerance.

Allianz High Dividend Asia Pacific Equity's investment objective is to invest in a portfolio of Asia Pacific (excluding Japan) equity market securities, with a potential dividend yield above the market average in accordance with the Sustainability Key Performance Indicator Strategy (Relative) ("KPI Strategy (Relative)").

The Sub-Fund's strategy is to outperform the Weighted Average GHG Intensity against its benchmark. The outperformance is determined as the excess between the Sub-Fund's weighted average GHG Intensity and the Sub-Fund's benchmark Weighted Average GHG Intensity.

The weighted average GHG Intensity is the weighted average of the Sub-Fund's GHG Intensity (in tCO₂e per Millions of sales). Sales represent company's annual sales. This ratio of GHG normalized by Sales facilitates comparison between companies of different sizes. The ratio is in tCO₂e per Millions of sales. The metric allows comparing weighted average GHG Intensities of different portfolios to identify portfolios comprised of more GHG-efficient issuers in terms of the issuer's sales. The portfolio weights (and benchmark or universe weights) are rebased such that only issuers with GHG emissions data available are considered in the calculation. GHG represents a respective issuer's greenhouse gas emissions. To determine the GHG Intensity of a company issuer, GHG Intensity data from third party data providers will be used. The GHG intensity is analysed by the Investment Manager and is considered within the securities selection process in order to meet the Sub-Fund Investment objective.

The proportion of assets which do not have a GHG intensity assessment is expected to be low. Examples of instruments not having a GHG intensity assessment are cash and deposits, some Target Funds, and investments for which the GHG intensity is deemed to be not appropriate and/or data is not available.

The Sub-Fund's general investment approach (Sub-Fund's applicable General Asset Class Principles in combination with its individual investment restrictions) is described in the prospectus.

● What are the binding elements of the investment strategy used to select the investments to attain each of the environmental or social characteristics promoted by this financial product?

The binding elements are:

- Min. 80% KPI coverage of the Sub-Fund's Portfolio (Portfolio in this respect does not comprise derivatives and instruments that are non-evaluated by nature (e. g., cash and deposits)).
- Min. 20% outperformance of benchmark in terms of Weighted Average GHG Intensity.
- Application of the following sustainable minimum exclusion criteria for direct investments:
 - securities issued by companies having a severe violation / breach of principles and guidelines such as the Principles of the United Nations Global Compact, the OECD Guidelines for Multinational Enterprises, and the United Nations Guiding Principles for Business and Human Rights on the grounds of problematic practices around human rights, labour rights, environment, and corruption issues,
 - securities issued by companies involved in controversial weapons (anti-personnel mines, cluster munitions, chemical weapons, biological weapons, depleted uranium, white phosphorus, and nuclear weapons),
 - securities issued by companies that derive more than 10% of their revenues from weapons, military equipment, and services,
 - securities issued by companies that derive more than 10% of their revenue from thermal coal extraction,
 - securities issued by utility companies that generate more than 20% of their revenues from coal,

- securities issued by companies involved in the production of tobacco, and securities issued by companies involved in the distribution of tobacco with more than 5% of their revenues.

Direct investments in sovereign issuers with an insufficient freedom house index score are excluded.

The sustainable minimum exclusion criteria are based on information from an external data provider and coded in pre- and post-trade compliance. The review is performed at least half yearly.

- **What is the committed minimum rate to reduce the scope of the investments considered prior to the application of that investment strategy?**

The Sub-Fund does not commit to reduce the scope of the investments by a certain minimum rate.

- **What is the policy to assess good governance practices of the investee companies?**

Good governance principles are considered by screening out companies based on their involvement in controversies around international norms corresponding to the four good governance practices: sound management structures, employee relations, remuneration of staff and tax compliance. Companies having a severe violation in either of those areas will not be investible. For certain cases, flagged issuers shall be on a watch list. These companies will appear on this watch list when the Investment Manager believes that engagement may lead to improvements or when the company is assessed to take remedial actions. Companies on the watch list remain investible unless the Investment Manager believes that the engagement or the remedial actions of the company does not lead to the desired remedy of the severe controversy.

In addition, the Sub-Fund's Investment Manager is committed to actively encourage open dialogues with investee companies on corporate governance, proxy voting and broader sustainability issues in advance of shareholder meetings (regularly for direct investments in shares). The Sub-Fund's Investment Manager's approach to proxy voting and company engagement is set out in the Management Company's Stewardship Statement.

Good governance practices include sound management structures, employee relations, remuneration of staff and tax compliance.



What is the asset allocation planned for this financial product?

Asset allocation describes the share of investments in specific assets.

Min. 80% of the Sub-Funds' assets (excluding cash, and derivatives) are used to meet the environmental or social characteristics promoted by this Sub-Fund. A low portion of the Sub-Fund might contain assets which do not promote environmental or social characteristics. Examples of such instruments are derivatives, cash and deposits, some Target Funds and investment with temporarily divergent or absent environmental, social, or good governance qualifications. Min. 2% of the Sub-Funds' assets will be invested in Sustainable Investments. The Sub-Fund's Investment Manager does not commit to a minimum share of sustainable investments with an environmental objective aligned with the EU Taxonomy nor to a minimum share of environmentally Sustainable Investments that are not aligned with the EU Taxonomy. The Sub-Fund's Investment Manager does not commit to a minimum share of socially sustainable investments. While the Sub-Fund cannot commit to a minimum share of environmentally or socially sustainable investments, such investments may be freely allocated to within the Sub-Fund aggregated sustainable investment commitment disclosed (min. 2%).

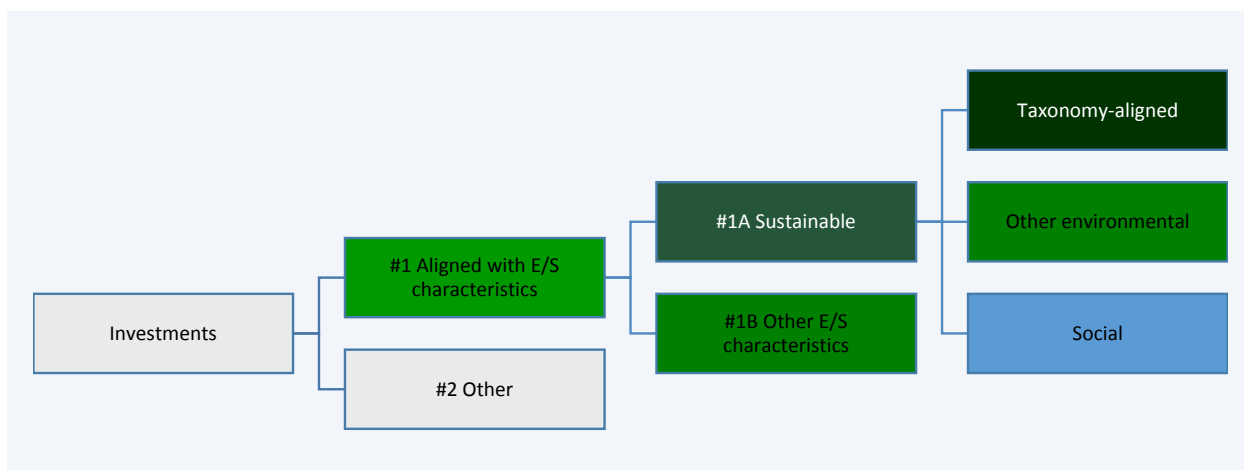

#1 Aligned with E/S characteristics includes the investments of the financial product used to attain the environmental or social characteristics promoted by the financial product.

#2 Other includes the remaining investments of the financial product which are neither aligned with the environmental or social characteristics, nor are qualified as sustainable investments.

The category #1 Aligned with E/S characteristics covers:

- The sub-category #1A Sustainable covers sustainable investments with environmental or social objectives.
- The sub-category #1B Other E/S characteristics covers investments aligned with the environmental or social characteristics that do not qualify as sustainable investments.

● How does the use of derivatives attain the environmental or social characteristics promoted by the financial product?

Not applicable



To what minimum extent are sustainable investments with an environmental objective aligned with the EU Taxonomy?

The Sub-Fund’s Investment Manager does not commit to a minimum share of sustainable investments with an environmental objective aligned with the EU Taxonomy. The overall sustainable investment share may also include investments with an environmental objective in economic activities that qualify as environmentally sustainable under the EU Taxonomy.

● Does the financial product invest in fossil gas and/or nuclear energy related activities that comply with the EU Taxonomy ¹?

- Yes:
 - In fossil gas
 - In nuclear energy
- No

The Sub-Fund does not pursue any investments in fossil gas and/or nuclear energy related activities that comply with the EU Taxonomy. Nevertheless, as result of this investment strategy, investments may occur in corporates which are also active in these activities. Further information will be provided as part of the annual reporting, if relevant.

The two graphs below show in green the minimum percentage of investments that are aligned with the EU Taxonomy. As there is no appropriate methodology to determine the Taxonomy-alignment of sovereign bonds*, the first graph shows the Taxonomy-alignment in relation to all the investments of the financial product including sovereign bonds, while the second graph shows the Taxonomy-alignment only in relation to the investments of the financial product other than sovereign bonds.

1. Taxonomy-alignment of investments including sovereign bonds*

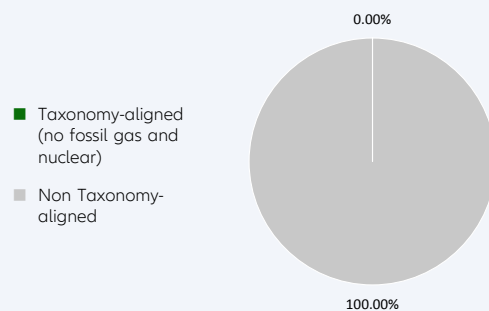

2. Taxonomy-alignment of investments excluding sovereign bonds*

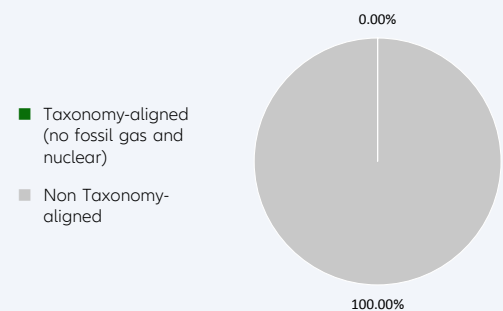

This graph represents X% of the total investments. It is noted that – due to the fact that this Sub-Fund does not provide for a minimum quota of taxonomy-aligned investments – this graph does not generate any additional added value compared to the left-hand graph.

* For the purpose of these graphs, 'sovereign bonds' consist of all sovereign exposures

● What is the minimum share of investments in transitional and enabling activities?

The Sub-Fund’s Investment Manager does not commit to a split of minimum taxonomy alignment into transitional, enabling activities and own performance.

Taxonomy-aligned activities are expressed as a share of:
 - turnover reflecting the share of revenue from green activities of investee companies
 - capital expenditure (CapEx) showing the green investments made by investee companies, e.g. for a transition to a green economy.
 - operational expenditure (OpEx) reflecting green operational activities of investee companies.

Enabling activities directly enable other activities to make a substantial contribution

¹ Fossil gas and/or nuclear related activities will only comply with the EU Taxonomy where they contribute to limiting climate change ("climate change mitigation") and do not significantly harm any EU Taxonomy objective - see explanatory note in the left hand margin. The full criteria for fossil gas and nuclear energy economic activities that comply with the EU Taxonomy are laid down in Commission Delegated Regulation (EU) 2022/1214.

to an environmental objective.

Transitional activities are activities for which low-carbon alternatives are not yet available and among others have greenhouse gas emission levels corresponding to the best performance.



What is the minimum share of sustainable investments with an environmental objective that are not aligned with the EU Taxonomy?

Taxonomy-aligned investments are considered a sub-category of Sustainable Investments. If an investment is not Taxonomy-aligned since the activity is not yet covered under the EU Taxonomy or the positive contribution is not substantial enough to comply with the Taxonomy technical screening criteria, the investment can still be considered an environmentally Sustainable Investment provided it complies with all criteria. The Investment Manager does not commit to a minimum share of environmentally Sustainable Investments that are not aligned with the EU Taxonomy. The overall sustainable investment share may also include investments with an environmental objective in economic activities that do not qualify as environmentally sustainable under the EU Taxonomy, and while the Sub-Fund cannot commit to a minimum share of environmentally or socially sustainable investments, such investments may be freely allocated to within the Sub-Fund aggregated sustainable investment commitment disclosed (min. 2%).



are sustainable investments with an environmental objective that **do not take into account the criteria** for environmentally sustainable economic activities under the EU Taxonomy.



What is the minimum share of socially sustainable investments?

The Investment Manager defines Sustainable Investments based on internal research, which uses, among others, the UN Sustainable Development Goals (SDGs), as well as the objectives of the EU Taxonomy as reference frameworks. The Investment Manager does not commit to a minimum share of socially Sustainable Investments, as the SDGs contain environmental as well as social objectives. The overall sustainable investment share may also include investments with a social objective, and while the Sub-Fund cannot commit to a minimum share of environmentally or socially sustainable investments, such investments may be freely allocated to within the Sub-Fund aggregated sustainable investment commitment disclosed (min 2%).



What investments are included under “#2 Other”, what is their purpose and are there any minimum environmental or social safeguards?

Under “#2 Other” investments into cash, Target Funds, or derivatives can be included. Derivatives might be used for efficient portfolio management (including risk hedging) and/or investment purposes, and Target Funds to benefit from a specific strategy. For those investments no environmental or social safeguards are applied.



Is a specific index designated as a reference benchmark to determine whether this financial product is aligned with the environmental and/or social characteristics that it promotes?

Yes, the Sub-Fund has assigned the MSCI AC Asia Pacific Excl. Japan Total Return Net as a benchmark. This benchmark is a market index. The Sub-Fund will promote environmental and social characteristics by outperforming the benchmark's Weighted Average GHG Intensity

Reference benchmarks are indexes to measure whether the financial product attains the environmental or social

- **How is the reference benchmark continuously aligned with each of the environmental or social characteristics promoted by the financial product?**

The benchmark is a market index and does not incorporate environmental or social characteristics for index construction.

characteristics that they promote.

- **How is the alignment of the investment strategy with the methodology of the index ensured on a continuous basis?**

The benchmark is not continuously aligned as it does not incorporate environmental or social characteristics for index construction.

- **How does the designated index differ from a relevant broad market index?**

The benchmark is a broad market index.

- **Where can the methodology used for the calculation of the designated index be found?**

Details of the Benchmark's methodology may be found at <https://www.msci.com/documents/10199/0df2ed3c-5fea-4414-b875-55dcd31705ad> or at www.msci.com



Where can I find more product specific information online?

More product-specific information can be found on the website: <https://regulatory.allianzgi.com/SFDR>

Template pre-contractual disclosure for the financial products referred to in Article 8, paragraphs 1, 2 and 2a, of Regulation (EU) 2019/2088 and Article 6, first paragraph, of Regulation (EU) 2020/852

Product name:

Allianz Japan Equity

Legal entity identifier: 529900D7K4CJB8ABAW87

Environmental and/or social characteristics

Sustainable investment means an investment in an economic activity that contributes to an environmental or social objective, provided that the investment does not significantly harm any environmental or social objective and that the investee companies follow good governance practices.

The EU Taxonomy is a classification system laid down in Regulation (EU) 2020/852, establishing a list of **environmentally sustainable economic activities**. That Regulation does not include a list of socially sustainable economic activities. Sustainable investments with an environmental objective might be aligned with the Taxonomy or not.

Does this financial product have a sustainable investment objective?	
<input checked="" type="radio"/> <input checked="" type="radio"/> Yes	<input checked="" type="radio"/> <input type="radio"/> No
<input type="checkbox"/> It will make a minimum of sustainable investments with an environmental objective : ____% <input type="checkbox"/> in economic activities that qualify as environmentally sustainable under the EU Taxonomy <input type="checkbox"/> in economic activities that do not qualify as environmentally sustainable under the EU Taxonomy	<input checked="" type="checkbox"/> It promotes Environmental/Social (E/S) characteristics and while it does not have as its objective a sustainable investment, it will have a minimum proportion of 5.00% of sustainable investments <input checked="" type="checkbox"/> with an environmental objective in economic activities that qualify as environmentally sustainable under the EU Taxonomy <input checked="" type="checkbox"/> with an environmental objective in economic activities that do not qualify as environmentally sustainable under the EU Taxonomy <input checked="" type="checkbox"/> with a social objective
<input type="checkbox"/> It will make a minimum of sustainable investments with a social objective ____%	<input type="checkbox"/> It promotes E/S characteristics, but will not make any sustainable investments



What environmental and/or social characteristics are promoted by this financial product?

Allianz Japan Equity (the "Sub-Fund") is managed according to the Sustainability Key Performance Indicator Strategy (Relative) ("KPI Strategy (Relative)") which addresses greenhouse gas (GHG) Intensity. The "Sustainability KPI" measures the GHG Intensity defined by the weighted average intensity of greenhouse gas emissions based on company's annual sales ("GHG Intensity").

GHG Intensity will be addressed by outperforming the Weighted Average GHG Intensity against its benchmark.

In addition, sustainable minimum exclusion criteria apply.

A reference benchmark has been designated for the purpose of attaining the environmental and/or social characteristics promoted by the Sub-Fund.

● What sustainability indicators are used to measure the attainment of each of the environmental or social characteristics promoted by this financial product?

To measure the attainment of the environmental and/or social characteristics the following sustainability indicators are used and reported on, at the fiscal year end:

- The actual percentage of KPI coverage of the Sub-Fund's Portfolio (Portfolio in this respect does not comprise derivatives and instruments that are non-evaluated by nature (e. g., cash and deposits)).
- The actual weighted average GHG Intensity portfolio vs weighted average GHG Intensity of the benchmark.

Sustainability indicators measure how the environmental or social characteristics promoted by the financial product are attained.

- Confirmation that Principal Adverse Impacts (PAIs) of investment decisions on sustainability factors are considered through the application of exclusion criteria.
- **What are the objectives of the sustainable investments that the financial product partially intends to make and how does the sustainable investment contribute to such objectives?**

Sustainable investments contribute to environmental and/or social objectives, for which the Investment Manager uses as reference frameworks, among others, the UN Sustainable Development Goals (SDGs), as well as the objectives of the EU Taxonomy:

1. Climate Change Mitigation
2. Climate Change Adaptation
3. Sustainable Use and Protection of Water and Marine Resources
4. Transition to a Circular Economy
5. Pollution Prevention and Control
6. Protection and Restoration of Biodiversity and Ecosystems

The assessment of the positive contribution to the environmental or social objectives is based on a proprietary framework which combines quantitative elements with qualitative inputs from internal research. The methodology applies first a quantitative breakdown of a securities issuer into its business activities. The qualitative element of the framework is an assessment if business activities contribute positively to an environmental or a social objective.

To calculate the positive contribution on the Sub-Fund level the revenue share of each issuer attributable to business activities contributing to environmental and/or social objectives is considered provided the issuer is satisfying the Do No Significant Harm (“DNSH”) and Good Governance principles, and an asset-weighted aggregation is performed as a second step. Moreover, for certain types of securities, which finance specific projects contributing to environmental or social objectives the overall investment is considered to contribute to environmental and/or social objectives, but also for these a DNSH as well as a Good Governance check for issuers is performed.

- **How do the sustainable investments that the financial product partially intends to make, not cause significant harm to any environmental or social sustainable investment objective?**

In order to ensure that Sustainable Investments do not significantly harm any other environmental and/or social objective, the Investment Manager is leveraging the PAI indicators, whereby significance thresholds have been defined to identify significantly harmful issuers. Issuers not meeting the significance threshold can be engaged for a limited time period to remediate the adverse impact. Otherwise, if the issuer does not meet the defined significance thresholds twice subsequently or in case of a failed engagement, it does not pass the DNSH assessment. Investments in securities of issuers which do not pass the DNSH assessment are not counted as sustainable investments.

- *How have the indicators for adverse impacts on sustainability factors been taken into account?*

All mandatory PAI indicators are considered either as part of the application of the exclusion criteria or through thresholds on a sectorial or absolute basis. Significance thresholds have been defined and they refer to qualitative or quantitative criteria.

Recognizing the lack of data coverage for some of the PAI indicators equivalent data points are used to assess PAI indicators when applying the DNSH assessment, when relevant, for the following indicators for corporates: share of non-renewable energy consumption and production, activities negatively affecting biodiversity-sensitive areas, emissions to water, lack of processes and compliance mechanisms to monitor compliance with UNGC principles and OECD Guidelines for Multinational Enterprises; for sovereigns: GHG Intensity and investee countries subject to social violations. In case of securities which finance specific projects contributing to environmental or social objectives equivalent data at project level might be used to ensure that Sustainable Investments do not significantly harm any other environmental and/or social objective. The Investment Manager will strive to increase data coverage for PAI indicators with low data coverage by engaging with issuers and data providers. The Investment Manager will regularly evaluate whether the availability of data has increased sufficiently to potentially include assessment of such data in the investment process.

Principal adverse impacts are the most significant negative impacts of investment decisions on sustainability factors relating to environmental, social and employee matters, respect for human rights, anti-corruption and anti-bribery matters.

- *How are the sustainable investments aligned with the OECD Guidelines for Multinational Enterprises and the UN Guiding Principles on Business and Human Rights? Details:*

The Investment Manager's sustainable minimum exclusion list screens out companies based on their involvement in controversial practices against international norms. The core normative framework consists of the Principles of the UN Global Compact, the OECD Guidelines for Multinational Enterprises and the UN Guiding Principles for Business and Human Rights. Securities issued by companies having a severe violation of these frameworks will be restricted from the investment universe.

The EU Taxonomy sets out a "do not significant harm" principle by which Taxonomy-aligned investments should not significantly harm EU Taxonomy objectives and is accompanied by specific EU criteria.

The "do not significant harm" principle applies only to those investments underlying the financial product that take into account the EU criteria for environmentally sustainable economic activities. The investments underlying the remaining portion of this financial product do not take into account the EU criteria for environmentally sustainable economic activities.

Any other sustainable investments must also not significantly harm any environmental or social objectives.



Does this financial product consider principal adverse impacts on sustainability factors?

Yes

No

The Management Company has joined the Net Zero Asset Manager Initiative and considers PAI indicators through stewardship including engagement, both are relevant to mitigate potential adverse impact as a company.

Due to the commitment to the Net Zero Asset Manager Initiative, the Management Company aims to reduce greenhouse gas emissions in partnership with asset owner clients on decarbonisation goals, consistent with an ambition to reach net zero emission by 2050 or sooner across all assets under management. As part of this objective the Management Company will set an interim target for the proportion of assets to be managed in line with the attainment of net zero emissions by 2050 or sooner.

The Sub-Fund's Investment Manager addresses PAI indicators regarding greenhouse gas emission, biodiversity, water, waste as well as social and employee matters for corporate issuers, and, where relevant, the freedom house index is applied to investments in sovereigns. PAI indicators are considered within the Investment Manager's investment process through the means of exclusions as described in the "binding elements" section of the Sub-Fund.

The data coverage for the data required for the PAI indicators is heterogenous. The data coverage related to biodiversity, water and waste is low and the related PAI indicators are considered through exclusion of securities issued by companies having a severe violation / breach of principles and guidelines such as the Principles of the United Nations Global Compact, the OECD Guidelines for Multinational Enterprises, and the United Nations Guiding Principles for Business and Human Rights on the grounds of problematic practices around human rights, labour rights, environment, and corruption issues. Therefore, the Investment Manager will strive to increase data coverage for PAI indicators with low data coverage. The Investment Manager will regularly evaluate whether the availability of data has increased sufficiently to potentially include assessment of such data in the investment process.

Additionally, the Investment manager considers GHG related PAI indicators by outperforming the Weighted Average GHG Intensity against its benchmark. The following PAI indicators are considered:

Applicable to corporate issuers

- GHG Emissions
- Carbon footprint
- GHG Intensity of investee companies
- Exposure to companies active in the fossil fuel sector
- Activities negatively affecting biodiversity-sensitive areas
- Emissions to water
- Hazardous waste ratio
- Violation of UN Global compact principles

- Lack of processes and compliance mechanisms to monitor compliance with UN Global Compact principles
- Board gender diversity
- Exposure to controversial weapons

Applicable to sovereign and supranational issuers

- Investee countries subject to social violations

The information on the PAI indicators will be available in the end-year report of the Sub-Fund.



What investment strategy does this financial product follow?

The investment strategy guides investment decisions based on factors such as investment objectives and risk tolerance.

Allianz Japan Equity's investment objective is to invest in Japanese Equity Markets in accordance with the Sustainability Key Performance Indicator Strategy (Relative) ("KPI Strategy (Relative)").

The Sub-Fund's strategy is to outperform the Weighted Average GHG Intensity against its benchmark. The outperformance is determined as the excess between the Sub-Fund's weighted average GHG Intensity and the Sub-Fund's benchmark Weighted Average GHG Intensity.

The weighted average GHG Intensity is the weighted average of the Sub-Fund's GHG Intensity (in tCO₂e per Millions of sales). Sales represent company's annual sales. This ratio of GHG normalized by Sales facilitates comparison between companies of different sizes. The ratio is in tCO₂e per Millions of sales. The metric allows comparing weighted average GHG Intensities of different portfolios to identify portfolios comprised of more GHG-efficient issuers in terms of the issuer's sales. The portfolio weights (and benchmark or universe weights) are rebased such that only issuers with GHG emissions data available are considered in the calculation. GHG represents a respective issuer's greenhouse gas emissions. To determine the GHG Intensity of a company issuer, GHG Intensity data from third party data providers will be used. The GHG intensity is analysed by the Investment Manager and is considered within the securities selection process in order to meet the Sub-Fund Investment objective.

The proportion of assets which do not have a GHG intensity assessment is expected to be low. Examples of instruments not having a GHG intensity assessment are cash and deposits, some Target Funds, and investments for which the GHG intensity is deemed to be not appropriate and/or data is not available.

The Sub-Fund's general investment approach (Sub-Fund's applicable General Asset Class Principles in combination with its individual investment restrictions) is described in the prospectus.

● What are the binding elements of the investment strategy used to select the investments to attain each of the environmental or social characteristics promoted by this financial product?

The binding elements are:

- Min. 80% KPI coverage of the Sub-Fund's Portfolio (Portfolio in this respect does not comprise derivatives and instruments that are non-evaluated by nature (e. g., cash and deposits)).
- Min. 20% outperformance of benchmark in terms of Weighted Average GHG Intensity.
- Application of the following sustainable minimum exclusion criteria for direct investments:
 - securities issued by companies having a severe violation / breach of principles and guidelines such as the Principles of the United Nations Global Compact, the OECD Guidelines for Multinational Enterprises, and the United Nations Guiding Principles for Business and Human Rights on the grounds of problematic practices around human rights, labour rights, environment, and corruption,
 - securities issued by companies involved in controversial weapons (anti-personnel mines, cluster munitions, chemical weapons, biological weapons, depleted uranium, white phosphorus, and nuclear weapons),
 - securities issued by companies that derive more than 10% of their revenues from weapons, military equipment, and services,
 - securities issued by companies that derive more than 10% of their revenue from thermal coal extraction
 - securities issued by utility companies that generate more than 20% of their revenues from coal,
 - securities issued by companies involved in the production of tobacco, and securities issued by companies involved in the distribution of tobacco with more than 5% of their revenues.

Direct investments in sovereign issuers with an insufficient freedom house index score are excluded.

The sustainable minimum exclusion criteria are based on information from an external data provider and coded in pre- and post-trade compliance. The review is performed at least half yearly.

- **What is the committed minimum rate to reduce the scope of the investments considered prior to the application of that investment strategy?**

The Sub-Fund does not commit to reduce the scope of the investments by a certain minimum rate.

- **What is the policy to assess good governance practices of the investee companies?**

Good governance principles are considered by screening out companies based on their involvement in controversies around international norms corresponding to the four good governance practices: sound management structures, employee relations, remuneration of staff and tax compliance. Companies having a severe violation in either of those areas will not be investible. For certain cases, flagged issuers shall be on a watch list. These companies will appear on this watch list when the Investment Manager believes that engagement may lead to improvements or when the company is assessed to take remedial actions. Companies on the watch list remain investible unless the Investment Manager believes that the engagement or the remedial actions of the company does not lead to the desired remedy of the severe controversy.

In addition, the Sub-Fund's Investment Manager is committed to actively encourage open dialogues with investee companies on corporate governance, proxy voting and broader sustainability issues in advance of shareholder meetings (regularly for direct investments in shares). The Sub-Fund's Investment Manager's approach to proxy voting and company engagement is set out in the Management Company's Stewardship Statement.

Good governance practices include sound management structures, employee relations, remuneration of staff and tax compliance.



What is the asset allocation planned for this financial product?

Asset allocation describes the share of investments in specific assets.

Min. 80% of the Sub-Funds' assets (excluding cash, and derivatives) are used to meet the environmental or social characteristics promoted by this Sub-Fund. A low portion of the Sub-Fund might contain assets which do not promote environmental or social characteristics. Example of such instruments are derivatives, cash and deposits, some Target Funds and investment with temporarily divergent or absent environmental, social, or good governance qualifications. Min. 5% of the Sub-Funds' assets will be invested in Sustainable Investments. The Sub-Fund's Investment Manager does not commit to a minimum share of sustainable investments with an environmental objective aligned with the EU Taxonomy nor to a minimum share of environmentally Sustainable Investments that are not aligned with the EU Taxonomy. The Sub-Fund's Investment Manager does not commit to a minimum share of socially sustainable investments. While the Sub-Fund cannot commit to a minimum share of environmentally or socially sustainable investments, such investments may be freely allocated to within the Sub-Fund aggregated sustainable investment commitment disclosed (min. 5%).

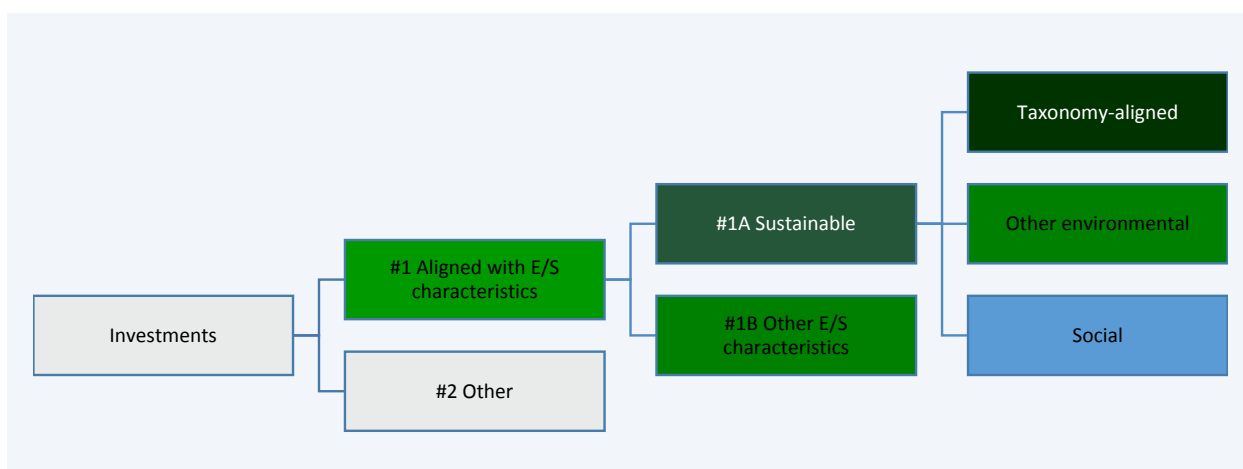

#1 Aligned with E/S characteristics includes the investments of the financial product used to attain the environmental or social characteristics promoted by the financial product.

#2 Other includes the remaining investments of the financial product which are neither aligned with the environmental or social characteristics, nor are qualified as sustainable investments.

The category **#1 Aligned with E/S characteristics** covers:

- The sub-category **#1A Sustainable** covers sustainable investments with environmental or social objectives.

- The sub-category #1B Other E/S characteristics covers investments aligned with the environmental or social characteristics that do not qualify as sustainable investments.

● **How does the use of derivatives attain the environmental or social characteristics promoted by the financial product?**

Not applicable



To what minimum extent are sustainable investments with an environmental objective aligned with the EU Taxonomy?

The Sub-Fund’s Investment Manager does not commit to a minimum share of sustainable investments with an environmental objective aligned with the EU Taxonomy. The overall sustainable investment share may also include investments with an environmental objective in economic activities that qualify as environmentally sustainable under the EU Taxonomy.

● **Does the financial product invest in fossil gas and/or nuclear energy related activities that comply with the EU Taxonomy ¹?**

- Yes:
 - In fossil gas
 - In nuclear energy
- No

The Sub-Fund does not pursue any investments in fossil gas and/or nuclear energy related activities that comply with the EU Taxonomy. Nevertheless, as result of this investment strategy, investments may occur in corporates which are also active in these activities. Further information will be provided as part of the annual reporting, if relevant.

The two graphs below show in green the minimum percentage of investments that are aligned with the EU Taxonomy. As there is no appropriate methodology to determine the Taxonomy-alignment of sovereign bonds, the first graph shows the Taxonomy-alignment in relation to all the investments of the financial product including sovereign bonds, while the second graph shows the Taxonomy-alignment only in relation to the investments of the financial product other than sovereign bonds.*

1. Taxonomy-alignment of investments including sovereign bonds*

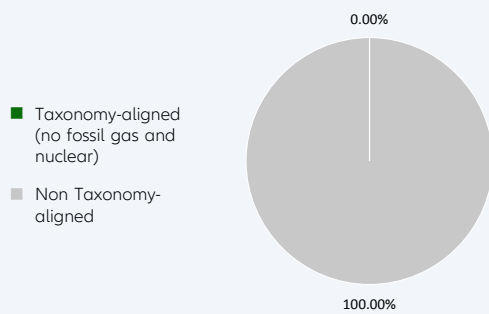

2. Taxonomy-alignment of investments excluding sovereign bonds*

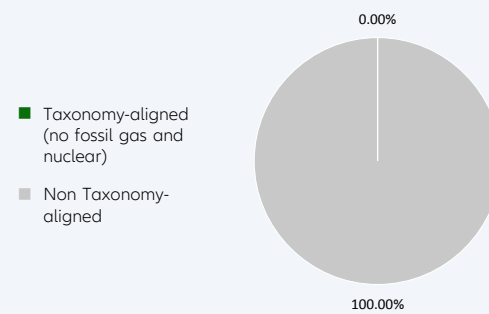

This graph represents X% of the total investments. It is noted that – due to the fact that this Sub-Fund does not provide for a minimum quota of taxonomy-aligned investments – this graph does not generate any additional added value compared to the left-hand graph.

* For the purpose of these graphs, ‘sovereign bonds’ consist of all sovereign exposures

● **What is the minimum share of investments in transitional and enabling activities?**

The Sub-Fund’s Investment Manager does not commit to a split of minimum taxonomy alignment into transitional, enabling activities and own performance.

Taxonomy-aligned activities are expressed as a share of:
 - **turnover** reflecting the share of revenue from green activities of investee companies
 - **capital expenditure (CapEx)** showing the green investments made by investee companies, e.g. for a transition to a green economy.
 - **operational expenditure (OpEx)** reflecting green operational activities of investee companies.

Enabling activities directly enable other activities to make a substantial contribution to an environmental objective.

¹ Fossil gas and/or nuclear related activities will only comply with the EU Taxonomy where they contribute to limiting climate change (“climate change mitigation”) and do not significantly harm any EU Taxonomy objective - see explanatory note in the left hand margin. The full criteria for fossil gas and nuclear energy economic activities that comply with the EU Taxonomy are laid down in Commission Delegated Regulation (EU) 2022/1214.

Transitional activities are activities for which low-carbon alternatives are not yet available and among others have greenhouse gas emission levels corresponding to the best performance.



What is the minimum share of sustainable investments with an environmental objective that are not aligned with the EU Taxonomy?

Taxonomy-aligned investments are considered a sub-category of Sustainable Investments. If an investment is not Taxonomy-aligned since the activity is not yet covered under the EU Taxonomy or the positive contribution is not substantial enough to comply with the Taxonomy technical screening criteria, the investment can still be considered an environmentally Sustainable Investment provided it complies with all criteria. The Investment Manager does not commit to a minimum share of environmentally Sustainable Investments that are not aligned with the EU Taxonomy. The overall sustainable investment share may also include investments with an environmental objective in economic activities that do not qualify as environmentally sustainable under the EU Taxonomy, and while the Sub-Fund cannot commit to a minimum share of environmentally or socially sustainable investments, such investments may be freely allocated to within the Sub-Fund aggregated sustainable investment commitment disclosed (min. 5%).



are sustainable investments with an environmental objective that **do not take into account the criteria** for environmentally sustainable economic activities under the EU Taxonomy.



What is the minimum share of socially sustainable investments?

The Investment Manager defines Sustainable Investments based on internal research, which uses, among others, the UN Sustainable Development Goals (SDGs), as well as the objectives of the EU Taxonomy as reference frameworks. The Investment Manager does not commit to a minimum share of socially Sustainable Investments, as the SDGs contain environmental as well as social objectives. The overall sustainable investment share may also include investments with a social objective, and while the Sub-Fund cannot commit to a minimum share of environmentally or socially sustainable investments, such investments may be freely allocated to within the Sub-Fund aggregated sustainable investment commitment disclosed (min. 5%).



What investments are included under “#2 Other”, what is their purpose and are there any minimum environmental or social safeguards?

Under “#2 Other” investments into cash, Target Funds, or derivatives can be included. Derivatives might be used for efficient portfolio management (including risk hedging) and/or investment purposes, and Target Funds to benefit from a specific strategy. For those investments no environmental or social safeguards are applied.



Is a specific index designated as a reference benchmark to determine whether this financial product is aligned with the environmental and/or social characteristics that it promotes?

Yes, the Sub-Fund has assigned the TOPIX Total Return Net as a benchmark. This benchmark is a market index. The Sub-Fund will promote environmental and social characteristics by outperforming the benchmark's Weighted Average GHG Intensity

● How is the reference benchmark continuously aligned with each of the environmental or social characteristics promoted by the financial product?

The benchmark is a market index and does not incorporate environmental or social characteristics for index construction.

Reference benchmarks are indexes to measure whether the financial product attains the environmental or social characteristics that they promote.

- **How is the alignment of the investment strategy with the methodology of the index ensured on a continuous basis?**

The benchmark is not continuously aligned as it does not incorporate environmental or social characteristics for index construction.

- **How does the designated index differ from a relevant broad market index?**

The benchmark is a broad market index.

- **Where can the methodology used for the calculation of the designated index be found?**

Details of the Benchmark's methodology may be found at https://www.jpx.co.jp/english/news/detail/detail_665.html



Where can I find more product specific information online?

More product-specific information can be found on the website: <https://regulatory.allianzgi.com/SFDR>

Template pre-contractual disclosure for the financial products referred to in Article 8, paragraphs 1, 2 and 2a, of Regulation (EU) 2019/2088 and Article 6, first paragraph, of Regulation (EU) 2020/852

Product name:

Allianz Laufzeitfonds

Legal entity identifier: New product - Not Identified

Environmental and/or social characteristics

Sustainable investment means an investment in an economic activity that contributes to an environmental or social objective, provided that the investment does not significantly harm any environmental or social objective and that the investee companies follow good governance practices.

The EU Taxonomy is a classification system laid down in Regulation (EU) 2020/852, establishing a list of environmentally sustainable economic activities. That Regulation does not include a list of socially sustainable economic activities. Sustainable investments with an environmental objective might be aligned with the Taxonomy or not.

Does this financial product have a sustainable investment objective?	
<input checked="" type="radio"/> <input checked="" type="radio"/> Yes	<input checked="" type="radio"/> <input type="radio"/> No
<input type="checkbox"/> It will make a minimum of sustainable investments with an environmental objective: ___% <ul style="list-style-type: none"> <input type="checkbox"/> in economic activities that qualify as environmentally sustainable under the EU Taxonomy <input type="checkbox"/> in economic activities that do not qualify as environmentally sustainable under the EU Taxonomy 	<input checked="" type="checkbox"/> It promotes Environmental/Social (E/S) characteristics and while it does not have as its objective a sustainable investment, it will have a minimum proportion of 5.00% of sustainable investments <ul style="list-style-type: none"> <input checked="" type="checkbox"/> with an environmental objective in economic activities that qualify as environmentally sustainable under the EU Taxonomy <input checked="" type="checkbox"/> with an environmental objective in economic activities that do not qualify as environmentally sustainable under the EU Taxonomy <input checked="" type="checkbox"/> with a social objective
<input type="checkbox"/> It will make a minimum of sustainable investments with a social objective ___% <ul style="list-style-type: none"> <input type="checkbox"/> It promotes E/S characteristics, but will not make any sustainable investments 	



What environmental and/or social characteristics are promoted by this financial product?

Allianz Laufzeitfonds (the Sub-Fund) is managed according to the Sustainability Key Performance Indicator Strategy (Relative) (KPI Strategy (Relative)) which addresses greenhouse gas (GHG) intensity. The Sustainability KPI measures the GHG Intensity defined by the weighted average intensity of greenhouse gas emissions based on company's annual sales (GHG Intensity).

GHG Intensity will be addressed by outperforming the Weighted Average GHG Intensity against its benchmark.

In addition, sustainable minimum exclusion criteria apply.

A reference benchmark has been designated for the the purpose of attaining the environmental and/or social characteristics promoted by the Sub-Fund

● What sustainability indicators are used to measure the attainment of each of the environmental or social characteristics promoted by this financial product?

To measure the attainment of the environmental and/or social characteristics the following sustainability indicators are used and reported on, at the fiscal year end:

- The actual percentage of KPI coverage of the Sub-Fund's Portfolio (Portfolio in this respect does not comprise non-rated derivatives and instruments that are non-rated by nature (e. g., cash and deposits))
- The actual weighted average GHG Intensity portfolio vs weighted average GHG Intensity of the benchmark

Sustainability indicators measure how the environmental or social characteristics promoted by the financial product are attained.

- Confirmation that Principal Adverse Impacts (PAIs) of investment decisions on sustainability factors are considered through the application of exclusion criteria.
- **What are the objectives of the sustainable investments that the financial product partially intends to make and how does the sustainable investment contribute to such objectives?**

Sustainable investments contribute to environmental and/or social objectives, for which the Investment Managers uses as reference frameworks, among others, the UN Sustainable Development Goals (SDGs), as well as the objectives of the EU Taxonomy:

1. Climate Change Mitigation
2. Climate Change Adaptation
3. Sustainable Use and Protection of Water and Marine Resources
4. Transition to a Circular Economy
5. Pollution Prevention and Control
6. Protection and Restoration of Biodiversity and Ecosystems

The assessment of the positive contribution to the environmental or social objectives is based on a proprietary framework which combines quantitative elements with qualitative inputs from internal research. The methodology applies first a quantitative breakdown of securities issuer into its business activities. The qualitative element of the framework is an assessment if business activities contribute positively to an environmental or a social objective.

To calculate the positive contribution on the Fund level the revenue share of each issuer attributable to business activities contributing to environmental and/or social objectives is considered provided the issuer is satisfying the Do No Significant Harm (DNSH) and Good Governance principles, and an asset-weighted aggregation is performed as a second step. Moreover, for certain types of securities, which finance specific projects contributing to environmental or social objectives the overall investment is considered to contribute to environmental and/or social objectives, but also for these a DNSH as well as a Good Governance check for issuers is performed.

- **How do the sustainable investments that the financial product partially intends to make, not cause significant harm to any environmental or social sustainable investment objective?**

In order to ensure that Sustainable Investments do not significantly harm any other environmental and/or social objective, the Investment Manager is leveraging the PAI indicators, whereby significance thresholds have been defined to identify significantly harmful issuers. Issuers not meeting the significance threshold can be engaged for a limited time period to remediate the adverse impact. Otherwise, if the issuer does not meet the defined significance thresholds twice subsequently or in case of a failed engagement, it does not pass the DNSH assessment. Investments in securities of issuers which do not pass the DNSH assessment are not counted as sustainable investments.

- *How have the indicators for adverse impacts on sustainability factors been taken into account?*

All mandatory PAI indicators are considered either as part of the application of the exclusion criteria or through thresholds on a sectorial or absolute basis. Significance thresholds have been defined and they refer to a qualitative or quantitative criteria.

Recognizing the lack of data coverage for some of the PAI indicators equivalent data points are used to assess PAI indicators when applying the DNSH assessment, when relevant, for the following indicators for corporates: share of non-renewable energy consumption and production, activities negatively affecting biodiversity-sensitive areas, emissions to water, lack of processes and compliance mechanisms to monitor compliance with UNGC principles and OECD Guidelines for Multinational Enterprises; for sovereigns: GHG Intensity and investee countries subject to social violations. In case of securities which finance specific projects contributing to environmental or social objectives equivalent data at project level might be used to ensure that Sustainable Investments do not significantly harm any other environmental and/or social objective. The Investment Manager will strive to increase data coverage for PAI indicators with low data coverage by engaging with issuers and data providers. The Investment Manager will regularly evaluate whether the availability of data has increased sufficiently to potentially include assessment of such data in the investment process.

Principal adverse impacts are the most significant negative impacts of investment decisions on sustainability factors relating to environmental, social and employee matters, respect for human rights, anti-corruption and anti-bribery matters.

- *How are the sustainable investments aligned with the OECD Guidelines for Multinational Enterprises and the UN Guiding Principles on Business and Human Rights? Details:*

The Investment Manager's sustainable minimum exclusion list screens out companies based on their involvement in controversial practices against international norms. The core normative framework consists of the Principles of the UN Global Compact, the OECD Guidelines for Multinational Enterprises and the UN Guiding Principles for Business and Human Rights. Securities issued by companies having a severe violation of these frameworks will be restricted from investment universe.

The EU Taxonomy sets out a "do not significant harm" principle by which Taxonomy-aligned investments should not significantly harm EU Taxonomy objectives and is accompanied by specific EU criteria.

The "do not significant harm" principle applies only to those investments underlying the financial product that take into account the EU criteria for environmentally sustainable economic activities. The investments underlying the remaining portion of this financial product do not take into account the EU criteria for environmentally sustainable economic activities.

Any other sustainable investments must also not significantly harm any environmental or social objectives.



Does this financial product consider principal adverse impacts on sustainability factors?

Yes

No

The Management Company has joined the Net Zero Asset Manager Initiative and considers PAI indicators through stewardship including engagement, both are relevant to mitigate potential adverse impact as a company.

Due to the commitment to the Net Zero Asset Manager Initiative, the Management Company aims to reduce greenhouse gas emissions in partnership with asset owner clients on decarbonisation goals, consistent with an ambition to reach net zero emission by 2050 or sooner across all assets under management. As part of this objective the Management Company will set an interim target for the proportion of assets to be managed in line with the attainment of net zero emissions by 2050 or sooner.

The Sub-Fund's Investment Manager addresses PAI indicators regarding greenhouse gas emission, biodiversity, water, waste as well as social and employee matters for corporate issuers, and, where relevant, the freedom house index is applied to investments in sovereigns. PAI indicators are considered within the Investment Manager's investment process through the means of exclusions as described in the binding elements section of the Sub-Fund.

The data coverage for the data required for the PAI indicators is heterogenous. The data coverage related to biodiversity, water and waste is low and the related PAI indicators are considered through exclusion of securities issued by companies having a severe violation / breach of principles and guidelines such as the Principles of the United Nations Global Compact, the OECD Guidelines for Multinational Enterprises, and the United Nations Guiding Principles for Business and Human Rights on the grounds of problematic practices around human rights, labour rights, environment, and corruption issues. Therefore, the Investment Manager will strive to increase data coverage for PAI indicators with low data coverage. The Investment Manager will regularly evaluate whether the availability of data has increased sufficiently to potentially include assessment of such data in the investment process.

Additionally, the Investment Manger considers GHG related PAI indicators by outperforming the Weighted Average GHG Intensity against its benchmark. The following PAI indicators are considered:

Applicable to corporate issuers

- GHG Emissions
- Carbon footprint
- GHG Intensity of investee companies
- Exposure to companies active in the fossil fuel sector
- Activities negatively affecting biodiversity-sensitive areas
- Emissions to water
- Hazardous waste ratio
- Violation of UN Global compact principles

- Lack of processes and compliance mechanisms to monitor compliance with UN Global Compact principles
- Board gender diversity
- Exposure to controversial weapons

Applicable to sovereign and supranational issuers

- Investee countries subject to social violations

The information on the PAI indicators will be available in the end-year report of the Sub-Fund.



What investment strategy does this financial product follow?

The investment strategy guides investment decisions based on factors such as investment objectives and risk tolerance.

Allianz Laufzeitfonds' investment objective is to invest in Debt Securities of Global bond markets (Euro denominated) in accordance with the Sustainability Key Performance Indicator Strategy (Relative) ("KPI Strategy (Relative)").

The Sub-Fund's strategy is to outperform the Weighted Average GHG Intensity against its benchmark. The outperformance is determined as the excess between the Sub-Fund's weighted average GHG Intensity and the Sub-Fund's benchmark Weighted Average GHG Intensity.

The weighted average GHG Intensity is the weighted average of the Sub-Fund's GHG Intensity (in tCO₂e per Millions of sales). Sales represent company's annual sales. This ratio of GHG normalized by Sales facilitates comparison between companies of different sizes. The ratio is in tCO₂e per Millions of sales. The metric allows comparing weighted average GHG Intensities of different portfolios to identify portfolios comprised of more GHG-efficient issuers in terms of the issuer's sales. The portfolio weights (and benchmark or universe weights) are rebased such that only issuers with GHG emissions data available are considered in the calculation. GHG represents a respective issuer's greenhouse gas emissions. To determine the GHG Intensity of a company issuer, GHG Intensity data from third party data providers will be used. The GHG intensity is analysed by the Investment Manager and is considered within the securities selection process in order to meet the Sub-Fund Investment objective.

The proportion of assets which do not have a GHG intensity assessment is expected to be low. Examples of instruments not having a GHG intensity assessment are cash and deposits, some Target Funds, and investments for which the GHG intensity is deemed to be not appropriate and/or data is not available.

The Sub-Fund's general investment approach (Sub-Fund's applicable General Asset Class Principles in combination with its individual investment restrictions) is described in the prospectus.

● What are the binding elements of the investment strategy used to select the investments to attain each of the environmental or social characteristics promoted by this financial product?

The binding elements are:

- Min. 80% KPI coverage of the Sub-Fund's Portfolio (Portfolio in this respect does not comprise non-rated derivatives and instruments that are non-rated by nature (e. g., cash and deposits))
- Min. 20% outperformance of benchmark in terms of Weighted Average GHG Intensity
- Application of the below sustainable minimum exclusion criteria.

The following sustainable minimum exclusion criteria for direct investments:

- securities issued by companies having a severe violation / breach of principles and guidelines such as the Principles of the United Nations Global Compact, the OECD Guidelines for Multinational Enterprises, and the United Nations Guiding Principles for Business and Human Rights on the grounds of problematic practices around human rights, labour rights, environment, and corruption issues,
- securities issued by companies involved in controversial weapons (anti-personnel mines, cluster munitions, chemical weapons, biological weapons, depleted uranium, white phosphorus, and nuclear weapons),
- securities issued by companies that derive more than 10% of their revenues from weapons, military equipment, and services,
- securities issued by companies that derive more than 10% of their revenue from thermal coal extraction,
- securities issued by utility companies that generate more than 20% of their revenues from coal,

- securities issued by companies involved in the production of tobacco, and securities issued by companies involved in the distribution of tobacco with more than 5% of their revenues.

Direct investments in sovereign issuers with an insufficient freedom house index score are excluded.

The sustainable minimum exclusion criteria are based on information from an external data provider and coded in pre- and post-trade compliance. The review is performed at least half yearly.

- **What is the committed minimum rate to reduce the scope of the investments considered prior to the application of that investment strategy?**

Not applicable

- **What is the policy to assess good governance practices of the investee companies?**

Good governance principles are considered by screening out companies based on their involvement in controversies around international norms corresponding to the four good governance practices: sound management structures, employee relations, remuneration of staff and tax compliance. Companies having a severe violation in either of those areas will not be investible. For certain cases, flagged issuers shall be on a watch list. These companies will appear on this watch list when the Investment Manager believes that engagement may lead to improvements or when the company is assessed to take remedial actions. Companies on the watch list remain investible unless the Investment Manager believes that our engagement or the remedial actions of the company does not lead to the desired remedy of the severe controversy.

In addition, the Sub-Fund's Investment Manager is committed to actively encourage open dialogues with investee companies on corporate governance, proxy voting and broader sustainability issues in advance of shareholder meetings (regularly for direct investments in shares). The Sub-Fund's Investment Manager's approach to proxy voting and company engagement is set out in the Management Company's Stewardship Statement.

Good governance practices include sound management structures, employee relations, remuneration of staff and tax compliance.



What is the asset allocation planned for this financial product?

Asset allocation describes the share of investments in specific assets.

Min. 80% of the Sub-Fund assets (excluding cash and non-rated derivatives) are used to meet the environmental or social characteristics promoted by this Sub-Fund. A low portion of the Sub-Fund might contain assets which do not promote environmental or social characteristics. Examples of such instruments are derivatives, cash and deposits, some Target Funds and investment with temporarily divergent or absent environmental, social, or good governance qualifications. Min. 5% of the Sub-Fund assets will be invested in Sustainable Investments.

The minimum percentage of investments that are aligned with the EU Taxonomy is 0,01%. The Sub-Fund's Investment Manager does not commit to a minimum share of environmentally Sustainable Investments that are not aligned with the EU Taxonomy. The Sub-Fund's Investment Manager does not commit to a minimum share of socially sustainable investments. While the Sub-Fund cannot commit to a minimum share of environmentally or socially sustainable investments, such investments may be freely allocated to within the Sub-Fund aggregated sustainable investment commitment disclosed (min. 5%).

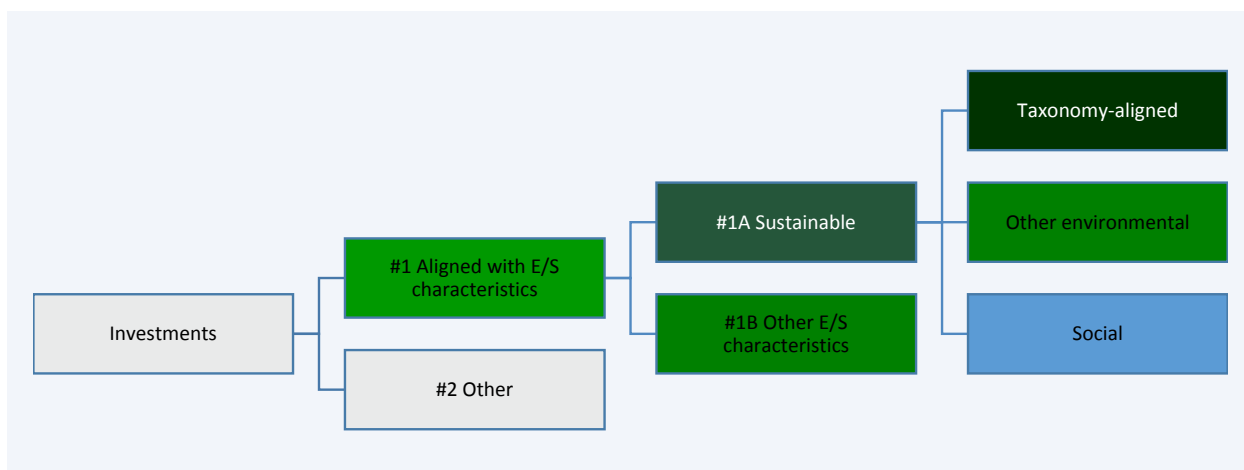

#1 Aligned with E/S characteristics includes the investments of the financial product used to attain the environmental or social characteristics promoted by the financial product.

#2 Other includes the remaining investments of the financial product which are neither aligned with the environmental or social characteristics, nor are qualified as sustainable investments.

The category **#1 Aligned with E/S characteristics** covers:

- The sub-category **#1A Sustainable** covers sustainable investments with environmental or social objectives.
- The sub-category **#1B Other E/S characteristics** covers investments aligned with the environmental or social characteristics that do not qualify as sustainable investments.

- **How does the use of derivatives attain the environmental or social characteristics promoted by the financial product?**

Not applicable



To what minimum extent are sustainable investments with an environmental objective aligned with the EU Taxonomy?

The Taxonomy-aligned investments include debt and/or equity in environmentally sustainable economic activities aligned with the EU-Taxonomy. The minimum percentage of investments that are aligned with the EU Taxonomy is 0,01%. Taxonomy-aligned data is provided by an external data provider. The Investment Manager has assessed the quality of such data. The data will not be subject to an assurance provided by auditors or a review by third parties. The data will not reflect any data in government bonds. As of today, there is no recognized methodology available to determine the proportion of Taxonomy-aligned activities when investing in government bonds.

Taxonomy-aligned activities in this disclosure are based on share of turnover. Pre-contractual figures use turnover as its financial metric as a default in line with the regulatory requirements and based on the fact that complete, verifiable or up-to date data for CAPEX and/or OPEX as financial metric is even less available.

Taxonomy-aligned data is only in rare cases data reported by companies in accordance with the EU Taxonomy. The data provider has derived Taxonomy-aligned data from other available equivalent public data.

- **Does the financial product invest in fossil gas and/or nuclear energy related activities that comply with the EU Taxonomy¹?**

Yes:

In fossil gas In nuclear energy

No

The Sub-Fund does not pursue any investments in fossil gas and/or nuclear energy related activities that comply with the EU taxonomy. Nevertheless, as result of this investment strategy, investments may occur in corporates which are also active in these activities. Further information will be provided as part of the annual reporting, if relevant.

Taxonomy-aligned activities are expressed as a share of:

- **turnover** reflecting the share of revenue from green activities of investee companies
- **capital expenditure** (CapEx) showing the green investments made by investee companies, e.g. for a transition to a green economy.
- **operational expenditure** (OpEx) reflecting green operational activities of investee companies.

¹ Fossil gas and/or nuclear related activities will only comply with the EU Taxonomy where they contribute to limiting climate change ("climate change mitigation") and do not significantly harm any EU Taxonomy objective - see explanatory note in the left hand margin. The full criteria for fossil gas and nuclear energy economic activities that comply with the EU Taxonomy are laid down in Commission Delegated Regulation (EU) 2022/1214.

The two graphs below show in green the minimum percentage of investments that are aligned with the EU Taxonomy. As there is no appropriate methodology to determine the Taxonomy-alignment of sovereign bonds*, the first graph shows the Taxonomy-alignment in relation to all the investments of the financial product including sovereign bonds, while the second graph shows the Taxonomy-alignment only in relation to the investments of the financial product other than sovereign bonds.

1. Taxonomy-alignment of investments including sovereign bonds*

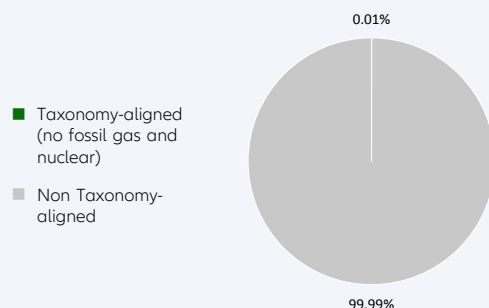

2. Taxonomy-alignment of investments excluding sovereign bonds*

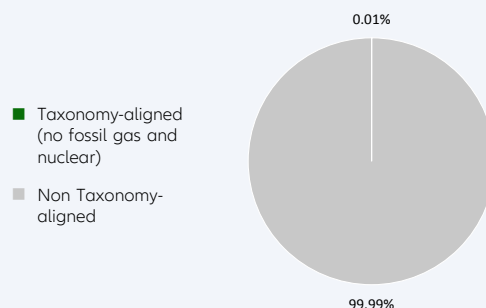

This graph represents X% of the total investments. It is noted that this Sub-Fund does not provide for a binding minimum quota for investments in sovereign bonds. Therefore, this Sub-Fund may have (but must not have) an exposure to sovereign bonds. In the absence of a binding minimum quota for investments in sovereign bonds, this graph does not generate any additional added value compared to the left-hand graph.

* For the purpose of these graphs, 'sovereign bonds' consist of all sovereign exposures

Enabling activities directly enable other activities to make a substantial contribution to an environmental objective.

Transitional activities are activities for which low-carbon alternatives are not yet available and among others have greenhouse gas emission levels corresponding to the best performance.

● **What is the minimum share of investments in transitional and enabling activities?**

The Sub-Fund's Investment Manager does not commit to a split of minimum taxonomy alignment into transitional and enabling activities and own performance.



What is the minimum share of sustainable investments with an environmental objective that are not aligned with the EU Taxonomy?

Taxonomy-aligned investments are considered a sub-category of Sustainable Investments. If an investment is not Taxonomy-aligned since the activity is not yet covered under the EU Taxonomy or the positive contribution is not substantial enough to comply with the Taxonomy technical screening criteria, the investment can still be considered an environmentally Sustainable Investment provided it complies with all criteria. The Investment Manager does not commit to a minimum share of environmentally Sustainable Investments that are not aligned with the EU Taxonomy. The overall sustainable investment share may also include investments with an environmental objective in economic activities that do not qualify as environmentally sustainable under the EU Taxonomy, and while the Sub-Fund cannot commit to a minimum share of environmentally or socially sustainable investments, such investments may be freely allocated to within the Sub-Fund aggregated sustainable commitment disclosed (min.5).



are sustainable investments with an environmental objective that **do not take into account the criteria** for environmentally sustainable economic activities under the EU Taxonomy.



What is the minimum share of socially sustainable investments?

The Investment Manager defines Sustainable Investments based on internal research, which uses, among others, the UN Sustainable Development Goals (SDGs), as well as the objectives of the EU Taxonomy as reference frameworks. The Investment Manager does not commit to a minimum share of socially Sustainable Investments, as the SDGs contain environmental as well as social objectives. The overall sustainable investment share may also include investments with a social objective, and while the Sub-Fund cannot commit to a minimum share of environmentally or socially sustainable investments, such investments may be freely allocated to within the Sub-Fund aggregated sustainable investment commitment disclosed (min.5%).



What investments are included under “#2 Other”, what is their purpose and are there any minimum environmental or social safeguards?

Under #2 Other investments into cash, Target Funds, or derivatives can be included. Derivatives might be used for efficient portfolio management (including risk hedging) and/or investment purposes, and Target Funds to benefit from a specific strategy. For those investments no environmental or social safeguards are applied.



Is a specific index designated as a reference benchmark to determine whether this financial product is aligned with the environmental and/or social characteristics that it promotes?

Yes, the Sub-Fund has assigned ICE BofA Euro Corporate Index as benchmark.

- **How is the reference benchmark continuously aligned with each of the environmental or social characteristics promoted by the financial product?**

The benchmark is a market index and does not incorporate environmental or social characteristics for index construction

- **How is the alignment of the investment strategy with the methodology of the index ensured on a continuous basis?**

The benchmark is not continuously aligned as it does not incorporate environmental or social characteristics for index construction

- **How does the designated index differ from a relevant broad market index?**

The benchmark is a broad market index.

- **Where can the methodology used for the calculation of the designated index be found?**

Details of the Benchmark's methodology may be found at <https://www.theice.com/market-data/indices/fixed-income-indices>



Where can I find more product specific information online?

More product-specific information can be found on the website: <https://regulatory.allianzgi.com/SFDR>

Reference benchmarks are indexes to measure whether the financial product attains the environmental or social characteristics that they promote.

Template pre-contractual disclosure for the financial products referred to in Article 8, paragraphs 1, 2 and 2a, of Regulation (EU) 2019/2088 and Article 6, first paragraph, of Regulation (EU) 2020/852

Product name:

Allianz Pet and Animal Wellbeing

Legal entity identifier: 529900WR8ULGAFRMO18

Environmental and/or social characteristics

Sustainable investment means an investment in an economic activity that contributes to an environmental or social objective, provided that the investment does not significantly harm any environmental or social objective and that the investee companies follow good governance practices.

The **EU Taxonomy** is a classification system laid down in Regulation (EU) 2020/852, establishing a list of **environmentally sustainable economic activities**. That Regulation does not include a list of socially sustainable economic activities. Sustainable investments with an environmental objective might be aligned with the Taxonomy or not.

Does this financial product have a sustainable investment objective?	
Yes	No
<input type="checkbox"/> It will make a minimum of sustainable investments with an environmental objective : ____% <input type="checkbox"/> in economic activities that qualify as environmentally sustainable under the EU Taxonomy <input type="checkbox"/> in economic activities that do not qualify as environmentally sustainable under the EU Taxonomy	<input checked="" type="checkbox"/> It promotes Environmental/Social (E/S) characteristics and while it does not have as its objective a sustainable investment, it will have a minimum proportion of 20.00% of sustainable investments <input checked="" type="checkbox"/> with an environmental objective in economic activities that qualify as environmentally sustainable under the EU Taxonomy <input checked="" type="checkbox"/> with an environmental objective in economic activities that do not qualify as environmentally sustainable under the EU Taxonomy <input checked="" type="checkbox"/> with a social objective
<input type="checkbox"/> It will make a minimum of sustainable investments with a social objective ____%	<input type="checkbox"/> It promotes E/S characteristics, but will not make any sustainable investments



What environmental and/or social characteristics are promoted by this financial product?

Allianz Pet and Animal Wellbeing (the “Sub-Fund”) is managed according to the Sustainability Key Performance Indicator Strategy (Absolute Threshold) (“KPI Strategy (Absolute Threshold)”) which targets a specific minimum allocation into Sustainable Investments. Sustainable investments are investments in economic activities which contribute to environmental and/or social objectives, for which the Investment Managers uses as reference frameworks the UN Sustainable Development Goals (SDGs), as well as the objectives of the EU Taxonomy.

Furthermore, the Sub-Fund will limit its allocation into issuers which significantly harm environmental and/or social objectives.

In addition, sustainable minimum exclusion criteria apply.

No reference benchmark has been designated for the purpose of attaining the environmental and/or social characteristics promoted by the Sub-Fund.

● What sustainability indicators are used to measure the attainment of each of the environmental or social characteristics promoted by this financial product?

To measure the attainment of the environmental and/or social characteristics the following sustainability indicators are used and reported on, at the fiscal year end:

- The actual percentage of KPI coverage of the Sub-Fund’s Portfolio (Portfolio in this respect does not comprise derivatives and instruments that are non-evaluated by nature (e. g., cash and deposits)).
- The actual weighted average sustainable investment share of Sub-Fund Assets.

Sustainability indicators measure how the environmental or social characteristics promoted by the financial product are attained.

- The actual share of investments not satisfying the Do No Significant Harm (“DNSH”) assessment of Sub-Fund Assets.
 - Confirmation that Principal Adverse Impacts (PAIs) of investment decisions on sustainability factors are considered through the application of exclusion criteria.
- **What are the objectives of the sustainable investments that the financial product partially intends to make and how does the sustainable investment contribute to such objectives?**

Sustainable investments contribute to environmental and/or social objectives, for which the Investment Manager uses as reference frameworks, among others, the UN Sustainable Development Goals (SDGs), as well as the objectives of the EU Taxonomy:

1. Climate Change Mitigation
2. Climate Change Adaptation
3. Sustainable Use and Protection of Water and Marine Resources
4. Transition to a Circular Economy
5. Pollution Prevention and Control
6. Protection and Restoration of Biodiversity and Ecosystems

The assessment of the positive contribution to the environmental or social objectives is based on a proprietary framework which combines quantitative elements with qualitative inputs from internal research. The methodology applies first a quantitative breakdown of a securities issuer into its business activities. The qualitative element of the framework is an assessment if business activities contribute positively to an environmental or a social objective.

To calculate the positive contribution on the Sub-Fund level the revenue share of each issuer attributable to business activities contributing to environmental and/or social objectives is considered provided the issuer is satisfying the Do No Significant Harm (“DNSH”) and Good Governance principles, and an asset-weighted aggregation is performed as a second step. Moreover, for certain types of securities, which finance specific projects contributing to environmental or social objectives the overall investment is considered to contribute to environmental and/or social objectives, but also for these a DNSH as well as a Good Governance check for issuers is performed.

- **How do the sustainable investments that the financial product partially intends to make, not cause significant harm to any environmental or social sustainable investment objective?**

In order to ensure that Sustainable Investments do not significantly harm any other environmental and/or social objective, the Investment Manager is leveraging the PAI indicators, whereby significance thresholds have been defined to identify significantly harmful issuers. Issuers not meeting the significance threshold can be engaged for a limited time period to remediate the adverse impact. Otherwise, if the issuer does not meet the defined significance thresholds twice subsequently or in case of a failed engagement, it does not pass the DNSH assessment. Investments in securities of issuers which do not pass the DNSH assessment are not counted as sustainable investments.

- *How have the indicators for adverse impacts on sustainability factors been taken into account?*

All mandatory PAI indicators are considered either as part of the application of the exclusion criteria or through thresholds on a sectorial or absolute basis. Significance thresholds have been defined and they refer to qualitative or quantitative criteria.

Recognizing the lack of data coverage for some of the PAI indicators equivalent data points are used to assess PAI indicators when applying the DNSH assessment, when relevant, for the following indicators for corporates: share of non-renewable energy consumption and production, activities negatively affecting biodiversity-sensitive areas, emissions to water, lack of processes and compliance mechanisms to monitor compliance with UNGC principles and OECD Guidelines for Multinational Enterprises; for sovereigns: GHG Intensity and investee countries subject to social violations. In case of securities which finance specific projects contributing to environmental or social objectives equivalent data at project level might be used to ensure that Sustainable Investments do not significantly harm any other environmental and/or social objective. The Investment Manager will strive to increase data coverage for PAI indicators with low data coverage by engaging with issuers and data providers. The Investment Manager will regularly evaluate whether the availability of data has increased sufficiently to potentially include assessment of such data in the investment process.

Principal adverse impacts are the most significant negative impacts of investment decisions on sustainability factors relating to environmental, social and employee matters, respect for human rights, anti-corruption and anti-bribery matters.

- *How are the sustainable investments aligned with the OECD Guidelines for Multinational Enterprises and the UN Guiding Principles on Business and Human Rights? Details:*

The Investment Manager's sustainable minimum exclusion list screens out companies based on their involvement in controversial practices against international norms. The core normative framework consists of the Principles of the UN Global Compact, the OECD Guidelines for Multinational Enterprises and the UN Guiding Principles for Business and Human Rights. Securities issued by companies having a severe violation of these frameworks will be restricted from the investment universe.

The EU Taxonomy sets out a "do not significant harm" principle by which Taxonomy-aligned investments should not significantly harm EU Taxonomy objectives and is accompanied by specific EU criteria.

The "do not significant harm" principle applies only to those investments underlying the financial product that take into account the EU criteria for environmentally sustainable economic activities. The investments underlying the remaining portion of this financial product do not take into account the EU criteria for environmentally sustainable economic activities.

Any other sustainable investments must also not significantly harm any environmental or social objectives.



Does this financial product consider principal adverse impacts on sustainability factors?

Yes

No

The Management Company has joined the Net Zero Asset Manager Initiative and considers PAI indicators through stewardship including engagement, both are relevant to mitigate potential adverse impact as a company.

Due to the commitment to the Net Zero Asset Manager Initiative, the Management Company aims to reduce greenhouse gas emissions in partnership with asset owner clients on decarbonisation goals, consistent with an ambition to reach net zero emission by 2050 or sooner across all assets under management. As part of this objective the Management Company will set an interim target for the proportion of assets to be managed in line with the attainment of net zero emissions by 2050 or sooner.

The Sub-Fund's Investment Manager addresses PAI indicators regarding greenhouse gas emission, biodiversity, water, waste as well as social and employee matters for corporate issuers, and, where relevant, the freedom house index is applied to investments in sovereigns. PAI indicators are considered within the Investment Manager's investment process through the means of exclusions as described in the "binding elements" section of the Sub-Fund.

The data coverage for the data required for the PAI indicators is heterogenous. The data coverage related to biodiversity, water and waste is low and the related PAI indicators are considered through exclusion of securities issued by companies having a severe violation / breach of principles and guidelines such as the Principles of the United Nations Global Compact, the OECD Guidelines for Multinational Enterprises, and the United Nations Guiding Principles for Business and Human Rights on the grounds of problematic practices around human rights, labour rights, environment, and corruption issues. Therefore, the Investment Manager will strive to increase data coverage for PAI indicators with low data coverage. The Investment Manager will regularly evaluate whether the availability of data has increased sufficiently to potentially include assessment of such data in the investment process.

Additionally, the investment Manager considers PAI indicators by limiting its allocation into issuers which significantly harm environmental and/or social objectives.

The following PAI indicators are considered:

Applicable to corporate issuers

- GHG Emissions
- Carbon footprint
- GHG Intensity of investee companies
- Exposure to companies active in the fossil fuel sector
- Activities negatively affecting biodiversity-sensitive areas
- Emissions to water
- Hazardous waste ratio

- Violation of UN Global compact principles
- Lack of processes and compliance mechanisms to monitor compliance with UN Global Compact principles
- Board gender diversity
- Exposure to controversial weapons

Applicable to sovereign and supranational issuers

- Investee countries subject to social violations

The information on the PAI indicators will be available in the end-year report of the Sub-Fund.



What investment strategy does this financial product follow?

The investment strategy guides investment decisions based on factors such as investment objectives and risk tolerance.

Allianz Pet and Animal Wellbeing's investment objective is to invest in global equity markets with a focus on the evolution and development of pet and animal wellbeing in accordance with the Sustainability Key Performance Indicator Strategy (Absolute Threshold) ("KPI Strategy (Absolute Threshold)"). The Sub-Fund's strategy is to target a specific minimum allocation into Sustainable Investments and limit its allocation to DNSH.

The proportion of assets which do not have a Sustainable Investment share assessment is expected to be low. Examples of instruments not having a Sustainable Investment share assessment are cash and deposits, some Target Funds, and investments for which data is not available.

The Sub-Fund's general investment approach (Sub-Fund's applicable General Asset Class Principles in combination with its individual investment restrictions) is described in the prospectus.

● What are the binding elements of the investment strategy used to select the investments to attain each of the environmental or social characteristics promoted by this financial product?

The investment strategy adheres to the following binding elements to attain the environmental and/ or social characteristics promoted:

- Min. 80% of Sub-Fund's portfolio shall be invested in companies which have been assessed according to the Sustainable Investment methodology (Portfolio in this respect does not comprise derivatives and instruments that are non-evaluated by nature (e. g., cash and deposits)).
- Min. 20% of weighted-average Sustainable Investment share at Sub Fund Assets. If the Investment Manager acquires a use of proceed security, which finance specific projects contributing to environmental or social objectives, the overall investment is considered to contribute to environmental and/or social objectives according to the Sustainable Investment methodology.
- Max. 10% of Sub-Fund assets will be invested in securities from issuers not satisfying the Do No Significant Harm ("DNSH") principles.
- Application of the following sustainable minimum exclusion criteria for direct investments:
 - securities issued by companies having a severe violation / breach of principles and guidelines such as the Principles of the United Nations Global Compact, the OECD Guidelines for Multinational Enterprises, and the United Nations Guiding Principles for Business and Human Rights on the grounds of problematic practices around human rights, labour rights, environment, and corruption,
 - securities issued by companies involved in controversial weapons (anti-personnel mines, cluster munitions, chemical weapons, biological weapons, depleted uranium, white phosphorus, and nuclear weapons),
 - securities issued by companies that derive more than 10% of their revenues from weapons, military equipment, and services,
 - securities issued by companies that derive more than 10% of their revenue from thermal coal extraction
 - securities issued by utility companies that generate more than 20% of their revenues from coal,
 - securities issued by companies involved in the production of tobacco, and securities issued by companies involved in the distribution of tobacco with more than 5% of their revenues.

Direct investments in sovereign issuers with an insufficient freedom house index score are excluded.

The sustainable minimum exclusion criteria are based on information from an external data provider and coded in pre- and post-trade compliance. The review is performed at least half yearly.

- **What is the committed minimum rate to reduce the scope of the investments considered prior to the application of that investment strategy?**

The Sub-Fund does not commit to reduce the scope of the investments by a certain minimum rate.

- **What is the policy to assess good governance practices of the investee companies?**

Good governance principles are considered by screening out companies based on their involvement in controversies around international norms corresponding to the four good governance practices: sound management structures, employee relations, remuneration of staff and tax compliance. Companies having a severe violation in either of those areas will not be investible. For certain cases, flagged issuers shall be on a watch list. These companies will appear on this watch list when the Investment Manager believes that engagement may lead to improvements or when the company is assessed to take remedial actions. Companies on the watch list remain investible unless the Investment Manager believes that the engagement or the remedial actions of the company does not lead to the desired remedy of the severe controversy.

In addition, the Sub-Fund's Investment Manager is committed to actively encourage open dialogues with investee companies on corporate governance, proxy voting and broader sustainability issues in advance of shareholder meetings (regularly for direct investments in shares). The Sub-Fund's Investment Manager's approach to proxy voting and company engagement is set out in the Management Company's Stewardship Statement.

Good governance practices include sound management structures, employee relations, remuneration of staff and tax compliance.



What is the asset allocation planned for this financial product?

Asset allocation describes the share of investments in specific assets.

Min. 80% of the Sub-Funds' assets (excluding cash, and derivatives) are used to meet the environmental or social characteristics promoted by this Sub-Fund. A low portion of the Sub-Fund might contain assets which do not promote environmental or social characteristics. Example of such instruments are derivatives, cash and deposits, some Target Funds and investment with temporarily divergent or absent environmental, social, or good governance qualifications. Min. 20% of the Sub-Funds' assets will be invested in Sustainable Investments. The Sub-Fund's Investment Manager does not commit to a minimum share of sustainable investments with an environmental objective aligned with the EU Taxonomy nor to a minimum share of environmentally Sustainable Investments that are not aligned with the EU Taxonomy. The Sub-Fund's Investment Manager does not commit to a minimum share of socially sustainable investments. While the Sub-Fund cannot commit to a minimum share of environmentally or socially sustainable investments, such investments may be freely allocated to within the Sub-Fund aggregated sustainable investment commitment disclosed (min. 20%).

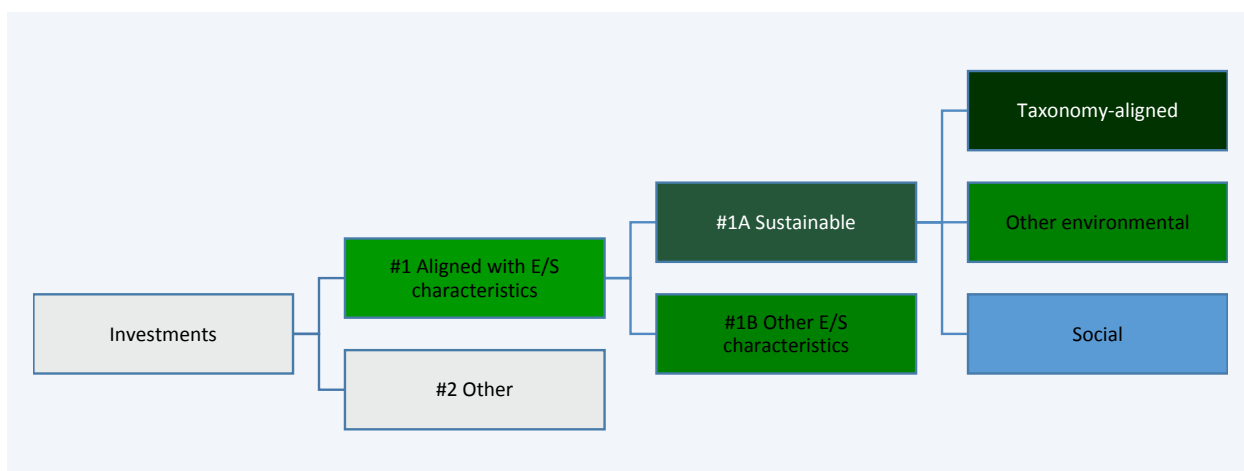

#1 Aligned with E/S characteristics includes the investments of the financial product used to attain the environmental or social characteristics promoted by the financial product.

#2 Other includes the remaining investments of the financial product which are neither aligned with the environmental or social characteristics, nor are qualified as sustainable investments.

The category **#1 Aligned with E/S characteristics** covers:

- The sub-category **#1A Sustainable** covers sustainable investments with environmental or social objectives.
- The sub-category **#1B Other E/S characteristics** covers investments aligned with the environmental or social characteristics that do not qualify as sustainable investments.

- How does the use of derivatives attain the environmental or social characteristics promoted by the financial product?

Not applicable



To what minimum extent are sustainable investments with an environmental objective aligned with the EU Taxonomy?

The Sub-Fund's Investment Manager does not commit to a minimum share of sustainable investments with an environmental objective aligned with the EU Taxonomy. The overall sustainable investment share may also include investments with an environmental objective in economic activities that qualify as environmentally sustainable under the EU Taxonomy.

- Does the financial product invest in fossil gas and/or nuclear energy related activities that comply with the EU Taxonomy¹?

- Yes:
- In fossil gas
 - In nuclear energy
- No

The Sub-Fund does not pursue any investments in fossil gas and/or nuclear energy related activities that comply with the EU Taxonomy. Nevertheless, as result of this investment strategy, investments may occur in corporates which are also active in these activities. Further information will be provided as part of the annual reporting, if relevant.

The two graphs below show in green the minimum percentage of investments that are aligned with the EU Taxonomy. As there is no appropriate methodology to determine the Taxonomy-alignment of sovereign bonds*, the first graph shows the Taxonomy-alignment in relation to all the investments of the financial product including sovereign bonds, while the second graph shows the Taxonomy-alignment only in relation to the investments of the financial product other than sovereign bonds.

1. Taxonomy-alignment of investments including sovereign bonds*

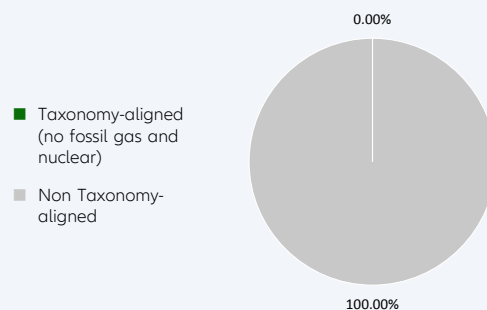

2. Taxonomy-alignment of investments excluding sovereign bonds*

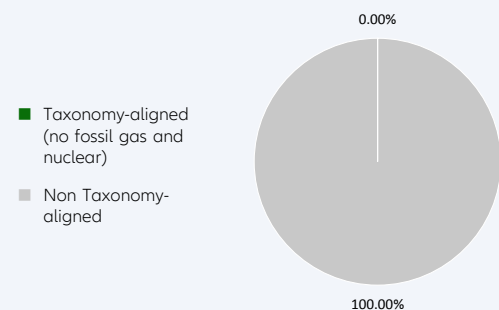

This graph represents X% of the total investments. It is noted that – due to the fact that this Sub-Fund does not provide for a minimum quota of taxonomy-aligned investments – this graph does not generate any additional added value compared to the left-hand graph.

* For the purpose of these graphs, 'sovereign bonds' consist of all sovereign exposures

- What is the minimum share of investments in transitional and enabling activities?

The Sub-Fund's Investment Manager does not commit to a split of minimum taxonomy alignment into transitional, enabling activities and own performance.

Taxonomy-aligned activities are expressed as a share of:

- **turnover** reflecting the share of revenue from green activities of investee companies
- **capital expenditure** (CapEx) showing the green investments made by investee companies, e.g. for a transition to a green economy.
- **operational expenditure** (OpEx) reflecting green operational activities of investee companies.

Enabling activities directly enable other activities to make a substantial contribution to an environmental objective.

Transitional activities are activities for which low-carbon alternatives are not yet available

¹ Fossil gas and/or nuclear related activities will only comply with the EU Taxonomy where they contribute to limiting climate change ("climate change mitigation") and do not significantly harm any EU Taxonomy objective - see explanatory note in the left hand margin. The full criteria for fossil gas and nuclear energy economic activities that comply with the EU Taxonomy are laid down in Commission Delegated Regulation (EU) 2022/1214.

and among others have greenhouse gas emission levels corresponding to the best performance.



What is the minimum share of sustainable investments with an environmental objective that are not aligned with the EU Taxonomy?

Taxonomy-aligned investments are considered a sub-category of Sustainable Investments. If an investment is not Taxonomy-aligned since the activity is not yet covered under the EU Taxonomy or the positive contribution is not substantial enough to comply with the Taxonomy technical screening criteria, the investment can still be considered an environmentally Sustainable Investment provided it complies with all criteria. The Investment Manager does not commit to a minimum share of environmentally Sustainable Investments that are not aligned with the EU Taxonomy. The overall sustainable investment share may also include investments with an environmental objective in economic activities that do not qualify as environmentally sustainable under the EU Taxonomy, and while the Sub-Fund cannot commit to a minimum share of environmentally or socially sustainable investments, such investments may be freely allocated to within the Sub-Fund aggregated sustainable investment commitment disclosed (min 20%).



are sustainable investments with an environmental objective that do not take into account the criteria for environmentally sustainable economic activities under the EU Taxonomy.



What is the minimum share of socially sustainable investments?

The Investment Manager defines Sustainable Investments based on internal research, which uses, among others, the UN Sustainable Development Goals (SDGs), as well as the objectives of the EU Taxonomy as reference frameworks. The Investment Manager does not commit to a minimum share of socially Sustainable Investments, as the SDGs contain environmental as well as social objectives. The overall sustainable investment share may also include investments with a social objective,, and while the Sub-Fund cannot commit to a minimum share of environmentally or socially sustainable investments, such investments may be freely allocated to within the Sub-Fund aggregated sustainable investment commitment disclosed (min 20%).



What investments are included under “#2 Other”, what is their purpose and are there any minimum environmental or social safeguards?

Under “#2 Other” investments into cash, Target Funds, or derivatives can be included. Derivatives might be used for efficient portfolio management (including risk hedging) and/or investment purposes, and Target Funds to benefit from a specific strategy. For those investments no environmental or social safeguards are applied.



Is a specific index designated as a reference benchmark to determine whether this financial product is aligned with the environmental and/or social characteristics that it promotes?

No reference benchmark has been designated for the purpose of attaining the environmental and/or social characteristics promoted by the Sub-Fund.

Reference benchmarks are indexes to measure whether the financial product attains the environmental or social characteristics that they promote.

- How is the reference benchmark continuously aligned with each of the environmental or social characteristics promoted by the financial product?

Not applicable

- How is the alignment of the investment strategy with the methodology of the index ensured on a continuous basis?

Not applicable

- How does the designated index differ from a relevant broad market index?
Not applicable
- Where can the methodology used for the calculation of the designated index be found?
Not applicable



Where can I find more product specific information online?

More product-specific information can be found on the website: <https://regulatory.allianzgi.com/SFDR>

Template pre-contractual disclosure for the financial products referred to in Article 8, paragraphs 1, 2 and 2a, of Regulation (EU) 2019/2088 and Article 6, first paragraph, of Regulation (EU) 2020/852

Product name:

Allianz Positive Change

Legal entity identifier: 529900BL3ET622OAUC93

Environmental and/or social characteristics

Sustainable investment means an investment in an economic activity that contributes to an environmental or social objective, provided that the investment does not significantly harm any environmental or social objective and that the investee companies follow good governance practices.

The EU Taxonomy is a classification system laid down in Regulation (EU) 2020/852, establishing a list of environmentally sustainable economic activities. That Regulation does not include a list of socially sustainable economic activities. Sustainable investments with an environmental objective might be aligned with the Taxonomy or not.

Does this financial product have a sustainable investment objective?	
<input checked="" type="radio"/> <input checked="" type="radio"/> Yes	<input checked="" type="radio"/> <input type="radio"/> No
<input type="checkbox"/> It will make a minimum of sustainable investments with an environmental objective: ___% <input type="checkbox"/> in economic activities that qualify as environmentally sustainable under the EU Taxonomy <input type="checkbox"/> in economic activities that do not qualify as environmentally sustainable under the EU Taxonomy	<input checked="" type="checkbox"/> It promotes Environmental/Social (E/S) characteristics and while it does not have as its objective a sustainable investment, it will have a minimum proportion of 50.00% of sustainable investments <input checked="" type="checkbox"/> with an environmental objective in economic activities that qualify as environmentally sustainable under the EU Taxonomy <input checked="" type="checkbox"/> with an environmental objective in economic activities that do not qualify as environmentally sustainable under the EU Taxonomy <input checked="" type="checkbox"/> with a social objective
<input type="checkbox"/> It will make a minimum of sustainable investments with a social objective ___%	<input type="checkbox"/> It promotes E/S characteristics, but will not make any sustainable investments



What environmental and/or social characteristics are promoted by this financial product?

Allianz Positive Change's (the "Sub-Fund") invests in securities of companies providing products or services which contribute to environmental or social objectives, as defined by the UN Sustainable Development Goals (SDGs) or the EU Taxonomy objectives, which are also related to the SDGs. The contribution is measured according to the Sustainable Investment methodology.

In addition, sustainable minimum exclusion criteria apply.

No reference benchmark has been designated for the purpose of attaining the environmental and/or social characteristics promoted by the Sub-Fund.

What sustainability indicators are used to measure the attainment of each of the environmental or social characteristics promoted by this financial product?

To measure the attainment of the Sub-Fund's sustainable investment objective the following sustainability indicators are used and reported on, at the fiscal year end:

- The actual Sustainable Investment share – which is based on SDGs or EU Taxonomy objectives
- Principle Adverse Impacts (PAIs) of investment decisions on sustainability factors are considered through the application of exclusion criteria.

Sustainability indicators measure how the environmental or social characteristics promoted by the financial product are attained.

- **What are the objectives of the sustainable investments that the financial product partially intends to make and how does the sustainable investment contribute to such objectives?**

Sustainable investments contribute to environmental and/or social objectives, for which the Investment Manager uses as reference frameworks, among others, the UN Sustainable Development Goals (SDGs), as well as the objectives of the EU Taxonomy:

1. Climate Change Mitigation
2. Climate Change Adaptation
3. Sustainable Use and Protection of Water and Marine Resources
4. Transition to a Circular Economy
5. Pollution Prevention and Control
6. Protection and Restoration of Biodiversity and Ecosystems

The assessment of the positive contribution to the environmental or social objectives is based on a proprietary framework which combines quantitative elements with qualitative inputs from internal research. The methodology applies first a quantitative breakdown of a securities issuer into its business activities. The qualitative element of the framework is an assessment if business activities contribute positively to an environmental or a social objective.

To calculate the positive contribution on the Sub-Fund level the revenue share of each issuer attributable to business activities contributing to environmental and/or social objectives is considered provided the issuer is satisfying the Do No Significant Harm (“DNSH”) and Good Governance principles, and an asset-weighted aggregation is performed as a second step. Moreover, for certain types of securities, which finance specific projects contributing to environmental or social objectives the overall investment is considered to contribute to environmental and/or social objectives, but also for these a DNSH as well as a Good Governance check for issuers is performed.

- **How do the sustainable investments that the financial product partially intends to make, not cause significant harm to any environmental or social sustainable investment objective?**

In order to ensure that Sustainable Investments do not significantly harm any other environmental and/or social objective, the Investment Manager is leveraging the PAI indicators, whereby significance thresholds have been defined to identify significantly harmful issuers. Issuers not meeting the significance threshold can be engaged for a limited time period to remediate the adverse impact. Otherwise, if the issuer does not meet the defined significance thresholds twice subsequently or in case of a failed engagement, it does not pass the DNSH assessment. Investments in securities of issuers which do not pass the DNSH assessment are not counted as sustainable investments.

- *How have the indicators for adverse impacts on sustainability factors been taken into account?*

All mandatory PAI indicators are considered either as part of the application of the exclusion criteria or through thresholds on a sectorial or absolute basis. Significance thresholds have been defined and they refer to qualitative or quantitative criteria.

Recognizing the lack of data coverage for some of the PAI indicators equivalent data points are used to assess PAI indicators when applying the DNSH assessment, when relevant, for the following indicators for corporates: share of non-renewable energy consumption and production, activities negatively affecting biodiversity-sensitive areas, emissions to water, lack of processes and compliance mechanisms to monitor compliance with UNGC principles and OECD Guidelines for Multinational Enterprises; for sovereigns: GHG Intensity and investee countries subject to social violations. In case of securities which finance specific projects contributing to environmental or social objectives equivalent data at project level might be used to ensure that Sustainable Investments do not significantly harm any other environmental and/or social objective. The Investment Manager will strive to increase data coverage for PAI indicators with low data coverage by engaging with issuers and data providers. The Investment Manager will regularly evaluate whether the availability of data has increased sufficiently to potentially include assessment of such data in the investment process.

- *How are the sustainable investments aligned with the OECD Guidelines for Multinational Enterprises and the UN Guiding Principles on Business and Human Rights? Details:*

The Investment Manager’s sustainable minimum exclusion list screens out companies based on their involvement in controversial practices against international norms. The core normative framework consists of the Principles of the UN Global Compact, the OECD Guidelines for Multinational Enterprises

Principal adverse impacts are the most significant negative impacts of investment decisions on sustainability factors relating to environmental, social and employee matters, respect for human rights, anti-corruption and anti-bribery matters.

and the UN Guiding Principles for Business and Human Rights. Securities issued by companies having a severe violation of these frameworks will be restricted from the investment universe.

The EU Taxonomy sets out a “do not significant harm” principle by which Taxonomy-aligned investments should not significantly harm EU Taxonomy objectives and is accompanied by specific EU criteria.

The “do not significant harm” principle applies only to those investments underlying the financial product that take into account the EU criteria for environmentally sustainable economic activities. The investments underlying the remaining portion of this financial product do not take into account the EU criteria for environmentally sustainable economic activities.

Any other sustainable investments must also not significantly harm any environmental or social objectives.



Does this financial product consider principal adverse impacts on sustainability factors?

Yes

No

The Management Company has joined the Net Zero Asset Manager Initiative and considers PAI indicators through stewardship including engagement, both are relevant to mitigate potential adverse impact as a company.

Due to the commitment to the Net Zero Asset Manager Initiative, the Management Company aims to reduce greenhouse gas emissions in partnership with asset owner clients on decarbonisation goals, consistent with an ambition to reach net zero emission by 2050 or sooner across all assets under management. As part of this objective the Management Company will set an interim target for the proportion of assets to be managed in line with the attainment of net zero emissions by 2050 or sooner.

The Sub-Fund’s Investment Manager considers PAI indicators regarding greenhouse gas emission, biodiversity, water, waste as well as social and employee matters for corporate issuers, and, where relevant, the freedom house index is applied to investments in sovereigns. PAI indicators are considered within the Investment Manager’s investment process through the means of exclusions as described in the “binding elements” section of the Sub-Fund.

The data coverage for the data required for the PAI indicators is heterogenous. The data coverage related to biodiversity, water and waste is low and the related PAI indicators are considered through exclusion of securities issued by companies having a severe violation / breach of principles and guidelines such as the Principles of the United Nations Global Compact, the OECD Guidelines for Multinational Enterprises, and the United Nations Guiding Principles for Business and Human Rights on the grounds of problematic practices around human rights, labour rights, environment, and corruption issues. Therefore, the Investment Manager will strive to increase data coverage for PAI indicators with low data coverage. The Investment Manager will regularly evaluate whether the availability of data has increased sufficiently to potentially include assessment of such data in the investment process.

Additionally, PAI indicators are considered as part of the requirement of the Sub-Fund to invest 50% into Sustainable Investments. PAI indicators are used as part of the DNSH assessment. Investments in securities of issuers who do not pass the DNSH assessment are not counted as sustainable investments.

The following PAI indicators are considered:

Applicable to corporate issuers

- GHG Emissions
- Carbon footprint
- GHG Intensity of investee companies
- Exposure to companies active in the fossil fuel sector
- Share of non-renewable energy consumption and production
- Energy consumption intensity per high impact climate sector
- Activities negatively affecting biodiversity-sensitive areas
- Emissions to water
- Hazardous waste ratio
- Violation of UN Global compact principles

- Lack of processes and compliance mechanisms to monitor compliance with UN Global Compact principles
- Unadjusted gender pay gap
- Board gender diversity
- Exposure to controversial weapons

Applicable to sovereign and supranational issuers

- GHG Intensity
- Investee countries subject to social violations

The information on the PAI indicators will be available in the end-year report of the Sub-Fund.



What investment strategy does this financial product follow?

The investment strategy guides investment decisions based on factors such as investment objectives and risk tolerance.

Allianz Positive Change's investment objective is to invest in global Equity Markets in accordance with the SDG-Aligned Strategy with a focus on companies with an engagement in one or more United Nations' SDGs, and hence create positive outcomes for environment and society.

The Sub-Fund invests in Equities of companies which engage in one or more SDGs and offer products and services across the themes of affordable healthcare, education, energy transition, food security, financial inclusion, water and waste management as targeted by the SDG No. 1, 2, 3, 4, 5, 6, 7, 8, 9, 10, 11, 12, 13, 14, 15, 16 and 17.

The Sub-Fund's general investment approach (Sub-Fund's applicable General Asset Class Principles in combination with its individual investment restrictions) is described in the prospectus.

● What are the binding elements of the investment strategy used to select the investments to attain each of the environmental or social characteristics promoted by this financial product?

The binding elements are:

- Minimum 50% of the Sub-Fund assets' weighted average shall result from revenue generated from issuers' activities that facilitate the achievement of one or more SDG or EU Taxonomy objectives as measured according to the Sustainable Investment methodology.
- For at least 80% of the Sub-Fund portfolio, the respective issuer shall have a minimum share of 20% Sustainable Investments. Cash and derivatives are excluded from the aforesaid thresholds.
- Application of the following sustainable minimum exclusion criteria for direct investments:
 - securities issued by companies having a severe violation / breach of principles and guidelines such as the Principles of the United Nations Global Compact, the OECD Guidelines for Multinational Enterprises, and the United Nations Guiding Principles for Business and Human Rights on the grounds of problematic practices around human rights, labour rights, environment, and corruption issues,
 - securities issued by companies involved in controversial weapons (anti-personnel mines, cluster munitions, chemical weapons, biological weapons, depleted uranium, white phosphorus, and nuclear weapons),
 - securities issued by companies that derive more than 10% of their revenues from weapons, military equipment, and services,
 - securities issued by companies that derive more than 10% of their revenue from thermal coal extraction,
 - securities issued by utility companies that generate more than 20% of their revenues from coal,
 - securities issued by companies involved in the production of tobacco, and securities issued by companies involved in the distribution of tobacco with more than 5% of their revenues.

Direct investments in sovereign issuers with an insufficient freedom house index score are excluded.

The sustainable minimum exclusion criteria are based on information from an external data provider and coded in pre- and post-trade compliance. The review is performed at least half yearly.

- **What is the committed minimum rate to reduce the scope of the investments considered prior to the application of that investment strategy?**

The Sub-Fund does not commit to reduce the scope of the investments by a certain minimum rate.

- **What is the policy to assess good governance practices of the investee companies?**

Good governance principles are considered by screening out companies based on their involvement in controversies around international norms corresponding to the four good governance practices: sound management structures, employee relations, remuneration of staff and tax compliance. Companies having a severe violation in either of those areas will not be investible. For certain cases, flagged issuers shall be on a watch list. These companies will appear on this watch list when the Investment Manager believes that engagement may lead to improvements or when the company is assessed to take remedial actions. Companies on the watch list remain investible unless the Investment Manager believes that the engagement or the remedial actions of the company does not lead to the desired remedy of the severe controversy.

In addition, the Sub-Fund's Investment Manager is committed to actively encourage open dialogues with investee companies on corporate governance, proxy voting and broader sustainability issues in advance of shareholder meetings (regularly for direct investments in shares). The Sub-Fund's Investment Manager's approach to proxy voting and company engagement is set out in the Management Company's Stewardship Statement.

Good governance practices include sound management structures, employee relations, remuneration of staff and tax compliance.



What is the asset allocation planned for this financial product?

Asset allocation describes the share of investments in specific assets.

Min. 80% of the Sub-Funds' assets (excluding cash, and derivatives) are used to meet the environmental or social characteristics promoted by this Sub-Fund. A low portion of the Sub-Fund might contain assets which do not promote environmental or social characteristics. Example of such instruments are derivatives, cash and deposits, some Target Funds and investment with temporarily divergent or absent environmental, social, or good governance qualifications. The Sub-Fund invest primarily into securities which offer products and services to facilitate the achievements of the SDGs. Min. 50% of the Sub-Funds' assets will be invested in Sustainable Investments. The minimum percentage of investments that are aligned with the EU Taxonomy is 0.01%. The Sub-Fund's Investment Manager does not commit to a minimum share of environmentally Sustainable Investments that are not aligned with the EU Taxonomy. The Sub-Fund's Investment Manager does not commit to a minimum share of socially sustainable investments. While the Sub-Fund cannot commit to a minimum share of environmentally or socially sustainable investments, such investments may be freely allocated to within the Sub-Fund aggregated sustainable investment commitment disclosed (min. 50%).

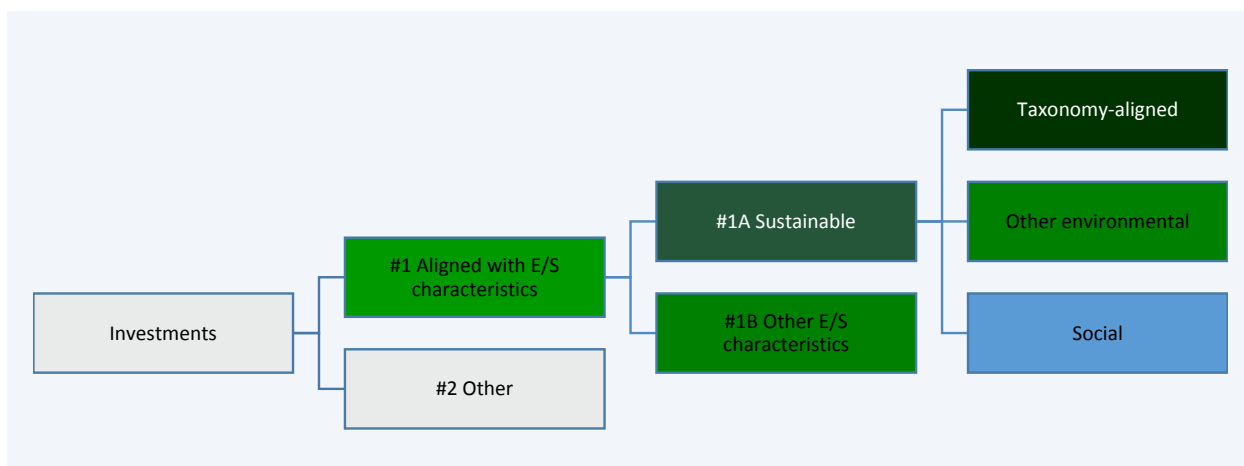

#1 Aligned with E/S characteristics includes the investments of the financial product used to attain the environmental or social characteristics promoted by the financial product.

#2 Other includes the remaining investments of the financial product which are neither aligned with the environmental or social characteristics, nor are qualified as sustainable investments.

The category **#1 Aligned with E/S characteristics** covers:

- The sub-category **#1A Sustainable** covers sustainable investments with environmental or social objectives.
- The sub-category **#1B Other E/S characteristics** covers investments aligned with the environmental or social characteristics that do not qualify as sustainable investments.

- **How does the use of derivatives attain the environmental or social characteristics promoted by the financial product?**

Not applicable



To what minimum extent are sustainable investments with an environmental objective aligned with the EU Taxonomy?

The Taxonomy-aligned investments include debt and/or equity in environmentally sustainable economic activities aligned with the EU-Taxonomy. The minimum percentage of investments that are aligned with the EU Taxonomy is 0.01%. Taxonomy-aligned data is provided by an external data provider. The Investment Manager has assessed the quality of such data. The data will not be subject to an assurance provided by auditors or a review by third parties. The data will not reflect any data in government bonds. As of today, there is no recognized methodology available to determine the proportion of Taxonomy-aligned activities when investing in government bonds.

Taxonomy-aligned activities in this disclosure are based on share of turnover. Pre-contractual figures use turnover as its financial metric as a default in line with the regulatory requirements and based on the fact that complete, verifiable or up-to date data for CAPEX and/or OPEX as financial metric is even less available.

Taxonomy-aligned data is only in rare cases data reported by companies in accordance with the EU Taxonomy. The data provider has derived Taxonomy-aligned data from other available equivalent public data.

- **Does the financial product invest in fossil gas and/or nuclear energy related activities that comply with the EU Taxonomy ^{1?}**

Yes:

In fossil gas In nuclear energy

No

The Sub-Fund does not pursue any investments in fossil gas and/or nuclear energy related activities that comply with the EU Taxonomy. Nevertheless, as result of this investment strategy, investments may occur in corporates which are also active in these activities. Further information will be provided as part of the annual reporting, if relevant.

The two graphs below show in green the minimum percentage of investments that are aligned with the EU Taxonomy. As there is no appropriate methodology to determine the Taxonomy-alignment of sovereign bonds, the first graph shows the Taxonomy-alignment in relation to all the investments of the financial product including sovereign bonds, while the second graph shows the Taxonomy-alignment only in relation to the investments of the financial product other than sovereign bonds.*

1. Taxonomy-alignment of investments including sovereign bonds*

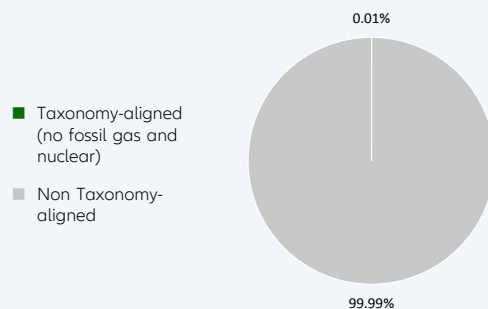

2. Taxonomy-alignment of investments excluding sovereign bonds*

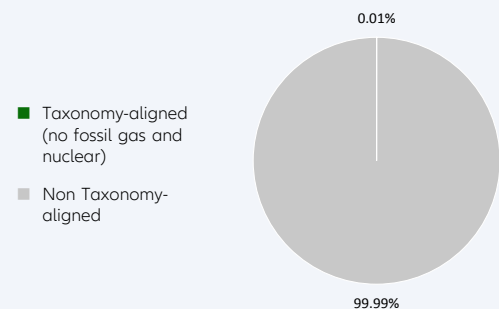

This graph represents X% of the total investments. It is noted that this Sub-Fund does not provide for a binding minimum quota for investments in sovereign bonds. Therefore, this Sub-Fund may have (but must not have) an exposure to sovereign bonds. In the absence of a binding minimum quota for investments in sovereign

Taxonomy-aligned activities are expressed as a share of:
 - **turnover** reflecting the share of revenue from green activities of investee companies
 - **capital expenditure (CapEx)** showing the green investments made by investee companies, e.g. for a transition to a green economy.
 - **operational expenditure (OpEx)** reflecting green operational activities of investee companies.

¹ Fossil gas and/or nuclear related activities will only comply with the EU Taxonomy where they contribute to limiting climate change ("climate change mitigation") and do not significantly harm any EU Taxonomy objective - see explanatory note in the left hand margin. The full criteria for fossil gas and nuclear energy economic activities that comply with the EU Taxonomy are laid down in Commission Delegated Regulation (EU) 2022/1214.

bonds, this graph does not generate any additional added value compared to the left-hand graph.

* For the purpose of these graphs, 'sovereign bonds' consist of all sovereign exposures

Enabling activities directly enable other activities to make a substantial contribution to an environmental objective.

Transitional activities are activities for which low-carbon alternatives are not yet available and among others have greenhouse gas emission levels corresponding to the best performance.

● What is the minimum share of investments in transitional and enabling activities?

The Sub-Fund's Investment Manager does not commit to a split of minimum taxonomy alignment into transitional, enabling activities and own performance.



What is the minimum share of sustainable investments with an environmental objective that are not aligned with the EU Taxonomy?

Taxonomy-aligned investments are considered a sub-category of Sustainable Investments. If an investment is not Taxonomy-aligned since the activity is not yet covered under the EU Taxonomy or the positive contribution is not substantial enough to comply with the Taxonomy technical screening criteria, the investment can still be considered an environmentally Sustainable Investment provided it complies with all criteria. The Investment Manager does not commit to a minimum share of environmentally Sustainable Investments that are not aligned with the EU Taxonomy. The overall sustainable investment share may also include investments with an environmental objective in economic activities that do not qualify as environmentally sustainable under the EU Taxonomy, and while the Sub-Fund cannot commit to a minimum share of environmentally or socially sustainable investments, such investments may be freely allocated to within the Sub-Fund aggregated sustainable investment commitment disclosed (min. 50%).



are sustainable investments with an environmental objective that **do not take into account the criteria** for environmentally sustainable economic activities under the EU Taxonomy.



What is the minimum share of socially sustainable investments?

The Investment Manager defines Sustainable Investments based on internal research, which uses, among others, the UN Sustainable Development Goals (SDGs), as well as the objectives of the EU Taxonomy as reference frameworks. The Investment Manager does not commit to a minimum share of socially Sustainable Investments, as the SDGs contain environmental as well as social objectives. The overall sustainable investment share may also include investments with a social objective, and while the Sub-Fund cannot commit to a minimum share of environmentally or socially sustainable investments, such investments may be freely allocated to within the Sub-Fund aggregated sustainable investment commitment disclosed (min. 50%).



What investments are included under “#2 Other”, what is their purpose and are there any minimum environmental or social safeguards?

Under “#2 Other” investments into cash, Target Funds, or derivatives can be included. Derivatives might be used for efficient portfolio management (including risk hedging) and/or investment purposes, and Target Funds to benefit from a specific strategy. For those investments no environmental or social safeguards are applied.



Is a specific index designated as a reference benchmark to determine whether this financial product is aligned with the environmental and/or social characteristics that it promotes?

No reference benchmark has been designated for the purpose of attaining the environmental and/or social characteristics promoted by the Sub-Fund.

Reference benchmarks are indexes to measure whether the financial product attains the environmental or social characteristics that they promote.

- **How is the reference benchmark continuously aligned with each of the environmental or social characteristics promoted by the financial product?**
Not applicable
- **How is the alignment of the investment strategy with the methodology of the index ensured on a continuous basis?**
Not applicable
- **How does the designated index differ from a relevant broad market index?**
Not applicable
- **Where can the methodology used for the calculation of the designated index be found?**
Not applicable



Where can I find more product specific information online?

More product-specific information can be found on the website: <https://regulatory.allianzgi.com/SFDR>

Template pre-contractual disclosure for the financial products referred to in Article 9, paragraphs 1 to 4a, of Regulation (EU) 2019/2088 and Article 5, first paragraph, of Regulation (EU) 2020/852

Product name:

Allianz SDG Euro Credit

Legal entity identifier: 529900IA5IQGQKTAYO36

Sustainable investment objective

Sustainable investment means an investment in an economic activity that contributes to an environmental or social objective, provided that the investment does not significantly harm any environmental or social objective and that the investee companies follow good governance practices.

The EU Taxonomy is a classification system laid down in Regulation (EU) 2020/852, establishing a list of **environmentally sustainable economic activities**. That Regulation does not include a list of socially sustainable economic activities. Sustainable investments with an environmental objective might be aligned with the Taxonomy or not.

Does this financial product have a sustainable investment objective?	
<input checked="" type="radio"/> <input checked="" type="radio"/> Yes	<input type="radio"/> <input type="radio"/> No
<input checked="" type="checkbox"/> It will make a minimum of sustainable investments with an environmental objective: 40.00%	<input type="checkbox"/> It promotes Environmental/Social (E/S) characteristics and while it does not have as its objective a sustainable investment, it will have a minimum proportion of ___% of sustainable investments
<input checked="" type="checkbox"/> in economic activities that qualify as environmentally sustainable under the EU Taxonomy	<input type="checkbox"/> with an environmental objective in economic activities that qualify as environmentally sustainable under the EU Taxonomy
<input checked="" type="checkbox"/> in economic activities that do not qualify as environmentally sustainable under the EU Taxonomy	<input type="checkbox"/> with an environmental objective in economic activities that do not qualify as environmentally sustainable under the EU Taxonomy
<input checked="" type="checkbox"/> It will make a minimum of sustainable investments with a social objective 5.00%	<input type="checkbox"/> with a social objective
	<input type="checkbox"/> It promotes E/S characteristics, but will not make any sustainable investments

The Sub-Fund will invest more than 80% of its assets in Sustainable Investments and this commitment is achieved through environmentally or socially sustainable investments.



What is the sustainable investment objective of this financial product?

Allianz SDG Euro Credit (the "Sub-Fund") invests in securities of companies providing products or services which contribute to environmental or social objectives, as defined by the UN Sustainable Development Goals (SDGs) or the EU Taxonomy objectives, which are also related to the SDGs. The contribution is measured according to the Sustainable Investment methodology.

In addition, sustainable minimum exclusion criteria for direct investments apply.

No reference benchmark has been designated for the purpose of meeting the sustainable investment objective.

● What sustainability indicators are used to measure the attainment of the sustainable investment objective of this financial product?

To measure the attainment of the Sub-Fund's sustainable investment objective the following sustainability indicators are used and reported on, at the fiscal year end:

- The actual Sustainable Investment share – which is based on SDGs or EU Taxonomy objectives
- Principle Adverse Impacts (PAIs) of investment decisions on sustainability factors are considered through the application of exclusion criteria.

The Sustainable Investment share is based on the following methodology: Sustainable investments contribute to environmental and/or social objectives, for which the Investment Managers uses as reference

frameworks, among others, the UN Sustainable Development Goals (SDGs), as well as the objectives of the EU Taxonomy:

1. Climate Change Mitigation
2. Climate Change Adaptation
3. Sustainable Use and Protection of Water and Marine Resources
4. Transition to a Circular Economy
5. Pollution Prevention and Control
6. Protection and Restoration of Biodiversity and Ecosystems

The assessment of the positive contribution to the environmental or social objectives is based on a proprietary framework which combines quantitative elements with qualitative inputs from internal research. The methodology applies first a quantitative breakdown of a securities issuer into its business activities. The qualitative element of the framework is an assessment if business activities contribute positively to an environmental or a social objective. To calculate the positive contribution on the Sub-Fund level the revenue share of each issuer attributable to business activities contributing to environmental and/or social objectives is considered provided the issuer is satisfying the Do No Significant Harm (“DNSH”) and Good Governance principles, and an asset-weighted aggregation is performed as a second step. Moreover, for certain types of securities, which finance specific projects contributing to environmental or social objectives the overall investment is considered to contribute to environmental and/or social objectives, but also for these a DNSH as well as a Good Governance check for issuers is performed.

● **How do sustainable investments not cause significant harm to any environmental or social sustainable investment objective?**

In order to ensure that Sustainable Investments do not significantly harm any other environmental and/or social objective, the Investment Manager is leveraging the PAI indicators, whereby significance thresholds have been defined to identify significantly harmful issuers. Issuers not meeting the significance threshold can be engaged for a limited time period to remediate the adverse impact. Otherwise, if the issuer does not meet the defined significance thresholds twice subsequently or in case of a failed engagement, it does not pass the DNSH assessment. Investments in securities of issuers which do not pass the DNSH assessment are not counted as sustainable investments.

● *How have the indicators for adverse impacts on sustainability factors been taken into account?*

All mandatory PAI indicators are considered either as part of the application of the exclusion criteria or through thresholds on a sectorial or absolute basis. Significance thresholds have been defined and they refer to qualitative or quantitative criteria.

Recognizing the lack of data coverage for some of the PAI indicators equivalent data points are used to assess PAI indicators when applying the DNSH assessment, when relevant, for the following indicators for corporates: share of non-renewable energy consumption and production, activities negatively affecting biodiversity-sensitive areas, emissions to water, lack of processes and compliance mechanisms to monitor compliance with UNGC principles and OECD Guidelines for Multinational Enterprises; for sovereigns: GHG Intensity and investee countries subject to social violations. In case of securities which finance specific projects contributing to environmental or social objectives equivalent data at project level might be used to ensure that Sustainable Investments do not significantly harm any other environmental and/or social objective. The Investment Manager will strive to increase data coverage for PAI indicators with low data coverage by engaging with issuers and data providers. The Investment Manager will regularly evaluate whether the availability of data has increased sufficiently to potentially include assessment of such data in the investment process.

● *How are the sustainable investments aligned with the OECD Guidelines for Multinational Enterprises and the UN Guiding Principles on Business and Human Rights? Details:*

The Investment Manager’s sustainable minimum exclusion list screens out companies based on their involvement in controversial practices against international norms. The core normative framework consists of the Principles of the UN Global Compact, the OECD Guidelines for Multinational Enterprises and the UN Guiding Principles for Business and Human Rights. Securities issued by companies having a severe violation of these frameworks will be restricted from the investment universe.

Principal adverse impacts are the most significant negative impacts of investment decisions on sustainability factors relating to environmental, social and employee matters, respect for human rights, anti-corruption and anti-bribery matters.



Does this financial product consider principal adverse impacts on sustainability factors?

Yes

No

The Management Company has joined the Net Zero Asset Manager Initiative and considers PAI indicators through stewardship including engagement, both are relevant to mitigate potential adverse impact as a company.

Due to the commitment to the Net Zero Asset Manager Initiative, the Management Company aims to reduce greenhouse gas emissions in partnership with asset owner clients on decarbonisation goals, consistent with an ambition to reach net zero emission by 2050 or sooner across all assets under management. As part of this objective the Management Company will set an interim target for the proportion of assets to be managed in line with the attainment of net zero emissions by 2050 or sooner.

The Sub-Fund's Investment Manager considers PAI indicators regarding greenhouse gas emission, biodiversity, water, waste as well as social and employee matters for corporate issuers, and, where relevant, the freedom house index is applied to investments in sovereigns. PAI indicators are considered within the Investment Manager's investment process through the means of exclusions as described in the "binding elements" section of the Sub-Fund.

The data coverage for the data required for the PAI indicators is heterogenous. The data coverage related to biodiversity, water and waste is low and the related PAI indicators are considered through exclusion of securities issued by companies having a severe violation / breach of principles and guidelines such as the Principles of the United Nations Global Compact, the OECD Guidelines for Multinational Enterprises, and the United Nations Guiding Principles for Business and Human Rights on the grounds of problematic practices around human rights, labour rights, environment, and corruption issues. Therefore, the Investment Manager will strive to increase data coverage for PAI indicators with low data coverage. The Investment Manager will regularly evaluate whether the availability of data has increased sufficiently to potentially include assessment of such data in the investment process.

Additionally, PAI indicators are considered as part of the requirement of the Sub-Fund to invest more than 80% into Sustainable Investments. PAI indicators are used as part of the DNSH assessment. Investments in securities of issuers who do not pass the DNSH assessment are not counted as sustainable investments.

The following PAI indicators are considered:

Applicable to corporate issuers

- GHG Emissions
- Carbon footprint
- GHG Intensity of investee companies
- Exposure to companies active in the fossil fuel sector
- Share of non-renewable energy consumption and production
- Energy consumption intensity per high impact climate sector
- Activities negatively affecting biodiversity-sensitive areas
- Emissions to water
- Hazardous waste ratio
- Violation of UN Global compact principles
- Lack of processes and compliance mechanisms to monitor compliance with UN Global Compact principles
- Unadjusted gender pay gap
- Board gender diversity
- Exposure to controversial weapons

Applicable to sovereign and supranational issuers

- GHG Intensity
- Investee countries subject to social violations

The information on the PAI indicators will be available in the end-year report of the Sub-Fund.



What investment strategy does this financial product follow?

The investment strategy guides investment decisions based on factors such as investment objectives and risk tolerance.

Allianz SDG Euro Credit's investment objective is to invest in Debt Securities with Investment Grade denominated in Euro of Eurozone or OECD Bond in accordance with the SDG Aligned Strategy Type A with a focus on companies with an engagement in one or more United Nations' SDGs and/ or on securities supporting climate-related or social projects, and hence create positive outcomes for environment and society.

The Sub-Fund invests in Debt Securities of companies which offer products and services across themes. Examples of such themes and topics include, but are not limited to, affordable healthcare, education, energy transition, food security, financial inclusion, water, and waste management as targeted by the SDGs, as well as in Green Bonds, Social Bonds, Sustainable Bonds and Sustainability-Linked bonds.

The assessment of the contribution to the specified SDGs is based in particular on qualitative and quantitative analysis using internal sensitivity scores and revenue attribution as sustainability indicators.

In case of certain Debt Securities which have been issued to support specific environmental, social or sustainable projects, the respective bond proceeds and/or selection of defined SDGs-related Key Performance Indicators (KPIs) indicated in the respective applicable Green Bond Principles/ Social Bond Principles/ Sustainability-Linked Bond Principles – instead of the revenue of the respective Debt Security's issuer – are accounted for the assessment of the contribution to the SDGs.

The Sub-Fund's general investment approach used to achieve the Sub-Fund's investment objective (Sub-Fund's applicable General Asset Class Principles in combination with the Sub-Fund's individual investment restrictions) is described in the prospectus.

● What are the binding elements of the investment strategy used to select the investments to attain the sustainable investment objective?

The investment strategy adheres to the following binding elements to attain the Sustainable Investment objective:

- Minimum 80% of the Sub-Fund assets' weighted average shall result from revenue generated from issuers' activities that facilitate the achievement of one or more SDG or EU Taxonomy objectives as measured according to the Sustainable Investment methodology.
- For at least 80% of Sub-Fund portfolio, the respective issuer shall have a minimum share of 20% Sustainable Investments, for the remaining 20% (or less) of the Sub-Fund portfolio, each respective issuer shall have a minimum share of at least 5% Sustainable Investment. Cash and derivatives are excluded from these thresholds.

If the Investment Manager acquires a use of proceed security, which finance specific projects contributing to environmental or social objectives, the overall investment is considered to contribute to environmental and/or social objectives according to the Sustainable Investment methodology.

- Application of the following minimum exclusion criteria, as well as Sub-Fund specific minimum exclusion criteria, for direct investments:
- securities issued by companies having a severe violation / breach of principles and guidelines such as the Principles of the United Nations Global Compact, the OECD Guidelines for Multinational Enterprises, and the United Nations Guiding Principles for Business and Human Rights on the grounds of problematic practices around human rights, labour rights, environment, and corruption issues,
- securities issued by companies involved in controversial weapons (anti-personnel mines, cluster munitions, chemical weapons, biological weapons, depleted uranium, white phosphorus, and nuclear weapons),
- securities issued by companies that derive more than 10% of their revenues from weapons, military equipment, and services,
- securities issued by companies that derive more than 10% of their revenue from thermal coal extraction,
- securities issued by utility companies that generate more than 20% of their revenues from coal,
- securities issued by companies involved in the production of tobacco, and securities issued by companies involved in the distribution of tobacco with more than 5% of their revenues.

Direct investments in sovereign issuers with an insufficient freedom house index score are excluded.

Moreover, Sub-Fund specific exclusion criteria for direct investments apply:

- securities issued by companies involved in Arctic Oil Drilling and other unconventional O&G production,
- securities issued by companies involved in Gambling,
- securities issued by companies that derive more than 10% of their revenues from high-proof Alcohol,
- securities issued by companies that derive more than 15% from sales to the Tobacco industry.

The sustainable minimum exclusion criteria, as well as the Sub-Fund specific minimum exclusion criteria, are based on information from an external data provider and coded in pre- and post-trade compliance. The review is performed at least half yearly.

Good governance practices include sound management structures, employee relations, remuneration of staff and tax compliance.

● **What is the policy to assess good governance practices of the investee companies?**

Good governance principles are considered by screening out companies based on their involvement in controversies around international norms corresponding to the four good governance practices: sound management structures, employee relations, remuneration of staff and tax compliance. Companies having a severe violation in either of those areas will not be investible. For certain cases, flagged issuers shall be on a watch list. These companies will appear on this watch list when the Investment Manager believes that engagement may lead to improvements or when the company is assessed to take remedial actions. Companies on the watch list remain investible unless the Investment Manager believes that the engagement or the remedial actions of the company does not lead to the desired remedy of the severe controversy.

In addition, the Sub-Fund’s Investment Manager is committed to actively encourage open dialogues with investee companies on corporate governance, proxy voting and broader sustainability issues in advance of shareholder meetings (regularly for direct investments in shares). The Sub-Fund’s Investment Manager’s approach to proxy voting and company engagement is set out in the Management Company’s Stewardship Statement.



Asset allocation describes the share of investments in specific assets.

What is the asset allocation and the minimum share of sustainable investments?

The Sub-Fund invest primarily into securities which offer products and services to facilitate the achievements of the SDGs. The Sub-Fund will invest more than 80% of its assets in Sustainable Investments.

The minimum percentage of investments with an environmental objective is 40%. The minimum percentage of investments that are aligned with the EU Taxonomy is 0.01%. The minimum percentage of investments with a social objective is 5%.



● **How does the use of derivatives attain the sustainable investment objective?**

Not applicable



To what minimum extent are sustainable investments with an environmental

objective aligned with the EU Taxonomy?

The Taxonomy-aligned investments include debt and/or equity in environmentally sustainable economic activities aligned with the EU-Taxonomy. The minimum percentage of investments that are aligned with the EU Taxonomy is 0.01%. Taxonomy-aligned data is provided by an external data provider. The Investment Manager has assessed the quality of such data. The data will not be subject to an assurance provided by auditors or a review by third parties. The data will not reflect any data in government bonds. As of today, there is no recognized methodology available to determine the proportion of Taxonomy-aligned activities when investing in government bonds.

Taxonomy-aligned activities in this disclosure are based on share of turnover. Pre-contractual figures use turnover as its financial metric as a default in line with the regulatory requirements and based on the fact that complete, verifiable or up-to date data for CAPEX and/or OPEX as financial metric is even less available.

Taxonomy-aligned data is only in rare cases data reported by companies in accordance with the EU Taxonomy. The data provider has derived Taxonomy-aligned data from other available equivalent public data.

● **Does the financial product invest in fossil gas and/or nuclear energy related activities that comply with the EU Taxonomy ¹?**

- Yes:
- In fossil gas In nuclear energy
- No

The Sub-Fund does not pursue any investments in fossil gas and/or nuclear energy related activities that comply with the EU Taxonomy. Nevertheless, as result of this investment strategy, investments may occur in corporates which are also active in these activities. Further information will be provided as part of the annual reporting, if relevant.

The two graphs below show in green the minimum percentage of investments that are aligned with the EU Taxonomy. As there is no appropriate methodology to determine the Taxonomy-alignment of sovereign bonds, the first graph shows the Taxonomy-alignment in relation to all the investments of the financial product including sovereign bonds, while the second graph shows the Taxonomy-alignment only in relation to the investments of the financial product other than sovereign bonds.*

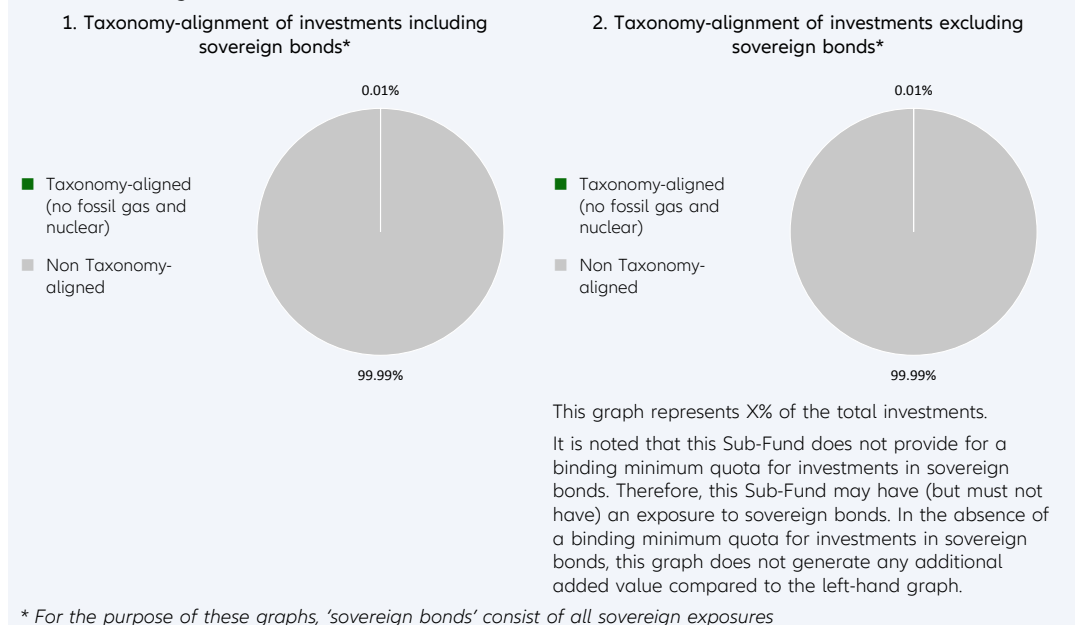

This graph represents X% of the total investments. It is noted that this Sub-Fund does not provide for a binding minimum quota for investments in sovereign bonds. Therefore, this Sub-Fund may have (but must not have) an exposure to sovereign bonds. In the absence of a binding minimum quota for investments in sovereign bonds, this graph does not generate any additional added value compared to the left-hand graph.

● **What is the minimum share of investments in transitional and enabling activities?**

The Sub-Fund's Investment Manager does not commit to a split of minimum taxonomy alignment into transitional, enabling activities and own performance.

Taxonomy-aligned activities are expressed as a share of:

- **turnover** reflecting the share of revenue from green activities of investee companies
- **capital expenditure** (CapEx) showing the green investments made by investee companies, e.g. for a transition to a green economy.
- **operational expenditure** (OpEx) reflecting green operational activities of investee companies.

Enabling activities directly enable other activities to make a substantial contribution

¹ Fossil gas and/or nuclear related activities will only comply with the EU Taxonomy where they contribute to limiting climate change ("climate change mitigation") and do not significantly harm any EU Taxonomy objective - see explanatory note in the left hand margin. The full criteria for fossil gas and nuclear energy economic activities that comply with the EU Taxonomy are laid down in Commission Delegated Regulation (EU) 2022/1214.

to an environmental objective.

Transitional activities are activities for which low-carbon alternatives are not yet available and among others have greenhouse gas emission levels corresponding to the best performance.



are environmentally sustainable investments that **do not take into account the criteria** for environmentally sustainable economic activities under the EU Taxonomy.



What is the minimum share of sustainable investments with an environmental objective that are not aligned with the EU Taxonomy?

Taxonomy-aligned investments are considered a sub-category of Sustainable Investments. If an investment is not Taxonomy-aligned since the activity is not yet covered under the EU Taxonomy or the positive contribution is not substantial enough to comply with the Taxonomy technical screening criteria, the investment can still be considered an environmentally Sustainable Investment provided it complies with all criteria. The total share of environmentally Sustainable Investments including EU Taxonomy of the Sub-Fund is at least 40%. The overall sustainable investment share may also include investments with an environmental objective in economic activities that do not qualify as environmentally sustainable under the EU Taxonomy. Combined with socially Sustainable Investment the Sub-Fund will invest more than 80% of its assets in Sustainable Investments.



What is the minimum share of sustainable investments with a social objective?

The Sub-Fund’s investment manager commits to a minimum share of socially Sustainable Investments of 5%. Combined with environmentally Sustainable Investment the Sub-Fund will invest more than 80% of its assets in Sustainable Investments



What investments are included under “#2 Not sustainable”, what is their purpose and are there any minimum environmental or social safeguards?

Under “#2 Not sustainable” parts of investments are included related to business activities which are not counted as Sustainable Investments. In addition, the Investment Manager might invest into cash, Targets Funds, or derivatives which might be used for efficient portfolio management (including risk hedging) and/or investment purposes, and Target Funds to benefit from a specific strategy. For those investments no environmental or social safeguards are applied.



Is a specific index designated as a reference benchmark to meet the sustainable investment objective?

No reference benchmark has been designated for the purpose of meeting the sustainable investment objective.

Reference benchmarks are indexes to measure whether the financial product attains the sustainable investment objective.

- **How does the reference benchmark take into account sustainability factors in a way that is continuously aligned with the sustainable investment objective?**
Not applicable
- **How is the alignment of the investment strategy with the methodology of the index ensured on a continuous basis?**
Not applicable

- How does the designated index differ from a relevant broad market index?
Not applicable
- Where can the methodology used for the calculation of the designated index be found?
Not applicable



Where can I find more product specific information online?

More product-specific information can be found on the website: <https://regulatory.allianzgi.com/SFDR>

Template pre-contractual disclosure for the financial products referred to in Article 8, paragraphs 1, 2 and 2a, of Regulation (EU) 2019/2088 and Article 6, first paragraph, of Regulation (EU) 2020/852

Product name:

Allianz SDG Global Equity

Legal entity identifier: 529900TZLZ3XIEIHC86

Environmental and/or social characteristics

Sustainable investment means an investment in an economic activity that contributes to an environmental or social objective, provided that the investment does not significantly harm any environmental or social objective and that the investee companies follow good governance practices.

The **EU Taxonomy** is a classification system laid down in Regulation (EU) 2020/852, establishing a list of **environmentally sustainable economic activities**. That Regulation does not include a list of socially sustainable economic activities. Sustainable investments with an environmental objective might be aligned with the Taxonomy or not.

Does this financial product have a sustainable investment objective?	
Yes	No
<input type="checkbox"/> It will make a minimum of sustainable investments with an environmental objective: ___% <ul style="list-style-type: none"> <input type="checkbox"/> in economic activities that qualify as environmentally sustainable under the EU Taxonomy <input type="checkbox"/> in economic activities that do not qualify as environmentally sustainable under the EU Taxonomy 	<input checked="" type="checkbox"/> It promotes Environmental/Social (E/S) characteristics and while it does not have as its objective a sustainable investment, it will have a minimum proportion of 50.00% of sustainable investments <ul style="list-style-type: none"> <input checked="" type="checkbox"/> with an environmental objective in economic activities that qualify as environmentally sustainable under the EU Taxonomy <input checked="" type="checkbox"/> with an environmental objective in economic activities that do not qualify as environmentally sustainable under the EU Taxonomy <input checked="" type="checkbox"/> with a social objective
<input type="checkbox"/> It will make a minimum of sustainable investments with a social objective ___%	<input type="checkbox"/> It promotes E/S characteristics, but will not make any sustainable investments



What environmental and/or social characteristics are promoted by this financial product?

Allianz SDG Global Equity's (the "Sub-Fund") invests in securities of companies providing products or services which contribute to environmental or social objectives, as defined by the UN Sustainable Development Goals (SDGs) or the EU Taxonomy objectives, which are also related to the SDGs. The contribution is measured according to the Sustainable Investment methodology.

In addition, sustainable minimum exclusion criteria and Sub-Fund specific exclusion criteria apply.

No reference benchmark has been designated for the purpose of attaining the environmental and/or social characteristics promoted by the Sub-Fund.

What sustainability indicators are used to measure the attainment of each of the environmental or social characteristics promoted by this financial product?

To measure the attainment of the Sub-Fund's sustainable investment objective the following sustainability indicators are used and reported on, at the fiscal year end:

- The actual Sustainable Investment share – which is based on SDGs or EU Taxonomy objectives
- Principle Adverse Impacts (PAIs) of investment decisions on sustainability factors are considered through the application of exclusion criteria.

Sustainability indicators measure how the environmental or social characteristics promoted by the financial product are attained.

- **What are the objectives of the sustainable investments that the financial product partially intends to make and how does the sustainable investment contribute to such objectives?**

Sustainable investments contribute to environmental and/or social objectives, for which the Investment Manager uses as reference frameworks, among others, the UN Sustainable Development Goals (SDGs), as well as the objectives of the EU Taxonomy:

1. Climate Change Mitigation
2. Climate Change Adaptation
3. Sustainable Use and Protection of Water and Marine Resources
4. Transition to a Circular Economy
5. Pollution Prevention and Control
6. Protection and Restoration of Biodiversity and Ecosystems

The assessment of the positive contribution to the environmental or social objectives is based on a proprietary framework which combines quantitative elements with qualitative inputs from internal research. The methodology applies first a quantitative breakdown of a securities issuer into its business activities. The qualitative element of the framework is an assessment if business activities contribute positively to an environmental or a social objective.

To calculate the positive contribution on the Fund level the revenue share of each issuer attributable to business activities contributing to environmental and/or social objectives is considered provided the issuer is satisfying the Do No Significant Harm (“DNSH”) and Good Governance principles, and an asset-weighted aggregation is performed as a second step. Moreover, for certain types of securities, which finance specific projects contributing to environmental or social objectives the overall investment is considered to contribute to environmental and/or social objectives, but also for these a DNSH as well as a Good Governance check for issuers is performed.

- **How do the sustainable investments that the financial product partially intends to make, not cause significant harm to any environmental or social sustainable investment objective?**

In order to ensure that Sustainable Investments do not significantly harm any other environmental and/or social objective, the Investment Manager is leveraging the PAI indicators, whereby significance thresholds have been defined to identify significantly harmful issuers. Issuers not meeting the significance threshold can be engaged for a limited time period to remediate the adverse impact. Otherwise, if the issuer does not meet the defined significance thresholds twice subsequently or in case of a failed engagement, it does not pass the DNSH assessment. Investments in securities of issuers which do not pass the DNSH assessment are not counted as sustainable investments.

- *How have the indicators for adverse impacts on sustainability factors been taken into account?*

All mandatory PAI indicators are considered either as part of the application of the exclusion criteria or through thresholds on a sectorial or absolute basis. Significance thresholds have been defined and they refer to qualitative or quantitative criteria.

Recognizing the lack of data coverage for some of the PAI indicators equivalent data points are used to assess PAI indicators when applying the DNSH assessment, when relevant, for the following indicators for corporates: share of non-renewable energy consumption and production, activities negatively affecting biodiversity-sensitive areas, emissions to water, lack of processes and compliance mechanisms to monitor compliance with UNGC principles and OECD Guidelines for Multinational Enterprises; for sovereigns: GHG Intensity and investee countries subject to social violations. In case of securities which finance specific projects contributing to environmental or social objectives equivalent data at project level might be used to ensure that Sustainable Investments do not significantly harm any other environmental and/or social objective. The Investment Manager will strive to increase data coverage for PAI indicators with low data coverage by engaging with issuers and data providers. The Investment Manager will regularly evaluate whether the availability of data has increased sufficiently to potentially include assessment of such data in the investment process.

- *How are the sustainable investments aligned with the OECD Guidelines for Multinational Enterprises and the UN Guiding Principles on Business and Human Rights? Details:*

The Investment Manager’s sustainable minimum exclusion list screens out companies based on their involvement in controversial practices against international norms. The core normative framework consists of the Principles of the UN Global Compact, the OECD Guidelines for Multinational Enterprises

Principal adverse impacts are the most significant negative impacts of investment decisions on sustainability factors relating to environmental, social and employee matters, respect for human rights, anti-corruption and anti-bribery matters.

and the UN Guiding Principles for Business and Human Rights. Securities issued by companies having a severe violation of these frameworks will be restricted from the investment universe.

The EU Taxonomy sets out a “do not significant harm” principle by which Taxonomy-aligned investments should not significantly harm EU Taxonomy objectives and is accompanied by specific EU criteria.

The “do not significant harm” principle applies only to those investments underlying the financial product that take into account the EU criteria for environmentally sustainable economic activities. The investments underlying the remaining portion of this financial product do not take into account the EU criteria for environmentally sustainable economic activities.

Any other sustainable investments must also not significantly harm any environmental or social objectives.



Does this financial product consider principal adverse impacts on sustainability factors?

Yes

No

The Management Company has joined the Net Zero Asset Manager Initiative and considers PAI indicators through stewardship including engagement, both are relevant to mitigate potential adverse impact as a company.

Due to the commitment to the Net Zero Asset Manager Initiative, the Management Company aims to reduce greenhouse gas emissions in partnership with asset owner clients on decarbonisation goals, consistent with an ambition to reach net zero emission by 2050 or sooner across all assets under management. As part of this objective the Management Company will set an interim target for the proportion of assets to be managed in line with the attainment of net zero emissions by 2050 or sooner.

The Sub-Fund’s Investment Manager considers PAI indicators regarding greenhouse gas emission, biodiversity, water, waste as well as social and employee matters for corporate issuers, and, where relevant, the freedom house index is applied to investments in sovereigns. PAI indicators are considered within the Investment Manager’s investment process through the means of exclusions as described in the “sustainable investment objective” section of the Sub-Fund.

The data coverage for the data required for the PAI indicators is heterogenous. The data coverage related to biodiversity, water and waste is low and the related PAI indicators are considered through exclusion of securities issued by companies having a severe violation / breach of principles and guidelines such as the Principles of the United Nations Global Compact, the OECD Guidelines for Multinational Enterprises, and the United Nations Guiding Principles for Business and Human Rights on the grounds of problematic practices around human rights, labour rights, environment, and corruption issues. Therefore, the Investment Manager will strive to increase data coverage for PAI indicators with low data coverage. The Investment Manager will regularly evaluate whether the availability of data has increased sufficiently to potentially include assessment of such data in the investment process.

Additionally, PAI indicators are considered as part of the requirement of the Sub-Fund to invest more than 50% into Sustainable Investments. PAI indicators are used as part of the DNSH assessment. Investments in securities of issuers who do not pass the DNSH assessment are not counted as sustainable investments.

The following PAI indicators are considered:

Applicable to corporate issuers

- GHG Emissions
- Carbon footprint
- GHG Intensity of investee companies
- Exposure to companies active in the fossil fuel sector
- Share of non-renewable energy consumption and production
- Energy consumption intensity per high impact climate sector
- Activities negatively affecting biodiversity-sensitive areas
- Emissions to water
- Hazardous waste ratio
- Violation of UN Global compact principles

- Lack of processes and compliance mechanisms to monitor compliance with UN Global Compact principles
- Unadjusted gender pay gap
- Board gender diversity
- Exposure to controversial weapons

Applicable to sovereign and supranational issuers

- GHG Intensity
- Investee countries subject to social violations

The information on the PAI indicators will be available in the end-year report of the Sub-Fund.



What investment strategy does this financial product follow?

The investment strategy guides investment decisions based on factors such as investment objectives and risk tolerance.

Allianz SDG Global Equity's investment objective is to invest in global Equity Markets in accordance with the SDG-Aligned Strategy with a focus on companies that contribute to one or more United Nations' SDGs, and hence create positive outcomes for environment and society.

The Sub-Fund invests in Equities of companies which engage in one or more SDGs and offer products and services across the themes of affordable healthcare, education, energy transition, food security, financial inclusion, water and waste management as targeted by the SDG No. 1, 2, 3, 4, 5, 6, 7, 8, 9, 10, 11, 12, 13, 14, 15, 16 and 17.

The Sub-Fund's general investment approach (Sub-Fund's applicable General Asset Class Principles in combination with its individual investment restrictions) is described in the prospectus.

● What are the binding elements of the investment strategy used to select the investments to attain each of the environmental or social characteristics promoted by this financial product?

The binding elements are:

- Minimum 50% of the Sub-Fund assets' weighted average shall result from revenue generated from issuers' activities that facilitate the achievement of one or more SDG or EU Taxonomy objectives as measured according to the Sustainable Investment methodology.
- For at least 80% of the Sub-Fund portfolio, the respective issuer shall have a minimum share of 20% Sustainable Investments. Cash and derivatives are excluded from the aforesaid thresholds.
- Application of the below sustainable minimum exclusion criteria and Sub-Fund specific exclusion criteria.

The following sustainable minimum exclusion criteria for direct investments apply:

- securities issued by companies having a severe violation / breach of principles and guidelines such as the Principles of the United Nations Global Compact, the OECD Guidelines for Multinational Enterprises, and the United Nations Guiding Principles for Business and Human Rights on the grounds of problematic practices around human rights, labour rights, environment, and corruption issues,
- securities issued by companies involved in controversial weapons (anti-personnel mines, cluster munitions, chemical weapons, biological weapons, depleted uranium, white phosphorus, and nuclear weapons),
- securities issued by companies that derive more than 10% of their revenues from weapons, military equipment, and services,
- securities issued by companies that derive more than 10% of their revenue from thermal coal extraction,
- securities issued by utility companies that generate more than 20% of their revenues from coal,
- securities issued by companies involved in the production of tobacco, and securities issued by companies involved in the distribution of tobacco with more than 5% of their revenues.

The following Sub-Fund specific exclusion criteria for direct investments apply:

- Sub-fund assets may not be invested in Equities of issuers which are involved in the production of hydraulic fracturing and/or which provide services in relation to hydraulic fracturing of more than 5% of their revenues

- Sub-fund assets may not be invested in Equities of issuers which are involved in the production of alcohol (limited to spirits) of more than 10% of their revenues
- Sub-fund assets may not be invested in Equities of issuers which are involved in the production of agricultural genetically modified organisms -GMOs- of more than 5% of their revenues
- Sub-fund assets may not be invested in Equities of issuers which are involved in the production of nuclear power and/or which provide services in relation to nuclear power of more than 10% of their revenues
- Sub-fund assets may not be invested in Equities of issuers which are involved in the production of arctic drilling
- Sub-Fund assets may not be invested in Equities of issuers which are involved in the production of gambling and/or which are involved in the distribution/sales of gambling and/or which provide services in relation to gambling of more than 5% of their revenues
- Sub-Fund assets may not be invested in Equities of issuers which are involved in the production and/or exploration of oil sands of more than 5% of their revenues
- Sub-Fund assets may not be invested in Equities of issuers which are involved in the production of military equipment and services and/or which are involved in the distribution/sales of military equipment and services and/or which provide services in relation to military equipment and services of more than 5% of their revenues
- Sub-Fund assets may not be invested in Equities of issuers which are involved in the production of pornography of more than 1% of their revenues and/or which are involved in the distribution/sales of pornography of more than 1% of their revenues

Direct investments in sovereign issuers with an insufficient freedom house index score are excluded.

The sustainable minimum exclusion criteria, as well as the Sub-Fund specific exclusion criteria are based on information from an external data provider and coded in pre- and post-trade compliance. The review is performed at least half yearly.

● **What is the committed minimum rate to reduce the scope of the investments considered prior to the application of that investment strategy?**

The Sub-Fund does not commit to reduce the scope of the investments by a certain minimum rate.

● **What is the policy to assess good governance practices of the investee companies?**

Good governance principles are considered by screening out companies based on their involvement in controversies around international norms corresponding to the four good governance practices: sound management structures, employee relations, remuneration of staff and tax compliance. Companies having a severe violation in either of those areas will not be investible. For certain cases, flagged issuers shall be on a watch list. These companies will appear on this watch list when the Investment Manager believes that engagement may lead to improvements or when the company is assessed to take remedial actions. Companies on the watch list remain investible unless the Investment Manager believes that the engagement or the remedial actions of the company does not lead to the desired remedy of the severe controversy.

In addition, the Sub-Fund's Investment Manager is committed to actively encourage open dialogues with investee companies on corporate governance, proxy voting and broader sustainability issues in advance of shareholder meetings (regularly for direct investments in shares). The Sub-Fund's Investment Manager's approach to proxy voting and company engagement is set out in the Management Company's Stewardship Statement.

Good governance practices include sound management structures, employee relations, remuneration of staff and tax compliance.



What is the asset allocation planned for this financial product?

Asset allocation describes the share of investments in specific assets.

Min. 80% of the Sub-Funds' assets (excluding cash, and derivatives) are used to meet the environmental or social characteristics promoted by this Sub-Fund. A low portion of the Sub-Fund might contain assets which do not promote environmental or social characteristics. Example of such instruments are derivatives, cash and deposits, some Target Funds and investment with temporarily divergent or absent environmental, social, or good governance qualifications. The Sub-Fund invest primarily into securities which offer products and services to facilitate the achievements of the SDGs. Min. 50% of the Sub-Funds' assets will be invested in Sustainable Investments. The minimum percentage of investments that are aligned with the EU Taxonomy is 0.01%. The Sub-

Fund's Investment Manager does not commit to a minimum share of environmentally Sustainable Investments that are not aligned with the EU Taxonomy. The Sub-Fund's Investment Manager does not commit to a minimum share of socially sustainable investments. While the Sub-Fund cannot commit to a minimum share of environmentally or socially sustainable investments, such investments may be freely allocated to within the Sub-Fund aggregated sustainable investment commitment disclosed (min. 50%).

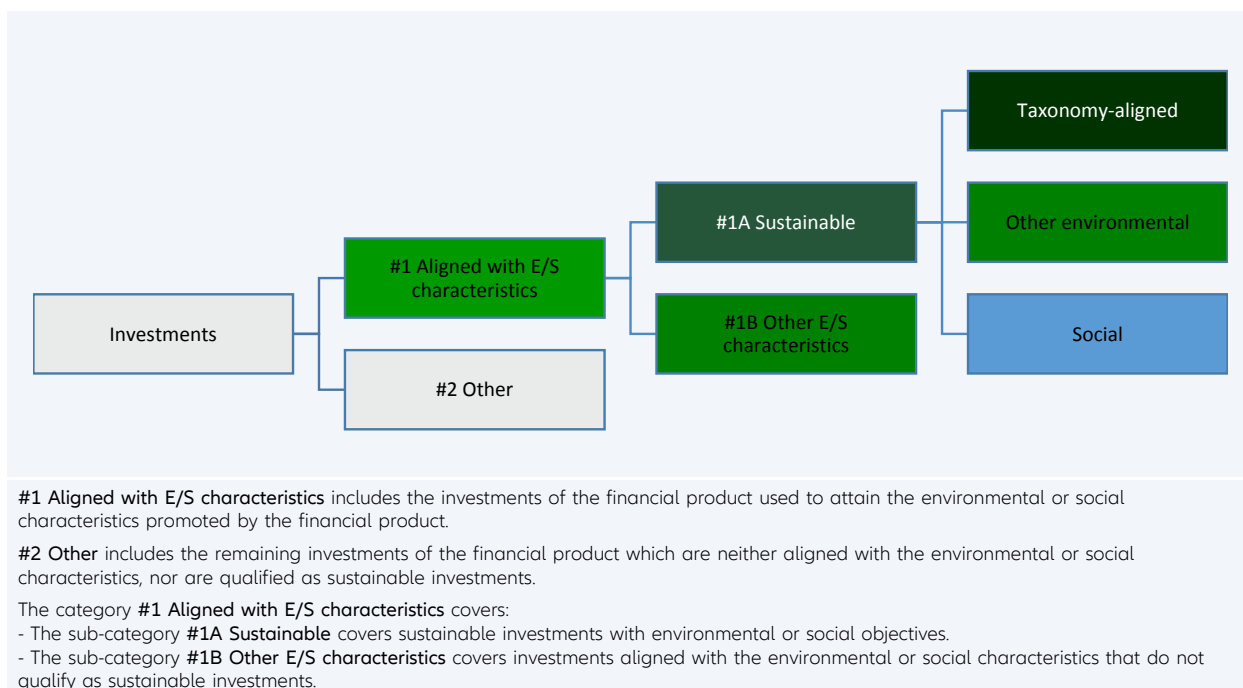

- **How does the use of derivatives attain the environmental or social characteristics promoted by the financial product?**

Not applicable



To what minimum extent are sustainable investments with an environmental objective aligned with the EU Taxonomy?

The Taxonomy-aligned investments include debt and/or equity in environmentally sustainable economic activities aligned with the EU-Taxonomy. The minimum percentage of investments that are aligned with the EU Taxonomy is 0.01%. Taxonomy-aligned data is provided by an external data provider. The Investment Manager has assessed the quality of such data. The data will not be subject to an assurance provided by auditors or a review by third parties. The data will not reflect any data in government bonds. As of today, there is no recognized methodology available to determine the proportion of Taxonomy-aligned activities when investing in government bonds.

Taxonomy-aligned activities in this disclosure are based on share of turnover. Pre-contractual figures use turnover as its financial metric as a default in line with the regulatory requirements and based on the fact that complete, verifiable or up-to date data for CAPEX and/or OPEX as financial metric is even less available.

Taxonomy-aligned data is only in rare cases data reported by companies in accordance with the EU Taxonomy. The data provider has derived Taxonomy-aligned data from other available equivalent public data.

- **Does the financial product invest in fossil gas and/or nuclear energy related activities that comply with the EU Taxonomy¹?**

Yes:

In fossil gas In nuclear energy

Taxonomy-aligned activities are expressed as a share of:
- **turnover** reflecting the share of revenue from green activities of

¹ Fossil gas and/or nuclear related activities will only comply with the EU Taxonomy where they contribute to limiting climate change ("climate change mitigation") and do not significantly harm any EU Taxonomy objective - see explanatory note in the left hand margin. The full criteria for fossil gas and nuclear energy economic activities that comply with the EU Taxonomy are laid down in Commission Delegated Regulation (EU) 2022/1214.

No

The Sub-Fund does not pursue any investments in fossil gas and/or nuclear energy related activities that comply with the EU Taxonomy. Nevertheless, as result of this investment strategy, investments may occur in corporates which are also active in these activities. Further information will be provided as part of the annual reporting, if relevant.

The two graphs below show in green the minimum percentage of investments that are aligned with the EU Taxonomy. As there is no appropriate methodology to determine the Taxonomy-alignment of sovereign bonds*, the first graph shows the Taxonomy-alignment in relation to all the investments of the financial product including sovereign bonds, while the second graph shows the Taxonomy-alignment only in relation to the investments of the financial product other than sovereign bonds.

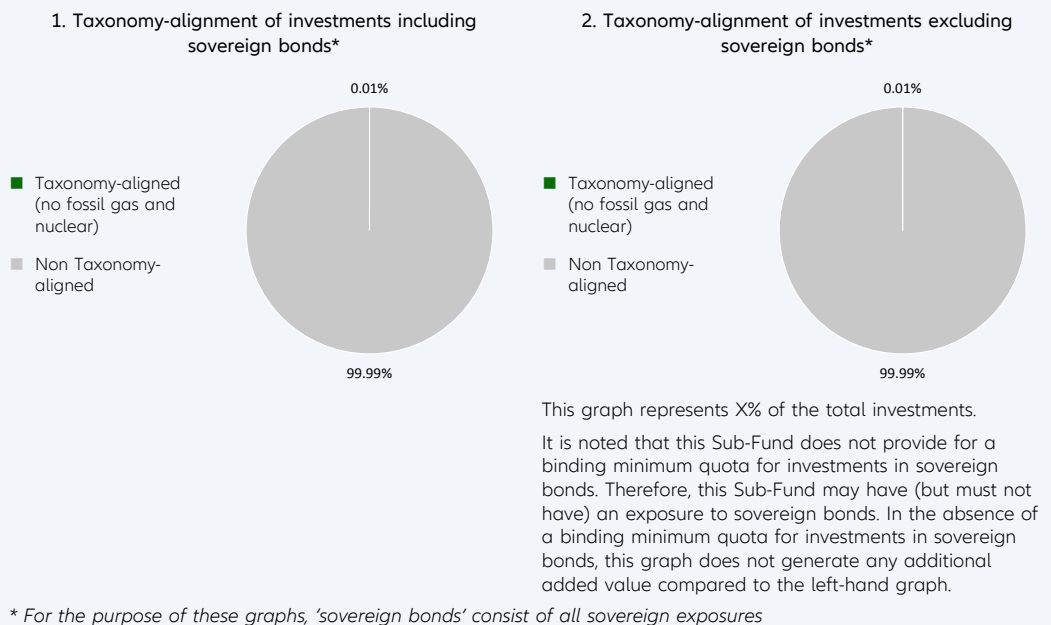

● **What is the minimum share of investments in transitional and enabling activities?**

The Sub-Fund's Investment Manager does not commit to a split of minimum taxonomy alignment into transitional, enabling activities and own performance.

● **What is the minimum share of sustainable investments with an environmental objective that are not aligned with the EU Taxonomy?**

Taxonomy-aligned investments are considered a sub-category of Sustainable Investments. If an investment is not Taxonomy-aligned since the activity is not yet covered under the EU Taxonomy or the positive contribution is not substantial enough to comply with the Taxonomy technical screening criteria, the investment can still be considered an environmentally Sustainable Investment provided it complies with all criteria. The Investment Manager does not commit to a minimum share of environmentally Sustainable Investments that are not aligned with the EU Taxonomy. The overall sustainable investment share may also include investments with an environmental objective in economic activities that do not qualify as environmentally sustainable under the EU Taxonomy, and while the Sub-Fund cannot commit to a minimum share of environmentally or socially sustainable

investee companies
- **capital expenditure** (CapEx) showing the green investments made by investee companies, e.g. for a transition to a green economy.
- **operational expenditure** (OpEx) reflecting green operational activities of investee companies.

Enabling activities directly enable other activities to make a substantial contribution to an environmental objective.

Transitional activities are activities for which low-carbon alternatives are not yet available and among others have greenhouse gas emission levels corresponding to the best performance.

are sustainable investments with an environmental objective that **do not take into account the criteria** for environmentally sustainable economic activities under the EU Taxonomy.

investments, such investments may be freely allocated to within the Sub-Fund aggregated sustainable investment commitment disclosed (min. 50%).



What is the minimum share of socially sustainable investments?

The Investment Manager defines Sustainable Investments based on internal research, which uses, among others, the UN Sustainable Development Goals (SDGs), as well as the objectives of the EU Taxonomy as reference frameworks. The Investment Manager does not commit to a minimum share of socially Sustainable Investments, as the SDGs contain environmental as well as social objectives. The overall sustainable investment share may also include investments with a social objective, and while the Sub-Fund cannot commit to a minimum share of environmentally or socially sustainable investments, such investments may be freely allocated to within the Sub-Fund aggregated sustainable investment commitment disclosed (min. 50%).



What investments are included under “#2 Other”, what is their purpose and are there any minimum environmental or social safeguards?

Under “#2 Other” investments into cash, Target Funds, or derivatives can be included. Derivatives might be used for efficient portfolio management (including risk hedging) and/or investment purposes, and Target Funds to benefit from a specific strategy. For those investments no environmental or social safeguards are applied.



Is a specific index designated as a reference benchmark to determine whether this financial product is aligned with the environmental and/or social characteristics that it promotes?

No reference benchmark has been designated for the purpose of attaining the environmental and/or social characteristics promoted by the Sub-Fund.

Reference benchmarks are indexes to measure whether the financial product attains the environmental or social characteristics that they promote.

- **How is the reference benchmark continuously aligned with each of the environmental or social characteristics promoted by the financial product?**
Not applicable
- **How is the alignment of the investment strategy with the methodology of the index ensured on a continuous basis?**
Not applicable
- **How does the designated index differ from a relevant broad market index?**
Not applicable
- **Where can the methodology used for the calculation of the designated index be found?**
Not applicable



Where can I find more product specific information online?

More product-specific information can be found on the website: <https://regulatory.allianzgi.com/SFDR>

Template pre-contractual disclosure for the financial products referred to in Article 8, paragraphs 1, 2 and 2a, of Regulation (EU) 2019/2088 and Article 6, first paragraph, of Regulation (EU) 2020/852

Product name:

Allianz Selective Global High Income

Legal entity identifier: 549300GJL672LFNCCQ34

Environmental and/or social characteristics

Sustainable investment means an investment in an economic activity that contributes to an environmental or social objective, provided that the investment does not significantly harm any environmental or social objective and that the investee companies follow good governance practices.

The EU Taxonomy is a classification system laid down in Regulation (EU) 2020/852, establishing a list of environmentally sustainable economic activities. That Regulation does not include a list of socially sustainable economic activities. Sustainable investments with an environmental objective might be aligned with the Taxonomy or not.

Does this financial product have a sustainable investment objective?	
Yes	No
<input type="checkbox"/> It will make a minimum of sustainable investments with an environmental objective: ___% <input type="checkbox"/> in economic activities that qualify as environmentally sustainable under the EU Taxonomy <input type="checkbox"/> in economic activities that do not qualify as environmentally sustainable under the EU Taxonomy	<input checked="" type="checkbox"/> It promotes Environmental/Social (E/S) characteristics and while it does not have as its objective a sustainable investment, it will have a minimum proportion of 5.00% of sustainable investments <input checked="" type="checkbox"/> with an environmental objective in economic activities that qualify as environmentally sustainable under the EU Taxonomy <input checked="" type="checkbox"/> with an environmental objective in economic activities that do not qualify as environmentally sustainable under the EU Taxonomy <input checked="" type="checkbox"/> with a social objective
<input type="checkbox"/> It will make a minimum of sustainable investments with a social objective ___%	<input type="checkbox"/> It promotes E/S characteristics, but will not make any sustainable investments



What environmental and/or social characteristics are promoted by this financial product?

Allianz Selective Global High Income (the "Sub-Fund") is managed according to the Sustainability Key Performance Indicator Strategy (Relative) ("KPI Strategy (Relative)") which addresses greenhouse gas (GHG) Intensity. The "Sustainability KPI" measures the GHG Intensity defined by the weighted average intensity of greenhouse gas emissions based on company's annual sales ("GHG Intensity").

GHG Intensity will be addressed by outperforming the Weighted Average GHG Intensity against its benchmark.

In addition, sustainable minimum exclusion criteria apply.

A reference benchmark has been designated for the purpose of attaining the environmental and/or social characteristics promoted by the Sub-Fund.

What sustainability indicators are used to measure the attainment of each of the environmental or social characteristics promoted by this financial product?

To measure the attainment of the environmental and/or social characteristics the following sustainability indicators are used and reported on, at the fiscal year end:

- The actual percentage of KPI coverage of the Sub-Fund's Portfolio (Portfolio in this respect does not comprise derivatives and instruments that are non-evaluated by nature (e. g., cash and deposits)).
- The actual weighted average GHG Intensity portfolio vs weighted average GHG Intensity of the benchmark.
- Adherence to a 20% reduction of the investment universe.

Sustainability indicators measure how the environmental or social characteristics promoted by the financial product are attained.

- Confirmation that Principal adverse impacts (PAIs) of investment decisions on sustainability factors are considered through the application of exclusion criteria.

- **What are the objectives of the sustainable investments that the financial product partially intends to make and how does the sustainable investment contribute to such objectives?**

Sustainable investments contribute to environmental and/or social objectives, for which the Investment Manager uses as reference frameworks, among others, the UN Sustainable Development Goals (SDGs), as well as the objectives of the EU Taxonomy:

1. Climate Change Mitigation
2. Climate Change Adaptation
3. Sustainable Use and Protection of Water and Marine Resources
4. Transition to a Circular Economy
5. Pollution Prevention and Control
6. Protection and Restoration of Biodiversity and Ecosystems

The assessment of the positive contribution to the environmental or social objectives is based on a proprietary framework which combines quantitative elements with qualitative inputs from internal research. The methodology applies first a quantitative breakdown of a securities issuer into its business activities. The qualitative element of the framework is an assessment if business activities contribute positively to an environmental or a social objective.

To calculate the positive contribution on the Sub-Fund level the revenue share of each issuer attributable to business activities contributing to environmental and/or social objectives is considered provided the issuer is satisfying the Do No Significant Harm ("DNSH") and Good Governance principles, and an asset-weighted aggregation is performed as a second step. Moreover, for certain types of securities, which finance specific projects contributing to environmental or social objectives the overall investment is considered to contribute to environmental and/or social objectives, but also for these a DNSH as well as a Good Governance check for issuers is performed.

- **How do the sustainable investments that the financial product partially intends to make, not cause significant harm to any environmental or social sustainable investment objective?**

In order to ensure that Sustainable Investments do not significantly harm any other environmental and/or social objective, the Investment Manager is leveraging the PAI indicators, whereby significance thresholds have been defined to identify significantly harmful issuers. Issuers not meeting the significance threshold can be engaged for a limited time period to remediate the adverse impact. Otherwise, if the issuer does not meet the defined significance thresholds twice subsequently or in case of a failed engagement, it does not pass the DNSH assessment. Investments in securities of issuers which do not pass the DNSH assessment are not counted as sustainable investments.

- *How have the indicators for adverse impacts on sustainability factors been taken into account?*

All mandatory PAI indicators are considered either as part of the application of the exclusion criteria or through thresholds on a sectorial or absolute basis. Significance thresholds have been defined and they refer to qualitative or quantitative criteria.

Recognizing the lack of data coverage for some of the PAI indicators equivalent data points are used to assess PAI indicators when applying the DNSH assessment, when relevant, for the following indicators for corporates: share of non-renewable energy consumption and production, activities negatively affecting biodiversity-sensitive areas, emissions to water, lack of processes and compliance mechanisms to monitor compliance with UNGC principles and OECD Guidelines for Multinational Enterprises; for sovereigns: GHG Intensity and investee countries subject to social violations. In case of securities which finance specific projects contributing to environmental or social objectives equivalent data at project level might be used to ensure that Sustainable Investments do not significantly harm any other environmental and/or social objective. The Investment Manager will strive to increase data coverage for PAI indicators with low data coverage by engaging with issuers and data providers. The Investment Manager will regularly evaluate whether the availability of data has increased sufficiently to potentially include assessment of such data in the investment process.

Principal adverse impacts are the most significant negative impacts of investment decisions on sustainability factors relating to environmental, social and employee matters, respect for human rights, anti-corruption and anti-bribery matters.

- *How are the sustainable investments aligned with the OECD Guidelines for Multinational Enterprises and the UN Guiding Principles on Business and Human Rights? Details:*

The Investment Manager's sustainable minimum exclusion list screens out companies based on their involvement in controversial practices against international norms. The core normative framework consists of the Principles of the UN Global Compact, the OECD Guidelines for Multinational Enterprises and the UN Guiding Principles for Business and Human Rights. Securities issued by companies having a severe violation of these frameworks will be restricted from the investment universe.

The EU Taxonomy sets out a "do not significant harm" principle by which Taxonomy-aligned investments should not significantly harm EU Taxonomy objectives and is accompanied by specific EU criteria.

The "do not significant harm" principle applies only to those investments underlying the financial product that take into account the EU criteria for environmentally sustainable economic activities. The investments underlying the remaining portion of this financial product do not take into account the EU criteria for environmentally sustainable economic activities.

Any other sustainable investments must also not significantly harm any environmental or social objectives.



Does this financial product consider principal adverse impacts on sustainability factors?

Yes

No

The Management Company has joined the Net Zero Asset Manager Initiative and considers PAI indicators through stewardship including engagement, both are relevant to mitigate potential adverse impact as a company.

Due to the commitment to the Net Zero Asset Manager Initiative, the Management Company aims to reduce greenhouse gas emissions in partnership with asset owner clients on decarbonisation goals, consistent with an ambition to reach net zero emission by 2050 or sooner across all assets under management. As part of this objective the Management Company will set an interim target for the proportion of assets to be managed in line with the attainment of net zero emissions by 2050 or sooner.

The Sub-Fund's Investment Manager addresses PAI indicators regarding greenhouse gas emission, biodiversity, water, waste as well as social and employee matters for corporate issuers, and, where relevant, the freedom house index is applied to investments in sovereigns. PAI indicators are considered within the Investment Manager's investment process through the means of exclusions as described in the "binding elements" section of the Sub-Fund.

The data coverage for the data required for the PAI indicators is heterogenous. The data coverage related to biodiversity, water and waste is low and the related PAI indicators are considered through exclusion of securities issued by companies having a severe violation / breach of principles and guidelines such as the Principles of the United Nations Global Compact, the OECD Guidelines for Multinational Enterprises, and the United Nations Guiding Principles for Business and Human Rights on the grounds of problematic practices around human rights, labour rights, environment, and corruption issues. Therefore, the Investment Manager will strive to increase data coverage for PAI indicators with low data coverage. The Investment Manager will regularly evaluate whether the availability of data has increased sufficiently to potentially include assessment of such data in the investment process.

Additionally, the Investment manager considers GHG related PAI indicators by outperforming the Weighted Average GHG Intensity against its benchmark. The following PAI indicators are considered:

Applicable to corporate issuers

- GHG Emissions
- Carbon footprint
- GHG Intensity of investee companies
- Exposure to companies active in the fossil fuel sector
- Activities negatively affecting biodiversity-sensitive areas
- Emissions to water
- Hazardous waste ratio
- Violation of UN Global compact principles

- Lack of processes and compliance mechanisms to monitor compliance with UN Global Compact principles
- Board gender diversity
- Exposure to controversial weapons

Applicable to sovereign and supranational issuers

- Investee countries subject to social violations

The information on the PAI indicators will be available in the end-year report of the Sub-Fund.



What investment strategy does this financial product follow?

The investment strategy guides investment decisions based on factors such as investment objectives and risk tolerance.

Allianz Selective Global High Income's investment objective is to invest in global bond markets. The Sub-Fund tries to offer close to high yield returns with an expected volatility between investment grade and high yield in accordance with the Sustainability Key Performance Indicator Strategy (Relative) ("KPI Strategy (Relative)"). The Sub-Fund's strategy is to outperform the Weighted Average GHG Intensity against its benchmark. The outperformance is determined as the excess between the Sub-Fund's weighted average GHG Intensity and the Sub-Fund's benchmark Weighted Average GHG Intensity.

The weighted average GHG Intensity is the weighted average of the Sub-Fund's GHG Intensity (in tCO₂e per Millions of sales). Sales represent company's annual sales. This ratio of GHG normalized by Sales facilitates comparison between companies of different sizes. The ratio is in tCO₂e per Millions of sales. The metric allows comparing weighted average GHG Intensities of different portfolios to identify portfolios comprised of more GHG-efficient issuers in terms of the issuer's sales. The portfolio weights (and benchmark or universe weights) are rebased such that only issuers with GHG emissions data available are considered in the calculation. GHG represents a respective issuer's greenhouse gas emissions. To determine the GHG Intensity of a company issuer, GHG Intensity data from third party data providers will be used. The GHG intensity is analysed by the Investment Manager and is considered within the securities selection process in order to meet the Sub-Fund Investment objective.

The proportion of assets which do not have a GHG intensity assessment is expected to be low. Examples of instruments not having a GHG intensity assessment are cash and deposits, some Target Funds, and investments for which the GHG intensity is deemed to be not appropriate and/or data is not available.

The Sub-Fund's general investment approach (Sub-Fund's applicable General Asset Class Principles in combination with its individual investment restrictions) is described in the prospectus.

● What are the binding elements of the investment strategy used to select the investments to attain each of the environmental or social characteristics promoted by this financial product?

The binding elements are:

- Min. 90% KPI coverage of the Sub-Fund's Portfolio (Portfolio in this respect does not comprise derivatives and instruments that are non-evaluated by nature (e. g., cash and deposits)).
- Min. 30% outperformance of benchmark in terms of Weighted Average GHG Intensity.
- Reduction of investment universe by excluding at least the 20% the highest GHG Intensity issuers.
- Outperformance of the Benchmark excluding the 20% highest GHG Intensity issuers in terms of Weighted Average GHG Intensity.
- Application of the following sustainable minimum exclusion criteria for direct investments:
 - securities issued by companies having a severe violation / breach of principles and guidelines such as the Principles of the United Nations Global Compact, the OECD Guidelines for Multinational Enterprises, and the United Nations Guiding Principles for Business and Human Rights on the grounds of problematic practices around human rights, labour rights, environment, and corruption issues,
 - securities issued by companies involved in controversial weapons (anti-personnel mines, cluster munitions, chemical weapons, biological weapons, depleted uranium, white phosphorus, and nuclear weapons),
 - securities issued by companies that derive more than 10% of their revenues from weapons, military equipment, and services,
 - securities issued by companies that derive more than 10% of their revenue from thermal coal extraction,

- securities issued by utility companies that generate more than 20% of their revenues from coal,
- securities issued by companies involved in the production of tobacco, and securities issued by companies involved in the distribution of tobacco with more than 5% of their revenues.

Direct investments in sovereign issuers with an insufficient freedom house index score are excluded.

The sustainable minimum exclusion criteria are based on information from an external data provider and coded in pre- and post-trade compliance. The review is performed at least half yearly.

● **What is the committed minimum rate to reduce the scope of the investments considered prior to the application of that investment strategy?**

The Sub-Fund commits to reduce the investment universe by at least 20%.

● **What is the policy to assess good governance practices of the investee companies?**

Good governance principles are considered by screening out companies based on their involvement in controversies around international norms corresponding to the four good governance practices: sound management structures, employee relations, remuneration of staff and tax compliance. Companies having a severe violation in either of those areas will not be investible. For certain cases, flagged issuers shall be on a watch list. These companies will appear on this watch list when the Investment Manager believes that engagement may lead to improvements or when the company is assessed to take remedial actions. Companies on the watch list remain investible unless the Investment Manager believes that the engagement or the remedial actions of the company does not lead to the desired remedy of the severe controversy.

In addition, the Sub-Fund's Investment Manager is committed to actively encourage open dialogues with investee companies on corporate governance, proxy voting and broader sustainability issues in advance of shareholder meetings (regularly for direct investments in shares). The Sub-Fund's Investment Manager's approach to proxy voting and company engagement is set out in the Management Company's Stewardship Statement.

Good governance practices include sound management structures, employee relations, remuneration of staff and tax compliance.



What is the asset allocation planned for this financial product?

Asset allocation describes the share of investments in specific assets.

Min. 90% of the Sub-Funds' assets (excluding cash, and derivatives) are used to meet the environmental or social characteristics promoted by this Sub-Fund. A low portion of the Sub-Fund might contain assets which do not promote environmental or social characteristics. Examples of such instruments are derivatives, cash and deposits, some Target Funds and investment with temporarily divergent or absent environmental, social, or good governance qualifications. Min. 5% of the Sub-Funds' assets will be invested in Sustainable Investments. The minimum percentage of investments that are aligned with the EU Taxonomy is 0.01%. The Sub-Fund's Investment Manager does not commit to a minimum share of environmentally Sustainable Investments that are not aligned with the EU Taxonomy. The Sub-Fund's Investment Manager does not commit to a minimum share of socially sustainable investments. While the Sub-Fund cannot commit to a minimum share of environmentally or socially sustainable investments, such investments may be freely allocated to within the Sub-Fund aggregated sustainable investment commitment disclosed (min. 5%).

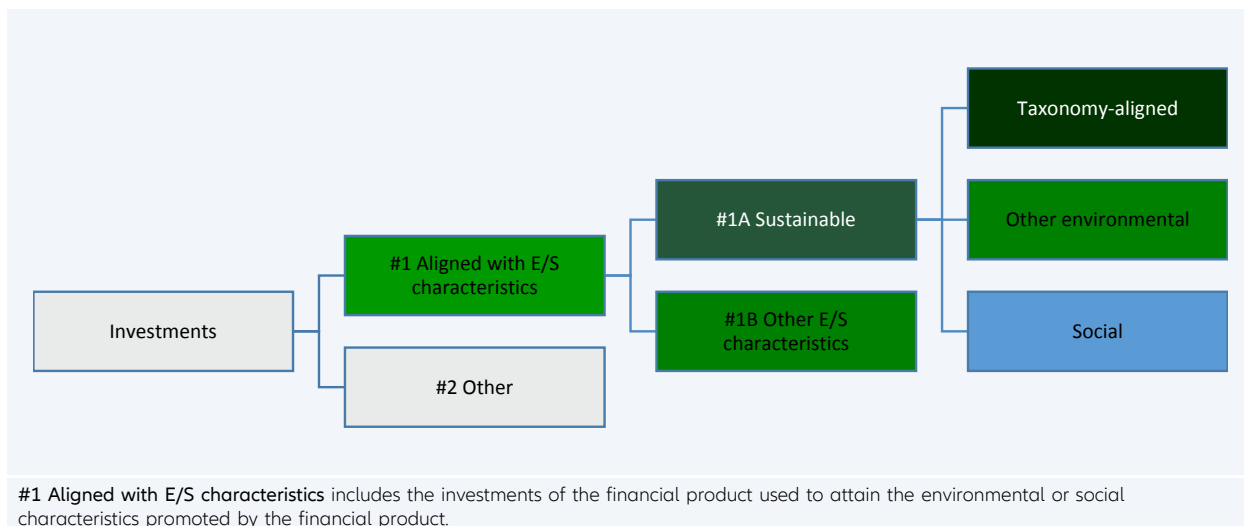

#2 Other includes the remaining investments of the financial product which are neither aligned with the environmental or social characteristics, nor are qualified as sustainable investments.

The category **#1 Aligned with E/S characteristics** covers:

- The sub-category **#1A Sustainable** covers sustainable investments with environmental or social objectives.
- The sub-category **#1B Other E/S characteristics** covers investments aligned with the environmental or social characteristics that do not qualify as sustainable investments.

- **How does the use of derivatives attain the environmental or social characteristics promoted by the financial product?**

Not applicable



To what minimum extent are sustainable investments with an environmental objective aligned with the EU Taxonomy?

The Taxonomy-aligned investments include debt and/or equity in environmentally sustainable economic activities aligned with the EU-Taxonomy. The minimum percentage of investments that are aligned with the EU Taxonomy is 0.01%. Taxonomy-aligned data is provided by an external data provider. The Investment Manager has assessed the quality of such data. The data will not be subject to an assurance provided by auditors or a review by third parties. The data will not reflect any data in government bonds. As of today, there is no recognized methodology available to determine the proportion of Taxonomy-aligned activities when investing in government bonds.

Taxonomy-aligned activities in this disclosure are based on share of turnover. Pre-contractual figures use turnover as its financial metric as a default in line with the regulatory requirements and based on the fact that complete, verifiable or up-to date data for CAPEX and/or OPEX as financial metric is even less available.

Taxonomy-aligned data is only in rare cases data reported by companies in accordance with the EU Taxonomy. The data provider has derived Taxonomy-aligned data from other available equivalent public data.

- **Does the financial product invest in fossil gas and/or nuclear energy related activities that comply with the EU Taxonomy¹?**

Yes:

In fossil gas In nuclear energy

No

The Sub-Fund does not pursue any investments in fossil gas and/or nuclear energy related activities that comply with the EU Taxonomy. Nevertheless, as result of this investment strategy, investments may occur in corporates which are also active in these activities. Further information will be provided as part of the annual reporting, if relevant.

Taxonomy-aligned activities are expressed as a share of:

- **turnover** reflecting the share of revenue from green activities of investee companies
- **capital expenditure** (CapEx) showing the green investments made by investee companies, e.g. for a transition to a green economy.
- **operational expenditure** (OpEx) reflecting green operational activities of investee companies.

¹ Fossil gas and/or nuclear related activities will only comply with the EU Taxonomy where they contribute to limiting climate change ("climate change mitigation") and do not significantly harm any EU Taxonomy objective - see explanatory note in the left hand margin. The full criteria for fossil gas and nuclear energy economic activities that comply with the EU Taxonomy are laid down in Commission Delegated Regulation (EU) 2022/1214.

The two graphs below show in green the minimum percentage of investments that are aligned with the EU Taxonomy. As there is no appropriate methodology to determine the Taxonomy-alignment of sovereign bonds*, the first graph shows the Taxonomy-alignment in relation to all the investments of the financial product including sovereign bonds, while the second graph shows the Taxonomy-alignment only in relation to the investments of the financial product other than sovereign bonds.

1. Taxonomy-alignment of investments including sovereign bonds*

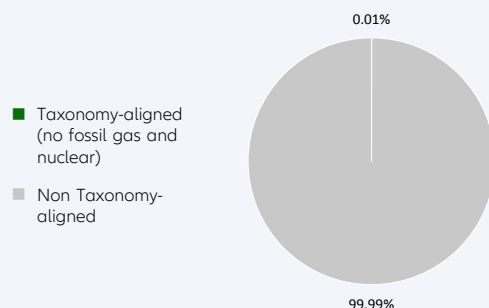

2. Taxonomy-alignment of investments excluding sovereign bonds*

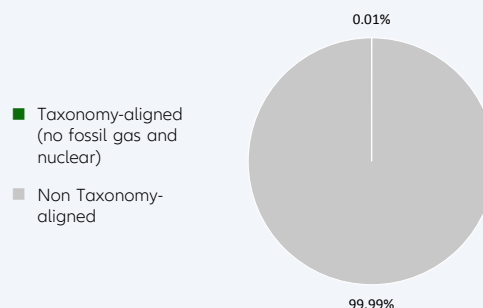

This graph represents X% of the total investments. It is noted that this Sub-Fund does not provide for a binding minimum quota for investments in sovereign bonds. Therefore, this Sub-Fund may have (but must not have) an exposure to sovereign bonds. In the absence of a binding minimum quota for investments in sovereign bonds, this graph does not generate any additional added value compared to the left-hand graph.

* For the purpose of these graphs, 'sovereign bonds' consist of all sovereign exposures

Enabling activities directly enable other activities to make a substantial contribution to an environmental objective.

Transitional activities are activities for which low-carbon alternatives are not yet available and among others have greenhouse gas emission levels corresponding to the best performance.

● **What is the minimum share of investments in transitional and enabling activities?**

The Sub-Fund's Investment Manager does not commit to a split of minimum taxonomy alignment into transitional, enabling activities and own performance.



What is the minimum share of sustainable investments with an environmental objective that are not aligned with the EU Taxonomy?

Taxonomy-aligned investments are considered a sub-category of Sustainable Investments. If an investment is not Taxonomy-aligned since the activity is not yet covered under the EU Taxonomy or the positive contribution is not substantial enough to comply with the Taxonomy technical screening criteria, the investment can still be considered an environmentally Sustainable Investment provided it complies with all criteria. The Investment Manager does not commit to a minimum share of environmentally Sustainable Investments that are not aligned with the EU Taxonomy. The overall sustainable investment share may also include investments with an environmental objective in economic activities that do not qualify as environmentally sustainable under the EU Taxonomy, and while the Sub-Fund cannot commit to a minimum share of environmentally or socially sustainable investments, such investments may be freely allocated to within the Sub-Fund aggregated sustainable investment commitment disclosed (min. 5%).



are sustainable investments with an environmental objective that **do not take into account the criteria** for environmentally sustainable economic activities under the EU Taxonomy.



What is the minimum share of socially sustainable investments?

The Investment Manager defines Sustainable Investments based on internal research, which uses, among others, the UN Sustainable Development Goals (SDGs), as well as the objectives of the EU Taxonomy as reference frameworks. The Investment Manager does not commit to a minimum share of socially Sustainable Investments, as the SDGs contain environmental as well as social objectives. The overall sustainable investment share may also include investments with a social objective, and while the Sub-Fund cannot commit to a minimum share of environmentally or socially sustainable investments, such investments may be freely allocated to within the Sub-Fund aggregated sustainable investment commitment disclosed (min. 5%).



What investments are included under “#2 Other”, what is their purpose and are there any minimum environmental or social safeguards?

Under “#2 Other” investments into cash, Target Funds, or derivatives can be included. Derivatives might be used for efficient portfolio management (including risk hedging) and/or investment purposes, and Target Funds to benefit from a specific strategy. For those investments no environmental or social safeguards are applied.



Is a specific index designated as a reference benchmark to determine whether this financial product is aligned with the environmental and/or social characteristics that it promotes?

Yes, the Sub-Fund has assigned the ICE BOFAML BB-B Global High Yield Index (hedged) as a benchmark. This benchmark is a market index. The Sub-Fund will promote environmental and social characteristics by outperforming the benchmark's Weighted Average GHG Intensity

Reference benchmarks are indexes to measure whether the financial product attains the environmental or social characteristics that they promote.

- **How is the reference benchmark continuously aligned with each of the environmental or social characteristics promoted by the financial product?**

The benchmark is a market index and does not incorporate environmental or social characteristics for index construction.

- **How is the alignment of the investment strategy with the methodology of the index ensured on a continuous basis?**

The benchmark is not continuously aligned as it does not incorporate environmental or social characteristics for index construction.

- **How does the designated index differ from a relevant broad market index?**

The benchmark is a broad market index.

- **Where can the methodology used for the calculation of the designated index be found?**

Details of the Benchmark's methodology may be found at <https://www.theice.com/market-data/indices/fixed-income-indices>



Where can I find more product specific information online?

More product-specific information can be found on the website: <https://regulatory.allianzgi.com/SFDR>

Template pre-contractual disclosure for the financial products referred to in Article 8, paragraphs 1, 2 and 2a, of Regulation (EU) 2019/2088 and Article 6, first paragraph, of Regulation (EU) 2020/852

Product name:

Allianz Short Duration Global Bond SRI

Legal entity identifier: 549300OYIOIK6HSXWK48

Environmental and/or social characteristics

Sustainable investment means an investment in an economic activity that contributes to an environmental or social objective, provided that the investment does not significantly harm any environmental or social objective and that the investee companies follow good governance practices.

The **EU Taxonomy** is a classification system laid down in Regulation (EU) 2020/852, establishing a list of **environmentally sustainable economic activities**. That Regulation does not include a list of socially sustainable economic activities. Sustainable investments with an environmental objective might be aligned with the Taxonomy or not.

Does this financial product have a sustainable investment objective?	
<input checked="" type="radio"/> <input checked="" type="radio"/> Yes	<input checked="" type="radio"/> <input type="radio"/> No
<input type="checkbox"/> It will make a minimum of sustainable investments with an environmental objective : ____% <input type="checkbox"/> in economic activities that qualify as environmentally sustainable under the EU Taxonomy <input type="checkbox"/> in economic activities that do not qualify as environmentally sustainable under the EU Taxonomy	<input checked="" type="checkbox"/> It promotes Environmental/Social (E/S) characteristics and while it does not have as its objective a sustainable investment, it will have a minimum proportion of 10.00% of sustainable investments <input checked="" type="checkbox"/> with an environmental objective in economic activities that qualify as environmentally sustainable under the EU Taxonomy <input checked="" type="checkbox"/> with an environmental objective in economic activities that do not qualify as environmentally sustainable under the EU Taxonomy <input checked="" type="checkbox"/> with a social objective
<input type="checkbox"/> It will make a minimum of sustainable investments with a social objective ____%	<input type="checkbox"/> It promotes E/S characteristics, but will not make any sustainable investments



What environmental and/or social characteristics are promoted by this financial product?

Allianz Short Duration Global Bond SRI (the "Sub-Fund") promotes environmental, social, human rights, governance, and business behaviour factors (this domain does not apply for sovereigns issued by a Sovereign Entity) through integration of a best-in-class approach into the Sub-Fund's investment process. This encompasses the evaluation of corporate or sovereign issuers based on an SRI Rating which is used to construct the portfolio.

In addition, sustainable minimum exclusion criteria apply and Sub-Fund specific exclusion criteria apply.

No reference benchmark has been designated for the purpose of attaining the environmental and/or social characteristics promoted by the Sub-Fund.

● What sustainability indicators are used to measure the attainment of each of the environmental or social characteristics promoted by this financial product?

To measure the attainment of the environmental and/or social characteristics the following sustainability indicators are used and reported on, at the fiscal year end:

- The actual percentage of the Sub-Fund's Portfolio (Portfolio in this respect does not comprise non-rated derivatives and instruments that are non-rated by nature (e. g., cash and deposits)) assets invested in best-in-class issuers (issuers with a minimum SRI Rating of 2 out of a scale from 0-4; 0 being the worst rating and 4 the best rating).
- Confirmation that Principal Adverse Impacts (PAIs) of investment decisions on sustainability factors are considered through the application of exclusion criteria.

Sustainability indicators measure how the environmental or social characteristics promoted by the financial product are attained.

● **What are the objectives of the sustainable investments that the financial product partially intends to make and how does the sustainable investment contribute to such objectives?**

Sustainable investments contribute to environmental and/or social objectives, for which the Investment Manager uses as reference frameworks, among others, the UN Sustainable Development Goals (SDGs), as well as the objectives of the EU Taxonomy:

1. Climate Change Mitigation
2. Climate Change Adaptation
3. Sustainable Use and Protection of Water and Marine Resources
4. Transition to a Circular Economy
5. Pollution Prevention and Control
6. Protection and Restoration of Biodiversity and Ecosystems

The assessment of the positive contribution to the environmental or social objectives is based on a proprietary framework which combines quantitative elements with qualitative inputs from internal research. The methodology applies first a quantitative breakdown of a securities issuer into its business activities. The qualitative element of the framework is an assessment if business activities contribute positively to an environmental or a social objective.

To calculate the positive contribution on the Sub-Fund level the revenue share of each issuer attributable to business activities contributing to environmental and/or social objectives is considered provided the issuer is satisfying the Do No Significant Harm (“DNSH”) and Good Governance principles, and an asset-weighted aggregation is performed as a second step. Moreover, for certain types of securities, which finance specific projects contributing to environmental or social objectives the overall investment is considered to contribute to environmental and/or social objectives, but also for these a DNSH as well as a Good Governance check for issuers is performed.

● **How do the sustainable investments that the financial product partially intends to make, not cause significant harm to any environmental or social sustainable investment objective?**

In order to ensure that Sustainable Investments do not significantly harm any other environmental and/or social objective, the Investment Manager is leveraging the PAI indicators, whereby significance thresholds have been defined to identify significantly harmful issuers. Issuers not meeting the significance threshold can be engaged for a limited time period to remediate the adverse impact. Otherwise, if the issuer does not meet the defined significance thresholds twice subsequently or in case of a failed engagement, it does not pass the DNSH assessment. Investments in securities of issuers which do not pass the DNSH assessment are not counted as sustainable investments.

● *How have the indicators for adverse impacts on sustainability factors been taken into account?*

All mandatory PAI indicators are considered either as part of the application of the exclusion criteria or through thresholds on a sectorial or absolute basis. Significance thresholds have been defined and they refer to qualitative or quantitative criteria.

Recognizing the lack of data coverage for some of the PAI indicators equivalent data points are used to assess PAI indicators when applying the DNSH assessment, when relevant, for the following indicators for corporates: share of non-renewable energy consumption and production, activities negatively affecting biodiversity-sensitive areas, emissions to water, lack of processes and compliance mechanisms to monitor compliance with UNGC principles and OECD Guidelines for Multinational Enterprises; for sovereigns: GHG Intensity and investee countries subject to social violations. In case of securities which finance specific projects contributing to environmental or social objectives equivalent data at project level might be used to ensure that Sustainable Investments do not significantly harm any other environmental and/or social objective. The Investment Manager will strive to increase data coverage for PAI indicators with low data coverage by engaging with issuers and data providers. The Investment Manager will regularly evaluate whether the availability of data has increased sufficiently to potentially include assessment of such data in the investment process.

● *How are the sustainable investments aligned with the OECD Guidelines for Multinational Enterprises and the UN Guiding Principles on Business and Human Rights? Details:*

The Investment Manager’s sustainable minimum exclusion list screens out companies based on their involvement in controversial practices against international norms. The core normative framework consists of the Principles of the UN Global Compact, the OECD Guidelines for Multinational Enterprises

Principal adverse impacts are the most significant negative impacts of investment decisions on sustainability factors relating to environmental, social and employee matters, respect for human rights, anti-corruption and anti-bribery matters.

and the UN Guiding Principles for Business and Human Rights. Securities issued by companies having a severe violation of these frameworks will be restricted from the investment universe.

The EU Taxonomy sets out a “do not significant harm” principle by which Taxonomy-aligned investments should not significantly harm EU Taxonomy objectives and is accompanied by specific EU criteria.

The “do not significant harm” principle applies only to those investments underlying the financial product that take into account the EU criteria for environmentally sustainable economic activities. The investments underlying the remaining portion of this financial product do not take into account the EU criteria for environmentally sustainable economic activities.

Any other sustainable investments must also not significantly harm any environmental or social objectives.



Does this financial product consider principal adverse impacts on sustainability factors?

Yes

No

The Management Company has joined the Net Zero Asset Manager Initiative and considers PAI indicators through stewardship including engagement, both are relevant to mitigate potential adverse impact as a company.

Due to the commitment to the Net Zero Asset Manager Initiative, the Management Company aims to reduce greenhouse gas emissions in partnership with asset owner clients on decarbonisation goals, consistent with an ambition to reach net zero emission by 2050 or sooner across all assets under management. As part of this objective the Management Company will set an interim target for the proportion of assets to be managed in line with the attainment of net zero emissions by 2050 or sooner.

The Sub-Fund’s Investment Manager considers PAI indicators regarding greenhouse gas emission, biodiversity, water, waste as well as social and employee matters for corporate issuers, and, where relevant, the freedom house index is applied to investments in sovereigns. PAI indicators are considered within the Investment Manager’s investment process through the means of exclusions as described in the “binding elements” section of the Sub-Fund.

The data coverage for the data required for the PAI indicators is heterogenous. The data coverage related to biodiversity, water and waste is low and the related PAI indicators are considered through exclusion of securities issued by companies having a severe violation / breach of principles and guidelines such as the Principles of the United Nations Global Compact, the OECD Guidelines for Multinational Enterprises, and the United Nations Guiding Principles for Business and Human Rights on the grounds of problematic practices around human rights, labour rights, environment, and corruption issues. Therefore, the Investment Manager will strive to increase data coverage for PAI indicators with low data coverage. The Investment Manager will regularly evaluate whether the availability of data has increased sufficiently to potentially include assessment of such data in the investment process.

Additionally, PAI indicators are, among other sustainability factors, applied to derive the SRI Rating. The SRI Rating is used for the portfolio construction.

The following PAI indicators are considered:

Applicable to corporate issuers

- GHG Emissions
- Carbon footprint
- GHG Intensity of investee companies
- Exposure to companies active in the fossil fuel sector
- Activities negatively affecting biodiversity-sensitive areas
- Emissions to water
- Hazardous waste ratio
- Violation of UN Global compact principles
- Lack of processes and compliance mechanisms to monitor compliance with UN Global Compact principles
- Board gender diversity
- Exposure to controversial weapons

Applicable to sovereign and supranational issuers

- Investee countries subject to social violations

The information on the PAI indicators will be available in the end-year report of the Sub-Fund.



The investment strategy guides investment decisions based on factors such as investment objectives and risk tolerance.

What investment strategy does this financial product follow?

Allianz Short Duration Global Bond SRI's investment objective is to invest in global Bond Markets in accordance with the Sustainable and Responsible Investment Strategy (SRI Strategy).

As part of the SRI best-in-class approach, the Sub-Fund takes environmental, social, human rights, governance, and business behaviour factors into account as follows:

- The aforesaid sustainability factors are analysed through SRI Research by the Investment Manager in order to assess how sustainable development and long-term issues are taken into account in the strategy of an issuer. SRI Research means the overall process of identifying potential risks as well as potential opportunities of an investment in securities of an issuer related to the analysis of sustainability factors. SRI Research data combines external research data (which might have some limitations) with internal analyses.
- Based on a combination of the results of the external and/or internal analyses of the sustainability factors, an internal rating is derived monthly (SRI Rating) and is afterwards assigned to a corporate or sovereign issuer.

This internal SRI Rating is used to rank and select or weight securities for the portfolio construction.

The Sub-Fund's general investment approach (Sub-Fund's applicable General Asset Class Principles in combination with its individual investment restrictions) is described in the prospectus.

● What are the binding elements of the investment strategy used to select the investments to attain each of the environmental or social characteristics promoted by this financial product?

The binding elements are:

- Minimum rating coverage: At least 90% of the Sub-Fund's portfolio is required to have an SRI Rating (portfolio in this respect does not comprise non-rated derivatives and instruments that are non-rated by nature e.g., cash and deposits). While most holdings of the Sub-Fund will have a corresponding SRI Rating some investments cannot be rated according to the SRI Research methodology. Examples of instruments not attaining to the SRI Rating include, but are not limited to cash, deposits, Target Funds, and non-rated investments.
- At least 80% of the rated instruments are adhering to the minimum rating threshold of 1,75 (out of a rating scale from 0 – 4; 0 being the worst rating and 4 the best rating), and maximum 20% adhering to a minimum rating threshold between 1 and 1,75.
- Application of the following sustainable minimum exclusion criteria for direct investments:
 - securities issued by companies having a severe violation / breach of principles and guidelines such as the Principles of the United Nations Global Compact, the OECD Guidelines for Multinational Enterprises, and the United Nations Guiding Principles for Business and Human Rights on the grounds of problematic practices around human rights, labour rights, environment, and corruption issues,
 - securities issued by companies involved in controversial weapons (anti-personnel mines, cluster munitions, chemical weapons, biological weapons, depleted uranium, white phosphorus, and nuclear weapons),
 - securities issued by companies that derive more than 10% of their revenues from weapons, military equipment, and services,
 - securities issued by companies that derive more than 10% of their revenue from thermal coal extraction,
 - securities issued by utility companies that generate more than 20% of their revenues from coal,
 - securities issued by companies involved in the production of tobacco, and securities issued by companies involved in the distribution of tobacco with more than 5% of their revenues.

The following Sub-Fund specific exclusion criteria for direct investments apply:

- Sub-Fund assets may not be invested in Debt Securities of issuers which provide services in relation to tobacco of more than 10% of their revenues

- Sub-fund assets may not be invested in Debt Securities of issuers which are involved in the production of gambling and/or pornography and/or which are involved in the distribution/sales of gambling and/or pornography of more than 10% of their revenues and/or which provide services in relation to gambling and/or pornography of more than 10% of their revenues
- Sub-fund assets may not be invested in Debt Securities of issuers which are involved in the production of non-conventional oil and gas and/or which provide services in relation to non-conventional oil and gas of more than 10% of their revenues
- Sub-fund assets may not be invested in Debt Securities of issuers which are involved in the production of alcohol and/or which are involved in the distribution/sales of alcohol of more than 10% of their revenues and/or which provide services in relation to alcohol of more than 20% of their revenues

Direct investments in sovereign issuers with an insufficient freedom house index score are excluded.

The sustainable minimum exclusion criteria are based on information from an external data provider and coded in pre- and post-trade compliance. The review is performed at least half yearly.

● **What is the committed minimum rate to reduce the scope of the investments considered prior to the application of that investment strategy?**

The Sub-Fund does not commit to reduce the scope of the investments by a certain minimum rate.

● **What is the policy to assess good governance practices of the investee companies?**

Good governance principles are considered by screening out companies based on their involvement in controversies around international norms corresponding to the four good governance practices: sound management structures, employee relations, remuneration of staff and tax compliance. Companies having a severe violation in either of those areas will not be investible. For certain cases, flagged issuers shall be on a watch list. These companies will appear on this watch list when the Investment Manager believes that engagement may lead to improvements or when the company is assessed to take remedial actions. Companies on the watch list remain investible unless the Investment Manager believes that the engagement or the remedial actions of the company does not lead to the desired remedy of the severe controversy.

In addition, the Sub-Fund's Investment Manager is committed to actively encourage open dialogues with investee companies on corporate governance, proxy voting and broader sustainability issues in advance of shareholder meetings (regularly for direct investments in shares). The Sub-Fund's Investment Manager's approach to proxy voting and company engagement is set out in the Management Company's Stewardship Statement.

Good governance practices include sound management structures, employee relations, remuneration of staff and tax compliance.



What is the asset allocation planned for this financial product?

Asset allocation describes the share of investments in specific assets.

Min. 90% of the Sub-Funds' assets (excluding cash and non-rated derivatives) are used to meet the environmental or social characteristics promoted by this Sub-Fund. A low portion of the Sub-Fund might contain assets which do not promote environmental or social characteristics. Examples of such instruments are derivatives, cash and deposits, some Target Funds and investment with temporarily divergent or absent environmental, social, or good governance qualifications. Min. 10% of the Sub-Funds' assets will be invested in Sustainable Investments. The minimum percentage of investments that are aligned with the EU Taxonomy is 0.01%. The Sub-Fund's Investment Manager does not commit to a minimum share of environmentally Sustainable Investments that are not aligned with the EU Taxonomy. The Sub-Fund's Investment Manager does not commit to a minimum share of socially sustainable investments. While the Sub-Fund cannot commit to a minimum share of environmentally or socially sustainable investments, such investments may be freely allocated to within the Sub-Fund aggregated sustainable investment commitment disclosed (min. 10%).

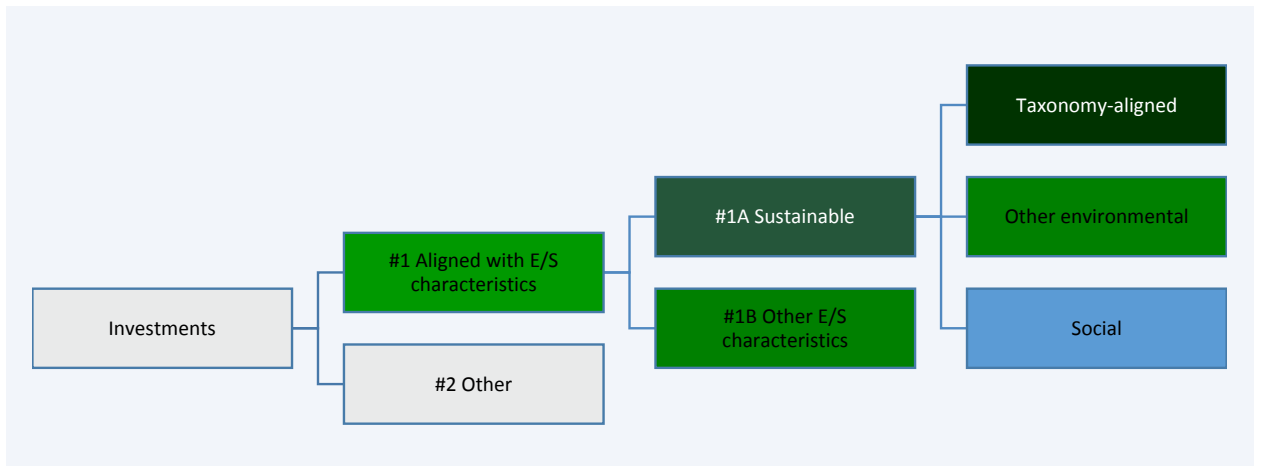

#1 Aligned with E/S characteristics includes the investments of the financial product used to attain the environmental or social characteristics promoted by the financial product.

#2 Other includes the remaining investments of the financial product which are neither aligned with the environmental or social characteristics, nor are qualified as sustainable investments.

The category #1 Aligned with E/S characteristics covers:

- The sub-category #1A Sustainable covers sustainable investments with environmental or social objectives.
- The sub-category #1B Other E/S characteristics covers investments aligned with the environmental or social characteristics that do not qualify as sustainable investments.

● **How does the use of derivatives attain the environmental or social characteristics promoted by the financial product?**

Not applicable



To what minimum extent are sustainable investments with an environmental objective aligned with the EU Taxonomy?

The Taxonomy-aligned investments include debt and/or equity in environmentally sustainable economic activities aligned with the EU-Taxonomy. The minimum percentage of investments that are aligned with the EU Taxonomy is 0.01%. Taxonomy-aligned data is provided by an external data provider. The Investment Manager has assessed the quality of such data. The data will not be subject to an assurance provided by auditors or a review by third parties. The data will not reflect any data in government bonds. As of today, there is no recognized methodology available to determine the proportion of Taxonomy-aligned activities when investing in government bonds.

Taxonomy-aligned activities in this disclosure are based on share of turnover. Pre-contractual figures use turnover as its financial metric as a default in line with the regulatory requirements and based on the fact that complete, verifiable or up-to date data for CAPEX and/or OPEX as financial metric is even less available.

Taxonomy-aligned data is only in rare cases data reported by companies in accordance with the EU Taxonomy. The data provider has derived Taxonomy-aligned data from other available equivalent public data.

● **Does the financial product invest in fossil gas and/or nuclear energy related activities that comply with the EU Taxonomy ¹?**

- Yes:
 - In fossil gas
 - In nuclear energy
- No

The Sub-Fund does not pursue any investments in fossil gas and/or nuclear energy related activities that comply with the EU Taxonomy. Nevertheless, as result of this investment strategy, investments may occur in corporates which are also active in these activities. Further information will be provided as part of the annual reporting, if relevant.

Taxonomy-aligned activities are expressed as a share of:
 - **turnover** reflecting the share of revenue from green activities of investee companies
 - **capital expenditure (CapEx)** showing the green investments made by investee companies, e.g. for a transition to a green

¹ Fossil gas and/or nuclear related activities will only comply with the EU Taxonomy where they contribute to limiting climate change ("climate change mitigation") and do not significantly harm any EU Taxonomy objective - see explanatory note in the left hand margin. The full criteria for fossil gas and nuclear energy economic activities that comply with the EU Taxonomy are laid down in Commission Delegated Regulation (EU) 2022/1214.

economy.
 - **operational expenditure (OpEx)** reflecting green operational activities of investee companies.

The two graphs below show in green the minimum percentage of investments that are aligned with the EU Taxonomy. As there is no appropriate methodology to determine the Taxonomy-alignment of sovereign bonds*, the first graph shows the Taxonomy-alignment in relation to all the investments of the financial product including sovereign bonds, while the second graph shows the Taxonomy-alignment only in relation to the investments of the financial product other than sovereign bonds.

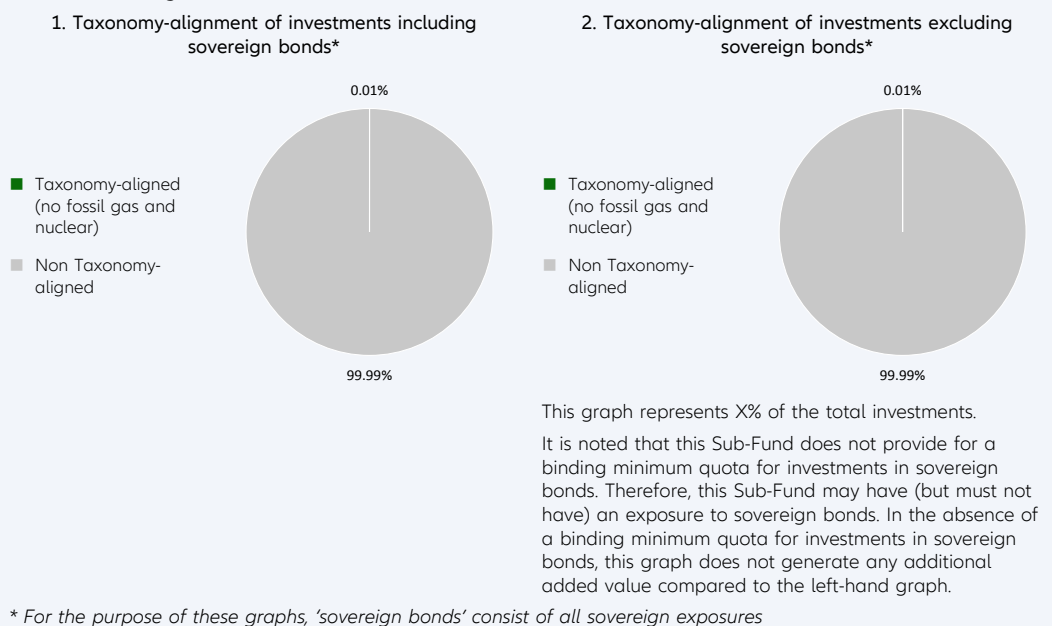

Enabling activities directly enable other activities to make a substantial contribution to an environmental objective.

● **What is the minimum share of investments in transitional and enabling activities?**

The Sub-Fund's Investment Manager does not commit to a split of minimum taxonomy alignment into transitional, enabling activities and own performance.

Transitional activities are activities for which low-carbon alternatives are not yet available and among others have greenhouse gas emission levels corresponding to the best performance.



What is the minimum share of sustainable investments with an environmental objective that are not aligned with the EU Taxonomy?

Taxonomy-aligned investments are considered a sub-category of Sustainable Investments. If an investment is not Taxonomy-aligned since the activity is not yet covered under the EU Taxonomy or the positive contribution is not substantial enough to comply with the Taxonomy technical screening criteria, the investment can still be considered an environmentally Sustainable Investment provided it complies with all criteria. The Investment Manager does not commit to a minimum share of environmentally Sustainable Investments that are not aligned with the EU Taxonomy. The overall sustainable investment share may also include investments with an environmental objective in economic activities that do not qualify as environmentally sustainable under the EU Taxonomy, and while the Sub-Fund cannot commit to a minimum share of environmentally or socially sustainable investments, such investments may be freely allocated to within the Sub-Fund aggregated sustainable investment commitment disclosed (min 10%).

are sustainable investments with an environmental objective that **do not take into account the criteria** for environmentally sustainable economic activities under the EU Taxonomy.



What is the minimum share of socially sustainable investments?

The Investment Manager defines Sustainable Investments based on internal research, which uses, among others, the UN Sustainable Development Goals (SDGs), as well as the objectives of the EU Taxonomy as reference frameworks. The Investment Manager does not commit to a minimum share of socially Sustainable Investments, as the SDGs contain environmental as well as social objectives. The overall sustainable investment share may also include investments with a social objective, and while the Sub-Fund cannot commit to a minimum share of environmentally or socially sustainable investments, such investments may be freely allocated to within the Sub-Fund aggregated sustainable investment commitment disclosed (min 10%).



What investments are included under “#2 Other”, what is their purpose and are there any minimum environmental or social safeguards?

Under “#2 Other” investments into cash, Target Funds, or derivatives can be included. Derivatives might be used for efficient portfolio management (including risk hedging) and/or investment purposes, and Target Funds to benefit from a specific strategy. For those investments no environmental or social safeguards are applied.



Is a specific index designated as a reference benchmark to determine whether this financial product is aligned with the environmental and/or social characteristics that it promotes?

No reference benchmark has been designated for the purpose of attaining the environmental and/or social characteristics promoted by the Sub-Fund.

Reference benchmarks are indexes to measure whether the financial product attains the environmental or social characteristics that they promote.

- **How is the reference benchmark continuously aligned with each of the environmental or social characteristics promoted by the financial product?**
Not applicable
- **How is the alignment of the investment strategy with the methodology of the index ensured on a continuous basis?**
Not applicable
- **How does the designated index differ from a relevant broad market index?**
Not applicable
- **Where can the methodology used for the calculation of the designated index be found?**
Not applicable



Where can I find more product specific information online?

More product-specific information can be found on the website: <https://regulatory.allianzgi.com/SFDR>

Template pre-contractual disclosure for the financial products referred to in Article 8, paragraphs 1, 2 and 2a, of Regulation (EU) 2019/2088 and Article 6, first paragraph, of Regulation (EU) 2020/852

Product name:

Allianz Smart Energy

Legal entity identifier: 5299001HEJY28N2P7I26

Environmental and/or social characteristics

Sustainable investment means an investment in an economic activity that contributes to an environmental or social objective, provided that the investment does not significantly harm any environmental or social objective and that the investee companies follow good governance practices.

The EU Taxonomy is a classification system laid down in Regulation (EU) 2020/852, establishing a list of environmentally sustainable economic activities. That Regulation does not include a list of socially sustainable economic activities. Sustainable investments with an environmental objective might be aligned with the Taxonomy or not.

Does this financial product have a sustainable investment objective?	
<input checked="" type="radio"/> <input checked="" type="radio"/> Yes	<input checked="" type="radio"/> <input type="radio"/> No
<input type="checkbox"/> It will make a minimum of sustainable investments with an environmental objective: ___% <ul style="list-style-type: none"> <input type="checkbox"/> in economic activities that qualify as environmentally sustainable under the EU Taxonomy <input type="checkbox"/> in economic activities that do not qualify as environmentally sustainable under the EU Taxonomy 	<input checked="" type="checkbox"/> It promotes Environmental/Social (E/S) characteristics and while it does not have as its objective a sustainable investment, it will have a minimum proportion of 50.00% of sustainable investments <ul style="list-style-type: none"> <input checked="" type="checkbox"/> with an environmental objective in economic activities that qualify as environmentally sustainable under the EU Taxonomy <input checked="" type="checkbox"/> with an environmental objective in economic activities that do not qualify as environmentally sustainable under the EU Taxonomy <input checked="" type="checkbox"/> with a social objective
<input type="checkbox"/> It will make a minimum of sustainable investments with a social objective ___% <ul style="list-style-type: none"> <input type="checkbox"/> It promotes E/S characteristics, but will not make any sustainable investments 	



What environmental and/or social characteristics are promoted by this financial product?

Allianz Smart Energy's (the "Sub-Fund") invests in securities of companies providing products or services which contribute to environmental or social objectives, as defined by the UN Sustainable Development Goals (SDGs) or the EU Taxonomy objectives, which are also related to the SDGs. The contribution is measured according to the Sustainable Investment methodology.

In addition, sustainable minimum exclusion criteria apply.

No reference benchmark has been designated for the purpose of attaining the environmental and/or social characteristics promoted by the Sub-Fund.

What sustainability indicators are used to measure the attainment of each of the environmental or social characteristics promoted by this financial product?

To measure the attainment of the Sub-Fund's sustainable investment objective the following sustainability indicators are used and reported on, at the fiscal year end:

- The actual Sustainable Investment share – which is based on SDGs or EU Taxonomy objectives
- Principle Adverse Impacts (PAIs) of investment decisions on sustainability factors are considered through the application of exclusion criteria.

Sustainability indicators measure how the environmental or social characteristics promoted by the financial product are attained.

- **What are the objectives of the sustainable investments that the financial product partially intends to make and how does the sustainable investment contribute to such objectives?**

Sustainable investments contribute to environmental and/or social objectives, for which the Investment Manager uses as reference frameworks, among others, the UN Sustainable Development Goals (SDGs), as well as the objectives of the EU Taxonomy:

1. Climate Change Mitigation
2. Climate Change Adaptation
3. Sustainable Use and Protection of Water and Marine Resources
4. Transition to a Circular Economy
5. Pollution Prevention and Control
6. Protection and Restoration of Biodiversity and Ecosystems

The assessment of the positive contribution to the environmental or social objectives is based on a proprietary framework which combines quantitative elements with qualitative inputs from internal research. The methodology applies first a quantitative breakdown of a securities issuer into its business activities. The qualitative element of the framework is an assessment if business activities contribute positively to an environmental or a social objective.

To calculate the positive contribution on the Sub-Fund level the revenue share of each issuer attributable to business activities contributing to environmental and/or social objectives is considered provided the issuer is satisfying the Do No Significant Harm (“DNSH”) and Good Governance principles, and an asset-weighted aggregation is performed as a second step. Moreover, for certain types of securities, which finance specific projects contributing to environmental or social objectives the overall investment is considered to contribute to environmental and/or social objectives, but also for these a DNSH as well as a Good Governance check for issuers is performed.

- **How do the sustainable investments that the financial product partially intends to make, not cause significant harm to any environmental or social sustainable investment objective?**

In order to ensure that Sustainable Investments do not significantly harm any other environmental and/or social objective, the Investment Manager is leveraging the PAI indicators, whereby significance thresholds have been defined to identify significantly harmful issuers. Issuers not meeting the significance threshold can be engaged for a limited time period to remediate the adverse impact. Otherwise, if the issuer does not meet the defined significance thresholds twice subsequently or in case of a failed engagement, it does not pass the DNSH assessment. Investments in securities of issuers which do not pass the DNSH assessment are not counted as sustainable investments.

- *How have the indicators for adverse impacts on sustainability factors been taken into account?*

All mandatory PAI indicators are considered either as part of the application of the exclusion criteria or through thresholds on a sectorial or absolute basis. Significance thresholds have been defined and they refer to qualitative or quantitative criteria.

Recognizing the lack of data coverage for some of the PAI indicators equivalent data points are used to assess PAI indicators when applying the DNSH assessment, when relevant, for the following indicators for corporates: share of non-renewable energy consumption and production, activities negatively affecting biodiversity-sensitive areas, emissions to water, lack of processes and compliance mechanisms to monitor compliance with UNGC principles and OECD Guidelines for Multinational Enterprises; for sovereigns: GHG Intensity and investee countries subject to social violations. In case of securities which finance specific projects contributing to environmental or social objectives equivalent data at project level might be used to ensure that Sustainable Investments do not significantly harm any other environmental and/or social objective. The Investment Manager will strive to increase data coverage for PAI indicators with low data coverage by engaging with issuers and data providers. The Investment Manager will regularly evaluate whether the availability of data has increased sufficiently to potentially include assessment of such data in the investment process.

- *How are the sustainable investments aligned with the OECD Guidelines for Multinational Enterprises and the UN Guiding Principles on Business and Human Rights? Details:*

The Investment Manager’s sustainable minimum exclusion list screens out companies based on their involvement in controversial practices against international norms. The core normative framework consists of the Principles of the UN Global Compact, the OECD Guidelines for Multinational Enterprises

Principal adverse impacts are the most significant negative impacts of investment decisions on sustainability factors relating to environmental, social and employee matters, respect for human rights, anti-corruption and anti-bribery matters.

and the UN Guiding Principles for Business and Human Rights. Securities issued by companies having a severe violation of these frameworks will be restricted from the investment universe.

The EU Taxonomy sets out a “do not significant harm” principle by which Taxonomy-aligned investments should not significantly harm EU Taxonomy objectives and is accompanied by specific EU criteria.

The “do not significant harm” principle applies only to those investments underlying the financial product that take into account the EU criteria for environmentally sustainable economic activities. The investments underlying the remaining portion of this financial product do not take into account the EU criteria for environmentally sustainable economic activities.

Any other sustainable investments must also not significantly harm any environmental or social objectives.



Does this financial product consider principal adverse impacts on sustainability factors?

Yes

No

The Management Company has joined the Net Zero Asset Manager Initiative and considers PAI indicators through stewardship including engagement, both are relevant to mitigate potential adverse impact as a company.

Due to the commitment to the Net Zero Asset Manager Initiative, the Management Company aims to reduce greenhouse gas emissions in partnership with asset owner clients on decarbonisation goals, consistent with an ambition to reach net zero emission by 2050 or sooner across all assets under management. As part of this objective the Management Company will set an interim target for the proportion of assets to be managed in line with the attainment of net zero emissions by 2050 or sooner.

The Sub-Fund’s Investment Manager considers PAI indicators regarding greenhouse gas emission, biodiversity, water, waste as well as social and employee matters for corporate issuers, and, where relevant, the freedom house index is applied to investments in sovereigns. PAI indicators are considered within the Investment Manager’s investment process through the means of exclusions as described in the “binding elements” section of the Sub-Fund.

The data coverage for the data required for the PAI indicators is heterogenous. The data coverage related to biodiversity, water and waste is low and the related PAI indicators are considered through exclusion of securities issued by companies having a severe violation / breach of principles and guidelines such as the Principles of the United Nations Global Compact, the OECD Guidelines for Multinational Enterprises, and the United Nations Guiding Principles for Business and Human Rights on the grounds of problematic practices around human rights, labour rights, environment, and corruption issues. Therefore, the Investment Manager will strive to increase data coverage for PAI indicators with low data coverage. The Investment Manager will regularly evaluate whether the availability of data has increased sufficiently to potentially include assessment of such data in the investment process.

Additionally, PAI indicators are considered as part of the requirement of the Sub-Fund to invest 50% into Sustainable Investments. PAI indicators are used as part of the DNSH assessment. Investments in securities of issuers who do not pass the DNSH assessment are not counted as sustainable investments.

The following PAI indicators are considered:

Applicable to corporate issuers

- GHG Emissions
- Carbon footprint
- GHG Intensity of investee companies
- Exposure to companies active in the fossil fuel sector
- Share of non-renewable energy consumption and production
- Energy consumption intensity per high impact climate sector
- Activities negatively affecting biodiversity-sensitive areas
- Emissions to water
- Hazardous waste ratio
- Violation of UN Global compact principles

- Lack of processes and compliance mechanisms to monitor compliance with UN Global Compact principles
- Unadjusted gender pay gap
- Board gender diversity
- Exposure to controversial weapons

Applicable to sovereign and supranational issuers

- GHG Intensity
- Investee countries subject to social violations

The information on the PAI indicators will be available in the end-year report of the Sub-Fund.



What investment strategy does this financial product follow?

The investment strategy guides investment decisions based on factors such as investment objectives and risk tolerance.

Allianz Smart Energy's investment objective is to invest in global Equity Markets with a focus on companies with an engagement in the area of transition of energy usage in accordance with the SDG-Aligned Strategy.

The Sub-Fund invests in Equities of companies which offer products and services across themes of transition of energy usage. Companies which engage in the transition of energy usage are companies which offer products or services with active positive contribution to the shift away from fossil fuels, enhancing resilience of the sustainable energy infrastructure, creating renewable sources of energy generation, energy storage systems and improving efficacy and access to energy consumption, as targeted by the SDGs No. 7, 9, 11, 12, and 13.

The Sub-Fund's general investment approach (Sub-Fund's applicable General Asset Class Principles in combination with its individual investment restrictions) is described in the prospectus.

● What are the binding elements of the investment strategy used to select the investments to attain each of the environmental or social characteristics promoted by this financial product?

The binding elements are:

- Minimum 50% of the Sub-Fund assets' weighted average shall result from revenue generated from issuers' activities that facilitate the achievement of one or more SDG or EU Taxonomy objectives as measured according to the Sustainable Investment methodology.
- For at least 80% of the Sub-Fund portfolio, the respective issuer shall have a minimum share of 20% Sustainable Investments. Cash and derivatives are excluded from the aforesaid thresholds.
- Application of the below sustainable minimum exclusion criteria for direct investments and Sub-Fund specific exclusion criteria.

The following sustainable minimum exclusion criteria for direct investments apply:

- securities issued by companies having a severe violation / breach of principles and guidelines such as the Principles of the United Nations Global Compact, the OECD Guidelines for Multinational Enterprises, and the United Nations Guiding Principles for Business and Human Rights on the grounds of problematic practices around human rights, labour rights, environment, and corruption issues,
- securities issued by companies involved in controversial weapons (anti-personnel mines, cluster munitions, chemical weapons, biological weapons, depleted uranium, white phosphorus, and nuclear weapons),
- securities issued by companies that derive more than 10% of their revenues from weapons, military equipment, and services,
- securities issued by companies that derive more than 10% of their revenue from thermal coal extraction,
- securities issued by utility companies that generate more than 20% of their revenues from coal,
- securities issued by companies involved in the production of tobacco, and securities issued by companies involved in the distribution of tobacco with more than 5% of their revenues.

The following Sub-Fund specific exclusion criteria for direct investments apply:

- Sub-Fund assets must not be invested in companies whose revenues exceed 30% origin from upstream oil or coal mining or power generation from these fuels.

The sustainable minimum exclusion criteria, as well as the Sub-Fund specific exclusion criteria, are based on information from an external data provider and coded in pre- and post-trade compliance. The review is performed at least half yearly.

● **What is the committed minimum rate to reduce the scope of the investments considered prior to the application of that investment strategy?**

The Sub-Fund does not commit to reduce the scope of the investments by a certain minimum rate.

● **What is the policy to assess good governance practices of the investee companies?**

Good governance principles are considered by screening out companies based on their involvement in controversies around international norms corresponding to the four good governance practices: sound management structures, employee relations, remuneration of staff and tax compliance. Companies having a severe violation in either of those areas will not be investible. For certain cases, flagged issuers shall be on a watch list. These companies will appear on this watch list when the Investment Manager believes that engagement may lead to improvements or when the company is assessed to take remedial actions. Companies on the watch list remain investible unless the Investment Manager believes that the engagement or the remedial actions of the company does not lead to the desired remedy of the severe controversy.

In addition, the Sub-Fund's Investment Manager is committed to actively encourage open dialogues with investee companies on corporate governance, proxy voting and broader sustainability issues in advance of shareholder meetings (regularly for direct investments in shares). The Sub-Fund's Investment Manager's approach to proxy voting and company engagement is set out in the Management Company's Stewardship Statement.

Good governance practices include sound management structures, employee relations, remuneration of staff and tax compliance.



What is the asset allocation planned for this financial product?

Asset allocation describes the share of investments in specific assets.

Min. 80% of the Sub-Funds' assets (excluding cash, and derivatives) are used to meet the environmental or social characteristics promoted by this Sub-Fund. A low portion of the Sub-Fund might contain assets which do not promote environmental or social characteristics. Example of such instruments are derivatives, cash and deposits, some Target Funds and investment with temporarily divergent or absent environmental, social, or good governance qualifications. The Sub-Fund invest primarily into securities which offer products and services to facilitate the achievements of the SDGs. Min. 50% of the Sub-Funds' assets will be invested in Sustainable Investments. The Sub-Fund's Investment Manager does not commit to a minimum share of sustainable investments with an environmental objective aligned with the EU Taxonomy nor to a minimum share of environmentally Sustainable Investments that are not aligned with the EU Taxonomy. The Sub-Fund's Investment Manager does not commit to a minimum share of socially sustainable investments. While the Sub-Fund cannot commit to a minimum share of environmentally or socially sustainable investments, such investments may be freely allocated to within the Sub-Fund aggregated sustainable investment commitment disclosed (min. 50%).

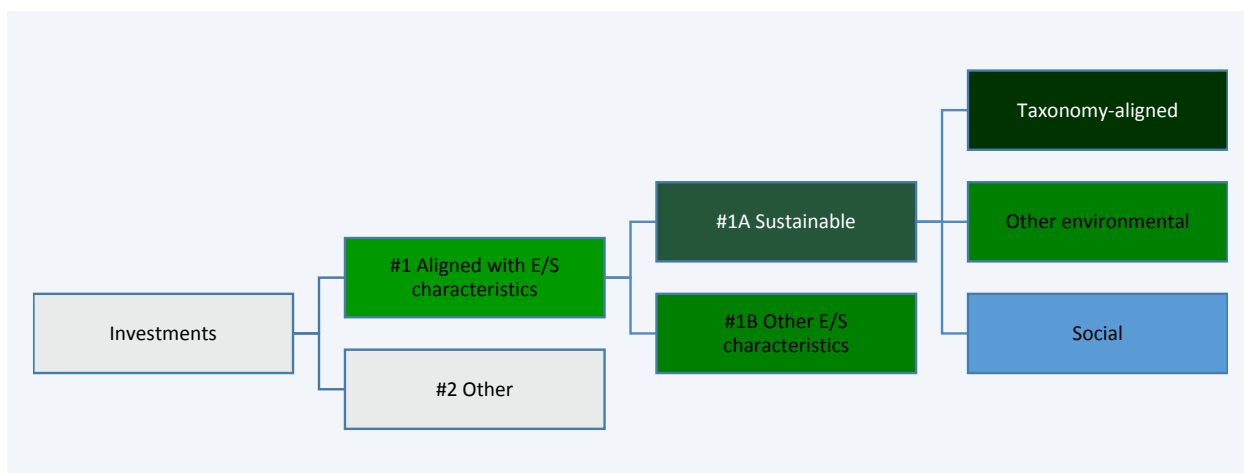

#1 Aligned with E/S characteristics includes the investments of the financial product used to attain the environmental or social characteristics promoted by the financial product.

#2 Other includes the remaining investments of the financial product which are neither aligned with the environmental or social characteristics, nor are qualified as sustainable investments.

The category #1 Aligned with E/S characteristics covers:
 - The sub-category #1A Sustainable covers sustainable investments with environmental or social objectives.
 - The sub-category #1B Other E/S characteristics covers investments aligned with the environmental or social characteristics that do not qualify as sustainable investments.

● **How does the use of derivatives attain the environmental or social characteristics promoted by the financial product?**

Not applicable



To what minimum extent are sustainable investments with an environmental objective aligned with the EU Taxonomy?

The Sub-Fund's Investment Manager does not commit to a minimum share of sustainable investments with an environmental objective aligned with the EU Taxonomy. The overall sustainable investment share may also include investments with an environmental objective in economic activities that qualify as environmentally sustainable under the EU Taxonomy.

● **Does the financial product invest in fossil gas and/or nuclear energy related activities that comply with the EU Taxonomy¹?**

- Yes:
 - In fossil gas
 - In nuclear energy
- No

The Sub-Fund does not pursue any investments in fossil gas and/or nuclear energy related activities that comply with the EU Taxonomy. Nevertheless, as result of this investment strategy, investments may occur in corporates which are also active in these activities. Further information will be provided as part of the annual reporting, if relevant.

The two graphs below show in green the minimum percentage of investments that are aligned with the EU Taxonomy. As there is no appropriate methodology to determine the Taxonomy-alignment of sovereign bonds, the first graph shows the Taxonomy-alignment in relation to all the investments of the financial product including sovereign bonds, while the second graph shows the Taxonomy-alignment only in relation to the investments of the financial product other than sovereign bonds.*

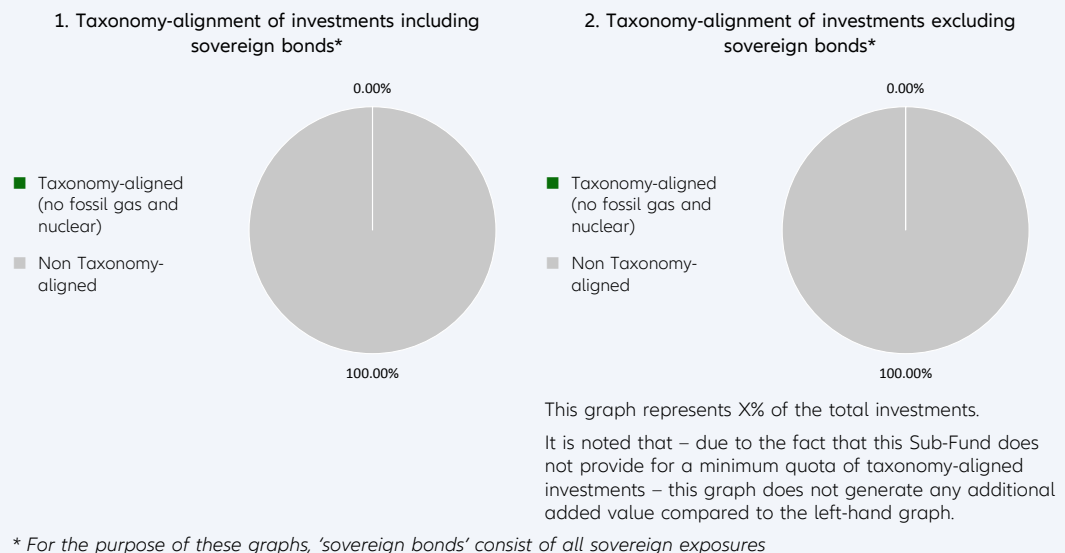

● **What is the minimum share of investments in transitional and enabling activities?**

The Sub-Fund's Investment Manager does not commit to a split of minimum taxonomy alignment into transitional, enabling activities and own performance.

Taxonomy-aligned activities are expressed as a share of:
 - **turnover** reflecting the share of revenue from green activities of investee companies
 - **capital expenditure (CapEx)** showing the green investments made by investee companies, e.g. for a transition to a green economy.
 - **operational expenditure (OpEx)** reflecting green operational activities of investee companies.

Enabling activities directly enable other activities to make a substantial contribution to an environmental objective.

¹ Fossil gas and/or nuclear related activities will only comply with the EU Taxonomy where they contribute to limiting climate change ("climate change mitigation") and do not significantly harm any EU Taxonomy objective - see explanatory note in the left hand margin. The full criteria for fossil gas and nuclear energy economic activities that comply with the EU Taxonomy are laid down in Commission Delegated Regulation (EU) 2022/1214.

Transitional activities are activities for which low-carbon alternatives are not yet available and among others have greenhouse gas emission levels corresponding to the best performance.



What is the minimum share of sustainable investments with an environmental objective that are not aligned with the EU Taxonomy?

Taxonomy-aligned investments are considered a sub-category of Sustainable Investments. If an investment is not Taxonomy-aligned since the activity is not yet covered under the EU Taxonomy or the positive contribution is not substantial enough to comply with the Taxonomy technical screening criteria, the investment can still be considered an environmentally Sustainable Investment provided it complies with all criteria. The Investment Manager does not commit to a minimum share of environmentally Sustainable Investments that are not aligned with the EU Taxonomy. The overall sustainable investment share may also include investments with an environmental objective in economic activities that do not qualify as environmentally sustainable under the EU Taxonomy, and while the Sub-Fund cannot commit to a minimum share of environmentally or socially sustainable investments, such investments may be freely allocated to within the Sub-Fund aggregated sustainable investment commitment disclosed (min. 50%).



are sustainable investments with an environmental objective that **do not take into account the criteria** for environmentally sustainable economic activities under the EU Taxonomy.



What is the minimum share of socially sustainable investments?

The Investment Manager defines Sustainable Investments based on internal research, which uses, among others, the UN Sustainable Development Goals (SDGs), as well as the objectives of the EU Taxonomy as reference frameworks. The Investment Manager does not commit to a minimum share of socially Sustainable Investments, as the SDGs contain environmental as well as social objectives. The overall sustainable investment share may also include investments with a social objective, and while the Sub-Fund cannot commit to a minimum share of environmentally or socially sustainable investments, such investments may be freely allocated to within the Sub-Fund aggregated sustainable investment commitment disclosed (min. 50%).



What investments are included under “#2 Other”, what is their purpose and are there any minimum environmental or social safeguards?

Under “#2 Other” investments into cash, Target Funds, or derivatives can be included. Derivatives might be used for efficient portfolio management (including risk hedging) and/or investment purposes, and Target Funds to benefit from a specific strategy. For those investments no environmental or social safeguards are applied.



Is a specific index designated as a reference benchmark to determine whether this financial product is aligned with the environmental and/or social characteristics that it promotes?

No reference benchmark has been designated for the purpose of attaining the environmental and/or social characteristics promoted by the Sub-Fund.

- **How is the reference benchmark continuously aligned with each of the environmental or social characteristics promoted by the financial product?**

Not applicable

Reference benchmarks are indexes to measure whether the financial product attains the environmental or social characteristics that they promote.

- How is the alignment of the investment strategy with the methodology of the index ensured on a continuous basis?
Not applicable
- How does the designated index differ from a relevant broad market index?
Not applicable
- Where can the methodology used for the calculation of the designated index be found?
Not applicable



Where can I find more product specific information online?

More product-specific information can be found on the website: <https://regulatory.allianzgi.com/SFDR>

Template pre-contractual disclosure for the financial products referred to in Article 8, paragraphs 1, 2 and 2a, of Regulation (EU) 2019/2088 and Article 6, first paragraph, of Regulation (EU) 2020/852

Product name:

Allianz Social Conviction Equity

Legal entity identifier: 529900RICS54KA4ZV927

Environmental and/or social characteristics

Sustainable investment means an investment in an economic activity that contributes to an environmental or social objective, provided that the investment does not significantly harm any environmental or social objective and that the investee companies follow good governance practices.

The **EU Taxonomy** is a classification system laid down in Regulation (EU) 2020/852, establishing a list of **environmentally sustainable economic activities**. That Regulation does not include a list of socially sustainable economic activities. Sustainable investments with an environmental objective might be aligned with the Taxonomy or not.

Does this financial product have a sustainable investment objective?	
<input checked="" type="radio"/> <input checked="" type="radio"/> Yes	<input type="radio"/> <input checked="" type="radio"/> No
<input type="checkbox"/> It will make a minimum of sustainable investments with an environmental objective: ___% <ul style="list-style-type: none"> <input type="checkbox"/> in economic activities that qualify as environmentally sustainable under the EU Taxonomy <input type="checkbox"/> in economic activities that do not qualify as environmentally sustainable under the EU Taxonomy 	<input checked="" type="checkbox"/> It promotes Environmental/Social (E/S) characteristics and while it does not have as its objective a sustainable investment, it will have a minimum proportion of 30.00% of sustainable investments <ul style="list-style-type: none"> <input checked="" type="checkbox"/> with an environmental objective in economic activities that qualify as environmentally sustainable under the EU Taxonomy <input checked="" type="checkbox"/> with an environmental objective in economic activities that do not qualify as environmentally sustainable under the EU Taxonomy <input checked="" type="checkbox"/> with a social objective
<input type="checkbox"/> It will make a minimum of sustainable investments with a social objective ___%	<input type="checkbox"/> It promotes E/S characteristics, but will not make any sustainable investments



What environmental and/or social characteristics are promoted by this financial product?

Allianz Social Conviction Equity (the Sub-Fund) promotes environmental, social, human rights, governance, and business behaviour factors (this domain does not apply for sovereigns issued by a Sovereign Entity) through integration of a best-in-class approach into the Sub-Fund's investment process. This encompasses the evaluation of corporate or sovereign issuers based on an SRI Rating which is used to construct the portfolio. The Sub-Fund will prioritize the social factor by investing in companies with a superior social profile, that are either companies (i) that provide products and/or services that have a positive social contribution (which includes, among other things, health and the welfare of society) and/or (ii) companies that are deemed to exhibit a superior social profile by the investment manager's discretionary assessment by taking into consideration both qualitative and quantitative social indicators.

In addition, sustainable minimum exclusion criteria apply.

No reference benchmark has been designated for the purpose of attaining the environmental and/or social characteristics promoted by the Sub-Fund.

What sustainability indicators are used to measure the attainment of each of the environmental or social characteristics promoted by this financial product?

To measure the attainment of the environmental and/or social characteristics the following sustainability indicators are used and reported on, at the fiscal year end:

- The actual percentage of the Sub-Fund's Portfolio (Portfolio in this respect does not comprise non-rated derivatives and instruments that are non-rated by nature (e. g., cash and deposits)) assets

Sustainability indicators measure how the environmental or social characteristics promoted by the financial product are attained.

invested in best-in-class issuers (issuers with a minimum SRI Rating of 2 out of a scale from 0-4; 0 being the worst rating and 4 the best rating) is compared to the actual percentage of the benchmarks best-in-class issuers.

- Adherence to a 20% reduction of the investment universe
 - Confirmation that Principal Adverse Impacts (PAIs) of investment decisions on sustainability factors are considered through the application of exclusion criteria.
- **What are the objectives of the sustainable investments that the financial product partially intends to make and how does the sustainable investment contribute to such objectives?**

Sustainable investments contribute to environmental and/or social objectives, for which the Investment Manager uses as reference frameworks, among others, the UN Sustainable Development Goals (SDGs), as well as the objectives of the EU Taxonomy:

1. Climate Change Mitigation
2. Climate Change Adaptation
3. Sustainable Use and Protection of Water and Marine Resources
4. Transition to a Circular Economy
5. Pollution Prevention and Control
6. Protection and Restoration of Biodiversity and Ecosystems

The assessment of the positive contribution to the environmental or social objectives is based on a proprietary framework which combines quantitative elements with qualitative inputs from internal research. The methodology applies first a quantitative breakdown of a securities issuer into its business activities. The qualitative element of the framework is an assessment if business activities contribute positively to an environmental or a social objective.

To calculate the positive contribution on the Sub-Fund level the revenue share of each issuer attributable to business activities contributing to environmental and/or social objectives is considered provided the issuer is satisfying the Do No Significant Harm (“DNSH”) and Good Governance principles, and an asset-weighted aggregation is performed as a second step. Moreover, for certain types of securities, which finance specific projects contributing to environmental or social objectives the overall investment is considered to contribute to environmental and/or social objectives, but also for these a DNSH as well as a Good Governance check for issuers is performed.

- **How do the sustainable investments that the financial product partially intends to make, not cause significant harm to any environmental or social sustainable investment objective?**

In order to ensure that Sustainable Investments do not significantly harm any other environmental and/or social objective, the Investment Manager is leveraging the PAI indicators, whereby significance thresholds have been defined to identify significantly harmful issuers. Issuers not meeting the significance threshold can be engaged for a limited time period to remediate the adverse impact. Otherwise, if the issuer does not meet the defined significance thresholds twice subsequently or in case of a failed engagement, it does not pass the DNSH assessment. Investments in securities of issuers which do not pass the DNSH assessment are not counted as sustainable investments.

- *How have the indicators for adverse impacts on sustainability factors been taken into account?*

All mandatory PAI indicators are considered either as part of the application of the exclusion criteria or through thresholds on a sectorial or absolute basis. Significance thresholds have been defined and they refer to qualitative or quantitative criteria.

Recognizing the lack of data coverage for some of the PAI indicators equivalent data points are used to assess PAI indicators when applying the DNSH assessment, when relevant, for the following indicators for corporates: share of non-renewable energy consumption and production, activities negatively affecting biodiversity-sensitive areas, emissions to water, lack of processes and compliance mechanisms to monitor compliance with UNGC principles and OECD Guidelines for Multinational Enterprises; for sovereigns: GHG Intensity and investee countries subject to social violations. In case of securities which finance specific projects contributing to environmental or social objectives equivalent data at project level might be used to ensure that Sustainable Investments do not significantly harm any other environmental and/or social objective. The Investment Manager will strive to increase data coverage for PAI indicators with low data coverage by engaging with issuers and data providers. The Investment

Principal adverse impacts are the most significant negative impacts of investment decisions on sustainability factors relating to environmental, social and employee matters, respect for human rights, anti-corruption and anti-bribery matters.

Manager will regularly evaluate whether the availability of data has increased sufficiently to potentially include assessment of such data in the investment process.

● *How are the sustainable investments aligned with the OECD Guidelines for Multinational Enterprises and the UN Guiding Principles on Business and Human Rights? Details:*

The Investment Manager's sustainable minimum exclusion list screens out companies based on their involvement in controversial practices against international norms. The core normative framework consists of the Principles of the UN Global Compact, the OECD Guidelines for Multinational Enterprises and the UN Guiding Principles for Business and Human Rights. Securities issued by companies having a severe violation of these frameworks will be restricted from the investment universe.

The EU Taxonomy sets out a "do not significant harm" principle by which Taxonomy-aligned investments should not significantly harm EU Taxonomy objectives and is accompanied by specific EU criteria.

The "do not significant harm" principle applies only to those investments underlying the financial product that take into account the EU criteria for environmentally sustainable economic activities. The investments underlying the remaining portion of this financial product do not take into account the EU criteria for environmentally sustainable economic activities.

Any other sustainable investments must also not significantly harm any environmental or social objectives.



Does this financial product consider principal adverse impacts on sustainability factors?

Yes

No

The Management Company has joined the Net Zero Asset Manager Initiative and considers PAI indicators through stewardship including engagement, both are relevant to mitigate potential adverse impact as a company.

Due to the commitment to the Net Zero Asset Manager Initiative, the Management Company aims to reduce greenhouse gas emissions in partnership with asset owner clients on decarbonisation goals, consistent with an ambition to reach net zero emission by 2050 or sooner across all assets under management. As part of this objective the Management Company will set an interim target for the proportion of assets to be managed in line with the attainment of net zero emissions by 2050 or sooner.

The Sub-Fund's Investment Manager considers PAI indicators regarding greenhouse gas emission, biodiversity, water, waste as well as social and employee matters for corporate issuers, and, where relevant, the freedom house index is applied to investments in sovereigns. PAI indicators are considered within the Investment Manager's investment process through the means of exclusions as described in the "binding elements" section of the Sub-Fund.

The data coverage for the data required for the PAI indicators is heterogenous. The data coverage related to biodiversity, water and waste is low and the related PAI indicators are considered through exclusion of securities issued by companies having a severe violation / breach of principles and guidelines such as the Principles of the United Nations Global Compact, the OECD Guidelines for Multinational Enterprises, and the United Nations Guiding Principles for Business and Human Rights on the grounds of problematic practices around human rights, labour rights, environment, and corruption issues. Therefore, the Investment Manager will strive to increase data coverage for PAI indicators with low data coverage. The Investment Manager will regularly evaluate whether the availability of data has increased sufficiently to potentially include assessment of such data in the investment process.

Additionally, PAI indicators are, among other sustainability factors, applied to derive the SRI Rating. The SRI Rating is used for the portfolio construction.

The following PAI indicators are considered:

Applicable to corporate issuers

- GHG Emissions
- Carbon footprint
- GHG Intensity of investee companies
- Exposure to companies active in the fossil fuel sector
- Activities negatively affecting biodiversity-sensitive areas

- Emissions to water
- Hazardous waste ratio
- Violation of UN Global compact principles
- Lack of processes and compliance mechanisms to monitor compliance with UN Global Compact principles
- Board gender diversity
- Exposure to controversial weapons

Applicable to sovereign and supranational issuers

- Investee countries subject to social violations

The information on the PAI indicators will be available in the end-year report of the Sub-Fund.



The investment strategy guides investment decisions based on factors such as investment objectives and risk tolerance.

What investment strategy does this financial product follow?

Allianz Social Conviction Equity's investment strategy is to invest in the Eurozone equity markets with a focus on companies that have a superior social profile in accordance with the Sustainable and Responsible Investment Strategy (SRI Strategy).

As part of the SRI best-in-class approach, the Sub-Fund takes environmental, social, human rights, governance, and business behaviour factors into account as follows:

- The aforesaid sustainability factors are analysed through SRI Research by the Investment Manager in order to assess how sustainable development and long-term issues are taken into account in the strategy of an issuer. SRI Research means the overall process of identifying potential risks as well as potential opportunities of an investment in securities of an issuer related to the analysis of sustainability factors. SRI Research data combines external research data (which might have some limitations) with internal analyses.
- Based on a combination of the results of the external and/or internal analyses of the sustainability factors, an internal rating is derived monthly (SRI Rating) and is afterwards assigned to a corporate or sovereign issuer.

This internal SRI Rating is used to rank and select or weight securities for the portfolio construction.

The Sub-Fund's general investment approach (Sub-Fund's applicable General Asset Class Principles in combination with its individual investment restrictions) is described in the prospectus.

● What are the binding elements of the investment strategy used to select the investments to attain each of the environmental or social characteristics promoted by this financial product?

The binding elements are:

- Minimum rating coverage: At least 90% of Sub-Fund's portfolio is required to have an SRI Rating (Portfolio in this respect does not comprise non-rated derivatives and instruments that are non-rated by nature e.g., cash and deposits). While most holdings of Sub-Funds will have a corresponding SRI Rating some investments cannot be rated according to the SRI Research methodology. Examples of instruments not attaining to the SRI Rating include, but are not limited to, cash, deposits, Target Funds and non-rated investments.
- The rated instruments are adhering to the minimum rating threshold of 2 (out of a rating scale from 0 – 4; 0 being the worst rating and 4 the best rating).
- Reduction of the investment universe by excluding the worst 20% rated issuers.
- Application of the below sustainable minimum exclusion criteria.

The following sustainable minimum exclusion criteria for direct investments:

- securities issued by companies having a severe violation / breach of principles and guidelines such as the Principles of the United Nations Global Compact, the OECD Guidelines for Multinational Enterprises, and the United Nations Guiding Principles for Business and Human Rights on the grounds of problematic practices around human rights, labour rights, environment, and corruption issues,
- securities issued by companies involved in controversial weapons (anti-personnel mines, cluster munitions, chemical weapons, biological weapons, depleted uranium, white phosphorus, and nuclear weapons),

- securities issued by companies that derive more than 10% of their revenues from weapons, military equipment, and services,
- securities issued by companies that derive more than 10% of their revenue from thermal coal extraction,
- securities issued by utility companies that generate more than 20% of their revenues from coal,
- securities issued by companies involved in the production of tobacco, and securities issued by companies involved in the distribution of tobacco with more than 5% of their revenues.

Direct investments in sovereign issuers with an insufficient freedom house index score are excluded.

The sustainable minimum exclusion criteria are based on information from an external data provider and coded in pre- and post-trade compliance. The review is performed at least half yearly.

● **What is the committed minimum rate to reduce the scope of the investments considered prior to the application of that investment strategy?**

The Sub-Fund commits to reduce the investment universe by at least 20%.

● **What is the policy to assess good governance practices of the investee companies?**

Good governance principles are considered by screening out companies based on their involvement in controversies around international norms corresponding to the four good governance practices: sound management structures, employee relations, remuneration of staff and tax compliance. Companies having a severe violation in either of those areas will not be investible. For certain cases, flagged issuers shall be on a watch list. These companies will appear on this watch list when the Investment Manager believes that engagement may lead to improvements or when the company is assessed to take remedial actions. Companies on the watch list remain investible unless the Investment Manager believes that the engagement or the remedial actions of the company does not lead to the desired remedy of the severe controversy.

In addition, the Sub-Fund's Investment Manager is committed to actively encourage open dialogues with investee companies on corporate governance, proxy voting and broader sustainability issues in advance of shareholder meetings (regularly for direct investments in shares). The Sub-Fund's Investment Manager's approach to proxy voting and company engagement is set out in the Management Company's Stewardship Statement.

Good governance practices include sound management structures, employee relations, remuneration of staff and tax compliance.



What is the asset allocation planned for this financial product?

Asset allocation describes the share of investments in specific assets.

Min. 90% of the Sub-Fund's assets (excluding cash and non-rated derivatives) are used to meet the environmental or social characteristics promoted by this Sub-Fund. A low portion of the Sub-Fund might contain assets which do not promote environmental or social characteristics. Examples of such instruments are derivatives, cash and deposits, some Target Funds and investment with temporarily divergent or absent environmental, social, or good governance qualifications. Min. 30% of the Sub-Funds' assets will be invested in Sustainable Investments. The minimum percentage of investments that are aligned with the EU Taxonomy is 0.01%. The Sub-Fund's Investment Manager does not commit to a minimum share of environmentally Sustainable Investments that are not aligned with the EU Taxonomy. The Sub-Fund's Investment Manager does not commit to a minimum share of socially sustainable investments. While the Sub-Fund cannot commit to a minimum share of environmentally or socially sustainable investments, such investments may be freely allocated to within the Sub-Fund aggregated sustainable investment commitment disclosed (min. 30%).

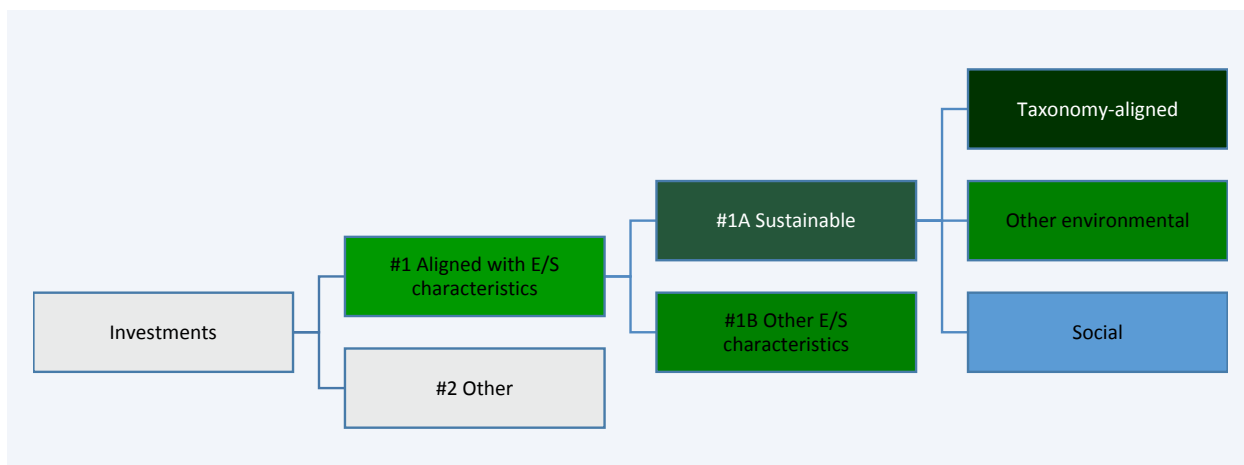

#1 Aligned with E/S characteristics includes the investments of the financial product used to attain the environmental or social characteristics promoted by the financial product.

#2 Other includes the remaining investments of the financial product which are neither aligned with the environmental or social characteristics, nor are qualified as sustainable investments.

The category **#1 Aligned with E/S characteristics** covers:

- The sub-category **#1A Sustainable** covers sustainable investments with environmental or social objectives.
- The sub-category **#1B Other E/S characteristics** covers investments aligned with the environmental or social characteristics that do not qualify as sustainable investments.

- **How does the use of derivatives attain the environmental or social characteristics promoted by the financial product?**

Not applicable



To what minimum extent are sustainable investments with an environmental objective aligned with the EU Taxonomy?

The Taxonomy-aligned investments include debt and/or equity in environmentally sustainable economic activities aligned with the EU-Taxonomy. The minimum percentage of investments that are aligned with the EU Taxonomy is 0.01%. Taxonomy-aligned data is provided by an external data provider. The Investment Manager has assessed the quality of such data. The data will not be subject to an assurance provided by auditors or a review by third parties. The data will not reflect any data in government bonds. As of today, there is no recognized methodology available to determine the proportion of Taxonomy-aligned activities when investing in government bonds.

Taxonomy-aligned activities in this disclosure are based on share of turnover. Pre-contractual figures use turnover as its financial metric as a default in line with the regulatory requirements and based on the fact that complete, verifiable or up-to date data for CAPEX and/or OPEX as financial metric is even less available.

Taxonomy-aligned data is only in rare cases data reported by companies in accordance with the EU Taxonomy. The data provider has derived Taxonomy-aligned data from other available equivalent public data.

- **Does the financial product invest in fossil gas and/or nuclear energy related activities that comply with the EU Taxonomy ¹?**

- Yes:
- In fossil gas In nuclear energy
- No

The Sub-Fund does not pursue any investments in fossil gas and/or nuclear energy related activities that comply with the EU Taxonomy. Nevertheless, as result of this investment strategy, investments may occur in corporates which are also active in these activities. Further information will be provided as part of the annual reporting, if relevant.

Taxonomy-aligned activities are expressed as a share of:

- **turnover** reflecting the share of revenue from green activities of investee companies
- **capital expenditure (CapEx)** showing the green investments made by investee companies, e.g. for a transition to a green

¹ Fossil gas and/or nuclear related activities will only comply with the EU Taxonomy where they contribute to limiting climate change ("climate change mitigation") and do not significantly harm any EU Taxonomy objective - see explanatory note in the left hand margin. The full criteria for fossil gas and nuclear energy economic activities that comply with the EU Taxonomy are laid down in Commission Delegated Regulation (EU) 2022/1214.

economy.
 - **operational expenditure (OpEx)** reflecting green operational activities of investee companies.

The two graphs below show in green the minimum percentage of investments that are aligned with the EU Taxonomy. As there is no appropriate methodology to determine the Taxonomy-alignment of sovereign bonds*, the first graph shows the Taxonomy-alignment in relation to all the investments of the financial product including sovereign bonds, while the second graph shows the Taxonomy-alignment only in relation to the investments of the financial product other than sovereign bonds.

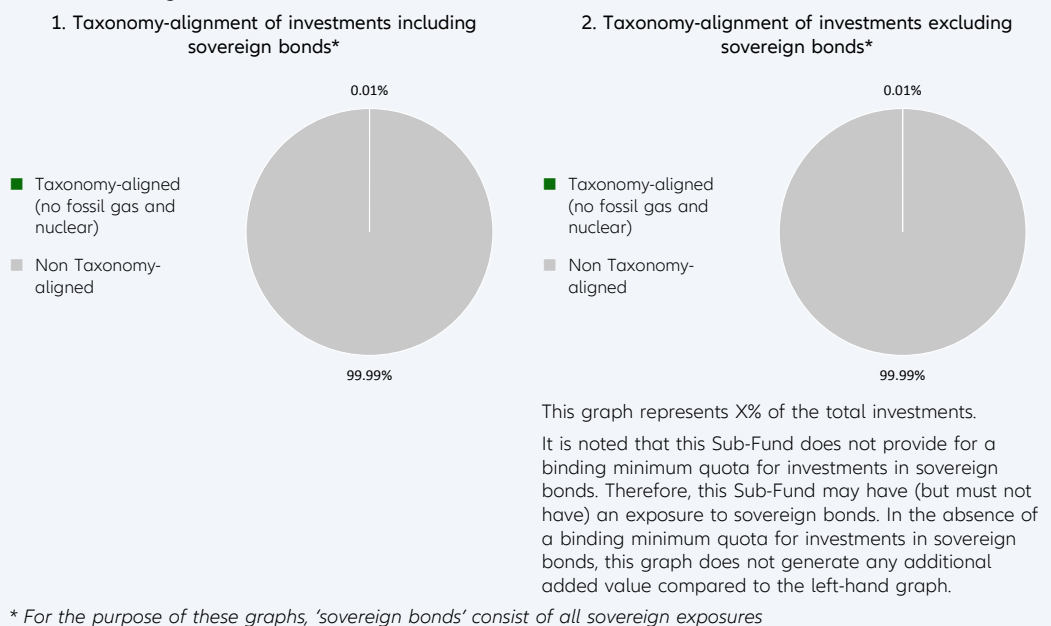

Enabling activities directly enable other activities to make a substantial contribution to an environmental objective.

● **What is the minimum share of investments in transitional and enabling activities?**

The Sub-Fund's Investment Manager does not commit to a split of minimum taxonomy alignment into transitional, enabling activities and own performance.

Transitional activities are activities for which low-carbon alternatives are not yet available and among others have greenhouse gas emission levels corresponding to the best performance.



What is the minimum share of sustainable investments with an environmental objective that are not aligned with the EU Taxonomy?

Taxonomy-aligned investments are considered a sub-category of Sustainable Investments. If an investment is not Taxonomy-aligned since the activity is not yet covered under the EU Taxonomy or the positive contribution is not substantial enough to comply with the Taxonomy technical screening criteria, the investment can still be considered an environmentally Sustainable Investment provided it complies with all criteria. The Investment Manager does not commit to a minimum share of environmentally Sustainable Investments that are not aligned with the EU Taxonomy. The overall sustainable investment share may also include investments with an environmental objective in economic activities that do not qualify as environmentally sustainable under the EU Taxonomy, and while the Sub-Fund cannot commit to a minimum share of environmentally or socially sustainable investments, such investments may be freely allocated to within the Sub-Fund aggregated sustainable investment commitment disclosed (min. 30%).

are sustainable investments with an environmental objective that **do not take into account the criteria** for environmentally sustainable economic activities under the EU Taxonomy.



What is the minimum share of socially sustainable investments?

The Investment Manager defines Sustainable Investments based on internal research, which uses, among others, the UN Sustainable Development Goals (SDGs), as well as the objectives of the EU Taxonomy as reference frameworks. The Investment Manager does not commit to a minimum share of socially Sustainable Investments, as the SDGs contain environmental as well as social objectives. The overall sustainable investment share may also include investments with a social objective, and while the Sub-Fund cannot commit to a minimum share of environmentally or socially sustainable investments, such investments may be freely allocated to within the Sub-Fund aggregated sustainable investment commitment disclosed (min. 30%).



What investments are included under “#2 Other”, what is their purpose and are there any minimum environmental or social safeguards?

Under #2 Other investments into cash, Target Funds, or derivatives can be included. Derivatives might be used for efficient portfolio management (including risk hedging) and/or investment purposes, and Target Funds to benefit from a specific strategy. For those investments no environmental or social safeguards are applied.



Is a specific index designated as a reference benchmark to determine whether this financial product is aligned with the environmental and/or social characteristics that it promotes?

No reference benchmark has been designated for the purpose of attaining the environmental and/or social characteristics promoted by the Sub-Fund

- How is the reference benchmark continuously aligned with each of the environmental or social characteristics promoted by the financial product?

Not applicable

- How is the alignment of the investment strategy with the methodology of the index ensured on a continuous basis?

Not applicable

- How does the designated index differ from a relevant broad market index?

Not applicable

- Where can the methodology used for the calculation of the designated index be found?

Not applicable

Reference benchmarks are indexes to measure whether the financial product attains the environmental or social characteristics that they promote.



Where can I find more product specific information online?

More product-specific information can be found on the website: <https://regulatory.allianzgi.com/SFDR>

Template pre-contractual disclosure for the financial products referred to in Article 8, paragraphs 1, 2 and 2a, of Regulation (EU) 2019/2088 and Article 6, first paragraph, of Regulation (EU) 2020/852

Product name:

Allianz Strategy4Life 30

Legal entity identifier: New Product - Not Identified

Environmental and/or social characteristics

Sustainable investment means an investment in an economic activity that contributes to an environmental or social objective, provided that the investment does not significantly harm any environmental or social objective and that the investee companies follow good governance practices.

The **EU Taxonomy** is a classification system laid down in Regulation (EU) 2020/852, establishing a list of **environmentally sustainable economic activities**. That Regulation does not include a list of socially sustainable economic activities. Sustainable investments with an environmental objective might be aligned with the Taxonomy or not.

Does this financial product have a sustainable investment objective?	
<input checked="" type="radio"/> <input checked="" type="radio"/> Yes	<input checked="" type="radio"/> <input type="radio"/> No
<input type="checkbox"/> It will make a minimum of sustainable investments with an environmental objective : ___% <ul style="list-style-type: none"> <input type="checkbox"/> in economic activities that qualify as environmentally sustainable under the EU Taxonomy <input type="checkbox"/> in economic activities that do not qualify as environmentally sustainable under the EU Taxonomy 	<input type="checkbox"/> It promotes Environmental/Social (E/S) characteristics and while it does not have as its objective a sustainable investment, it will have a minimum proportion of ___% of sustainable investments <ul style="list-style-type: none"> <input type="checkbox"/> with an environmental objective in economic activities that qualify as environmentally sustainable under the EU Taxonomy <input type="checkbox"/> with an environmental objective in economic activities that do not qualify as environmentally sustainable under the EU Taxonomy <input type="checkbox"/> with a social objective
<input type="checkbox"/> It will make a minimum of sustainable investments with a social objective ___%	<input checked="" type="checkbox"/> It promotes E/S characteristics, but will not make any sustainable investments



What environmental and/or social characteristics are promoted by this financial product?

Allianz Strategy4Life 30 (the "Sub-Fund") promotes environmental, social, human rights, governance, and business behaviour factors (this domain does not apply for sovereigns issued by a Sovereign Entity) through integration of a best-in-class approach into the Sub-Fund's investment process. This encompasses the evaluation of corporate or sovereign issuers based on an SRI Rating which is used to construct the portfolio.

In addition, sustainable minimum exclusion criteria apply.

No reference benchmark has been designated for the purpose of attaining the environmental and/or social characteristics promoted by the Sub-Fund.

● What sustainability indicators are used to measure the attainment of each of the environmental or social characteristics promoted by this financial product?

To measure the attainment of the environmental and/or social characteristics the following sustainability indicators are used and reported on, at the fiscal year end:

- The actual percentage of the Sub-Fund's Portfolio (Portfolio in this respect does not comprise non-rated derivatives and instruments that are non-rated by nature (e. g., cash and deposits)) assets invested in best-in-class issuers (issuers with a minimum SRI Rating of 2 out of a scale from 0-4; 0 being the worst rating and 4 the best rating).
- Confirmation that Principal Adverse Impacts (PAIs) of investment decisions on sustainability factors are considered through the application of exclusion criteria.

Sustainability indicators measure how the environmental or social characteristics promoted by the financial product are attained.

- What are the objectives of the sustainable investments that the financial product partially intends to make and how does the sustainable investment contribute to such objectives?

Not applicable

- How do the sustainable investments that the financial product partially intends to make, not cause significant harm to any environmental or social sustainable investment objective?

Not applicable

- How have the indicators for adverse impacts on sustainability factors been taken into account?

Not applicable

- How are the sustainable investments aligned with the OECD Guidelines for Multinational Enterprises and the UN Guiding Principles on Business and Human Rights? Details:

Not applicable

Principal adverse impacts are the most significant negative impacts of investment decisions on sustainability factors relating to environmental, social and employee matters, respect for human rights, anti-corruption and anti-bribery matters.



Does this financial product consider principal adverse impacts on sustainability factors?

Yes

No

The Management Company has joined the Net Zero Asset Manager Initiative and considers PAI indicators through stewardship including engagement, both are relevant to mitigate potential adverse impact as a company.

Due to the commitment to the Net Zero Asset Manager Initiative, the Management Company aims to reduce greenhouse gas emissions in partnership with asset owner clients on decarbonisation goals, consistent with an ambition to reach net zero emission by 2050 or sooner across all assets under management. As part of this objective the Management Company will set an interim target for the proportion of assets to be managed in line with the attainment of net zero emissions by 2050 or sooner.

The Sub-Fund's Investment Manager considers PAI indicators regarding greenhouse gas emission, biodiversity, water, waste as well as social and employee matters for corporate issuers, and, where relevant, the freedom house index is applied to investments in sovereigns. PAI indicators are considered within the Investment Manager's investment process through the means of exclusions as described in the "binding elements" section of the Sub-Fund.

The data coverage for the data required for the PAI indicators is heterogenous. The data coverage related to biodiversity, water and waste is low and the related PAI indicators are considered through exclusion of securities issued by companies having a severe violation / breach of principles and guidelines such as the Principles of the United Nations Global Compact, the OECD Guidelines for Multinational Enterprises, and the United Nations Guiding Principles for Business and Human Rights on the grounds of problematic practices around human rights, labour rights, environment, and corruption issues. Therefore, the Investment Manager will strive to increase data coverage for PAI indicators with low data coverage. The Investment Manager will regularly evaluate whether the availability of data has increased sufficiently to potentially include assessment of such data in the investment process.

Additionally, PAI indicators are, among other sustainability factors, applied to derive the SRI Rating. The SRI Rating is used for the portfolio construction.

The following PAI indicators are considered:

Applicable to corporate issuers

- GHG Emissions

- Carbon footprint
- GHG Intensity of investee companies
- Exposure to companies active in the fossil fuel sector
- Activities negatively affecting biodiversity-sensitive areas
- Emissions to water
- Hazardous waste ratio
- Violation of UN Global compact principles
- Lack of processes and compliance mechanisms to monitor compliance with UN Global Compact principles
- Board gender diversity
- Exposure to controversial weapons

Applicable to sovereign and supranational issuers

- Investee countries subject to social violations

The information on the PAI indicators will be available in the end-year report of the Sub-Fund.



What investment strategy does this financial product follow?

The investment strategy guides investment decisions based on factors such as investment objectives and risk tolerance.

Allianz Strategy4Life 30's investment objective is to invest in global Equity, European Bond and Money Markets in order to achieve over the medium-term a performance comparable to a balanced portfolio within a volatility range of 2% - 8%. The assessment of the volatility of the capital markets by the Investment Manager is an important factor in this process, with the aim of typically not falling below or exceeding a volatility of the Share price within a range of 2% - 8% on a medium to long-term average, similar to a portfolio consisting of 30% global Equity Markets and 70% medium-term Euro Bond Markets in accordance with the Sustainable and Responsible Investment Strategy (SRI Strategy). In times of high volatility/ low volatility the equity market-oriented portion will be reduced/ will be increased.

As part of the SRI best-in-class approach, the Sub-Fund takes environmental, social, human rights, governance, and business behaviour factors into account as follows:

- The aforesaid sustainability factors are analysed through SRI Research by the Investment Manager in order to assess how sustainable development and long-term issues are taken into account in the strategy of an issuer. SRI Research means the overall process of identifying potential risks as well as potential opportunities of an investment in securities of an issuer related to the analysis of sustainability factors. SRI Research data combines external research data (which might have some limitations) with internal analyses.
- Based on a combination of the results of the external and/or internal analyses of the sustainability factors, an internal rating is derived monthly (SRI Rating) and is afterwards assigned to a corporate or sovereign issuer.

This internal SRI Rating is used to rank and select or weight securities for the portfolio construction.

The Sub-Fund's general investment approach (Sub-Fund's applicable General Asset Class Principles in combination with its individual investment restrictions) is described in the prospectus.

● What are the binding elements of the investment strategy used to select the investments to attain each of the environmental or social characteristics promoted by this financial product?

The binding elements are:

- Minimum rating coverage: At least 90% of the Sub-Fund's portfolio is required to have an SRI Rating (portfolio in this respect does not comprise non-rated derivatives and instruments that are non-rated by nature e.g., cash and deposits). While most holdings of the Sub-Fund will have a corresponding SRI Rating some investments cannot be rated according to the SRI Research methodology. Examples of instruments not attaining to the SRI Rating include, but are not limited to cash, deposits, Target Funds, and non-rated investments.
- The rated instruments are adhering to the minimum rating threshold of 2 (out of a rating scale from 0 – 4; 0 being the worst rating and 4 the best rating).

- Application of the following sustainable minimum exclusion criteria for direct investments:
- securities issued by companies having a severe violation / breach of principles and guidelines such as the Principles of the United Nations Global Compact, the OECD Guidelines for Multinational Enterprises, and the United Nations Guiding Principles for Business and Human Rights on the grounds of problematic practices around human rights, labour rights, environment, and corruption issues,
- securities issued by companies involved in controversial weapons (anti-personnel mines, cluster munitions, chemical weapons, biological weapons, depleted uranium, white phosphorus, and nuclear weapons),
- securities issued by companies that derive more than 10% of their revenues from weapons, military equipment, and services,
- securities issued by companies that derive more than 10% of their revenue from thermal coal extraction,
- securities issued by utility companies that generate more than 20% of their revenues from coal,
- securities issued by companies involved in the production of tobacco, and securities issued by companies involved in the distribution of tobacco with more than 5% of their revenues.

Direct investments in sovereign issuers with an insufficient freedom house index score are excluded.

The sustainable minimum exclusion criteria are based on information from an external data provider and coded in pre- and post-trade compliance. The review is performed at least half yearly.

● **What is the committed minimum rate to reduce the scope of the investments considered prior to the application of that investment strategy?**

The Sub-Fund does not commit to reduce the scope of the investments by a certain minimum rate.

● **What is the policy to assess good governance practices of the investee companies?**

Good governance principles are considered by screening out companies based on their involvement in controversies around international norms corresponding to the four good governance practices: sound management structures, employee relations, remuneration of staff and tax compliance. Companies having a severe violation in either of those areas will not be investible. For certain cases, flagged issuers shall be on a watch list. These companies will appear on this watch list when the Investment Manager believes that engagement may lead to improvements or when the company is assessed to take remedial actions. Companies on the watch list remain investible unless the Investment Manager believes that the engagement or the remedial actions of the company does not lead to the desired remedy of the severe controversy.

In addition, the Sub-Fund's Investment Manager is committed to actively encourage open dialogues with investee companies on corporate governance, proxy voting and broader sustainability issues in advance of shareholder meetings (regularly for direct investments in shares). The Sub-Fund's Investment Manager's approach to proxy voting and company engagement is set out in the Management Company's Stewardship Statement.

Good governance practices include sound management structures, employee relations, remuneration of staff and tax compliance.



What is the asset allocation planned for this financial product?

Asset allocation describes the share of investments in specific assets.

Min. 90% of the Sub-Funds' assets (excluding cash and non-rated derivatives) are used to meet the environmental or social characteristics promoted by this Sub-Fund. A low portion of the Sub-Fund might contain assets which do not promote environmental or social characteristics. Examples of such instruments are derivatives, cash and deposits, some Target Funds and investment with temporarily divergent or absent environmental, social, or good governance qualifications.

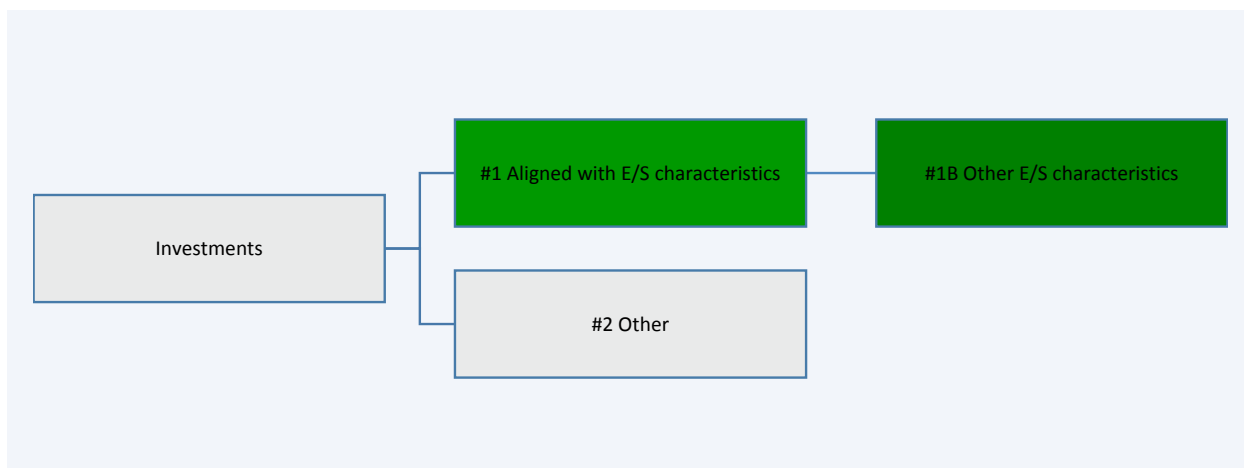

#1 Aligned with E/S characteristics includes the investments of the financial product used to attain the environmental or social characteristics promoted by the financial product.

#2 Other includes the remaining investments of the financial product which are neither aligned with the environmental or social characteristics, nor are qualified as sustainable investments.

The category **#1 Aligned with E/S characteristics** covers:

- The sub-category **#1A Sustainable** covers sustainable investments with environmental or social objectives.
- The sub-category **#1B Other E/S characteristics** covers investments aligned with the environmental or social characteristics that do not qualify as sustainable investments.

- **How does the use of derivatives attain the environmental or social characteristics promoted by the financial product?**

Not applicable



To what minimum extent are sustainable investments with an environmental objective aligned with the EU Taxonomy?

The Sub-Fund's Investment Manager does not commit to a minimum share of sustainable investments with an environmental objective aligned with the EU Taxonomy.

- **Does the financial product invest in fossil gas and/or nuclear energy related activities that comply with the EU Taxonomy¹?**

- Yes:
 - In fossil gas
 - In nuclear energy
- No

Taxonomy-aligned activities are expressed as a share of:

- **turnover** reflecting the share of revenue from green activities of investee companies
- **capital expenditure** (CapEx) showing the green investments made by investee companies, e.g. for a transition to a green economy.
- **operational expenditure** (OpEx) reflecting green operational activities of investee companies.

¹ Fossil gas and/or nuclear related activities will only comply with the EU Taxonomy where they contribute to limiting climate change ("climate change mitigation") and do not significantly harm any EU Taxonomy objective - see explanatory note in the left hand margin. The full criteria for fossil gas and nuclear energy economic activities that comply with the EU Taxonomy are laid down in Commission Delegated Regulation (EU) 2022/1214.

The two graphs below show in green the minimum percentage of investments that are aligned with the EU Taxonomy. As there is no appropriate methodology to determine the Taxonomy-alignment of sovereign bonds*, the first graph shows the Taxonomy-alignment in relation to all the investments of the financial product including sovereign bonds, while the second graph shows the Taxonomy-alignment only in relation to the investments of the financial product other than sovereign bonds.

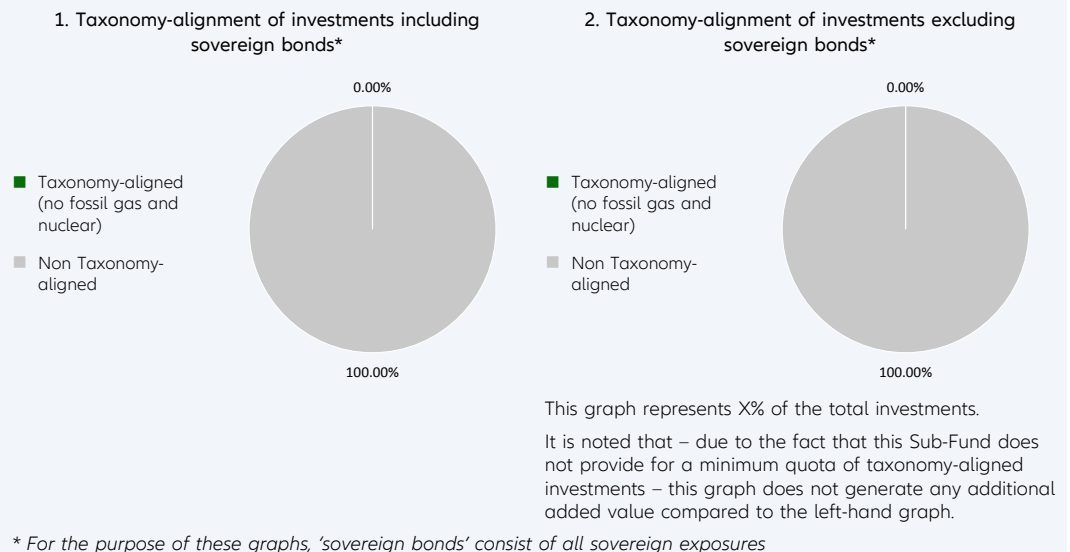

Enabling activities directly enable other activities to make a substantial contribution to an environmental objective.

Transitional activities are activities for which low-carbon alternatives are not yet available and among others have greenhouse gas emission levels corresponding to the best performance.

● **What is the minimum share of investments in transitional and enabling activities?**

The Sub-Fund’s Investment Manager does not commit to a split of minimum taxonomy alignment into transitional, enabling activities and own performance.



What is the minimum share of sustainable investments with an environmental objective that are not aligned with the EU Taxonomy?

The Sub-Fund’s Investment Manager does not commit to a minimum share of investments with an environmental objective that are not aligned with the EU Taxonomy.

 are sustainable investments with an environmental objective that **do not take into account the criteria** for environmentally sustainable economic activities under the EU Taxonomy.



What is the minimum share of socially sustainable investments?

The Sub-Fund’s Investment Manager does not commit to a minimum share of socially sustainable investments.



What investments are included under “#2 Other”, what is their purpose and are there any minimum environmental or social safeguards?

Under “#2 Other” investments into cash, Target Funds, or derivatives can be included. Derivatives might be used for efficient portfolio management (including risk hedging) and/or investment purposes, and Target Funds to benefit from a specific strategy. For those investments no environmental or social safeguards are applied.



Is a specific index designated as a reference benchmark to determine whether this financial product is aligned with the environmental and/or social characteristics that it promotes?

No reference benchmark has been designated for the purpose of attaining the environmental and/or social characteristics promoted by the Sub-Fund.

Reference benchmarks are indexes to measure whether the financial product attains the environmental or social characteristics that they promote.

- How is the reference benchmark continuously aligned with each of the environmental or social characteristics promoted by the financial product?
Not applicable
- How is the alignment of the investment strategy with the methodology of the index ensured on a continuous basis?
Not applicable
- How does the designated index differ from a relevant broad market index?
Not applicable
- Where can the methodology used for the calculation of the designated index be found?
Not applicable



Where can I find more product specific information online?

More product-specific information can be found on the website: <https://regulatory.allianzgi.com/SFDR>

Template pre-contractual disclosure for the financial products referred to in Article 8, paragraphs 1, 2 and 2a, of Regulation (EU) 2019/2088 and Article 6, first paragraph, of Regulation (EU) 2020/852

Product name:

Allianz Strategy4Life 50

Legal entity identifier: New Product - Not Identified

Environmental and/or social characteristics

Sustainable investment means an investment in an economic activity that contributes to an environmental or social objective, provided that the investment does not significantly harm any environmental or social objective and that the investee companies follow good governance practices.

The **EU Taxonomy** is a classification system laid down in Regulation (EU) 2020/852, establishing a list of **environmentally sustainable economic activities**. That Regulation does not include a list of socially sustainable economic activities. Sustainable investments with an environmental objective might be aligned with the Taxonomy or not.

Does this financial product have a sustainable investment objective?

Yes

No

It will make a minimum of **sustainable investments with an environmental objective**: ___%

in economic activities that qualify as environmentally sustainable under the EU Taxonomy

in economic activities that do not qualify as environmentally sustainable under the EU Taxonomy

It will make a minimum of **sustainable investments with a social objective** ___%

It **promotes Environmental/Social (E/S) characteristics** and while it does not have as its objective a sustainable investment, it will have a minimum proportion of ___% of sustainable investments

with an environmental objective in economic activities that qualify as environmentally sustainable under the EU Taxonomy

with an environmental objective in economic activities that do not qualify as environmentally sustainable under the EU Taxonomy

with a social objective

It promotes E/S characteristics, but **will not make any sustainable investments**



What environmental and/or social characteristics are promoted by this financial product?

Allianz Strategy4Life 50 (the "Sub-Fund") promotes environmental, social, human rights, governance, and business behaviour factors (this domain does not apply for sovereigns issued by a Sovereign Entity) through integration of a best-in-class approach into the Sub-Fund's investment process. This encompasses the evaluation of corporate or sovereign issuers based on an SRI Rating which is used to construct the portfolio.

In addition, sustainable minimum exclusion criteria apply.

No reference benchmark has been designated for the purpose of attaining the environmental and/or social characteristics promoted by the Sub-Fund.

● What sustainability indicators are used to measure the attainment of each of the environmental or social characteristics promoted by this financial product?

To measure the attainment of the environmental and/or social characteristics the following sustainability indicators are used and reported on, at the fiscal year end:

- The actual percentage of the Sub-Fund's Portfolio (Portfolio in this respect does not comprise non-rated derivatives and instruments that are non-rated by nature (e. g., cash and deposits)) assets invested in best-in-class issuers (issuers with a minimum SRI Rating of 2 out of a scale from 0-4; 0 being the worst rating and 4 the best rating).
- Confirmation that Principal Adverse Impacts (PAIs) of investment decisions on sustainability factors are considered through the application of exclusion criteria.

Sustainability indicators measure how the environmental or social characteristics promoted by the financial product are attained.

- What are the objectives of the sustainable investments that the financial product partially intends to make and how does the sustainable investment contribute to such objectives?

Not applicable

- How do the sustainable investments that the financial product partially intends to make, not cause significant harm to any environmental or social sustainable investment objective?

Not applicable

- How have the indicators for adverse impacts on sustainability factors been taken into account?

Not applicable

- How are the sustainable investments aligned with the OECD Guidelines for Multinational Enterprises and the UN Guiding Principles on Business and Human Rights? Details:

Not applicable

Principal adverse impacts are the most significant negative impacts of investment decisions on sustainability factors relating to environmental, social and employee matters, respect for human rights, anti-corruption and anti-bribery matters.



Does this financial product consider principal adverse impacts on sustainability factors?

Yes

No

The Management Company has joined the Net Zero Asset Manager Initiative and considers PAI indicators through stewardship including engagement, both are relevant to mitigate potential adverse impact as a company.

Due to the commitment to the Net Zero Asset Manager Initiative, the Management Company aims to reduce greenhouse gas emissions in partnership with asset owner clients on decarbonisation goals, consistent with an ambition to reach net zero emission by 2050 or sooner across all assets under management. As part of this objective the Management Company will set an interim target for the proportion of assets to be managed in line with the attainment of net zero emissions by 2050 or sooner.

The Sub-Fund's Investment Manager considers PAI indicators regarding greenhouse gas emission, biodiversity, water, waste as well as social and employee matters for corporate issuers, and, where relevant, the freedom house index is applied to investments in sovereigns. PAI indicators are considered within the Investment Manager's investment process through the means of exclusions as described in the "binding elements" section of the Sub-Fund.

The data coverage for the data required for the PAI indicators is heterogenous. The data coverage related to biodiversity, water and waste is low and the related PAI indicators are considered through exclusion of securities issued by companies having a severe violation / breach of principles and guidelines such as the Principles of the United Nations Global Compact, the OECD Guidelines for Multinational Enterprises, and the United Nations Guiding Principles for Business and Human Rights on the grounds of problematic practices around human rights, labour rights, environment, and corruption issues. Therefore, the Investment Manager will strive to increase data coverage for PAI indicators with low data coverage. The Investment Manager will regularly evaluate whether the availability of data has increased sufficiently to potentially include assessment of such data in the investment process.

Additionally, PAI indicators are, among other sustainability factors, applied to derive the SRI Rating. The SRI Rating is used for the portfolio construction.

The following PAI indicators are considered:

Applicable to corporate issuers

- GHG Emissions

- Carbon footprint
- GHG Intensity of investee companies
- Exposure to companies active in the fossil fuel sector
- Activities negatively affecting biodiversity-sensitive areas
- Emissions to water
- Hazardous waste ratio
- Violation of UN Global compact principles
- Lack of processes and compliance mechanisms to monitor compliance with UN Global Compact principles
- Board gender diversity
- Exposure to controversial weapons

Applicable to sovereign and supranational issuers

- Investee countries subject to social violations

The information on the PAI indicators will be available in the end-year report of the Sub-Fund.



What investment strategy does this financial product follow?

The investment strategy guides investment decisions based on factors such as investment objectives and risk tolerance.

Allianz Strategy4Life 50's investment objective is to invest in global Equity, European Bond and Money Markets in order to achieve over the medium-term a performance comparable to a balanced portfolio within a volatility range of 5% - 11%. The assessment of the volatility of the capital markets by the Investment Manager is an important factor in this process, with the aim of typically not falling below or exceeding a volatility of the Share price within a range of 5% - 11% on a medium to long-term average, similar to a portfolio consisting of 50% global Equity Markets and 50% medium-term Euro Bond Markets in accordance with the Sustainable and Responsible Investment Strategy (SRI Strategy). In times of high volatility/ low volatility the equity market-oriented portion will be reduced/ will be increased.

As part of the SRI best-in-class approach, the Sub-Fund takes environmental, social, human rights, governance, and business behaviour factors into account as follows:

- The aforesaid sustainability factors are analysed through SRI Research by the Investment Manager in order to assess how sustainable development and long-term issues are taken into account in the strategy of an issuer. SRI Research means the overall process of identifying potential risks as well as potential opportunities of an investment in securities of an issuer related to the analysis of sustainability factors. SRI Research data combines external research data (which might have some limitations) with internal analyses.
- Based on a combination of the results of the external and/or internal analyses of the sustainability factors, an internal rating is derived monthly (SRI Rating) and is afterwards assigned to a corporate or sovereign issuer.

This internal SRI Rating is used to rank and select or weight securities for the portfolio construction.

The Sub-Fund's general investment approach (Sub-Fund's applicable General Asset Class Principles in combination with its individual investment restrictions) is described in the prospectus.

● What are the binding elements of the investment strategy used to select the investments to attain each of the environmental or social characteristics promoted by this financial product?

The binding elements are:

- Minimum rating coverage: At least 90% of the Sub-Fund's portfolio is required to have an SRI Rating (portfolio in this respect does not comprise non-rated derivatives and instruments that are non-rated by nature e.g., cash and deposits). While most holdings of the Sub-Fund will have a corresponding SRI Rating some investments cannot be rated according to the SRI Research methodology. Examples of instruments not attaining to the SRI Rating include, but are not limited to cash, deposits, Target Funds, and non-rated investments.
- The rated instruments are adhering to the minimum rating threshold of 2 (out of a rating scale from 0 – 4; 0 being the worst rating and 4 the best rating).

- Application of the following sustainable minimum exclusion criteria for direct investments:
- securities issued by companies having a severe violation / breach of principles and guidelines such as the Principles of the United Nations Global Compact, the OECD Guidelines for Multinational Enterprises, and the United Nations Guiding Principles for Business and Human Rights on the grounds of problematic practices around human rights, labour rights, environment, and corruption issues,
- securities issued by companies involved in controversial weapons (anti-personnel mines, cluster munitions, chemical weapons, biological weapons, depleted uranium, white phosphorus, and nuclear weapons),
- securities issued by companies that derive more than 10% of their revenues from weapons, military equipment, and services,
- securities issued by companies that derive more than 10% of their revenue from thermal coal extraction,
- securities issued by utility companies that generate more than 20% of their revenues from coal,
- securities issued by companies involved in the production of tobacco, and securities issued by companies involved in the distribution of tobacco with more than 5% of their revenues.

Direct investments in sovereign issuers with an insufficient freedom house index score are excluded.

The sustainable minimum exclusion criteria are based on information from an external data provider and coded in pre- and post-trade compliance. The review is performed at least half yearly.

● **What is the committed minimum rate to reduce the scope of the investments considered prior to the application of that investment strategy?**

The Sub-Fund does not commit to reduce the scope of the investments by a certain minimum rate.

● **What is the policy to assess good governance practices of the investee companies?**

Good governance principles are considered by screening out companies based on their involvement in controversies around international norms corresponding to the four good governance practices: sound management structures, employee relations, remuneration of staff and tax compliance. Companies having a severe violation in either of those areas will not be investible. For certain cases, flagged issuers shall be on a watch list. These companies will appear on this watch list when the Investment Manager believes that engagement may lead to improvements or when the company is assessed to take remedial actions. Companies on the watch list remain investible unless the Investment Manager believes that the engagement or the remedial actions of the company does not lead to the desired remedy of the severe controversy.

In addition, the Sub-Fund's Investment Manager is committed to actively encourage open dialogues with investee companies on corporate governance, proxy voting and broader sustainability issues in advance of shareholder meetings (regularly for direct investments in shares). The Sub-Fund's Investment Manager's approach to proxy voting and company engagement is set out in the Management Company's Stewardship Statement.

Good governance practices include sound management structures, employee relations, remuneration of staff and tax compliance.



What is the asset allocation planned for this financial product?

Asset allocation describes the share of investments in specific assets.

Min. 90% of the Sub-Funds' assets (excluding cash and non-rated derivatives) are used to meet the environmental or social characteristics promoted by this Sub-Fund. A low portion of the Sub-Fund might contain assets which do not promote environmental or social characteristics. Examples of such instruments are derivatives, cash and deposits, some Target Funds and investment with temporarily divergent or absent environmental, social, or good governance qualifications.

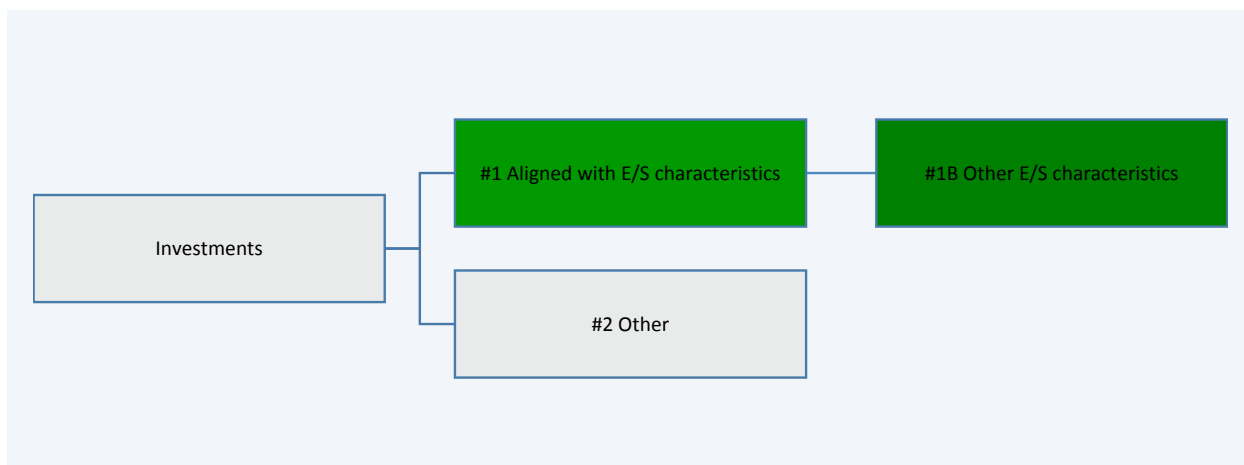

#1 Aligned with E/S characteristics includes the investments of the financial product used to attain the environmental or social characteristics promoted by the financial product.

#2 Other includes the remaining investments of the financial product which are neither aligned with the environmental or social characteristics, nor are qualified as sustainable investments.

The category **#1 Aligned with E/S characteristics** covers:

- The sub-category **#1A Sustainable** covers sustainable investments with environmental or social objectives.
- The sub-category **#1B Other E/S characteristics** covers investments aligned with the environmental or social characteristics that do not qualify as sustainable investments.

- **How does the use of derivatives attain the environmental or social characteristics promoted by the financial product?**

Not applicable



To what minimum extent are sustainable investments with an environmental objective aligned with the EU Taxonomy?

The Sub-Fund's Investment Manager does not commit to a minimum share of sustainable investments with an environmental objective aligned with the EU Taxonomy.

- **Does the financial product invest in fossil gas and/or nuclear energy related activities that comply with the EU Taxonomy¹?**

Yes:

In fossil gas In nuclear energy

No

Taxonomy-aligned activities are expressed as a share of:

- **turnover** reflecting the share of revenue from green activities of investee companies
- **capital expenditure** (CapEx) showing the green investments made by investee companies, e.g. for a transition to a green economy.
- **operational expenditure** (OpEx) reflecting green operational activities of investee companies.

¹ Fossil gas and/or nuclear related activities will only comply with the EU Taxonomy where they contribute to limiting climate change ("climate change mitigation") and do not significantly harm any EU Taxonomy objective - see explanatory note in the left hand margin. The full criteria for fossil gas and nuclear energy economic activities that comply with the EU Taxonomy are laid down in Commission Delegated Regulation (EU) 2022/1214.

The two graphs below show in green the minimum percentage of investments that are aligned with the EU Taxonomy. As there is no appropriate methodology to determine the Taxonomy-alignment of sovereign bonds*, the first graph shows the Taxonomy-alignment in relation to all the investments of the financial product including sovereign bonds, while the second graph shows the Taxonomy-alignment only in relation to the investments of the financial product other than sovereign bonds.

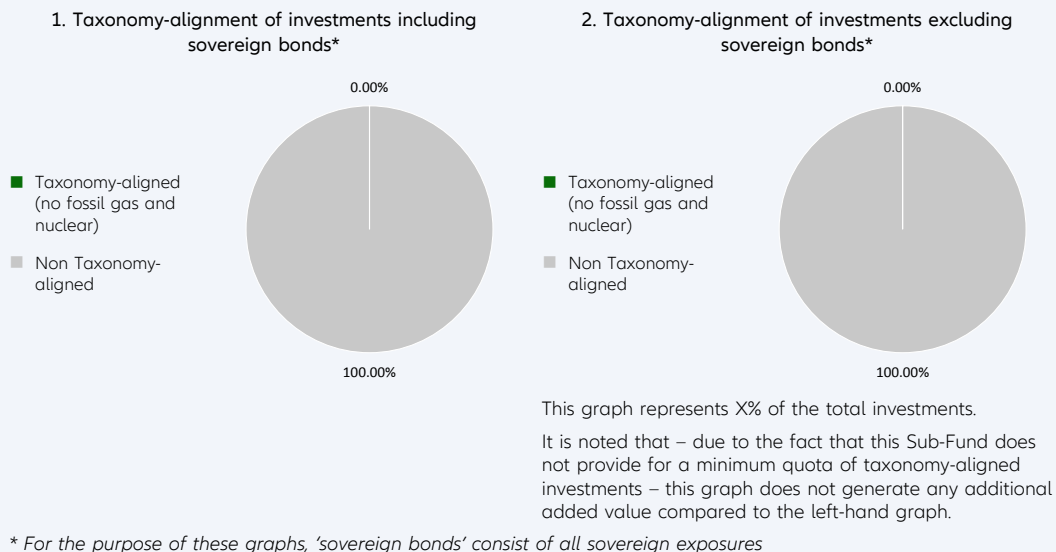

Enabling activities directly enable other activities to make a substantial contribution to an environmental objective.

Transitional activities are activities for which low-carbon alternatives are not yet available and among others have greenhouse gas emission levels corresponding to the best performance.

● **What is the minimum share of investments in transitional and enabling activities?**

The Sub-Fund’s Investment Manager does not commit to a split of minimum taxonomy alignment into transitional, enabling activities and own performance.



What is the minimum share of sustainable investments with an environmental objective that are not aligned with the EU Taxonomy?

The Sub-Fund’s Investment Manager does not commit to a minimum share of investments with an environmental objective that are not aligned with the EU Taxonomy.



are sustainable investments with an environmental objective that **do not take into account the criteria** for environmentally sustainable economic activities under the EU Taxonomy.



What is the minimum share of socially sustainable investments?

The Sub-Fund’s Investment Manager does not commit to a minimum share of socially sustainable investments.



What investments are included under “#2 Other”, what is their purpose and are there any minimum environmental or social safeguards?

Under “#2 Other” investments into cash, Target Funds, or derivatives can be included. Derivatives might be used for efficient portfolio management (including risk hedging) and/or investment purposes, and Target Funds to benefit from a specific strategy. For those investments no environmental or social safeguards are applied.



Is a specific index designated as a reference benchmark to determine whether this financial product is aligned with the environmental and/or social characteristics that it promotes?

No reference benchmark has been designated for the purpose of attaining the environmental and/or social characteristics promoted by the Sub-Fund.

Reference benchmarks are indexes to measure whether the financial product attains the environmental or social characteristics that they promote.

- How is the reference benchmark continuously aligned with each of the environmental or social characteristics promoted by the financial product?
Not applicable
- How is the alignment of the investment strategy with the methodology of the index ensured on a continuous basis?
Not applicable
- How does the designated index differ from a relevant broad market index?
Not applicable
- Where can the methodology used for the calculation of the designated index be found?
Not applicable



Where can I find more product specific information online?

More product-specific information can be found on the website: <https://regulatory.allianzgi.com/SFDR>

Template pre-contractual disclosure for the financial products referred to in Article 8, paragraphs 1, 2 and 2a, of Regulation (EU) 2019/2088 and Article 6, first paragraph, of Regulation (EU) 2020/852

Product name:

Allianz Strategy4Life 75

Legal entity identifier: New Product - Not Identified

Environmental and/or social characteristics

Sustainable investment means an investment in an economic activity that contributes to an environmental or social objective, provided that the investment does not significantly harm any environmental or social objective and that the investee companies follow good governance practices.

The **EU Taxonomy** is a classification system laid down in Regulation (EU) 2020/852, establishing a list of **environmentally sustainable economic activities**. That Regulation does not include a list of socially sustainable economic activities. Sustainable investments with an environmental objective might be aligned with the Taxonomy or not.

Does this financial product have a sustainable investment objective?	
<input checked="" type="radio"/> <input checked="" type="radio"/> Yes	<input checked="" type="radio"/> <input type="radio"/> No
<input type="checkbox"/> It will make a minimum of sustainable investments with an environmental objective : ___% <ul style="list-style-type: none"> <input type="checkbox"/> in economic activities that qualify as environmentally sustainable under the EU Taxonomy <input type="checkbox"/> in economic activities that do not qualify as environmentally sustainable under the EU Taxonomy 	<input type="checkbox"/> It promotes Environmental/Social (E/S) characteristics and while it does not have as its objective a sustainable investment, it will have a minimum proportion of ___% of sustainable investments <ul style="list-style-type: none"> <input type="checkbox"/> with an environmental objective in economic activities that qualify as environmentally sustainable under the EU Taxonomy <input type="checkbox"/> with an environmental objective in economic activities that do not qualify as environmentally sustainable under the EU Taxonomy <input type="checkbox"/> with a social objective
<input type="checkbox"/> It will make a minimum of sustainable investments with a social objective ___%	<input checked="" type="checkbox"/> It promotes E/S characteristics, but will not make any sustainable investments



What environmental and/or social characteristics are promoted by this financial product?

Allianz Strategy4Life 75 (the "Sub-Fund") promotes environmental, social, human rights, governance, and business behaviour factors (this domain does not apply for sovereigns issued by a Sovereign Entity) through integration of a best-in-class approach into the Sub-Fund's investment process. This encompasses the evaluation of corporate or sovereign issuers based on an SRI Rating which is used to construct the portfolio.

In addition, sustainable minimum exclusion criteria apply.

No reference benchmark has been designated for the purpose of attaining the environmental and/or social characteristics promoted by the Sub-Fund.

● What sustainability indicators are used to measure the attainment of each of the environmental or social characteristics promoted by this financial product?

To measure the attainment of the environmental and/or social characteristics the following sustainability indicators are used and reported on, at the fiscal year end:

- The actual percentage of the Sub-Fund's Portfolio (Portfolio in this respect does not comprise non-rated derivatives and instruments that are non-rated by nature (e. g., cash and deposits)) assets invested in best-in-class issuers (issuers with a minimum SRI Rating of 2 out of a scale from 0-4; 0 being the worst rating and 4 the best rating).
- Confirmation that Principal Adverse Impacts (PAIs) of investment decisions on sustainability factors are considered through the application of exclusion criteria.

Sustainability indicators measure how the environmental or social characteristics promoted by the financial product are attained.

- What are the objectives of the sustainable investments that the financial product partially intends to make and how does the sustainable investment contribute to such objectives?

Not applicable

- How do the sustainable investments that the financial product partially intends to make, not cause significant harm to any environmental or social sustainable investment objective?

Not applicable

- How have the indicators for adverse impacts on sustainability factors been taken into account?

Not applicable

- How are the sustainable investments aligned with the OECD Guidelines for Multinational Enterprises and the UN Guiding Principles on Business and Human Rights? Details:

Not applicable

Principal adverse impacts are the most significant negative impacts of investment decisions on sustainability factors relating to environmental, social and employee matters, respect for human rights, anti-corruption and anti-bribery matters.



Does this financial product consider principal adverse impacts on sustainability factors?

Yes

No

The Management Company has joined the Net Zero Asset Manager Initiative and considers PAI indicators through stewardship including engagement, both are relevant to mitigate potential adverse impact as a company.

Due to the commitment to the Net Zero Asset Manager Initiative, the Management Company aims to reduce greenhouse gas emissions in partnership with asset owner clients on decarbonisation goals, consistent with an ambition to reach net zero emission by 2050 or sooner across all assets under management. As part of this objective the Management Company will set an interim target for the proportion of assets to be managed in line with the attainment of net zero emissions by 2050 or sooner.

The Sub-Fund's Investment Manager considers PAI indicators regarding greenhouse gas emission, biodiversity, water, waste as well as social and employee matters for corporate issuers, and, where relevant, the freedom house index is applied to investments in sovereigns. PAI indicators are considered within the Investment Manager's investment process through the means of exclusions as described in the "binding elements" section of the Sub-Fund.

The data coverage for the data required for the PAI indicators is heterogenous. The data coverage related to biodiversity, water and waste is low and the related PAI indicators are considered through exclusion of securities issued by companies having a severe violation / breach of principles and guidelines such as the Principles of the United Nations Global Compact, the OECD Guidelines for Multinational Enterprises, and the United Nations Guiding Principles for Business and Human Rights on the grounds of problematic practices around human rights, labour rights, environment, and corruption issues. Therefore, the Investment Manager will strive to increase data coverage for PAI indicators with low data coverage. The Investment Manager will regularly evaluate whether the availability of data has increased sufficiently to potentially include assessment of such data in the investment process.

Additionally, PAI indicators are, among other sustainability factors, applied to derive the SRI Rating. The SRI Rating is used for the portfolio construction.

The following PAI indicators are considered:

Applicable to corporate issuers

- GHG Emissions

- Carbon footprint
- GHG Intensity of investee companies
- Exposure to companies active in the fossil fuel sector
- Activities negatively affecting biodiversity-sensitive areas
- Emissions to water
- Hazardous waste ratio
- Violation of UN Global compact principles
- Lack of processes and compliance mechanisms to monitor compliance with UN Global Compact principles
- Board gender diversity
- Exposure to controversial weapons

Applicable to sovereign and supranational issuers

- Investee countries subject to social violations

The information on the PAI indicators will be available in the end-year report of the Sub-Fund.



What investment strategy does this financial product follow?

The investment strategy guides investment decisions based on factors such as investment objectives and risk tolerance.

Allianz Strategy4Life 75's investment objective is to invest in global Equity, European Bond and Money Markets in order to achieve over the medium-term a performance comparable to a balanced portfolio within a volatility range of 8% - 16%. The assessment of the volatility of the capital markets by the Investment Manager is an important factor in this process, with the aim of typically not falling below or exceeding a volatility of the Share price within a range of 8% - 16% on a medium to long-term average, similar to a portfolio consisting of 75% global Equity Markets and 25% medium-term Euro Bond Markets in accordance with the Sustainable and Responsible Investment Strategy (SRI Strategy). In times of high volatility/ low volatility the equity market-oriented portion will be reduced/ will be increased.

As part of the SRI best-in-class approach, the Sub-Fund takes environmental, social, human rights, governance, and business behaviour factors into account as follows:

- The aforesaid sustainability factors are analysed through SRI Research by the Investment Manager in order to assess how sustainable development and long-term issues are taken into account in the strategy of an issuer. SRI Research means the overall process of identifying potential risks as well as potential opportunities of an investment in securities of an issuer related to the analysis of sustainability factors. SRI Research data combines external research data (which might have some limitations) with internal analyses.
- Based on a combination of the results of the external and/or internal analyses of the sustainability factors, an internal rating is derived monthly (SRI Rating) and is afterwards assigned to a corporate or sovereign issuer.

This internal SRI Rating is used to rank and select or weight securities for the portfolio construction.

The Sub-Fund's general investment approach (Sub-Fund's applicable General Asset Class Principles in combination with its individual investment restrictions) is described in the prospectus.

● What are the binding elements of the investment strategy used to select the investments to attain each of the environmental or social characteristics promoted by this financial product?

The binding elements are:

- Minimum rating coverage: At least 90% of the Sub-Fund's portfolio is required to have an SRI Rating (portfolio in this respect does not comprise non-rated derivatives and instruments that are non-rated by nature e.g., cash and deposits). While most holdings of the Sub-Fund will have a corresponding SRI Rating some investments cannot be rated according to the SRI Research methodology. Examples of instruments not attaining to the SRI Rating include, but are not limited to cash, deposits, Target Funds, and non-rated investments.
- The rated instruments are adhering to the minimum rating threshold of 2 (out of a rating scale from 0 – 4; 0 being the worst rating and 4 the best rating).

- Application of the following sustainable minimum exclusion criteria for direct investments:
- securities issued by companies having a severe violation / breach of principles and guidelines such as the Principles of the United Nations Global Compact, the OECD Guidelines for Multinational Enterprises, and the United Nations Guiding Principles for Business and Human Rights on the grounds of problematic practices around human rights, labour rights, environment, and corruption issues,
- securities issued by companies involved in controversial weapons (anti-personnel mines, cluster munitions, chemical weapons, biological weapons, depleted uranium, white phosphorus, and nuclear weapons),
- securities issued by companies that derive more than 10% of their revenues from weapons, military equipment, and services,
- securities issued by companies that derive more than 10% of their revenue from thermal coal extraction,
- securities issued by utility companies that generate more than 20% of their revenues from coal,
- securities issued by companies involved in the production of tobacco, and securities issued by companies involved in the distribution of tobacco with more than 5% of their revenues.

Direct investments in sovereign issuers with an insufficient freedom house index score are excluded.

The sustainable minimum exclusion criteria are based on information from an external data provider and coded in pre- and post-trade compliance. The review is performed at least half yearly.

● **What is the committed minimum rate to reduce the scope of the investments considered prior to the application of that investment strategy?**

The Sub-Fund does not commit to reduce the scope of the investments by a certain minimum rate.

● **What is the policy to assess good governance practices of the investee companies?**

Good governance principles are considered by screening out companies based on their involvement in controversies around international norms corresponding to the four good governance practices: sound management structures, employee relations, remuneration of staff and tax compliance. Companies having a severe violation in either of those areas will not be investible. For certain cases, flagged issuers shall be on a watch list. These companies will appear on this watch list when the Investment Manager believes that engagement may lead to improvements or when the company is assessed to take remedial actions. Companies on the watch list remain investible unless the Investment Manager believes that the engagement or the remedial actions of the company does not lead to the desired remedy of the severe controversy.

In addition, the Sub-Fund's Investment Manager is committed to actively encourage open dialogues with investee companies on corporate governance, proxy voting and broader sustainability issues in advance of shareholder meetings (regularly for direct investments in shares). The Sub-Fund's Investment Manager's approach to proxy voting and company engagement is set out in the Management Company's Stewardship Statement.

Good governance practices include sound management structures, employee relations, remuneration of staff and tax compliance.



What is the asset allocation planned for this financial product?

Asset allocation describes the share of investments in specific assets.

Min. 90% of the Sub-Funds' assets (excluding cash and non-rated derivatives) are used to meet the environmental or social characteristics promoted by this Sub-Fund. A low portion of the Sub-Fund might contain assets which do not promote environmental or social characteristics. Examples of such instruments are derivatives, cash and deposits, some Target Funds and investment with temporarily divergent or absent environmental, social, or good governance qualifications.

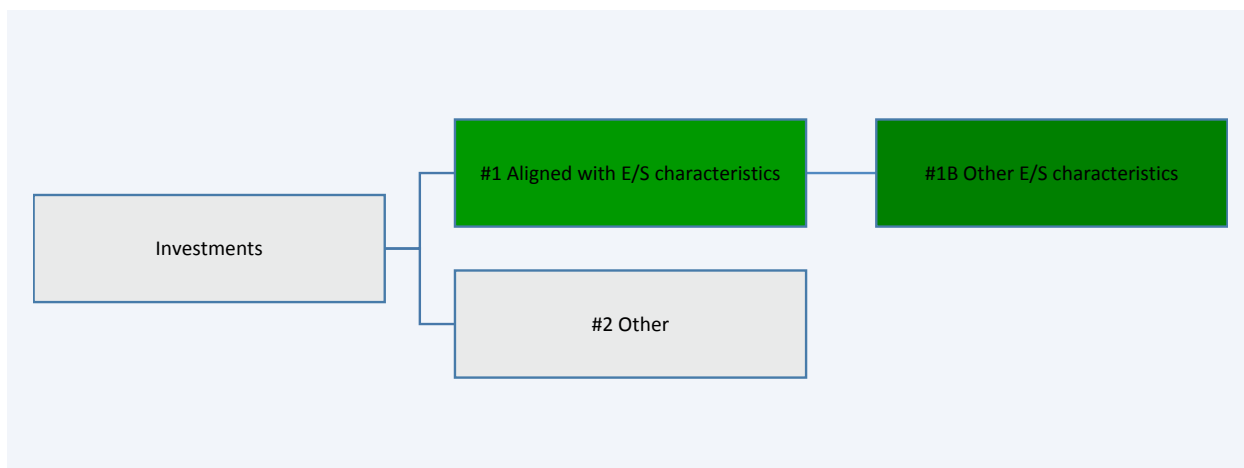

#1 Aligned with E/S characteristics includes the investments of the financial product used to attain the environmental or social characteristics promoted by the financial product.

#2 Other includes the remaining investments of the financial product which are neither aligned with the environmental or social characteristics, nor are qualified as sustainable investments.

The category **#1 Aligned with E/S characteristics** covers:

- The sub-category **#1A Sustainable** covers sustainable investments with environmental or social objectives.
- The sub-category **#1B Other E/S characteristics** covers investments aligned with the environmental or social characteristics that do not qualify as sustainable investments.

- **How does the use of derivatives attain the environmental or social characteristics promoted by the financial product?**

Not applicable



To what minimum extent are sustainable investments with an environmental objective aligned with the EU Taxonomy?

The Sub-Fund's Investment Manager does not commit to a minimum share of sustainable investments with an environmental objective aligned with the EU Taxonomy.

- **Does the financial product invest in fossil gas and/or nuclear energy related activities that comply with the EU Taxonomy¹?**

- Yes:
 - In fossil gas In nuclear energy
- No

Taxonomy-aligned activities are expressed as a share of:

- **turnover** reflecting the share of revenue from green activities of investee companies
- **capital expenditure** (CapEx) showing the green investments made by investee companies, e.g. for a transition to a green economy.
- **operational expenditure** (OpEx) reflecting green operational activities of investee companies.

¹ Fossil gas and/or nuclear related activities will only comply with the EU Taxonomy where they contribute to limiting climate change ("climate change mitigation") and do not significantly harm any EU Taxonomy objective - see explanatory note in the left hand margin. The full criteria for fossil gas and nuclear energy economic activities that comply with the EU Taxonomy are laid down in Commission Delegated Regulation (EU) 2022/1214.

The two graphs below show in green the minimum percentage of investments that are aligned with the EU Taxonomy. As there is no appropriate methodology to determine the Taxonomy-alignment of sovereign bonds*, the first graph shows the Taxonomy-alignment in relation to all the investments of the financial product including sovereign bonds, while the second graph shows the Taxonomy-alignment only in relation to the investments of the financial product other than sovereign bonds.

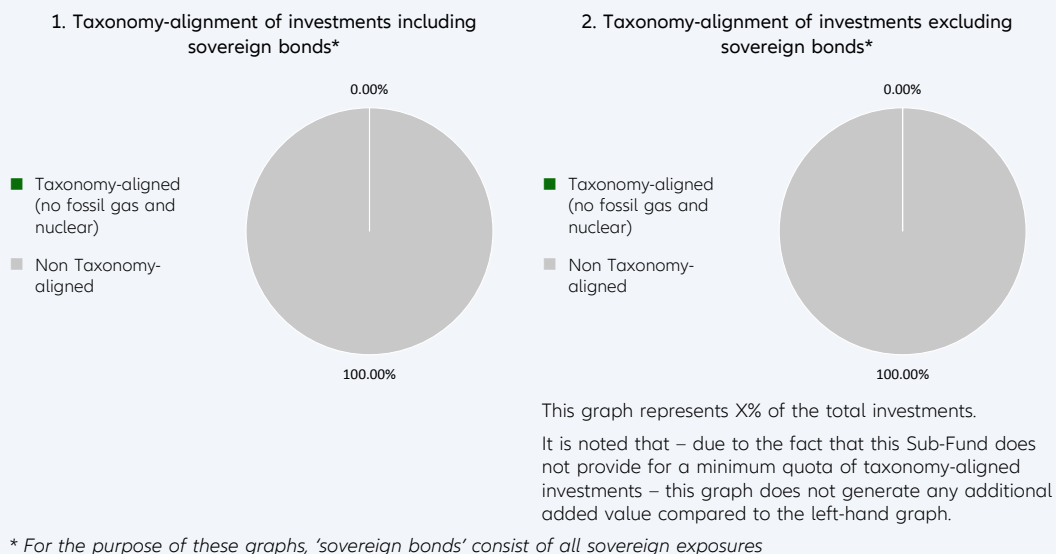

Enabling activities directly enable other activities to make a substantial contribution to an environmental objective.

● **What is the minimum share of investments in transitional and enabling activities?**

The Sub-Fund’s Investment Manager does not commit to a split of minimum taxonomy alignment into transitional, enabling activities and own performance.

Transitional activities are activities for which low-carbon alternatives are not yet available and among others have greenhouse gas emission levels corresponding to the best performance.



What is the minimum share of sustainable investments with an environmental objective that are not aligned with the EU Taxonomy?

The Sub-Fund’s Investment Manager does not commit to a minimum share of investments with an environmental objective that are not aligned with the EU Taxonomy.



are sustainable investments with an environmental objective that **do not take into account the criteria** for environmentally sustainable economic activities under the EU Taxonomy.



What is the minimum share of socially sustainable investments?

The Sub-Fund’s Investment Manager does not commit to a minimum share of socially sustainable investments.



What investments are included under “#2 Other”, what is their purpose and are there any minimum environmental or social safeguards?

Under “#2 Other” investments into cash, Target Funds, or derivatives can be included. Derivatives might be used for efficient portfolio management (including risk hedging) and/or investment purposes, and Target Funds to benefit from a specific strategy. For those investments no environmental or social safeguards are applied.



Is a specific index designated as a reference benchmark to determine whether this financial product is aligned with the environmental and/or social characteristics that it promotes?

No reference benchmark has been designated for the purpose of attaining the environmental and/or social characteristics promoted by the Sub-Fund.

Reference benchmarks are indexes to measure whether the financial product attains the environmental or social characteristics that they promote.

- How is the reference benchmark continuously aligned with each of the environmental or social characteristics promoted by the financial product?
Not applicable
- How is the alignment of the investment strategy with the methodology of the index ensured on a continuous basis?
Not applicable
- How does the designated index differ from a relevant broad market index?
Not applicable
- Where can the methodology used for the calculation of the designated index be found?
Not applicable



Where can I find more product specific information online?

More product-specific information can be found on the website: <https://regulatory.allianzgi.com/SFDR>

Template pre-contractual disclosure for the financial products referred to in Article 8, paragraphs 1, 2 and 2a, of Regulation (EU) 2019/2088 and Article 6, first paragraph, of Regulation (EU) 2020/852

Product name:

Allianz Strategy4Life Europe 40

Legal entity identifier: 529900VGMX20P6DTP861

Environmental and/or social characteristics

Sustainable investment means an investment in an economic activity that contributes to an environmental or social objective, provided that the investment does not significantly harm any environmental or social objective and that the investee companies follow good governance practices.

The **EU Taxonomy** is a classification system laid down in Regulation (EU) 2020/852, establishing a list of **environmentally sustainable economic activities**. That Regulation does not include a list of socially sustainable economic activities. Sustainable investments with an environmental objective might be aligned with the Taxonomy or not.

Does this financial product have a sustainable investment objective?

Yes

No

It will make a minimum of **sustainable investments with an environmental objective**: ___%

in economic activities that qualify as environmentally sustainable under the EU Taxonomy

in economic activities that do not qualify as environmentally sustainable under the EU Taxonomy

It will make a minimum of **sustainable investments with a social objective** ___%

It **promotes Environmental/Social (E/S) characteristics** and while it does not have as its objective a sustainable investment, it will have a minimum proportion of ___% of sustainable investments

with an environmental objective in economic activities that qualify as environmentally sustainable under the EU Taxonomy

with an environmental objective in economic activities that do not qualify as environmentally sustainable under the EU Taxonomy

with a social objective

It promotes E/S characteristics, but **will not make any sustainable investments**



What environmental and/or social characteristics are promoted by this financial product?

Allianz Strategy4Life Europe 40 (the "Sub-Fund") promotes environmental, social, human rights, governance, and business behaviour factors (this domain does not apply for sovereigns issued by a Sovereign Entity) through integration of a best-in-class approach into the Sub-Fund's investment process. This encompasses the evaluation of corporate or sovereign issuers based on an SRI Rating which is used to construct the portfolio.

In addition, sustainable minimum exclusion criteria apply.

No reference benchmark has been designated for the purpose of attaining the environmental and/or social characteristics promoted by the Sub-Fund.

● What sustainability indicators are used to measure the attainment of each of the environmental or social characteristics promoted by this financial product?

To measure the attainment of the environmental and/or social characteristics the following sustainability indicators are used and reported on, at the fiscal year end:

- The actual percentage of the Sub-Fund's Portfolio (Portfolio in this respect does not comprise non-rated derivatives and instruments that are non-rated by nature (e. g., cash and deposits)) assets invested in best-in-class issuers (issuers with a minimum SRI Rating of 2 out of a scale from 0-4; 0 being the worst rating and 4 the best rating).
- Confirmation that Principal Adverse Impacts (PAIs) of investment decisions on sustainability factors are considered through the application of exclusion criteria.

Sustainability indicators measure how the environmental or social characteristics promoted by the financial product are attained.

- What are the objectives of the sustainable investments that the financial product partially intends to make and how does the sustainable investment contribute to such objectives?

Not applicable

- How do the sustainable investments that the financial product partially intends to make, not cause significant harm to any environmental or social sustainable investment objective?

Not applicable

- How have the indicators for adverse impacts on sustainability factors been taken into account?

Not applicable

- How are the sustainable investments aligned with the OECD Guidelines for Multinational Enterprises and the UN Guiding Principles on Business and Human Rights? Details:

Not applicable

Principal adverse impacts are the most significant negative impacts of investment decisions on sustainability factors relating to environmental, social and employee matters, respect for human rights, anti-corruption and anti-bribery matters.



Does this financial product consider principal adverse impacts on sustainability factors?

Yes

No

The Management Company has joined the Net Zero Asset Manager Initiative and considers PAI indicators through stewardship including engagement, both are relevant to mitigate potential adverse impact as a company.

Due to the commitment to the Net Zero Asset Manager Initiative, the Management Company aims to reduce greenhouse gas emissions in partnership with asset owner clients on decarbonisation goals, consistent with an ambition to reach net zero emission by 2050 or sooner across all assets under management. As part of this objective the Management Company will set an interim target for the proportion of assets to be managed in line with the attainment of net zero emissions by 2050 or sooner.

The Sub-Fund's Investment Manager considers PAI indicators regarding greenhouse gas emission, biodiversity, water, waste as well as social and employee matters for corporate issuers, and, where relevant, the freedom house index is applied to investments in sovereigns. PAI indicators are considered within the Investment Manager's investment process through the means of exclusions as described in the "binding elements" section of the Sub-Fund.

The data coverage for the data required for the PAI indicators is heterogenous. The data coverage related to biodiversity, water and waste is low and the related PAI indicators are considered through exclusion of securities issued by companies having a severe violation / breach of principles and guidelines such as the Principles of the United Nations Global Compact, the OECD Guidelines for Multinational Enterprises, and the United Nations Guiding Principles for Business and Human Rights on the grounds of problematic practices around human rights, labour rights, environment, and corruption issues. Therefore, the Investment Manager will strive to increase data coverage for PAI indicators with low data coverage. The Investment Manager will regularly evaluate whether the availability of data has increased sufficiently to potentially include assessment of such data in the investment process.

Additionally, PAI indicators are, among other sustainability factors, applied to derive the SRI Rating. The SRI Rating is used for the portfolio construction.

The following PAI indicators are considered:

Applicable to corporate issuers

- GHG Emissions

- Carbon footprint
- GHG Intensity of investee companies
- Exposure to companies active in the fossil fuel sector
- Activities negatively affecting biodiversity-sensitive areas
- Emissions to water
- Hazardous waste ratio
- Violation of UN Global compact principles
- Lack of processes and compliance mechanisms to monitor compliance with UN Global Compact principles
- Board gender diversity
- Exposure to controversial weapons

Applicable to sovereign and supranational issuers

- Investee countries subject to social violations

The information on the PAI indicators will be available in the end-year report of the Sub-Fund.



What investment strategy does this financial product follow?

The investment strategy guides investment decisions based on factors such as investment objectives and risk tolerance.

Allianz Strategy4Life Europe 40's investment objective is to invest in European Equity, European Bond and Money Markets in order to achieve over the medium-term a performance comparable to a balanced portfolio within a volatility range of 3% - 9%. The assessment of the volatility of the capital markets by the Investment Manager is an important factor in this process, with the aim of typically not falling below or exceeding a volatility of the Share price within a range of 3% - 9% on a medium to long-term average, similar to a portfolio consisting of 40% European Equity Markets and 60% medium-term Euro Bond Markets in accordance with the Sustainable and Responsible Investment Strategy (SRI Strategy). In times of high volatility / low volatility the equity market-oriented portion will be reduced / will be increased.

As part of the SRI best-in-class approach, the Sub-Fund takes environmental, social, human rights, governance, and business behaviour factors into account as follows:

- The aforesaid sustainability factors are analysed through SRI Research by the Investment Manager in order to assess how sustainable development and long-term issues are taken into account in the strategy of an issuer. SRI Research means the overall process of identifying potential risks as well as potential opportunities of an investment in securities of an issuer related to the analysis of sustainability factors. SRI Research data combines external research data (which might have some limitations) with internal analyses.
- Based on a combination of the results of the external and/or internal analyses of the sustainability factors, an internal rating is derived monthly (SRI Rating) and is afterwards assigned to a corporate or sovereign issuer.

This internal SRI Rating is used to rank and select or weight securities for the portfolio construction.

The Sub-Fund's general investment approach (Sub-Fund's applicable General Asset Class Principles in combination with its individual investment restrictions) is described in the prospectus.

● What are the binding elements of the investment strategy used to select the investments to attain each of the environmental or social characteristics promoted by this financial product?

The binding elements are:

- Minimum rating coverage: At least 90% of the Sub-Fund's portfolio is required to have an SRI Rating (portfolio in this respect does not comprise non-rated derivatives and instruments that are non-rated by nature e.g., cash and deposits). While most holdings of the Sub-Fund will have a corresponding SRI Rating some investments cannot be rated according to the SRI Research methodology. Examples of instruments not attaining to the SRI Rating include, but are not limited to cash, deposits, Target Funds, and non-rated investments.
- The rated instruments are adhering to the minimum rating threshold of 2 (out of a rating scale from 0 – 4; 0 being the worst rating and 4 the best rating).

- Application of the following sustainable minimum exclusion criteria for direct investments:
- securities issued by companies having a severe violation / breach of principles and guidelines such as the Principles of the United Nations Global Compact, the OECD Guidelines for Multinational Enterprises, and the United Nations Guiding Principles for Business and Human Rights on the grounds of problematic practices around human rights, labour rights, environment, and corruption issues,
- securities issued by companies involved in controversial weapons (anti-personnel mines, cluster munitions, chemical weapons, biological weapons, depleted uranium, white phosphorus, and nuclear weapons),
- securities issued by companies that derive more than 10% of their revenues from weapons, military equipment, and services,
- securities issued by companies that derive more than 10% of their revenue from thermal coal extraction,
- securities issued by utility companies that generate more than 20% of their revenues from coal,
- securities issued by companies involved in the production of tobacco, and securities issued by companies involved in the distribution of tobacco with more than 5% of their revenues.

Direct investments in sovereign issuers with an insufficient freedom house index score are excluded.

The sustainable minimum exclusion criteria are based on information from an external data provider and coded in pre- and post-trade compliance. The review is performed at least half yearly.

● **What is the committed minimum rate to reduce the scope of the investments considered prior to the application of that investment strategy?**

The Sub-Fund does not commit to reduce the scope of the investments by a certain minimum rate.

● **What is the policy to assess good governance practices of the investee companies?**

Good governance principles are considered by screening out companies based on their involvement in controversies around international norms corresponding to the four good governance practices: sound management structures, employee relations, remuneration of staff and tax compliance. Companies having a severe violation in either of those areas will not be investible. For certain cases, flagged issuers shall be on a watch list. These companies will appear on this watch list when the Investment Manager believes that engagement may lead to improvements or when the company is assessed to take remedial actions. Companies on the watch list remain investible unless the Investment Manager believes that the engagement or the remedial actions of the company does not lead to the desired remedy of the severe controversy.

In addition, the Sub-Fund's Investment Manager is committed to actively encourage open dialogues with investee companies on corporate governance, proxy voting and broader sustainability issues in advance of shareholder meetings (regularly for direct investments in shares). The Sub-Fund's Investment Manager's approach to proxy voting and company engagement is set out in the Management Company's Stewardship Statement.

Good governance practices include sound management structures, employee relations, remuneration of staff and tax compliance.



What is the asset allocation planned for this financial product?

Asset allocation describes the share of investments in specific assets.

Min. 90% of the Sub-Funds' assets (excluding cash and non-rated derivatives) are used to meet the environmental or social characteristics promoted by this Sub-Fund. A low portion of the Sub-Fund might contain assets which do not promote environmental or social characteristics. Examples of such instruments are derivatives, cash and deposits, some Target Funds and investment with temporarily divergent or absent environmental, social, or good governance qualifications.

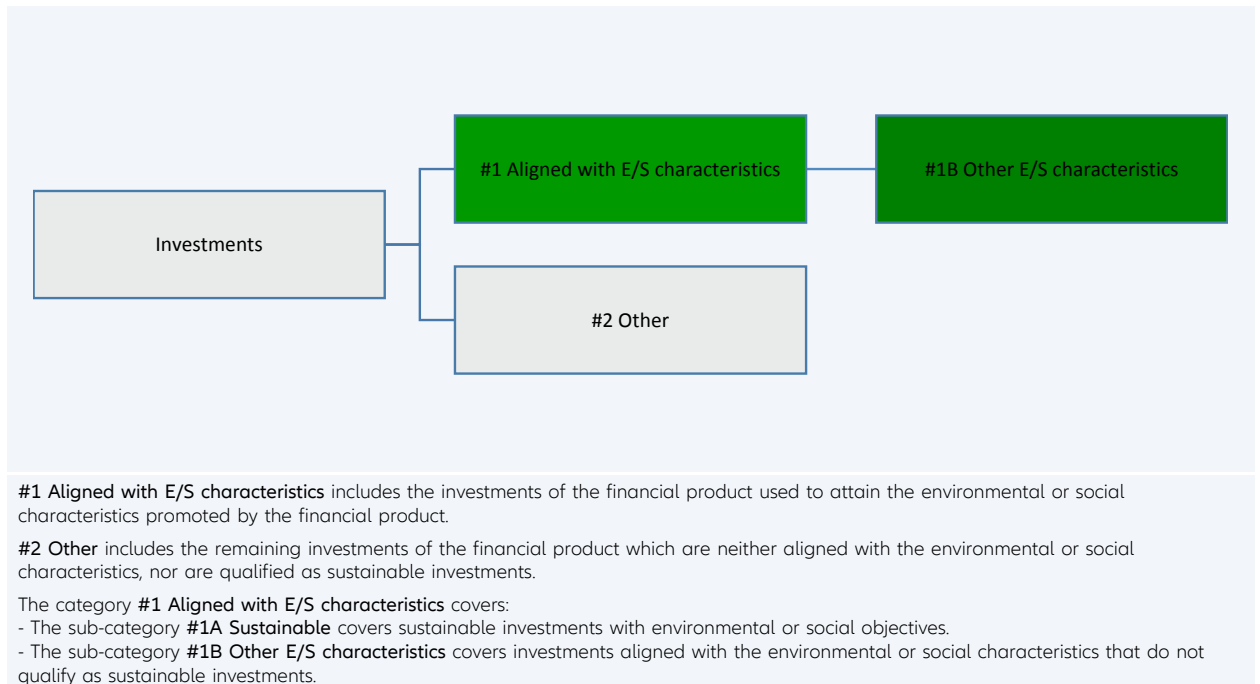

- **How does the use of derivatives attain the environmental or social characteristics promoted by the financial product?**

Not applicable



To what minimum extent are sustainable investments with an environmental objective aligned with the EU Taxonomy?

The Sub-Fund's Investment Manager does not commit to a minimum share of sustainable investments with an environmental objective aligned with the EU Taxonomy.

- **Does the financial product invest in fossil gas and/or nuclear energy related activities that comply with the EU Taxonomy¹?**

Yes:

In fossil gas In nuclear energy

No

Taxonomy-aligned activities are expressed as a share of:

- **turnover** reflecting the share of revenue from green activities of investee companies
- **capital expenditure** (CapEx) showing the green investments made by investee companies, e.g. for a transition to a green economy.
- **operational expenditure** (OpEx) reflecting green operational activities of investee companies.

¹ Fossil gas and/or nuclear related activities will only comply with the EU Taxonomy where they contribute to limiting climate change ("climate change mitigation") and do not significantly harm any EU Taxonomy objective - see explanatory note in the left hand margin. The full criteria for fossil gas and nuclear energy economic activities that comply with the EU Taxonomy are laid down in Commission Delegated Regulation (EU) 2022/1214.

The two graphs below show in green the minimum percentage of investments that are aligned with the EU Taxonomy. As there is no appropriate methodology to determine the Taxonomy-alignment of sovereign bonds*, the first graph shows the Taxonomy-alignment in relation to all the investments of the financial product including sovereign bonds, while the second graph shows the Taxonomy-alignment only in relation to the investments of the financial product other than sovereign bonds.

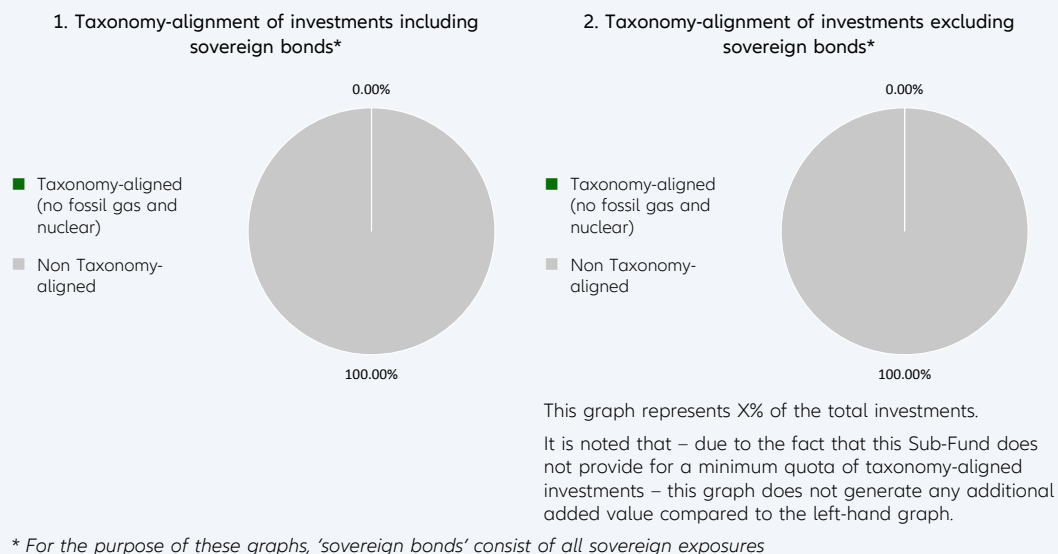

Enabling activities directly enable other activities to make a substantial contribution to an environmental objective.

Transitional activities are activities for which low-carbon alternatives are not yet available and among others have greenhouse gas emission levels corresponding to the best performance.

● **What is the minimum share of investments in transitional and enabling activities?**

The Sub-Fund’s Investment Manager does not commit to a split of minimum taxonomy alignment into transitional, enabling activities and own performance.



What is the minimum share of sustainable investments with an environmental objective that are not aligned with the EU Taxonomy?

The Sub-Fund’s Investment Manager does not commit to a minimum share of investments with an environmental objective that are not aligned with the EU Taxonomy.



are sustainable investments with an environmental objective that **do not take into account the criteria** for environmentally sustainable economic activities under the EU Taxonomy.



What is the minimum share of socially sustainable investments?

The Sub-Fund’s Investment Manager does not commit to a minimum share of socially sustainable investments.



What investments are included under “#2 Other”, what is their purpose and are there any minimum environmental or social safeguards?

Under “#2 Other” investments into cash, Target Funds, or derivatives can be included. Derivatives might be used for efficient portfolio management (including risk hedging) and/or investment purposes, and Target Funds to benefit from a specific strategy. For those investments no environmental or social safeguards are applied.



Is a specific index designated as a reference benchmark to determine whether this financial product is aligned with the environmental and/or social characteristics that it promotes?

No reference benchmark has been designated for the purpose of attaining the environmental and/or social characteristics promoted by the Sub-Fund.

Reference benchmarks are indexes to measure whether the financial product attains the environmental or social characteristics that they promote.

- How is the reference benchmark continuously aligned with each of the environmental or social characteristics promoted by the financial product?
Not applicable
- How is the alignment of the investment strategy with the methodology of the index ensured on a continuous basis?
Not applicable
- How does the designated index differ from a relevant broad market index?
Not applicable
- Where can the methodology used for the calculation of the designated index be found?
Not applicable



Where can I find more product specific information online?

More product-specific information can be found on the website: <https://regulatory.allianzgi.com/SFDR>

Template pre-contractual disclosure for the financial products referred to in Article 8, paragraphs 1, 2 and 2a, of Regulation (EU) 2019/2088 and Article 6, first paragraph, of Regulation (EU) 2020/852

Product name:

Allianz Sustainable Health Evolution

Legal entity identifier: 529900QNFA91WJ6M3Q96

Environmental and/or social characteristics

Sustainable investment means an investment in an economic activity that contributes to an environmental or social objective, provided that the investment does not significantly harm any environmental or social objective and that the investee companies follow good governance practices.

The **EU Taxonomy** is a classification system laid down in Regulation (EU) 2020/852, establishing a list of **environmentally sustainable economic activities**. That Regulation does not include a list of socially sustainable economic activities. Sustainable investments with an environmental objective might be aligned with the Taxonomy or not.

Does this financial product have a sustainable investment objective?	
<input checked="" type="radio"/> <input checked="" type="radio"/> Yes	<input checked="" type="radio"/> <input type="radio"/> No
<input type="checkbox"/> It will make a minimum of sustainable investments with an environmental objective: ___% <ul style="list-style-type: none"> <input type="checkbox"/> in economic activities that qualify as environmentally sustainable under the EU Taxonomy <input type="checkbox"/> in economic activities that do not qualify as environmentally sustainable under the EU Taxonomy 	<input checked="" type="checkbox"/> It promotes Environmental/Social (E/S) characteristics and while it does not have as its objective a sustainable investment, it will have a minimum proportion of 50.00% of sustainable investments <ul style="list-style-type: none"> <input checked="" type="checkbox"/> with an environmental objective in economic activities that qualify as environmentally sustainable under the EU Taxonomy <input checked="" type="checkbox"/> with an environmental objective in economic activities that do not qualify as environmentally sustainable under the EU Taxonomy <input checked="" type="checkbox"/> with a social objective
<input type="checkbox"/> It will make a minimum of sustainable investments with a social objective ___%	<input type="checkbox"/> It promotes E/S characteristics, but will not make any sustainable investments



What environmental and/or social characteristics are promoted by this financial product?

Allianz Sustainable Health Evolution’s (the “Sub-Fund”) invests in securities of companies providing products or services which contribute to environmental or social objectives, as defined by the UN Sustainable Development Goals (SDGs) or the EU Taxonomy objectives, which are also related to the SDGs. The contribution is measured according to the Sustainable Investment methodology.

In addition, sustainable minimum exclusion criteria apply.

No reference benchmark has been designated for the purpose of attaining the environmental and/or social characteristics promoted by the Sub-Fund.

● What sustainability indicators are used to measure the attainment of each of the environmental or social characteristics promoted by this financial product?

To measure the attainment of the Sub-Fund's sustainable investment objective the following sustainability indicators are used and reported on, at the fiscal year end:

- The actual Sustainable Investment share – which is based on SDGs or EU Taxonomy objectives
- Principle Adverse Impacts (PAIs) of investment decisions on sustainability factors are considered through the application of exclusion criteria.

Sustainability indicators measure how the environmental or social characteristics promoted by the financial product are attained.

- **What are the objectives of the sustainable investments that the financial product partially intends to make and how does the sustainable investment contribute to such objectives?**

Sustainable investments contribute to environmental and/or social objectives, for which the Investment Manager uses as reference frameworks, among others, the UN Sustainable Development Goals (SDGs), as well as the objectives of the EU Taxonomy:

1. Climate Change Mitigation
2. Climate Change Adaptation
3. Sustainable Use and Protection of Water and Marine Resources
4. Transition to a Circular Economy
5. Pollution Prevention and Control
6. Protection and Restoration of Biodiversity and Ecosystems

The assessment of the positive contribution to the environmental or social objectives is based on a proprietary framework which combines quantitative elements with qualitative inputs from internal research. The methodology applies first a quantitative breakdown of a securities issuer into its business activities. The qualitative element of the framework is an assessment if business activities contribute positively to an environmental or a social objective.

To calculate the positive contribution on the Sub-Fund level the revenue share of each issuer attributable to business activities contributing to environmental and/or social objectives is considered provided the issuer is satisfying the Do No Significant Harm (“DNSH”) and Good Governance principles, and an asset-weighted aggregation is performed as a second step. Moreover, for certain types of securities, which finance specific projects contributing to environmental or social objectives the overall investment is considered to contribute to environmental and/or social objectives, but also for these a DNSH as well as a Good Governance check for issuers is performed.

- **How do the sustainable investments that the financial product partially intends to make, not cause significant harm to any environmental or social sustainable investment objective?**

In order to ensure that Sustainable Investments do not significantly harm any other environmental and/or social objective, the Investment Manager is leveraging the PAI indicators, whereby significance thresholds have been defined to identify significantly harmful issuers. Issuers not meeting the significance threshold can be engaged for a limited time period to remediate the adverse impact. Otherwise, if the issuer does not meet the defined significance thresholds twice subsequently or in case of a failed engagement, it does not pass the DNSH assessment. Investments in securities of issuers which do not pass the DNSH assessment are not counted as sustainable investments.

- *How have the indicators for adverse impacts on sustainability factors been taken into account?*

All mandatory PAI indicators are considered either as part of the application of the exclusion criteria or through thresholds on a sectorial or absolute basis. Significance thresholds have been defined and they refer to qualitative or quantitative criteria.

Recognizing the lack of data coverage for some of the PAI indicators equivalent data points are used to assess PAI indicators when applying the DNSH assessment, when relevant, for the following indicators for corporates: share of non-renewable energy consumption and production, activities negatively affecting biodiversity-sensitive areas, emissions to water, lack of processes and compliance mechanisms to monitor compliance with UNGC principles and OECD Guidelines for Multinational Enterprises; for sovereigns: GHG Intensity and investee countries subject to social violations. In case of securities which finance specific projects contributing to environmental or social objectives equivalent data at project level might be used to ensure that Sustainable Investments do not significantly harm any other environmental and/or social objective. The Investment Manager will strive to increase data coverage for PAI indicators with low data coverage by engaging with issuers and data providers. The Investment Manager will regularly evaluate whether the availability of data has increased sufficiently to potentially include assessment of such data in the investment process.

- *How are the sustainable investments aligned with the OECD Guidelines for Multinational Enterprises and the UN Guiding Principles on Business and Human Rights? Details:*

The Investment Manager’s sustainable minimum exclusion list screens out companies based on their involvement in controversial practices against international norms. The core normative framework consists of the Principles of the UN Global Compact, the OECD Guidelines for Multinational Enterprises

Principal adverse impacts are the most significant negative impacts of investment decisions on sustainability factors relating to environmental, social and employee matters, respect for human rights, anti-corruption and anti-bribery matters.

and the UN Guiding Principles for Business and Human Rights. Securities issued by companies having a severe violation of these frameworks will be restricted from the investment universe.

The EU Taxonomy sets out a “do not significant harm” principle by which Taxonomy-aligned investments should not significantly harm EU Taxonomy objectives and is accompanied by specific EU criteria.

The “do not significant harm” principle applies only to those investments underlying the financial product that take into account the EU criteria for environmentally sustainable economic activities. The investments underlying the remaining portion of this financial product do not take into account the EU criteria for environmentally sustainable economic activities.

Any other sustainable investments must also not significantly harm any environmental or social objectives.



Does this financial product consider principal adverse impacts on sustainability factors?

Yes

No

The Management Company has joined the Net Zero Asset Manager Initiative and considers PAI indicators through stewardship including engagement, both are relevant to mitigate potential adverse impact as a company.

Due to the commitment to the Net Zero Asset Manager Initiative, the Management Company aims to reduce greenhouse gas emissions in partnership with asset owner clients on decarbonisation goals, consistent with an ambition to reach net zero emission by 2050 or sooner across all assets under management. As part of this objective the Management Company will set an interim target for the proportion of assets to be managed in line with the attainment of net zero emissions by 2050 or sooner.

The Sub-Fund’s Investment Manager considers PAI indicators regarding greenhouse gas emission, biodiversity, water, waste as well as social and employee matters for corporate issuers, and, where relevant, the freedom house index is applied to investments in sovereigns. PAI indicators are considered within the Investment Manager’s investment process through the means of exclusions as described in the “binding elements” section of the Sub-Fund.

The data coverage for the data required for the PAI indicators is heterogenous. The data coverage related to biodiversity, water and waste is low and the related PAI indicators are considered through exclusion of securities issued by companies having a severe violation / breach of principles and guidelines such as the Principles of the United Nations Global Compact, the OECD Guidelines for Multinational Enterprises, and the United Nations Guiding Principles for Business and Human Rights on the grounds of problematic practices around human rights, labour rights, environment, and corruption issues. Therefore, the Investment Manager will strive to increase data coverage for PAI indicators with low data coverage. The Investment Manager will regularly evaluate whether the availability of data has increased sufficiently to potentially include assessment of such data in the investment process.

Additionally, PAI indicators are considered as part of the requirement of the Sub-Fund to invest 50% into Sustainable Investments. PAI indicators are used as part of the DNSH assessment. Investments in securities of issuers who do not pass the DNSH assessment are not counted as sustainable investments.

The following PAI indicators are considered:

Applicable to corporate issuers

- GHG Emissions
- Carbon footprint
- GHG Intensity of investee companies
- Exposure to companies active in the fossil fuel sector
- Share of non-renewable energy consumption and production
- Energy consumption intensity per high impact climate sector
- Activities negatively affecting biodiversity-sensitive areas
- Emissions to water
- Hazardous waste ratio
- Violation of UN Global compact principles

- Lack of processes and compliance mechanisms to monitor compliance with UN Global Compact principles
- Unadjusted gender pay gap
- Board gender diversity
- Exposure to controversial weapons

Applicable to sovereign and supranational issuers

- GHG Intensity
- Investee countries subject to social violations

The information on the PAI indicators will be available in the end-year report of the Sub-Fund.



What investment strategy does this financial product follow?

The investment strategy guides investment decisions based on factors such as investment objectives and risk tolerance.

Allianz Sustainable Health Evolution's investment objective is to invest in global Equity Markets with a focus on companies with an engagement in the area of health innovation and promotion in accordance with the SDG-Aligned Strategy.

The Sub-Fund invests in Equities of companies which offer products and services across themes of health innovation and promotion. Companies which engage in the area of health innovation and promotion are companies offering products or services that enable a healthy and sustainable lifestyle through (i) preventing illness (fitness, nutrition and lifestyle changes to help reduce the risk of disease), (ii) prescribing treatment (medicine, therapy, surgery etc.. to help lessen the symptoms and effects of a disease) and (iii) prolonging life (technology, tools, research, science etc.. to lengthen life span) as targeted by the SDG's No. 2, 3, 6, 11 and 12.

The Sub-Fund's general investment approach (Sub-Fund's applicable General Asset Class Principles in combination with its individual investment restrictions) is described in the prospectus.

● What are the binding elements of the investment strategy used to select the investments to attain each of the environmental or social characteristics promoted by this financial product?

The binding elements are:

- Minimum 50% of the Sub-Fund assets' weighted average shall result from revenue generated from issuers' activities that facilitate the achievement of one or more SDG or EU Taxonomy objectives as measured according to the Sustainable Investment methodology.
- For at least 80% of the Sub-Fund portfolio, the respective issuer shall have a minimum share of 20% Sustainable Investments. Cash and derivatives are excluded from the aforesaid thresholds.
- Application of the following sustainable minimum exclusion criteria for direct investments:
 - securities issued by companies having a severe violation / breach of principles and guidelines such as the Principles of the United Nations Global Compact, the OECD Guidelines for Multinational Enterprises, and the United Nations Guiding Principles for Business and Human Rights on the grounds of problematic practices around human rights, labour rights, environment, and corruption issues,
 - securities issued by companies involved in controversial weapons (anti-personnel mines, cluster munitions, chemical weapons, biological weapons, depleted uranium, white phosphorus, and nuclear weapons),
 - securities issued by companies that derive more than 10% of their revenues from weapons, military equipment, and services,
 - securities issued by companies that derive more than 10% of their revenue from thermal coal extraction,
 - securities issued by utility companies that generate more than 20% of their revenues from coal,
 - securities issued by companies involved in the production of tobacco, and securities issued by companies involved in the distribution of tobacco with more than 5% of their revenues.

Direct investments in sovereign issuers with an insufficient freedom house index score are excluded.

The sustainable minimum exclusion criteria are based on information from an external data provider and coded in pre- and post-trade compliance. The review is performed at least half yearly.

- **What is the committed minimum rate to reduce the scope of the investments considered prior to the application of that investment strategy?**

The Sub-Fund does not commit to reduce the scope of the investments by a certain minimum rate.

- **What is the policy to assess good governance practices of the investee companies?**

Good governance principles are considered by screening out companies based on their involvement in controversies around international norms corresponding to the four good governance practices: sound management structures, employee relations, remuneration of staff and tax compliance. Companies having a severe violation in either of those areas will not be investible. For certain cases, flagged issuers shall be on a watch list. These companies will appear on this watch list when the Investment Manager believes that engagement may lead to improvements or when the company is assessed to take remedial actions. Companies on the watch list remain investible unless the Investment Manager believes that the engagement or the remedial actions of the company does not lead to the desired remedy of the severe controversy.

In addition, the Sub-Fund's Investment Manager is committed to actively encourage open dialogues with investee companies on corporate governance, proxy voting and broader sustainability issues in advance of shareholder meetings (regularly for direct investments in shares). The Sub-Fund's Investment Manager's approach to proxy voting and company engagement is set out in the Management Company's Stewardship Statement.

Good governance practices include sound management structures, employee relations, remuneration of staff and tax compliance.



What is the asset allocation planned for this financial product?

Asset allocation describes the share of investments in specific assets.

Min. 80% of the Sub-Funds' assets (excluding cash, and derivatives) are used to meet the environmental or social characteristics promoted by this Sub-Fund. A low portion of the Sub-Fund might contain assets which do not promote environmental or social characteristics. Example of such instruments are derivatives, cash and deposits, some Target Funds and investment with temporarily divergent or absent environmental, social, or good governance qualifications. The Sub-Fund invest primarily into securities which offer products and services to facilitate the achievements of the SDGs. Min. 50% of the Sub-Funds' assets will be invested in Sustainable Investments. The Sub-Fund's Investment Manager does not commit to a minimum share of sustainable investments with an environmental objective aligned with the EU Taxonomy nor to a minimum share of environmentally Sustainable Investments that are not aligned with the EU Taxonomy. The Sub-Fund's Investment Manager does not commit to a minimum share of socially sustainable investments. While the Sub-Fund cannot commit to a minimum share of environmentally or socially sustainable investments, such investments may be freely allocated to within the Sub-Fund aggregated sustainable investment commitment disclosed (min. 50%).

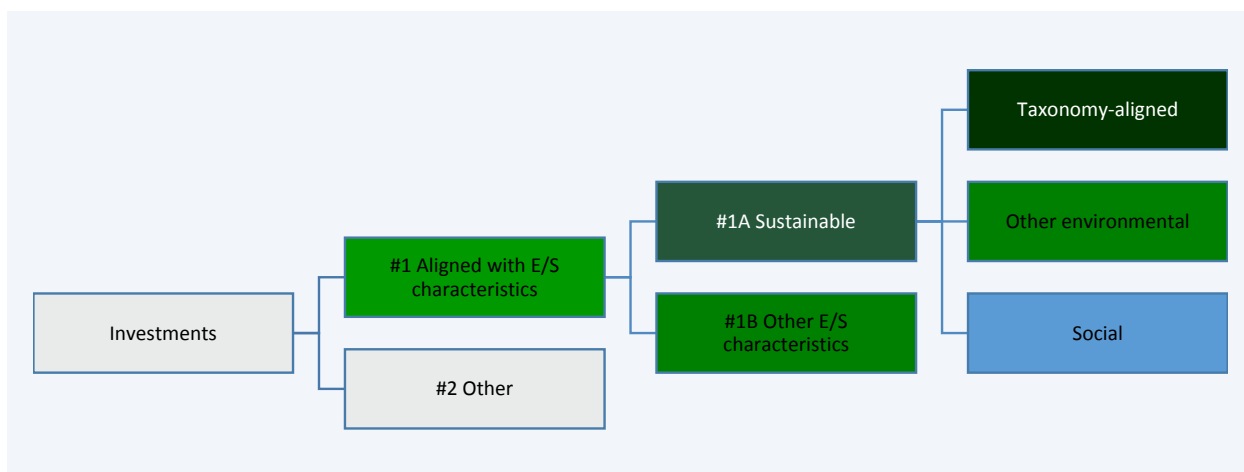

#1 Aligned with E/S characteristics includes the investments of the financial product used to attain the environmental or social characteristics promoted by the financial product.

#2 Other includes the remaining investments of the financial product which are neither aligned with the environmental or social characteristics, nor are qualified as sustainable investments.

The category **#1 Aligned with E/S characteristics** covers:

- The sub-category **#1A Sustainable** covers sustainable investments with environmental or social objectives.
- The sub-category **#1B Other E/S characteristics** covers investments aligned with the environmental or social characteristics that do not qualify as sustainable investments.

- How does the use of derivatives attain the environmental or social characteristics promoted by the financial product?

Not applicable



To what minimum extent are sustainable investments with an environmental objective aligned with the EU Taxonomy?

The Sub-Fund’s Investment Manager does not commit to a minimum share of sustainable investments with an environmental objective aligned with the EU Taxonomy. The overall sustainable investment share may also include investments with an environmental objective in economic activities that qualify as environmentally sustainable under the EU Taxonomy.

- Does the financial product invest in fossil gas and/or nuclear energy related activities that comply with the EU Taxonomy ¹?

- Yes:
 - In fossil gas In nuclear energy
- No

The Sub-Fund does not pursue any investments in fossil gas and/or nuclear energy related activities that comply with the EU Taxonomy. Nevertheless, as result of this investment strategy, investments may occur in corporates which are also active in these activities. Further information will be provided as part of the annual reporting, if relevant.

The two graphs below show in green the minimum percentage of investments that are aligned with the EU Taxonomy. As there is no appropriate methodology to determine the Taxonomy-alignment of sovereign bonds, the first graph shows the Taxonomy-alignment in relation to all the investments of the financial product including sovereign bonds, while the second graph shows the Taxonomy-alignment only in relation to the investments of the financial product other than sovereign bonds.*

1. Taxonomy-alignment of investments including sovereign bonds*

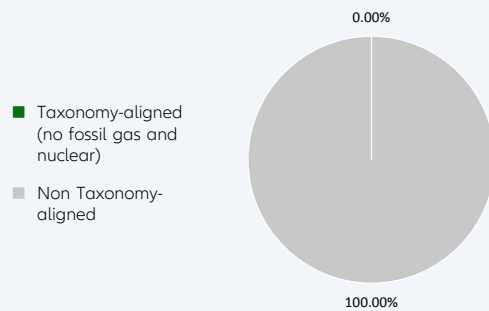

2. Taxonomy-alignment of investments excluding sovereign bonds*

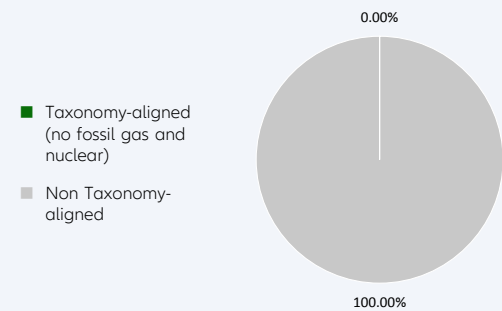

This graph represents X% of the total investments. It is noted that – due to the fact that this Sub-Fund does not provide for a minimum quota of taxonomy-aligned investments – this graph does not generate any additional added value compared to the left-hand graph.

* For the purpose of these graphs, ‘sovereign bonds’ consist of all sovereign exposures

- What is the minimum share of investments in transitional and enabling activities?

The Sub-Fund’s Investment Manager does not commit to a split of minimum taxonomy alignment into transitional, enabling activities and own performance.

Taxonomy-aligned activities are expressed as a share of:

- **turnover** reflecting the share of revenue from green activities of investee companies
- **capital expenditure** (CapEx) showing the green investments made by investee companies, e.g. for a transition to a green economy.
- **operational expenditure** (OpEx) reflecting green operational activities of investee companies.

Enabling activities directly enable other activities to make a substantial contribution to an environmental objective.

Transitional activities are activities for which low-carbon alternatives are not yet available

¹ Fossil gas and/or nuclear related activities will only comply with the EU Taxonomy where they contribute to limiting climate change (“climate change mitigation”) and do not significantly harm any EU Taxonomy objective - see explanatory note in the left hand margin. The full criteria for fossil gas and nuclear energy economic activities that comply with the EU Taxonomy are laid down in Commission Delegated Regulation (EU) 2022/1214.

and among others have greenhouse gas emission levels corresponding to the best performance.



What is the minimum share of sustainable investments with an environmental objective that are not aligned with the EU Taxonomy?

Taxonomy-aligned investments are considered a sub-category of Sustainable Investments. If an investment is not Taxonomy-aligned since the activity is not yet covered under the EU Taxonomy or the positive contribution is not substantial enough to comply with the Taxonomy technical screening criteria, the investment can still be considered an environmentally Sustainable Investment provided it complies with all criteria. The Investment Manager does not commit to a minimum share of environmentally Sustainable Investments that are not aligned with the EU Taxonomy. The overall sustainable investment share may also include investments with an environmental objective in economic activities that do not qualify as environmentally sustainable under the EU Taxonomy, and while the Sub-Fund cannot commit to a minimum share of environmentally or socially sustainable investments, such investments may be freely allocated to within the Sub-Fund aggregated sustainable investment commitment disclosed (min. 50%).



are sustainable investments with an environmental objective that do not take into account the criteria for environmentally sustainable economic activities under the EU Taxonomy.



What is the minimum share of socially sustainable investments?

The Investment Manager defines Sustainable Investments based on internal research, which uses, among others, the UN Sustainable Development Goals (SDGs), as well as the objectives of the EU Taxonomy as reference frameworks. The Investment Manager does not commit to a minimum share of socially Sustainable Investments, as the SDGs contain environmental as well as social objectives. The overall sustainable investment share may also include investments with a social objective, and while the Sub-Fund cannot commit to a minimum share of environmentally or socially sustainable investments, such investments may be freely allocated to within the Sub-Fund aggregated sustainable investment commitment disclosed (min. 50%).



What investments are included under “#2 Other”, what is their purpose and are there any minimum environmental or social safeguards?

Under “#2 Other” investments into cash, Target Funds, or derivatives can be included. Derivatives might be used for efficient portfolio management (including risk hedging) and/or investment purposes, and Target Funds to benefit from a specific strategy. For those investments no environmental or social safeguards are applied.



Is a specific index designated as a reference benchmark to determine whether this financial product is aligned with the environmental and/or social characteristics that it promotes?

No reference benchmark has been designated for the purpose of attaining the environmental and/or social characteristics promoted by the Sub-Fund.

Reference benchmarks are indexes to measure whether the financial product attains the environmental or social characteristics that they promote.

- How is the reference benchmark continuously aligned with each of the environmental or social characteristics promoted by the financial product?

Not applicable

- How is the alignment of the investment strategy with the methodology of the index ensured on a continuous basis?

Not applicable

- How does the designated index differ from a relevant broad market index?
Not applicable
- Where can the methodology used for the calculation of the designated index be found?
Not applicable



Where can I find more product specific information online?

More product-specific information can be found on the website: <https://regulatory.allianzgi.com/SFDR>

Template pre-contractual disclosure for the financial products referred to in Article 8, paragraphs 1, 2 and 2a, of Regulation (EU) 2019/2088 and Article 6, first paragraph, of Regulation (EU) 2020/852

Product name:

Allianz Sustainable Multi Asset 75

Legal entity identifier: 529900A943LOFBAFNR54

Environmental and/or social characteristics

Sustainable investment means an investment in an economic activity that contributes to an environmental or social objective, provided that the investment does not significantly harm any environmental or social objective and that the investee companies follow good governance practices.

The EU Taxonomy is a classification system laid down in Regulation (EU) 2020/852, establishing a list of environmentally sustainable economic activities. That Regulation does not include a list of socially sustainable economic activities. Sustainable investments with an environmental objective might be aligned with the Taxonomy or not.

Does this financial product have a sustainable investment objective?	
Yes	No
<input type="checkbox"/> It will make a minimum of sustainable investments with an environmental objective: ___% <input type="checkbox"/> in economic activities that qualify as environmentally sustainable under the EU Taxonomy <input type="checkbox"/> in economic activities that do not qualify as environmentally sustainable under the EU Taxonomy	<input checked="" type="checkbox"/> It promotes Environmental/Social (E/S) characteristics and while it does not have as its objective a sustainable investment, it will have a minimum proportion of 20.00% of sustainable investments <input checked="" type="checkbox"/> with an environmental objective in economic activities that qualify as environmentally sustainable under the EU Taxonomy <input checked="" type="checkbox"/> with an environmental objective in economic activities that do not qualify as environmentally sustainable under the EU Taxonomy <input checked="" type="checkbox"/> with a social objective
<input type="checkbox"/> It will make a minimum of sustainable investments with a social objective ___%	<input type="checkbox"/> It promotes E/S characteristics, but will not make any sustainable investments



What environmental and/or social characteristics are promoted by this financial product?

Allianz Sustainable Multi Asset 75 (the "Sub-Fund") promotes a broad range of environmental and/or social characteristics. The Sub-Fund invests at least 70% of its assets following the "Multi Asset Sustainability Strategy" which includes, but is not limited to, various sustainability strategies of the management company and/or, invests in Green Bonds and/or Social Bonds, and/or Sustainability Bonds and/or SFDR Article 8 & 9 Target Funds ("SFDR Target Funds").

Depending on the sustainability strategy selected by the Investment Manager the promoted environmental and/or social characteristics could comprise environmental, social, human rights, governance, business behaviour factors or investments in companies providing solutions that create positive environmental and social outcomes.

In addition, sustainable minimum exclusion criteria and Sub-Fund specific exclusion criteria apply.

No reference benchmark has been designated for the purpose of attaining the environmental and/or social characteristics promoted by the Sub-Fund.

- **What sustainability indicators are used to measure the attainment of each of the environmental or social characteristics promoted by this financial product?**

As part of the Multi Asset Sustainability Strategy the Investment Manager allocates at least 70% of Fund's assets in various sustainability approaches.

Sustainability indicators measure how the environmental or social characteristics promoted by the financial product are attained.

To measure the attainment of the environmental and/or social characteristics the following sustainability indicators are used and reported on, at the fiscal year end:

- The actual percentage of the Sub-Fund's assets invested in Green Bonds, and/or Social Bonds, and/or Sustainability Bonds and/or in SFDR Target Funds and/or in Equities and/or Debt Securities in accordance with the Multi Asset Sustainability Strategy.
- In case the Investment Manager decides to directly invest in Debt or Equity Securities as part of the Multi Asset Sustainability Strategy the adherence to the respective binding element will be reported.
- Confirmation that Principal Adverse Impacts (PAIs) of investment decisions on sustainability factors are considered through the application of exclusion criteria (with exception of cash, derivatives, external Target Funds and internal Target Funds not following a sustainability strategy).

● **What are the objectives of the sustainable investments that the financial product partially intends to make and how does the sustainable investment contribute to such objectives?**

Sustainable investments contribute to environmental and/or social objectives, for which the Investment Manager uses as reference frameworks, among others, the UN Sustainable Development Goals (SDGs), as well as the objectives of the EU Taxonomy:

1. Climate Change Mitigation
2. Climate Change Adaptation
3. Sustainable Use and Protection of Water and Marine Resources
4. Transition to a Circular Economy
5. Pollution Prevention and Control
6. Protection and Restoration of Biodiversity and Ecosystems

The assessment of the positive contribution to the environmental or social objectives is based on a proprietary framework which combines quantitative elements with qualitative inputs from internal research. The methodology applies first a quantitative breakdown of a securities issuer into its business activities. The qualitative element of the framework is an assessment if business activities contribute positively to an environmental or a social objective.

To calculate the positive contribution on the Sub-Fund level the revenue share of each issuer attributable to business activities contributing to environmental and/or social objectives is considered provided the issuer is satisfying the Do No Significant Harm ("DNSH") and Good Governance principles, and an asset-weighted aggregation is performed as a second step. Moreover, for certain types of securities, which finance specific projects contributing to environmental or social objectives the overall investment is considered to contribute to environmental and/or social objectives, but also for these a DNSH as well as a Good Governance check for issuers is performed.

● **How do the sustainable investments that the financial product partially intends to make, not cause significant harm to any environmental or social sustainable investment objective?**

In order to ensure that Sustainable Investments do not significantly harm any other environmental and/or social objective, the Investment Manager is leveraging the PAI indicators, whereby significance thresholds have been defined to identify significantly harmful issuers. Issuers not meeting the significance threshold can be engaged for a limited time period to remediate the adverse impact. Otherwise, if the issuer does not meet the defined significance thresholds twice subsequently or in case of a failed engagement, it does not pass the DNSH assessment. Investments in securities of issuers which do not pass the DNSH assessment are not counted as sustainable investments.

● **How have the indicators for adverse impacts on sustainability factors been taken into account?**

All mandatory PAI indicators are considered either as part of the application of the exclusion criteria or through thresholds on a sectorial or absolute basis. Significance thresholds have been defined and they refer to qualitative or quantitative criteria.

Recognizing the lack of data coverage for some of the PAI indicators equivalent data points are used to assess PAI indicators when applying the DNSH assessment, when relevant, for the following indicators for corporates: share of non-renewable energy consumption and production, activities negatively affecting biodiversity-sensitive areas, emissions to water, lack of processes and compliance mechanisms to monitor compliance with UNGC principles and OECD Guidelines for Multinational Enterprises; for sovereigns: GHG Intensity and investee countries subject to social violations. In case of securities which

Principal adverse impacts are the most significant negative impacts of investment decisions on sustainability factors relating to environmental, social and employee matters, respect for human rights, anti-corruption and anti-bribery matters.

finance specific projects contributing to environmental or social objectives equivalent data at project level might be used to ensure that Sustainable Investments do not significantly harm any other environmental and/or social objective. The Investment Manager will strive to increase data coverage for PAI indicators with low data coverage by engaging with issuers and data providers. The Investment Manager will regularly evaluate whether the availability of data has increased sufficiently to potentially include assessment of such data in the investment process.

● *How are the sustainable investments aligned with the OECD Guidelines for Multinational Enterprises and the UN Guiding Principles on Business and Human Rights? Details:*

The Investment Manager's sustainable minimum exclusion list screens out companies based on their involvement in controversial practices against international norms. The core normative framework consists of the Principles of the UN Global Compact, the OECD Guidelines for Multinational Enterprises and the UN Guiding Principles for Business and Human Rights. Securities issued by companies having a severe violation of these frameworks will be restricted from the investment universe.

The EU Taxonomy sets out a "do not significant harm" principle by which Taxonomy-aligned investments should not significantly harm EU Taxonomy objectives and is accompanied by specific EU criteria.

The "do not significant harm" principle applies only to those investments underlying the financial product that take into account the EU criteria for environmentally sustainable economic activities. The investments underlying the remaining portion of this financial product do not take into account the EU criteria for environmentally sustainable economic activities.

Any other sustainable investments must also not significantly harm any environmental or social objectives.



Does this financial product consider principal adverse impacts on sustainability factors?

Yes

No

The Management Company has joined the Net Zero Asset Manager Initiative and considers PAI indicators through stewardship including engagement, both are relevant to mitigate potential adverse impact as a company.

Due to the commitment to the Net Zero Asset Manager Initiative, the Management Company aims to reduce greenhouse gas emissions in partnership with asset owner clients on decarbonisation goals, consistent with an ambition to reach net zero emission by 2050 or sooner across all assets under management. As part of this objective the Management Company will set an interim target for the proportion of assets to be managed in line with the attainment of net zero emissions by 2050 or sooner.

The Sub-Fund's Investment Manager addresses PAI indicators regarding greenhouse gas emission, biodiversity, water, waste as well as social and employee matters for corporate issuers, and, where relevant, the freedom house index is applied to investments in sovereigns. PAI indicators are considered within the Investment Manager's investment process through the means of exclusions as described in the "binding elements" section of the Sub-Fund.

The data coverage for the data required for the PAI indicators is heterogenous. The data coverage related to biodiversity, water and waste is low and the related PAI indicators are considered through exclusion of securities issued by companies having a severe violation / breach of principles and guidelines such as the Principles of the United Nations Global Compact, the OECD Guidelines for Multinational Enterprises, and the United Nations Guiding Principles for Business and Human Rights on the grounds of problematic practices around human rights, labour rights, environment, and corruption issues. Therefore, the Investment Manager will strive to increase data coverage for PAI indicators with low data coverage. The Investment Manager will regularly evaluate whether the availability of data has increased sufficiently to potentially include assessment of such data in the investment process.

The following PAI indicators are considered:

Applicable to corporate issuers

- GHG Emissions
- Carbon footprint
- GHG Intensity of investee companies
- Exposure to companies active in the fossil fuel sector

- Activities negatively affecting biodiversity-sensitive areas
- Emissions to water
- Hazardous waste ratio
- Violation of UN Global compact principles
- Lack of processes and compliance mechanisms to monitor compliance with UN Global Compact principles
- Board gender diversity
- Exposure to controversial weapons

Applicable to sovereign and supranational issuers

- Investee countries subject to social violations

The information on the PAI indicators will be available in the end-year report of the Sub-Fund.



What investment strategy does this financial product follow?

The investment strategy guides investment decisions based on factors such as investment objectives and risk tolerance.

Allianz Sustainable Multi Asset 75's investment objective is to invest in a broad range of asset classes, with a focus on global Equity, Bond, and Money Markets in order to achieve over the medium-term a performance comparable to a balanced portfolio within a volatility range of 10% to 16% in accordance with the Multi Asset Sustainability Investment Strategy. The assessment of the volatility of the capital markets by the Investment Manager is an important factor in this process, with the aim of typically not falling below or exceeding a volatility of the share price within a range of 10% to 16% on a medium to long-term average, similar to a portfolio consisting of 75% global Equity Markets and 25% Euro denominated Bond Markets. A Sub-Fund managed according to the Multi Asset Sustainability Strategy ("MAS Strategy") invests in (i) Equities and / or Debt Securities of companies that either provide for environmental and/or social characteristics and/or pursue activities contributing to an environmental or social objective and / or invests (ii) in Green Bonds and/or Social Bonds, and/or in Sustainability Bonds and/or (iii) in SFDR Target Funds.

In case of direct investments in Equities and/or Debt Securities, the Sub-Fund's Investment Manager may choose one or more of the below strategies that promote environmental and/or social characteristics and/or pursue activities contributing to an environmental or social objective:

- SRI Strategy

The Sub-Fund or strategy promotes environmental and social characteristics through integrating environmental, social, human rights, governance and business behaviour factors into the Sub-Fund's investment process through a best-in-class approach. This encompasses the evaluation of corporate or sovereign issuers based on an SRI Rating that it is used to construct the portfolio.

- Climate Engagement with Outcome Strategy

The Sub-Fund or strategy promotes environmental characteristics through the engagement with the top 10 carbon emitting issuers to encourage their transition pathway to a low carbon economy by setting objectives which are sector specific.

- SDG-Aligned & SDG-Aligned Type A Strategy

The Sub-Fund's or strategy's Sustainable Investment objective is to invest in Equities and/or in Debt Securities of companies providing solutions that create positive environmental and social outcomes, as assessed by the contribution of companies' outputs to the attainment of one or more of the SDGs or other Sustainable Investment objectives, which the Sub-Fund's Investment Manager may additionally determine and to which the companies contribute to.

- Green Bond Strategy

The Sub-Fund's or strategy's Sustainable Investment objective is to mobilize capital markets towards the transition to a low carbon society, natural capital preservation and adaptation to climate change. The Sub-Fund or strategy invests primarily in Green Bonds financing climate change mitigation or adaptation projects or other environmental sustainability projects, notably in the following fields: energy efficiency, renewable energy, raw materials, water and land, waste management, greenhouse gas emissions reduction, biodiversity preservation or circular economy.

- Green Transition Strategy

The Sub-Fund or strategy promotes environmental and/or social characteristics through the mobilization of capital markets towards the transition to a low carbon society, natural capital preservation and adaptation to climate change.

- KPI Strategy (Absolute)

A Sub-Fund or strategy managed according to the Sustainability Key Performance Indicator Strategy (Absolute) ("KPI Strategy (Absolute)") promotes environmental objectives by applying an investment objective related to an environmental key performance indicator referred to as "Sustainability KPI" to provide transparency on the measurable sustainability outcome pursued. The "Sustainability KPI" to be measured is the GHG Intensity defined by the Weighted Average GHG Intensity (Sales) of issuers included in the Fund's portfolio. GHG Intensity will be addressed by ensuring a pre-determined year-on-year improvement pathway of the weighted average GHG Intensity on Fund's portfolio level at the Fund's fiscal year ends.

- KPI Strategy (Relative)

A Sub-Fund or strategy managed according to the Sustainability Key Performance Indicator Strategy (Relative) ("KPI Strategy (Relative)") promotes environmental objectives by applying an investment objective related to an environmental key performance indicator referred to as "Sustainability KPI" to provide transparency on the measurable sustainability outcome pursued. The "Sustainability KPI" to be measured is the GHG Intensity of issuers acquired by the Fund defined by the Weighted Average GHG Intensity (Sales). GHG Intensity of the Fund will be addressed by outperforming the Fund's benchmark (respectively the Weighted Average GHG Intensity of the issuers included in the Fund's benchmark) in terms of Weighted Average GHG Intensity.

- ESG Score Strategy

A Sub-Fund or strategy managed according to the ESG Score Strategy promotes Environment, Social and Governance factors through the ESG Score Strategy. The ESG Score Strategy aims to measure a company's resilience to long-term risks across the three pillars of Environment, Social and Governance. ESG pillars will be addressed by outperforming the Weighted Average ESG Score of issuers whose shares have been acquired by the Fund against the Weighted Average ESG Score of issuers which are components of Fund's benchmark.

- KPI Strategy (Absolute Threshold)

A Sub-Fund or strategy managed according to the Sustainability Key Performance Indicator Strategy (Absolute Threshold) ("KPI Strategy (Absolute Threshold)") targets a specific minimum allocation into Sustainable Investments. Sustainable investments are investments in economic activities which contribute to environmental and/or social objectives, for which the Investment Managers uses as reference frameworks the UN Sustainable Development Goals (SDGs), as well as the objectives of the EU Taxonomy.

The Sub-Fund's general investment approach (Sub-Fund's applicable General Asset Class Principles in combination with its individual investment restrictions) is described in the prospectus.

● **What are the binding elements of the investment strategy used to select the investments to attain each of the environmental or social characteristics promoted by this financial product?**

A Sub-Fund managed according to the Multi Asset Sustainability Strategy ("MAS Strategy") invests in (i) Equities and / or Debt Securities of companies that either provide for environmental and/or social characteristics and/or pursue activities contributing to an environmental or social objective and / or invests (ii) in Green Bonds and/or Social Bonds, and/or in Sustainability Bonds and/or (iii) in SFDR Target Funds.

Overall, the Investment Manager is required to invest min 70% of Sub-Fund's assets in SFDR Target Funds and/or in Equities and/or Debt Securities in accordance with the Multi Asset Sustainability Strategy.

The following sustainable minimum exclusion criteria for direct investments apply:

- securities issued by companies having a severe violation / breach of principles and guidelines such as the Principles of the United Nations Global Compact, the OECD Guidelines for Multinational Enterprises, and the United Nations Guiding Principles for Business and Human Rights on the grounds of problematic practices around human rights, labour rights, environment, and corruption issues,
- securities issued by companies involved in controversial weapons (anti-personnel mines, cluster munitions, chemical weapons, biological weapons, depleted uranium, white phosphorus, and nuclear weapons),
- securities issued by companies that derive more than 10% of their revenues from weapons, military equipment, and services,
- securities issued by companies that derive more than 10% of their revenue from thermal coal extraction,

- securities issued by utility companies that generate more than 20% of their revenues from coal,
- securities issued by companies involved in the production of tobacco, and securities issued by companies involved in the distribution of tobacco with more than 5% of their revenues.

The following Sub-Fund specific exclusion criteria for direct investments apply:

- Sub-fund assets may not be invested in securities of (corporate and sovereign) issuers of Lebanon, Saint Barthelemy and Ukraine
- Sub-Fund assets may not be invested in securities issued by companies that are active in the palm oil industry and less than 50% of the respective company's revenue in palm oil is certified by RSPO (Roundtable on Sustainable Palm Oil)
- Sub-Fund assets may not be invested in securities issued by companies which are involved in the production of gambling and/or which are involved in the distribution/sales of gambling and/or which provide services in relation to gambling of more than 10% of their revenues
- Sub-Fund assets may not be invested in securities issued by companies that derive more than 10% of their revenues from unconventional oil & gas extraction
- Sub-Fund assets may not be invested in securities issued by conventional oil and gas producing companies that generate less than 40% of their revenues from natural gas and or renewable energy.
- Sub-Fund assets may not be invested in securities issued by electricity generating companies with a carbon intensity above the threshold set by the Climate Paris Agreement or, if carbon intensity is not available, no more than 10% of their electricity production is based on coal and/or no more than 30% of electricity production is based on oil and gas and/or no more than 30% of their electricity production is based on nuclear energy.

Direct investments in sovereign issuers with an insufficient freedom house index score are excluded.

The sustainable minimum exclusion criteria, as well as the Sub-Fund specific exclusion criteria, are based on information from an external data provider and coded in pre- and post-trade compliance. The review is performed at least half yearly.

● **What is the committed minimum rate to reduce the scope of the investments considered prior to the application of that investment strategy?**

The Sub-Fund does not commit to reduce the scope of the investments by a certain minimum rate.

● **What is the policy to assess good governance practices of the investee companies?**

Good governance principles are considered by screening out companies based on their involvement in controversies around international norms corresponding to the four good governance practices: sound management structures, employee relations, remuneration of staff and tax compliance. Companies having a severe violation in either of those areas will not be investible. For certain cases, flagged issuers shall be on a watch list. These companies will appear on this watch list when the Investment Manager believes that engagement may lead to improvements or when the company is assessed to take remedial actions. Companies on the watch list remain investible unless the Investment Manager believes that the engagement or the remedial actions of the company does not lead to the desired remedy of the severe controversy.

In addition, the Sub-Fund's Investment Manager is committed to actively encourage open dialogues with investee companies on corporate governance, proxy voting and broader sustainability issues in advance of shareholder meetings (regularly for direct investments in shares). The Sub-Fund's Investment Manager's approach to proxy voting and company engagement is set out in the Management Company's Stewardship Statement.

What is the asset allocation planned for this financial product?

Min. 70% of the Sub-Funds' assets are used to meet the environmental or social characteristics promoted by this Sub-Fund. A low portion of the Sub-Fund might contain assets which do not promote environmental or social characteristics. Example of such instruments are derivatives, cash and deposits, some Target Funds and investment with temporarily divergent or absent environmental, social, or good governance qualifications or investments outside of the specified quota to be invested as part of the Multi Asset Sustainability Strategy. Min. 20% of the Sub-Funds' assets will be invested in Sustainable Investments. The minimum percentage of investments that are aligned with the EU Taxonomy is 0.01%. The Sub-Fund's Investment Manager does not

Good governance practices include sound management structures, employee relations, remuneration of staff and tax compliance.



Asset allocation describes the share of investments in specific assets.

commit to a minimum share of environmentally Sustainable Investments that are not aligned with the EU Taxonomy. The Sub-Fund's Investment Manager does not commit to a minimum share of socially sustainable investments. While the Sub-Fund cannot commit to a minimum share of environmentally or socially sustainable investments, such investments may be freely allocated to within the Sub-Fund aggregated sustainable investment commitment disclosed (min. 20%).

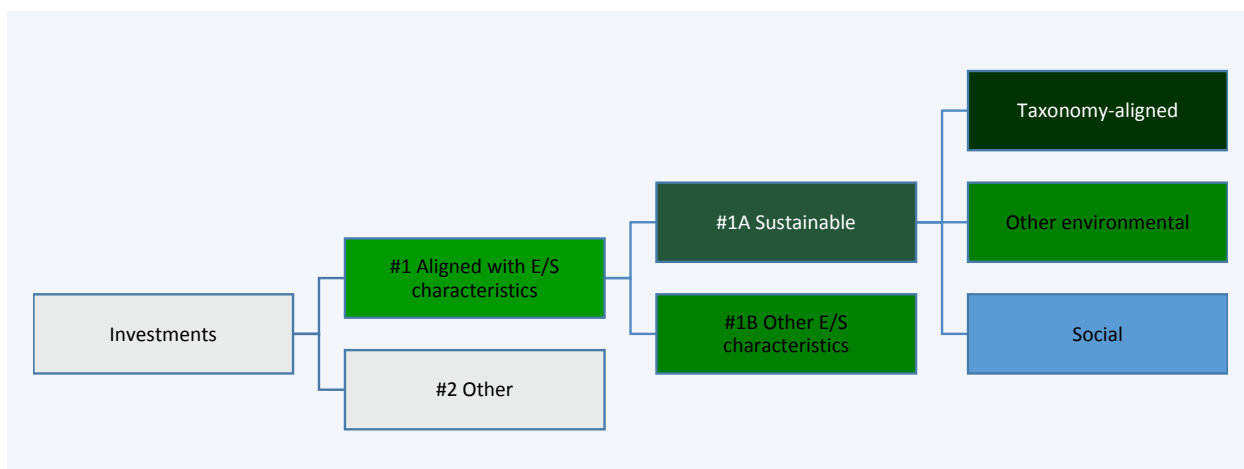

#1 Aligned with E/S characteristics includes the investments of the financial product used to attain the environmental or social characteristics promoted by the financial product.

#2 Other includes the remaining investments of the financial product which are neither aligned with the environmental or social characteristics, nor are qualified as sustainable investments.

The category **#1 Aligned with E/S characteristics** covers:

- The sub-category **#1A Sustainable** covers sustainable investments with environmental or social objectives.
- The sub-category **#1B Other E/S characteristics** covers investments aligned with the environmental or social characteristics that do not qualify as sustainable investments.

● **How does the use of derivatives attain the environmental or social characteristics promoted by the financial product?**

Not applicable



To what minimum extent are sustainable investments with an environmental objective aligned with the EU Taxonomy?

The Taxonomy-aligned investments include debt and/or equity in environmentally sustainable economic activities aligned with the EU-Taxonomy. The minimum percentage of investments that are aligned with the EU Taxonomy is 0.01%. Taxonomy-aligned data is provided by an external data provider. The Investment Manager has assessed the quality of such data. The data will not be subject to an assurance provided by auditors or a review by third parties. The data will not reflect any data in government bonds. As of today, there is no recognized methodology available to determine the proportion of Taxonomy-aligned activities when investing in government bonds.

Taxonomy-aligned activities in this disclosure are based on share of turnover. Pre-contractual figures use turnover as its financial metric as a default in line with the regulatory requirements and based on the fact that complete, verifiable or up-to date data for CAPEX and/or OPEX as financial metric is even less available.

Taxonomy-aligned data is only in rare cases data reported by companies in accordance with the EU Taxonomy. The data provider has derived Taxonomy-aligned data from other available equivalent public data.

● **Does the financial product invest in fossil gas and/or nuclear energy related activities that comply with the EU Taxonomy¹?**

Yes:

In fossil gas In nuclear energy

Taxonomy-aligned activities are expressed as a share of:
- turnover reflecting the share of revenue from green activities of

¹ Fossil gas and/or nuclear related activities will only comply with the EU Taxonomy where they contribute to limiting climate change ("climate change mitigation") and do not significantly harm any EU Taxonomy objective - see explanatory note in the left hand margin. The full criteria for fossil gas and nuclear energy economic activities that comply with the EU Taxonomy are laid down in Commission Delegated Regulation (EU) 2022/1214.

No

The Sub-Fund does not pursue any investments in fossil gas and/or nuclear energy related activities that comply with the EU Taxonomy. Nevertheless, as result of this investment strategy, investments may occur in corporates which are also active in these activities. Further information will be provided as part of the annual reporting, if relevant.

The two graphs below show in green the minimum percentage of investments that are aligned with the EU Taxonomy. As there is no appropriate methodology to determine the Taxonomy-alignment of sovereign bonds*, the first graph shows the Taxonomy-alignment in relation to all the investments of the financial product including sovereign bonds, while the second graph shows the Taxonomy-alignment only in relation to the investments of the financial product other than sovereign bonds.

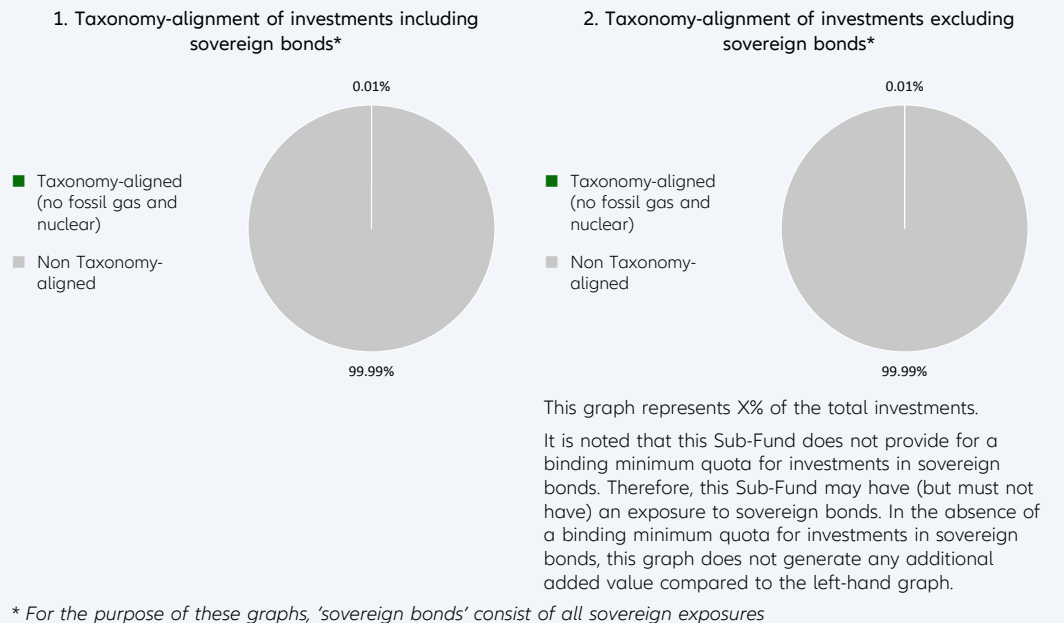

● **What is the minimum share of investments in transitional and enabling activities?**

The Sub-Fund's Investment Manager does not commit to a split of minimum taxonomy alignment into transitional, enabling activities and own performance.

 **What is the minimum share of sustainable investments with an environmental objective that are not aligned with the EU Taxonomy?**

Taxonomy-aligned investments are considered a sub-category of Sustainable Investments. If an investment is not Taxonomy-aligned since the activity is not yet covered under the EU Taxonomy or the positive contribution is not substantial enough to comply with the Taxonomy technical screening criteria, the investment can still be considered an environmentally Sustainable Investment provided it complies with all criteria. The Investment Manager does not commit to a minimum share of environmentally Sustainable Investments that are not aligned with the EU Taxonomy. The overall sustainable investment share may also include investments with an environmental objective in economic activities that do not qualify as environmentally sustainable under the EU Taxonomy, and while the Sub-Fund cannot commit to a minimum share of environmentally or socially sustainable

investee companies
 - **capital expenditure** (CapEx) showing the green investments made by investee companies, e.g. for a transition to a green economy.
 - **operational expenditure** (OpEx) reflecting green operational activities of investee companies.

Enabling activities directly enable other activities to make a substantial contribution to an environmental objective.

Transitional activities are activities for which low-carbon alternatives are not yet available and among others have greenhouse gas emission levels corresponding to the best performance.

 are sustainable investments with an environmental objective that **do not take into account the criteria** for environmentally sustainable economic activities under the EU Taxonomy.

investments, such investments may be freely allocated to within the Sub-Fund aggregated sustainable investment commitment disclosed (min. 20%).



What is the minimum share of socially sustainable investments?

The Investment Manager defines Sustainable Investments based on internal research, which uses, among others, the UN Sustainable Development Goals (SDGs), as well as the objectives of the EU Taxonomy as reference frameworks. The Investment Manager does not commit to a minimum share of socially Sustainable Investments, as the SDGs contain environmental as well as social objectives. The overall sustainable investment share may also include investments with a social objective, and while the Sub-Fund cannot commit to a minimum share of environmentally or socially sustainable investments, such investments may be freely allocated to within the Sub-Fund aggregated sustainable investment commitment disclosed (min. 20%).



What investments are included under “#2 Other”, what is their purpose and are there any minimum environmental or social safeguards?

Under “#2 Other” investments into cash, Target Funds, or derivatives can be included. Derivatives might be used for efficient portfolio management (including risk hedging) and/or investment purposes, and Target Funds to benefit from a specific strategy. For those investments no environmental or social safeguards are applied.



Is a specific index designated as a reference benchmark to determine whether this financial product is aligned with the environmental and/or social characteristics that it promotes?

No reference benchmark has been designated for the purpose of attaining the environmental and/or social characteristics promoted by the Sub-Fund.

Reference benchmarks are indexes to measure whether the financial product attains the environmental or social characteristics that they promote.

- **How is the reference benchmark continuously aligned with each of the environmental or social characteristics promoted by the financial product?**
Not applicable
- **How is the alignment of the investment strategy with the methodology of the index ensured on a continuous basis?**
Not applicable
- **How does the designated index differ from a relevant broad market index?**
Not applicable
- **Where can the methodology used for the calculation of the designated index be found?**
Not applicable



Where can I find more product specific information online?

More product-specific information can be found on the website: <https://regulatory.allianzgi.com/SFDR>

Template pre-contractual disclosure for the financial products referred to in Article 8, paragraphs 1, 2 and 2a, of Regulation (EU) 2019/2088 and Article 6, first paragraph, of Regulation (EU) 2020/852

Product name:

Allianz Systematic Enhanced US Equity SRI

Legal entity identifier: 5299002WOGP7C2R2FD60

Environmental and/or social characteristics

Sustainable investment means an investment in an economic activity that contributes to an environmental or social objective, provided that the investment does not significantly harm any environmental or social objective and that the investee companies follow good governance practices.

The **EU Taxonomy** is a classification system laid down in Regulation (EU) 2020/852, establishing a list of **environmentally sustainable economic activities**. That Regulation does not include a list of socially sustainable economic activities. Sustainable investments with an environmental objective might be aligned with the Taxonomy or not.

Does this financial product have a sustainable investment objective?	
<input checked="" type="radio"/> <input checked="" type="radio"/> Yes	<input checked="" type="radio"/> <input type="radio"/> No
<input type="checkbox"/> It will make a minimum of sustainable investments with an environmental objective: ___% <ul style="list-style-type: none"> <input type="checkbox"/> in economic activities that qualify as environmentally sustainable under the EU Taxonomy <input type="checkbox"/> in economic activities that do not qualify as environmentally sustainable under the EU Taxonomy 	<input checked="" type="checkbox"/> It promotes Environmental/Social (E/S) characteristics and while it does not have as its objective a sustainable investment, it will have a minimum proportion of 20.00% of sustainable investments <ul style="list-style-type: none"> <input checked="" type="checkbox"/> with an environmental objective in economic activities that qualify as environmentally sustainable under the EU Taxonomy <input checked="" type="checkbox"/> with an environmental objective in economic activities that do not qualify as environmentally sustainable under the EU Taxonomy <input checked="" type="checkbox"/> with a social objective
<input type="checkbox"/> It will make a minimum of sustainable investments with a social objective ___%	<input type="checkbox"/> It promotes E/S characteristics, but will not make any sustainable investments



What environmental and/or social characteristics are promoted by this financial product?

Allianz Systematic Enhanced US Equity SRI (the "Sub-Fund") promotes environmental, social, human rights, governance, and business behaviour factors (this domain does not apply for sovereigns issued by a Sovereign Entity) through integration of a best-in-class approach into the Sub-Fund's investment process. This encompasses the evaluation of corporate or sovereign issuers based on an SRI Rating which is used to construct the portfolio.

In addition, sustainable minimum exclusion criteria apply.

A reference benchmark has been designated for the purpose of attaining the environmental and/or social characteristics promoted by the Sub-Fund.

● What sustainability indicators are used to measure the attainment of each of the environmental or social characteristics promoted by this financial product?

To measure the attainment of the environmental and/or social characteristics the following sustainability indicators are used and reported on, at the fiscal year end:

- The actual percentage of the Sub-Fund's Portfolio (Portfolio in this respect does not comprise non-rated derivatives and instruments that are non-rated by nature (e. g., cash and deposits)) assets invested in best-in-class issuers (issuers with a minimum SRI Rating of 1 out of a scale from 0-4; 0 being the worst rating and 4 the best rating) is compared to the actual percentage of the benchmarks best-in-class issuers.
- Adherence to a 20% reduction of the investment universe

Sustainability indicators measure how the environmental or social characteristics promoted by the financial product are attained.

- Confirmation that Principal Adverse Impacts (PAIs) of investment decisions on sustainability factors are considered through the application of exclusion criteria.

- **What are the objectives of the sustainable investments that the financial product partially intends to make and how does the sustainable investment contribute to such objectives?**

Sustainable investments contribute to environmental and/or social objectives, for which the Investment Manager uses as reference frameworks, among others, the UN Sustainable Development Goals (SDGs), as well as the objectives of the EU Taxonomy:

1. Climate Change Mitigation
2. Climate Change Adaptation
3. Sustainable Use and Protection of Water and Marine Resources
4. Transition to a Circular Economy
5. Pollution Prevention and Control
6. Protection and Restoration of Biodiversity and Ecosystems

The assessment of the positive contribution to the environmental or social objectives is based on a proprietary framework which combines quantitative elements with qualitative inputs from internal research. The methodology applies first a quantitative breakdown of a securities issuer into its business activities. The qualitative element of the framework is an assessment if business activities contribute positively to an environmental or a social objective.

To calculate the positive contribution on the Sub-Fund level the revenue share of each issuer attributable to business activities contributing to environmental and/or social objectives is considered provided the issuer is satisfying the Do No Significant Harm (“DNSH”) and Good Governance principles, and an asset-weighted aggregation is performed as a second step. Moreover, for certain types of securities, which finance specific projects contributing to environmental or social objectives the overall investment is considered to contribute to environmental and/or social objectives, but also for these a DNSH as well as a Good Governance check for issuers is performed.

- **How do the sustainable investments that the financial product partially intends to make, not cause significant harm to any environmental or social sustainable investment objective?**

In order to ensure that Sustainable Investments do not significantly harm any other environmental and/or social objective, the Investment Manager is leveraging the PAI indicators, whereby significance thresholds have been defined to identify significantly harmful issuers. Issuers not meeting the significance threshold can be engaged for a limited time period to remediate the adverse impact. Otherwise, if the issuer does not meet the defined significance thresholds twice subsequently or in case of a failed engagement, it does not pass the DNSH assessment. Investments in securities of issuers which do not pass the DNSH assessment are not counted as sustainable investments.

- *How have the indicators for adverse impacts on sustainability factors been taken into account?*

All mandatory PAI indicators are considered either as part of the application of the exclusion criteria or through thresholds on a sectorial or absolute basis. Significance thresholds have been defined and they refer to qualitative or quantitative criteria.

Recognizing the lack of data coverage for some of the PAI indicators equivalent data points are used to assess PAI indicators when applying the DNSH assessment, when relevant, for the following indicators for corporates: share of non-renewable energy consumption and production, activities negatively affecting biodiversity-sensitive areas, emissions to water, lack of processes and compliance mechanisms to monitor compliance with UNGC principles and OECD Guidelines for Multinational Enterprises; for sovereigns: GHG Intensity and investee countries subject to social violations. In case of securities which finance specific projects contributing to environmental or social objectives equivalent data at project level might be used to ensure that Sustainable Investments do not significantly harm any other environmental and/or social objective. The Investment Manager will strive to increase data coverage for PAI indicators with low data coverage by engaging with issuers and data providers. The Investment Manager will regularly evaluate whether the availability of data has increased sufficiently to potentially include assessment of such data in the investment process.

Principal adverse impacts are the most significant negative impacts of investment decisions on sustainability factors relating to environmental, social and employee matters, respect for human rights, anti-corruption and anti-bribery matters.

- *How are the sustainable investments aligned with the OECD Guidelines for Multinational Enterprises and the UN Guiding Principles on Business and Human Rights? Details:*

The Investment Manager's sustainable minimum exclusion list screens out companies based on their involvement in controversial practices against international norms. The core normative framework consists of the Principles of the UN Global Compact, the OECD Guidelines for Multinational Enterprises and the UN Guiding Principles for Business and Human Rights. Securities issued by companies having a severe violation of these frameworks will be restricted from the investment universe.

The EU Taxonomy sets out a "do not significant harm" principle by which Taxonomy-aligned investments should not significantly harm EU Taxonomy objectives and is accompanied by specific EU criteria.

The "do not significant harm" principle applies only to those investments underlying the financial product that take into account the EU criteria for environmentally sustainable economic activities. The investments underlying the remaining portion of this financial product do not take into account the EU criteria for environmentally sustainable economic activities.

Any other sustainable investments must also not significantly harm any environmental or social objectives.



Does this financial product consider principal adverse impacts on sustainability factors?

Yes

No

The Management Company has joined the Net Zero Asset Manager Initiative and considers PAI indicators through stewardship including engagement, both are relevant to mitigate potential adverse impact as a company.

Due to the commitment to the Net Zero Asset Manager Initiative, the Management Company aims to reduce greenhouse gas emissions in partnership with asset owner clients on decarbonisation goals, consistent with an ambition to reach net zero emission by 2050 or sooner across all assets under management. As part of this objective the Management Company will set an interim target for the proportion of assets to be managed in line with the attainment of net zero emissions by 2050 or sooner.

The Sub-Fund's Investment Manager considers PAI indicators regarding greenhouse gas emission, biodiversity, water, waste as well as social and employee matters for corporate issuers, and, where relevant, the freedom house index is applied to investments in sovereigns. PAI indicators are considered within the Investment Manager's investment process through the means of exclusions as described in the "binding elements" section of the Sub-Fund.

The data coverage for the data required for the PAI indicators is heterogenous. The data coverage related to biodiversity, water and waste is low and the related PAI indicators are considered through exclusion of securities issued by companies having a severe violation / breach of principles and guidelines such as the Principles of the United Nations Global Compact, the OECD Guidelines for Multinational Enterprises, and the United Nations Guiding Principles for Business and Human Rights on the grounds of problematic practices around human rights, labour rights, environment, and corruption issues. Therefore, the Investment Manager will strive to increase data coverage for PAI indicators with low data coverage. The Investment Manager will regularly evaluate whether the availability of data has increased sufficiently to potentially include assessment of such data in the investment process.

Additionally, PAI indicators are, among other sustainability factors, applied to derive the SRI Rating. The SRI Rating is used for the portfolio construction.

The following PAI indicators are considered:

Applicable to corporate issuers

- GHG Emissions
- Carbon footprint
- GHG Intensity of investee companies
- Exposure to companies active in the fossil fuel sector
- Activities negatively affecting biodiversity-sensitive areas
- Emissions to water
- Hazardous waste ratio

- Violation of UN Global compact principles
- Lack of processes and compliance mechanisms to monitor compliance with UN Global Compact principles
- Board gender diversity
- Exposure to controversial weapons

Applicable to sovereign and supranational issuers

- Investee countries subject to social violations

The information on the PAI indicators will be available in the end-year report of the Sub-Fund.



The investment strategy guides investment decisions based on factors such as investment objectives and risk tolerance.

What investment strategy does this financial product follow?

Allianz Systematic Enhanced US Equity SRI's investment objective is to invest in US Equity Markets in accordance with the Sustainable and Responsible Investment Strategy (SRI Strategy). The Investment Manager may engage in foreign currency overlay and thus assume separate foreign currency risks with regard to currencies of OECD member states, even if the Sub-Fund does not include any assets denominated in these respective currencies.

As part of the SRI best-in-class approach, the Sub-Fund takes environmental, social, human rights, governance, and business behaviour factors into account as follows:

- The aforesaid sustainability factors are analysed through SRI Research by the Investment Manager in order to assess how sustainable development and long-term issues are taken into account in the strategy of an issuer. SRI Research means the overall process of identifying potential risks as well as potential opportunities of an investment in securities of an issuer related to the analysis of sustainability factors. SRI Research data combines external research data (which might have some limitations) with internal analyses.
- Based on a combination of the results of the external and/or internal analyses of the sustainability factors, an internal rating is derived monthly (SRI Rating) and is afterwards assigned to a corporate or sovereign issuer.

This internal SRI Rating is used to rank and select or weight securities for the portfolio construction.

The Sub-Fund's general investment approach (Sub-Fund's applicable General Asset Class Principles in combination with its individual investment restrictions) is described in the prospectus.

● What are the binding elements of the investment strategy used to select the investments to attain each of the environmental or social characteristics promoted by this financial product?

The binding elements are:

- Minimum rating coverage: At least 90% of the Sub-Fund's portfolio is required to have an SRI Rating (portfolio in this respect does not comprise non-rated derivatives and instruments that are non-rated by nature e.g., cash and deposits). While most holdings of the Sub-Fund will have a corresponding SRI Rating some investments cannot be rated according to the SRI Research methodology. Examples of instruments not attaining to the SRI Rating include, but are not limited to cash, deposits, Target Funds, and non-rated investments.
- 80% of the rated instruments are adhering to the minimum rating threshold of 1 (out of a rating scale from 0 – 4; 0 being the worst rating and 4 the best rating).
- Reduction of investment universe by excluding at least 20% of issuers.
- Application of the following sustainable minimum exclusion criteria for direct investments:
 - securities issued by companies having a severe violation / breach of principles and guidelines such as the Principles of the United Nations Global Compact, the OECD Guidelines for Multinational Enterprises, and the United Nations Guiding Principles for Business and Human Rights on the grounds of problematic practices around human rights, labour rights, environment, and corruption issues,
 - securities issued by companies involved in controversial weapons (anti-personnel mines, cluster munitions, chemical weapons, biological weapons, depleted uranium, white phosphorus, and nuclear weapons),
 - securities issued by companies that derive more than 10% of their revenues from weapons, military equipment, and services,

- securities issued by companies that derive more than 10% of their revenue from thermal coal extraction,
- securities issued by utility companies that generate more than 20% of their revenues from coal,
- securities issued by companies involved in the production of tobacco, and securities issued by companies involved in the distribution of tobacco with more than 5% of their revenues.

Direct investments in sovereign issuers with an insufficient freedom house index score are excluded.

The sustainable minimum exclusion criteria are based on information from an external data provider and coded in pre- and post-trade compliance. The review is performed at least half yearly.

● **What is the committed minimum rate to reduce the scope of the investments considered prior to the application of that investment strategy?**

The Sub-Fund commits to reduce the investment universe by at least 20%.

● **What is the policy to assess good governance practices of the investee companies?**

Good governance principles are considered by screening out companies based on their involvement in controversies around international norms corresponding to the four good governance practices: sound management structures, employee relations, remuneration of staff and tax compliance. Companies having a severe violation in either of those areas will not be investible. For certain cases, flagged issuers shall be on a watch list. These companies will appear on this watch list when the Investment Manager believes that engagement may lead to improvements or when the company is assessed to take remedial actions. Companies on the watch list remain investible unless the Investment Manager believes that the engagement or the remedial actions of the company does not lead to the desired remedy of the severe controversy.

In addition, the Sub-Fund's Investment Manager is committed to actively encourage open dialogues with investee companies on corporate governance, proxy voting and broader sustainability issues in advance of shareholder meetings (regularly for direct investments in shares). The Sub-Fund's Investment Manager's approach to proxy voting and company engagement is set out in the Management Company's Stewardship Statement.

Good governance practices include sound management structures, employee relations, remuneration of staff and tax compliance.



What is the asset allocation planned for this financial product?

Asset allocation describes the share of investments in specific assets.

Min. 90% of the Sub-Funds' assets (excluding cash and non-rated derivatives) are used to meet the environmental or social characteristics promoted by this Sub-Fund. A low portion of the Sub-Fund might contain assets which do not promote environmental or social characteristics. Examples of such instruments are derivatives, cash and deposits, some Target Funds and investment with temporarily divergent or absent environmental, social, or good governance qualifications. Min. 20% of the Sub-Funds' assets will be invested in Sustainable Investments. The minimum percentage of investments that are aligned with the EU Taxonomy is 0.01%. The Sub-Fund's Investment Manager does not commit to a minimum share of environmentally Sustainable Investments that are not aligned with the EU Taxonomy. The Sub-Fund's Investment Manager does not commit to a minimum share of socially sustainable investments. While the Sub-Fund cannot commit to a minimum share of environmentally or socially sustainable investments, such investments may be freely allocated to within the Sub-Fund aggregated sustainable investment commitment disclosed (min. 20%).

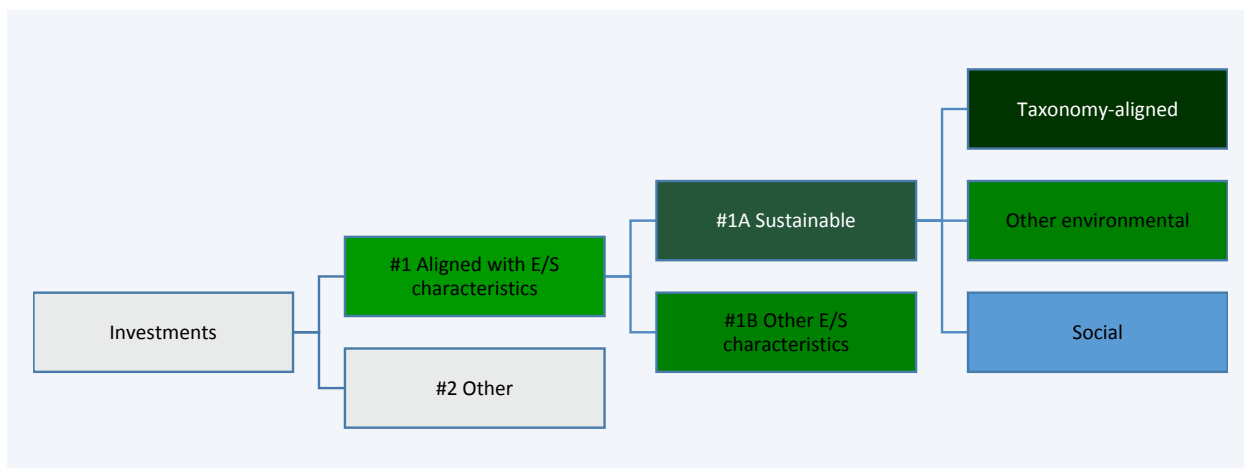

#1 Aligned with E/S characteristics includes the investments of the financial product used to attain the environmental or social characteristics promoted by the financial product.

#2 Other includes the remaining investments of the financial product which are neither aligned with the environmental or social characteristics, nor are qualified as sustainable investments.

The category **#1 Aligned with E/S characteristics** covers:

- The sub-category **#1A Sustainable** covers sustainable investments with environmental or social objectives.
- The sub-category **#1B Other E/S characteristics** covers investments aligned with the environmental or social characteristics that do not qualify as sustainable investments.

● **How does the use of derivatives attain the environmental or social characteristics promoted by the financial product?**

Not applicable



To what minimum extent are sustainable investments with an environmental objective aligned with the EU Taxonomy?

The Taxonomy-aligned investments include debt and/or equity in environmentally sustainable economic activities aligned with the EU-Taxonomy. The minimum percentage of investments that are aligned with the EU Taxonomy is 0.01%. Taxonomy-aligned data is provided by an external data provider. The Investment Manager has assessed the quality of such data. The data will not be subject to an assurance provided by auditors or a review by third parties. The data will not reflect any data in government bonds. As of today, there is no recognized methodology available to determine the proportion of Taxonomy-aligned activities when investing in government bonds.

Taxonomy-aligned activities in this disclosure are based on share of turnover. Pre-contractual figures use turnover as its financial metric as a default in line with the regulatory requirements and based on the fact that complete, verifiable or up-to date data for CAPEX and/or OPEX as financial metric is even less available.

Taxonomy-aligned data is only in rare cases data reported by companies in accordance with the EU Taxonomy. The data provider has derived Taxonomy-aligned data from other available equivalent public data.

● **Does the financial product invest in fossil gas and/or nuclear energy related activities that comply with the EU Taxonomy ¹?**

- Yes:
 - In fossil gas
 - In nuclear energy
- No

The Sub-Fund does not pursue any investments in fossil gas and/or nuclear energy related activities that comply with the EU Taxonomy. Nevertheless, as result of this investment strategy, investments may occur in corporates which are also active in these activities. Further information will be provided as part of the annual reporting, if relevant.

Taxonomy-aligned activities are expressed as a share of:
 - **turnover** reflecting the share of revenue from green activities of investee companies
 - **capital expenditure (CapEx)** showing the green investments made by investee companies, e.g. for a transition to a green

¹ Fossil gas and/or nuclear related activities will only comply with the EU Taxonomy where they contribute to limiting climate change ("climate change mitigation") and do not significantly harm any EU Taxonomy objective - see explanatory note in the left hand margin. The full criteria for fossil gas and nuclear energy economic activities that comply with the EU Taxonomy are laid down in Commission Delegated Regulation (EU) 2022/1214.

economy.
 - **operational expenditure** (OpEx) reflecting green operational activities of investee companies.

The two graphs below show in green the minimum percentage of investments that are aligned with the EU Taxonomy. As there is no appropriate methodology to determine the Taxonomy-alignment of sovereign bonds*, the first graph shows the Taxonomy-alignment in relation to all the investments of the financial product including sovereign bonds, while the second graph shows the Taxonomy-alignment only in relation to the investments of the financial product other than sovereign bonds.

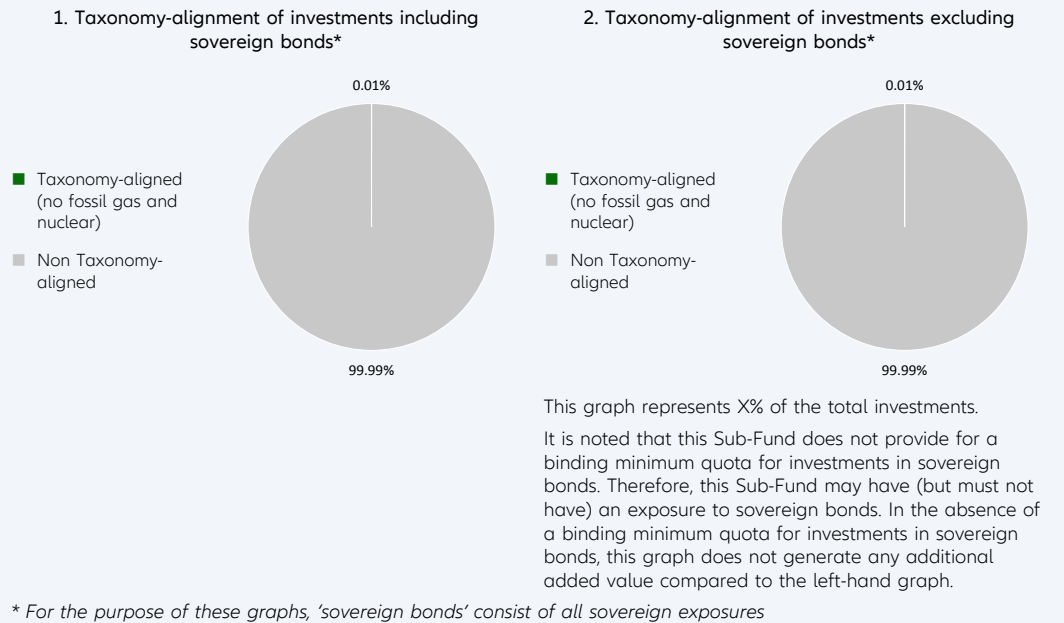

Enabling activities directly enable other activities to make a substantial contribution to an environmental objective.

Transitional activities are activities for which low-carbon alternatives are not yet available and among others have greenhouse gas emission levels corresponding to the best performance.

● **What is the minimum share of investments in transitional and enabling activities?**

The Sub-Fund's Investment Manager does not commit to a split of minimum taxonomy alignment into transitional, enabling activities and own performance.



What is the minimum share of sustainable investments with an environmental objective that are not aligned with the EU Taxonomy?

Taxonomy-aligned investments are considered a sub-category of Sustainable Investments. If an investment is not Taxonomy-aligned since the activity is not yet covered under the EU Taxonomy or the positive contribution is not substantial enough to comply with the Taxonomy technical screening criteria, the investment can still be considered an environmentally Sustainable Investment provided it complies with all criteria. The Investment Manager does not commit to a minimum share of environmentally Sustainable Investments that are not aligned with the EU Taxonomy. The overall sustainable investment share may also include investments with an environmental objective in economic activities that do not qualify as environmentally sustainable under the EU Taxonomy, and while the Sub-Fund cannot commit to a minimum share of environmentally or socially sustainable investments, such investments may be freely allocated to within the Sub-Fund aggregated sustainable investment commitment disclosed (min. 20%).

are sustainable investments with an environmental objective that **do not take into account the criteria** for environmentally sustainable economic activities under the EU Taxonomy.



What is the minimum share of socially sustainable investments?

The Investment Manager defines Sustainable Investments based on internal research, which uses, among others, the UN Sustainable Development Goals (SDGs), as well as the objectives of the EU Taxonomy as reference frameworks. The Investment Manager does not commit to a minimum share of socially Sustainable Investments, as the SDGs contain environmental as well as social objectives. The overall sustainable investment share may also include investments with a social objective, and while the Sub-Fund cannot commit to a minimum share of environmentally or socially sustainable investments, such investments may be freely allocated to within the Sub-Fund aggregated sustainable investment commitment disclosed (min. 20%).



What investments are included under “#2 Other”, what is their purpose and are there any minimum environmental or social safeguards?

Under “#2 Other” investments into cash, Target Funds, or derivatives can be included. Derivatives might be used for efficient portfolio management (including risk hedging) and/or investment purposes, and Target Funds to benefit from a specific strategy. For those investments no environmental or social safeguards are applied.



Is a specific index designated as a reference benchmark to determine whether this financial product is aligned with the environmental and/or social characteristics that it promotes?

Yes, the Sub-Fund has assigned MSCI USA ESG Screened Index as benchmark.

Reference benchmarks are indexes to measure whether the financial product attains the environmental or social characteristics that they promote.

- **How is the reference benchmark continuously aligned with each of the environmental or social characteristics promoted by the financial product?**

The Sub-Fund uses an ESG Screened benchmark which is however not completely aligned with the environmental or social characteristics promoted by the sub-fund. The MSCI USA ESG Screened Index exclude companies associated with controversial, civilian, nuclear weapons and tobacco, companies that derive revenues from thermal coal and oil sands extraction or that are not in compliance with the United Nations Global Compact (UNGC) principles. The indexes incorporate these exclusions while seeking to maintain a profile similar to market cap indexes.

- **How is the alignment of the investment strategy with the methodology of the index ensured on a continuous basis?**

The benchmark is not continuously aligned as the screening and exclusion criteria of the benchmark deviate from the Sub-Fund’s investment strategy.

- **How does the designated index differ from a relevant broad market index?**

The benchmark uses ESG exclusion criteria for index construction.

- **Where can the methodology used for the calculation of the designated index be found?**

Details of the Benchmarks’ methodology may be found at <https://www.msci.com/esg-screened-indexes> or at www.msci.com



Where can I find more product specific information online?

More product-specific information can be found on the website: <https://regulatory.allianzgi.com/SFDR>

Template pre-contractual disclosure for the financial products referred to in Article 8, paragraphs 1, 2 and 2a, of Regulation (EU) 2019/2088 and Article 6, first paragraph, of Regulation (EU) 2020/852

Product name:

Allianz Target Maturity Euro Bond I

Legal entity identifier: 529900AGQHNNHIYLXHR90

Environmental and/or social characteristics

Sustainable investment means an investment in an economic activity that contributes to an environmental or social objective, provided that the investment does not significantly harm any environmental or social objective and that the investee companies follow good governance practices.

The EU Taxonomy is a classification system laid down in Regulation (EU) 2020/852, establishing a list of **environmentally sustainable economic activities**. That Regulation does not include a list of socially sustainable economic activities. Sustainable investments with an environmental objective might be aligned with the Taxonomy or not.

Does this financial product have a sustainable investment objective?	
Yes	No
<input type="checkbox"/> It will make a minimum of sustainable investments with an environmental objective : ____% <ul style="list-style-type: none"> <input type="checkbox"/> in economic activities that qualify as environmentally sustainable under the EU Taxonomy <input type="checkbox"/> in economic activities that do not qualify as environmentally sustainable under the EU Taxonomy 	<input checked="" type="checkbox"/> It promotes Environmental/Social (E/S) characteristics and while it does not have as its objective a sustainable investment, it will have a minimum proportion of 5.00% of sustainable investments <ul style="list-style-type: none"> <input checked="" type="checkbox"/> with an environmental objective in economic activities that qualify as environmentally sustainable under the EU Taxonomy <input checked="" type="checkbox"/> with an environmental objective in economic activities that do not qualify as environmentally sustainable under the EU Taxonomy <input checked="" type="checkbox"/> with a social objective
<input type="checkbox"/> It will make a minimum of sustainable investments with a social objective ____%	<input type="checkbox"/> It promotes E/S characteristics, but will not make any sustainable investments



What environmental and/or social characteristics are promoted by this financial product?

Allianz Target Maturity Euro Bond I (the "Sub-Fund") is managed according to the Sustainability Key Performance Indicator Strategy (Relative) ("KPI Strategy (Relative)") which addresses greenhouse gas (GHG) intensity. The "Sustainability KPI" measures the GHG Intensity defined by the weighted average intensity of greenhouse gas emissions based on company's annual sales ("GHG Intensity").

GHG Intensity will be addressed by outperforming the Weighted Average GHG Intensity against its benchmark.

In addition, sustainable minimum exclusion criteria for direct investments apply.

A reference benchmark has been designated for the purpose of attaining the environmental or social characteristics promoted by the Sub-Fund

● What sustainability indicators are used to measure the attainment of each of the environmental or social characteristics promoted by this financial product?

To measure the attainment of the environmental and/or social characteristics the following sustainability indicators are used and reported on, at the fiscal year end:

- The actual percentage of KPI coverage of the Sub-Fund's Portfolio (Portfolio in this respect does not comprise non-rated derivatives and instruments that are non-rated by nature (e. g., cash and deposits))
- The actual weighted average GHG Intensity portfolio vs weighted average GHG Intensity of the benchmark

Sustainability indicators measure how the environmental or social characteristics promoted by the financial product are attained.

- Confirmation that Principal Adverse Impacts (PAIs) of investment decisions on sustainability factors are considered through the application of exclusion criteria.
- **What are the objectives of the sustainable investments that the financial product partially intends to make and how does the sustainable investment contribute to such objectives?**

Sustainable investments contribute to environmental and/or social objectives, for which the Investment Managers uses as reference frameworks, among others, the UN Sustainable Development Goals (SDGs), as well as the objectives of the EU Taxonomy:

1. Climate Change Mitigation
2. Climate Change Adaptation
3. Sustainable Use and Protection of Water and Marine Resources
4. Transition to a Circular Economy
5. Pollution Prevention and Control
6. Protection and Restoration of Biodiversity and Ecosystems

The assessment of the positive contribution to the environmental or social objectives is based on a proprietary framework which combines quantitative elements with qualitative inputs from internal research. The methodology applies first a quantitative breakdown of securities issuer into its business activities. The qualitative element of the framework is an assessment if business activities contribute positively to an environmental or a social objective.

To calculate the positive contribution on the Fund level the revenue share of each issuer attributable to business activities contributing to environmental and/or social objectives is considered provided the issuer is satisfying the Do No Significant Harm (“DNSH”) and Good Governance principles, and an asset-weighted aggregation is performed as a second step. Moreover, for certain types of securities, which finance specific projects contributing to environmental or social objectives the overall investment is considered to contribute to environmental and/or social objectives, but also for these a DNSH as well as a Good Governance check for issuers is performed.

- **How do the sustainable investments that the financial product partially intends to make, not cause significant harm to any environmental or social sustainable investment objective?**

In order to ensure that Sustainable Investments do not significantly harm any other environmental and/or social objective, the Investment Manager is leveraging the PAI indicators, whereby significance thresholds have been defined to identify significantly harmful issuers. Issuers not meeting the significance threshold can be engaged for a limited time period to remediate the adverse impact. Otherwise, if the issuer does not meet the defined significance thresholds twice subsequently or in case of a failed engagement, it does not pass the DNSH assessment. Investments in securities of issuers which do not pass the DNSH assessment are not counted as sustainable investments.

- *How have the indicators for adverse impacts on sustainability factors been taken into account?*

All mandatory PAI indicators are considered either as part of the application of the exclusion criteria or through thresholds on a sectorial or absolute basis. Significance thresholds have been defined and they refer to a qualitative or quantitative criteria.

Recognizing the lack of data coverage for some of the PAI indicators equivalent data points are used to assess PAI indicators when applying the DNSH assessment, when relevant, for the following indicators for corporates: share of non-renewable energy consumption and production, activities negatively affecting biodiversity-sensitive areas, emissions to water, lack of processes and compliance mechanisms to monitor compliance with UNGC principles and OECD Guidelines for Multinational Enterprises; for sovereigns: GHG Intensity and investee countries subject to social violations. In case of securities which finance specific projects contributing to environmental or social objectives equivalent data at project level might be used to ensure that Sustainable Investments do not significantly harm any other environmental and/or social objective. The Investment Manager will strive to increase data coverage for PAI indicators with low data coverage by engaging with issuers and data providers. The Investment Manager will regularly evaluate whether the availability of data has increased sufficiently to potentially include assessment of such data in the investment process.

Principal adverse impacts are the most significant negative impacts of investment decisions on sustainability factors relating to environmental, social and employee matters, respect for human rights, anti-corruption and anti-bribery matters.

- *How are the sustainable investments aligned with the OECD Guidelines for Multinational Enterprises and the UN Guiding Principles on Business and Human Rights? Details:*

The Investment Manager's sustainable minimum exclusion list screens out companies based on their involvement in controversial practices against international norms. The core normative framework consists of the Principles of the UN Global Compact, the OECD Guidelines for Multinational Enterprises and the UN Guiding Principles for Business and Human Rights. Securities issued by companies having a severe violation of these frameworks will be restricted from investment universe.

The EU Taxonomy sets out a "do not significant harm" principle by which Taxonomy-aligned investments should not significantly harm EU Taxonomy objectives and is accompanied by specific EU criteria.

The "do not significant harm" principle applies only to those investments underlying the financial product that take into account the EU criteria for environmentally sustainable economic activities. The investments underlying the remaining portion of this financial product do not take into account the EU criteria for environmentally sustainable economic activities.

Any other sustainable investments must also not significantly harm any environmental or social objectives.



Does this financial product consider principal adverse impacts on sustainability factors?

Yes

No

The Management Company has joined the Net Zero Asset Manager Initiative and considers PAI indicators through stewardship including engagement, both are relevant to mitigate potential adverse impact as a company.

Due to the commitment to the Net Zero Asset Manager Initiative, the Management Company aims to reduce greenhouse gas emissions in partnership with asset owner clients on decarbonisation goals, consistent with an ambition to reach net zero emission by 2050 or sooner across all assets under management. As part of this objective the Management Company will set an interim target for the proportion of assets to be managed in line with the attainment of net zero emissions by 2050 or sooner.

The Sub-Fund's Investment Manager addresses PAI indicators regarding greenhouse gas emission, biodiversity, water, waste as well as social and employee matters for corporate issuers, and, where relevant, the freedom house index is applied to investments in sovereigns. PAI indicators are considered within the Investment Manager's investment process through the means of exclusions as described in the "binding elements" section of the Sub-Fund.

The data coverage for the data required for the PAI indicators is heterogenous. The data coverage related to biodiversity, water and waste is low and the related PAI indicators are considered through exclusion of securities issued by companies having a severe violation / breach of principles and guidelines such as the Principles of the United Nations Global Compact, the OECD Guidelines for Multinational Enterprises, and the United Nations Guiding Principles for Business and Human Rights on the grounds of problematic practices around human rights, labour rights, environment, and corruption issues. Therefore, the Investment Manager will strive to increase data coverage for PAI indicators with low data coverage. The Investment Manager will regularly evaluate whether the availability of data has increased sufficiently to potentially include assessment of such data in the investment process.

Additionally, the Investment manager considers GHG related PAI indicators by outperforming the Weighted Average GHG Intensity against its benchmark. The following PAI indicators are considered:

Applicable to corporate issuers

- GHG Emissions
- Carbon footprint
- GHG Intensity of investee companies
- Exposure to companies active in the fossil fuel sector
- Activities negatively affecting biodiversity-sensitive areas
- Emissions to water
- Hazardous waste ratio
- Violation of UN Global compact principles

- Lack of processes and compliance mechanisms to monitor compliance with UN Global Compact principles
- Board gender diversity
- Exposure to controversial weapons

Applicable to sovereign and supranational issuers

- Investee countries subject to social violations

The information on the PAI indicators will be available in the end-year report of the Sub-Fund.



What investment strategy does this financial product follow?

The investment strategy guides investment decisions based on factors such as investment objectives and risk tolerance.

Allianz Target Maturity Euro Bond I's investment objective is to invest in Debt Securities of Global bond markets (Euro denominated) in accordance with the Sustainability Key Performance Indicator Strategy (Relative) ("KPI Strategy (Relative)")

The Sub-Fund's strategy is to outperform the Weighted Average GHG Intensity against its benchmark. The outperformance is determined as the excess between the Sub-Fund's weighted average GHG Intensity and the Sub-Fund's benchmark Weighted Average GHG Intensity.

The weighted average GHG Intensity is the weighted average of the Sub-Fund's GHG Intensity (in tCO₂e per Millions of sales). Sales represent company's annual sales. This ratio of GHG normalized by Sales facilitates comparison between companies of different sizes. The ratio is in tCO₂e per Millions of sales. The metric allows comparing weighted average GHG Intensities of different portfolios to identify portfolios comprised of more GHG-efficient issuers in terms of the issuer's sales. The portfolio weights (and benchmark or universe weights) are rebased such that only issuers with GHG emissions data available are considered in the calculation. GHG represents a respective issuer's greenhouse gas emissions. To determine the GHG Intensity of a company issuer, GHG Intensity data from third party data providers will be used. The GHG intensity is analysed by the Investment Manager and is considered within the securities selection process in order to meet the Sub-Fund Investment objective.

The proportion of assets which do not have a GHG intensity assessment is expected to be low. Examples of instruments not having a GHG intensity assessment are cash and deposits, some Target Funds, and investments for which the GHG intensity is deemed to be not appropriate and/or data is not available.

The Sub-Fund's general investment approach (Sub-Fund's applicable General Asset Class Principles in combination with its individual investment restrictions) is described in the prospectus.

● What are the binding elements of the investment strategy used to select the investments to attain each of the environmental or social characteristics promoted by this financial product?

The binding elements are:

- Min. 80% KPI coverage of the Sub-Fund's Portfolio (Portfolio in this respect does not comprise non-rated derivatives and instruments that are non-rated by nature (e. g., cash and deposits))
- Min. 20% outperformance of benchmark in terms of Weighted Average GHG Intensity
- Application of the following sustainable minimum exclusion criteria for direct investments:
 - securities issued by companies having a severe violation / breach of principles and guidelines such as the Principles of the United Nations Global Compact, the OECD Guidelines for Multinational Enterprises, and the United Nations Guiding Principles for Business and Human Rights on the grounds of problematic practices around human rights, labour rights, environment, and corruption issues,
 - securities issued by companies involved in controversial weapons (anti-personnel mines, cluster munitions, chemical weapons, biological weapons, depleted uranium, white phosphorus, and nuclear weapons),
 - securities issued by companies that derive more than 10% of their revenues from weapons, military equipment, and services,
 - securities issued by companies that derive more than 10% of their revenue from thermal coal extraction,
 - securities issued by utility companies that generate more than 20% of their revenues from coal,
 - securities issued by companies involved in the production of tobacco, and securities issued by companies involved in the distribution of tobacco with more than 5% of their revenues.

Direct investments in sovereign issuers with an insufficient freedom house index score are excluded.

The sustainable minimum exclusion criteria are based on information from an external data provider and coded in pre- and post-trade compliance. The review is performed at least half yearly.

- **What is the committed minimum rate to reduce the scope of the investments considered prior to the application of that investment strategy?**

The Sub-Fund does not commit to reduce the scope of the investments by a certain minimum rate.

- **What is the policy to assess good governance practices of the investee companies?**

Good governance principles are considered by screening out companies based on their involvement in controversies around international norms corresponding to the four good governance practices: sound management structures, employee relations, remuneration of staff and tax compliance. Companies having a severe violation in either of those areas will not be investible. For certain cases, flagged issuers shall be on a watch list. These companies will appear on this watch list when the Investment Manager believes that engagement may lead to improvements or when the company is assessed to take remedial actions. Companies on the watch list remain investible unless the Investment Manager believes that our engagement or the remedial actions of the company does not lead to the desired remedy of the severe controversy.

In addition, the Sub-Fund's Investment Manager is committed to actively encourage open dialogues with investee companies on corporate governance, proxy voting and broader sustainability issues in advance of shareholder meetings (regularly for direct investments in shares). The Sub-Fund's Investment Manager's approach to proxy voting and company engagement is set out in the Management Company's Stewardship Statement.

Good governance practices include sound management structures, employee relations, remuneration of staff and tax compliance.



What is the asset allocation planned for this financial product?

Asset allocation describes the share of investments in specific assets.

Min. 80% of the Sub-Funds' assets (excluding cash, and derivatives) are used to meet the environmental or social characteristics promoted by this Sub-Fund. A low portion of the Sub-Fund might contain assets which do not promote environmental or social characteristics. Examples of such instruments are derivatives, cash and deposits, some Target Funds and investment with temporarily divergent or absent environmental, social, or good governance qualifications. Min. 5% of the Sub-Funds' assets will be invested in Sustainable Investments. The minimum percentage of investments that are aligned with the EU Taxonomy is 0.01%. The Sub-Fund's Investment Manager does not commit to a minimum share of environmentally Sustainable Investments that are not aligned with the EU Taxonomy. The Sub-Fund's Investment Manager does not commit to a minimum share of socially sustainable investments. While the Sub-Fund cannot commit to a minimum share of environmentally or socially sustainable investments, such investments may be freely allocated to within the Sub-Fund aggregated sustainable investment commitment disclosed (min. 5%).

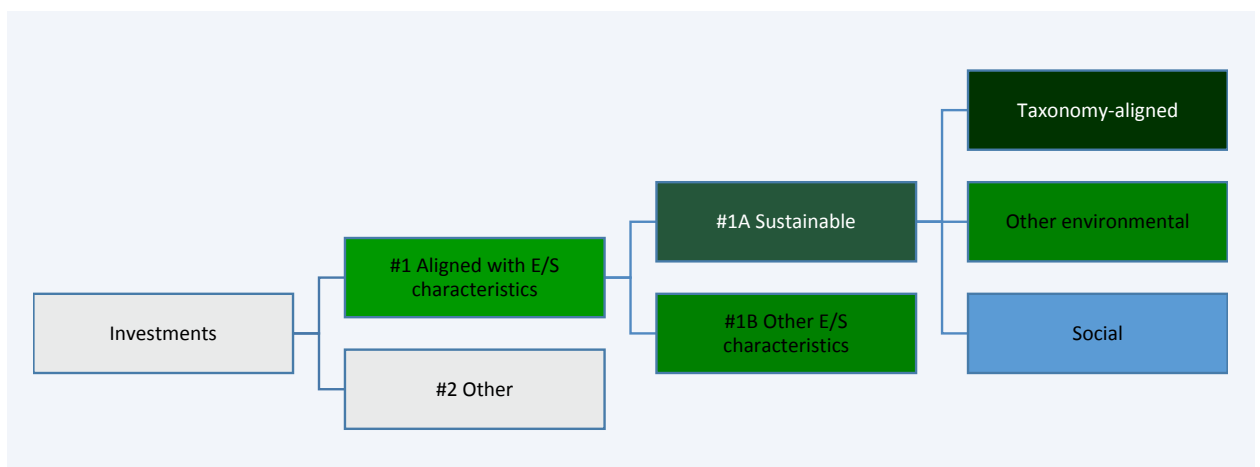

#1 Aligned with E/S characteristics includes the investments of the financial product used to attain the environmental or social characteristics promoted by the financial product.

#2 Other includes the remaining investments of the financial product which are neither aligned with the environmental or social characteristics, nor are qualified as sustainable investments.

The category **#1 Aligned with E/S characteristics** covers:

- The sub-category **#1A Sustainable** covers sustainable investments with environmental or social objectives.

- The sub-category #1B Other E/S characteristics covers investments aligned with the environmental or social characteristics that do not qualify as sustainable investments.

● **How does the use of derivatives attain the environmental or social characteristics promoted by the financial product?**

Not applicable



To what minimum extent are sustainable investments with an environmental objective aligned with the EU Taxonomy?

The Taxonomy-aligned investments include debt and/or equity in environmentally sustainable economic activities aligned with the EU-Taxonomy. The minimum percentage of investments that are aligned with the EU Taxonomy is 0.01%. Taxonomy-aligned data is provided by an external data provider. The Investment Manager has assessed the quality of such data. The data will not be subject to an assurance provided by auditors or a review by third parties. The data will not reflect any data in government bonds. As of today, there is no recognized methodology available to determine the proportion of Taxonomy-aligned activities when investing in government bonds.

Taxonomy-aligned activities in this disclosure are based on share of turnover. Pre-contractual figures use turnover as its financial metric as a default in line with the regulatory requirements and based on the fact that complete, verifiable or up-to date data for CAPEX and/or OPEX as financial metric is even less available.

Taxonomy-aligned data is only in rare cases data reported by companies in accordance with the EU Taxonomy. The data provider has derived Taxonomy-aligned data from other available equivalent public data.

● **Does the financial product invest in fossil gas and/or nuclear energy related activities that comply with the EU Taxonomy ¹?**

- Yes:
 In fossil gas In nuclear energy
 No

The Sub-Fund does not pursue any investments in fossil gas and/or nuclear energy related activities that comply with the EU Taxonomy. Nevertheless, as result of this investment strategy, investments may occur in corporates which are also active in these activities. Further information will be provided as part of the annual reporting, if relevant.

The two graphs below show in green the minimum percentage of investments that are aligned with the EU Taxonomy. As there is no appropriate methodology to determine the Taxonomy-alignment of sovereign bonds*, the first graph shows the Taxonomy-alignment in relation to all the investments of the financial product including sovereign bonds, while the second graph shows the Taxonomy-alignment only in relation to the investments of the financial product other than sovereign bonds.

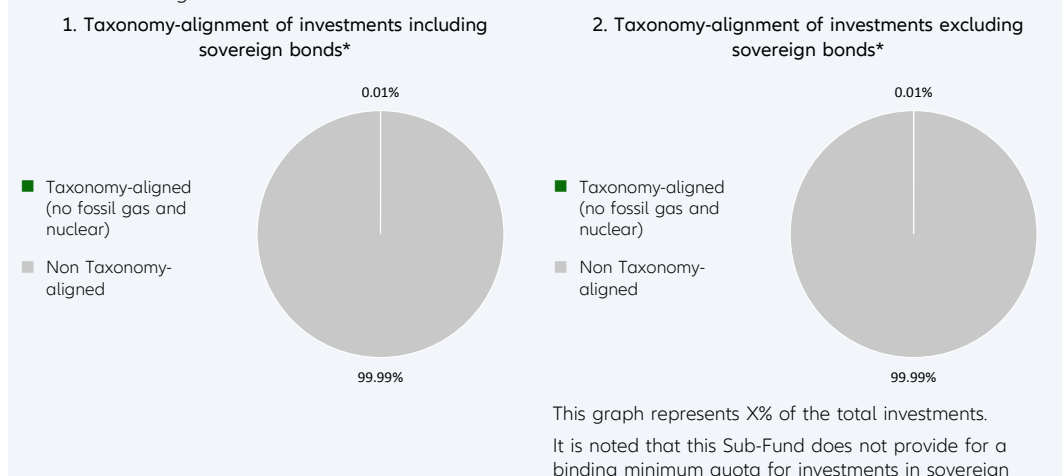

¹ Fossil gas and/or nuclear related activities will only comply with the EU Taxonomy where they contribute to limiting climate change ("climate change mitigation") and do not significantly harm any EU Taxonomy objective - see explanatory note in the left hand margin. The full criteria for fossil gas and nuclear energy economic activities that comply with the EU Taxonomy are laid down in Commission Delegated Regulation (EU) 2022/1214.

bonds. Therefore, this Sub-Fund may have (but must not have) an exposure to sovereign bonds. In the absence of a binding minimum quota for investments in sovereign bonds, this graph does not generate any additional added value compared to the left-hand graph.

** For the purpose of these graphs, 'sovereign bonds' consist of all sovereign exposures*

Enabling activities directly enable other activities to make a substantial contribution to an environmental objective.

Transitional activities are activities for which low-carbon alternatives are not yet available and among others have greenhouse gas emission levels corresponding to the best performance.

● What is the minimum share of investments in transitional and enabling activities?

The Investment Manager does not commit to a split of minimum taxonomy alignment into transitional and enabling activities and own performance.



What is the minimum share of sustainable investments with an environmental objective that are not aligned with the EU Taxonomy?

Taxonomy-aligned investments are considered a sub-category of Sustainable Investments. If an investment is not Taxonomy-aligned since the activity is not yet covered under the EU Taxonomy or the positive contribution is not substantial enough to comply with the Taxonomy technical screening criteria, the investment can still be considered an environmentally Sustainable Investment provided it complies with all criteria. The Investment Manager does not commit to a minimum share of environmentally Sustainable Investments that are not aligned with the EU Taxonomy. The overall sustainable investment share may also include investments with an environmental objective in economic activities that do not qualify as environmentally sustainable under the EU Taxonomy, and while the Sub-Fund cannot commit to a minimum share of environmentally or socially sustainable investments, such investments may be freely allocated to within the Sub-Fund aggregated sustainable investment commitment disclosed (min. 5%).



are sustainable investments with an environmental objective that **do not take into account the criteria** for environmentally sustainable economic activities under the EU Taxonomy.



What is the minimum share of socially sustainable investments?

The Investment Manager defines Sustainable Investments based on internal research, which uses, among others, the UN Sustainable Development Goals (SDGs), as well as the objectives of the EU Taxonomy as reference frameworks. The Investment Manager does not commit to a minimum share of socially Sustainable Investments, as the SDGs contain environmental as well as social objectives. The overall sustainable investment share may also include investments with a social objective, and while the Sub-Fund cannot commit to a minimum share of environmentally or socially sustainable investments, such investments may be freely allocated to within the Sub-Fund aggregated sustainable investment commitment disclosed (min. 5%).



What investments are included under “#2 Other”, what is their purpose and are there any minimum environmental or social safeguards?

Under “#2 Other” investments into cash, Target Funds, or derivatives can be included. Derivatives might be used for efficient portfolio management (including risk hedging) and/or investment purposes, and Target Funds to benefit from a specific strategy. For those investments no environmental or social safeguards are applied.



Is a specific index designated as a reference benchmark to determine whether this financial product is aligned with the environmental and/or social characteristics that it promotes?

Yes, the Sub-Fund has assigned the ICE BofA Euro Corporate Index as a benchmark. This benchmark is a market index. The Sub-Fund will promote environmental and social characteristics by outperforming the benchmark's Weighted Average GHG Intensity

Reference benchmarks are indexes to measure whether the financial product attains the environmental or social characteristics that they promote.

- **How is the reference benchmark continuously aligned with each of the environmental or social characteristics promoted by the financial product?**

The benchmark is a market index and does not incorporate environmental or social characteristics for index construction.

- **How is the alignment of the investment strategy with the methodology of the index ensured on a continuous basis?**

The benchmark is not continuously aligned as it does not incorporate environmental or social characteristics for index construction.

- **How does the designated index differ from a relevant broad market index?**

The benchmark is a broad market index.

- **Where can the methodology used for the calculation of the designated index be found?**

Details of the Benchmark's methodology may be found at <https://www.theice.com/market-data/indices/fixed-income-indices>



Where can I find more product specific information online?

More product-specific information can be found on the website: <https://regulatory.allianzgi.com/SFDR>

Template pre-contractual disclosure for the financial products referred to in Article 8, paragraphs 1, 2 and 2a, of Regulation (EU) 2019/2088 and Article 6, first paragraph, of Regulation (EU) 2020/852

Product name:

Allianz Target Maturity Euro Bond II

Legal entity identifier: New Product - Not Identified

Environmental and/or social characteristics

Sustainable investment means an investment in an economic activity that contributes to an environmental or social objective, provided that the investment does not significantly harm any environmental or social objective and that the investee companies follow good governance practices.

The EU Taxonomy is a classification system laid down in Regulation (EU) 2020/852, establishing a list of **environmentally sustainable economic activities**. That Regulation does not include a list of socially sustainable economic activities. Sustainable investments with an environmental objective might be aligned with the Taxonomy or not.

Does this financial product have a sustainable investment objective?

<input checked="" type="radio"/> <input checked="" type="radio"/> Yes		<input checked="" type="radio"/> <input type="radio"/> No	
<input type="checkbox"/> It will make a minimum of sustainable investments with an environmental objective: ___%	<input checked="" type="checkbox"/> It promotes Environmental/Social (E/S) characteristics and while it does not have as its objective a sustainable investment, it will have a minimum proportion of 5.00% of sustainable investments	<input type="checkbox"/> in economic activities that qualify as environmentally sustainable under the EU Taxonomy	<input checked="" type="checkbox"/> with an environmental objective in economic activities that qualify as environmentally sustainable under the EU Taxonomy
<input type="checkbox"/> in economic activities that do not qualify as environmentally sustainable under the EU Taxonomy	<input checked="" type="checkbox"/> with an environmental objective in economic activities that do not qualify as environmentally sustainable under the EU Taxonomy	<input type="checkbox"/> It will make a minimum of sustainable investments with a social objective ___%	<input checked="" type="checkbox"/> with a social objective
<input type="checkbox"/> It promotes E/S characteristics, but will not make any sustainable investments			



What environmental and/or social characteristics are promoted by this financial product?

Allianz Target Maturity Euro Bond II (the "Sub-Fund") is managed according to the Sustainability Key Performance Indicator Strategy (Relative) ("KPI Strategy (Relative)") which addresses greenhouse gas (GHG) intensity. The "Sustainability KPI" measures the GHG Intensity defined by the weighted average intensity of greenhouse gas emissions based on company's annual sales ("GHG Intensity").

GHG Intensity will be addressed by outperforming the Weighted Average GHG Intensity against its benchmark.

In addition, sustainable minimum exclusion criteria for direct investments apply.

A reference benchmark has been designated for the purpose of attaining the environmental or social characteristics promoted by the Sub-Fund

● What sustainability indicators are used to measure the attainment of each of the environmental or social characteristics promoted by this financial product?

To measure the attainment of the environmental and/or social characteristics the following sustainability indicators are used and reported on, at the fiscal year end:

- The actual percentage of KPI coverage of the Sub-Fund's Portfolio (Portfolio in this respect does not comprise non-rated derivatives and instruments that are non-rated by nature (e. g., cash and deposits))
- The actual weighted average GHG Intensity portfolio vs weighted average GHG Intensity of the benchmark

Sustainability indicators measure how the environmental or social characteristics promoted by the financial product are attained.

- Confirmation that Principal Adverse Impacts (PAIs) of investment decisions on sustainability factors are considered through the application of exclusion criteria.
- **What are the objectives of the sustainable investments that the financial product partially intends to make and how does the sustainable investment contribute to such objectives?**

Sustainable investments contribute to environmental and/or social objectives, for which the Investment Managers uses as reference frameworks, among others, the UN Sustainable Development Goals (SDGs), as well as the objectives of the EU Taxonomy:

1. Climate Change Mitigation
2. Climate Change Adaptation
3. Sustainable Use and Protection of Water and Marine Resources
4. Transition to a Circular Economy
5. Pollution Prevention and Control
6. Protection and Restoration of Biodiversity and Ecosystems

The assessment of the positive contribution to the environmental or social objectives is based on a proprietary framework which combines quantitative elements with qualitative inputs from internal research. The methodology applies first a quantitative breakdown of securities issuer into its business activities. The qualitative element of the framework is an assessment if business activities contribute positively to an environmental or a social objective.

To calculate the positive contribution on the Fund level the revenue share of each issuer attributable to business activities contributing to environmental and/or social objectives is considered provided the issuer is satisfying the Do No Significant Harm (“DNSH”) and Good Governance principles, and an asset-weighted aggregation is performed as a second step. Moreover, for certain types of securities, which finance specific projects contributing to environmental or social objectives the overall investment is considered to contribute to environmental and/or social objectives, but also for these a DNSH as well as a Good Governance check for issuers is performed.

- **How do the sustainable investments that the financial product partially intends to make, not cause significant harm to any environmental or social sustainable investment objective?**

In order to ensure that Sustainable Investments do not significantly harm any other environmental and/or social objective, the Investment Manager is leveraging the PAI indicators, whereby significance thresholds have been defined to identify significantly harmful issuers. Issuers not meeting the significance threshold can be engaged for a limited time period to remediate the adverse impact. Otherwise, if the issuer does not meet the defined significance thresholds twice subsequently or in case of a failed engagement, it does not pass the DNSH assessment. Investments in securities of issuers which do not pass the DNSH assessment are not counted as sustainable investments.

- *How have the indicators for adverse impacts on sustainability factors been taken into account?*

All mandatory PAI indicators are considered either as part of the application of the exclusion criteria or through thresholds on a sectorial or absolute basis. Significance thresholds have been defined and they refer to a qualitative or quantitative criteria.

Recognizing the lack of data coverage for some of the PAI indicators equivalent data points are used to assess PAI indicators when applying the DNSH assessment, when relevant, for the following indicators for corporates: share of non-renewable energy consumption and production, activities negatively affecting biodiversity-sensitive areas, emissions to water, lack of processes and compliance mechanisms to monitor compliance with UNGC principles and OECD Guidelines for Multinational Enterprises; for sovereigns: GHG Intensity and investee countries subject to social violations. In case of securities which finance specific projects contributing to environmental or social objectives equivalent data at project level might be used to ensure that Sustainable Investments do not significantly harm any other environmental and/or social objective. The Investment Manager will strive to increase data coverage for PAI indicators with low data coverage by engaging with issuers and data providers. The Investment Manager will regularly evaluate whether the availability of data has increased sufficiently to potentially include assessment of such data in the investment process.

Principal adverse impacts are the most significant negative impacts of investment decisions on sustainability factors relating to environmental, social and employee matters, respect for human rights, anti-corruption and anti-bribery matters.

- *How are the sustainable investments aligned with the OECD Guidelines for Multinational Enterprises and the UN Guiding Principles on Business and Human Rights? Details:*

The Investment Manager's sustainable minimum exclusion list screens out companies based on their involvement in controversial practices against international norms. The core normative framework consists of the Principles of the UN Global Compact, the OECD Guidelines for Multinational Enterprises and the UN Guiding Principles for Business and Human Rights. Securities issued by companies having a severe violation of these frameworks will be restricted from investment universe.

The EU Taxonomy sets out a "do not significant harm" principle by which Taxonomy-aligned investments should not significantly harm EU Taxonomy objectives and is accompanied by specific EU criteria.

The "do not significant harm" principle applies only to those investments underlying the financial product that take into account the EU criteria for environmentally sustainable economic activities. The investments underlying the remaining portion of this financial product do not take into account the EU criteria for environmentally sustainable economic activities.

Any other sustainable investments must also not significantly harm any environmental or social objectives.



Does this financial product consider principal adverse impacts on sustainability factors?

Yes

No

The Management Company has joined the Net Zero Asset Manager Initiative and considers PAI indicators through stewardship including engagement, both are relevant to mitigate potential adverse impact as a company.

Due to the commitment to the Net Zero Asset Manager Initiative, the Management Company aims to reduce greenhouse gas emissions in partnership with asset owner clients on decarbonisation goals, consistent with an ambition to reach net zero emission by 2050 or sooner across all assets under management. As part of this objective the Management Company will set an interim target for the proportion of assets to be managed in line with the attainment of net zero emissions by 2050 or sooner.

The Sub-Fund's Investment Manager addresses PAI indicators regarding greenhouse gas emission, biodiversity, water, waste as well as social and employee matters for corporate issuers, and, where relevant, the freedom house index is applied to investments in sovereigns. PAI indicators are considered within the Investment Manager's investment process through the means of exclusions as described in the "environmental and/or social characteristics" section of the Sub-Fund.

The data coverage for the data required for the PAI indicators is heterogenous. The data coverage related to biodiversity, water and waste is low and the related PAI indicators are considered through exclusion of securities issued by companies having a severe violation / breach of principles and guidelines such as the Principles of the United Nations Global Compact, the OECD Guidelines for Multinational Enterprises, and the United Nations Guiding Principles for Business and Human Rights on the grounds of problematic practices around human rights, labour rights, environment, and corruption issues. Therefore, the Investment Manager will strive to increase data coverage for PAI indicators with low data coverage. The Investment Manager will regularly evaluate whether the availability of data has increased sufficiently to potentially include assessment of such data in the investment process.

Additionally, the Investment manager considers GHG related PAI indicators by outperforming the Weighted Average GHG Intensity against its benchmark. The following PAI indicators are considered:

Applicable to corporate issuers

- GHG Emissions
- Carbon footprint
- GHG Intensity of investee companies
- Exposure to companies active in the fossil fuel sector
- Activities negatively affecting biodiversity-sensitive areas
- Emissions to water
- Hazardous waste ratio
- Violation of UN Global compact principles

- Lack of processes and compliance mechanisms to monitor compliance with UN Global Compact principles
- Board gender diversity
- Exposure to controversial weapons

Applicable to sovereign and supranational issuers

- Investee countries subject to social violations

The information on the PAI indicators will be available in the end-year report of the Sub-Fund.



What investment strategy does this financial product follow?

The investment strategy guides investment decisions based on factors such as investment objectives and risk tolerance.

Allianz Target Maturity Euro Bond II's investment objective is to invest in Debt Securities of Global bond markets (Euro denominated) in accordance with the Sustainability Key Performance Indicator Strategy (Relative) ("KPI Strategy (Relative)")

The Sub-Fund's strategy is to outperform the Weighted Average GHG Intensity against its benchmark. The outperformance is determined as the excess between the Sub-Fund's weighted average GHG Intensity and the Sub-Fund's benchmark Weighted Average GHG Intensity.

The weighted average GHG Intensity is the weighted average of the Sub-Fund's GHG Intensity (in tCO₂e per Millions of sales). Sales represent company's annual sales. This ratio of GHG normalized by Sales facilitates comparison between companies of different sizes. The ratio is in tCO₂e per Millions of sales. The metric allows comparing weighted average GHG Intensities of different portfolios to identify portfolios comprised of more GHG-efficient issuers in terms of the issuer's sales. The portfolio weights (and benchmark or universe weights) are rebased such that only issuers with GHG emissions data available are considered in the calculation. GHG represents a respective issuer's greenhouse gas emissions. To determine the GHG Intensity of a company issuer, GHG Intensity data from third party data providers will be used. The GHG intensity is analysed by the Investment Manager and is considered within the securities selection process in order to meet the Sub-Fund Investment objective.

The proportion of assets which do not have a GHG intensity assessment is expected to be low. Examples of instruments not having a GHG intensity assessment are cash and deposits, some Target Funds, and investments for which the GHG intensity is deemed to be not appropriate and/or data is not available.

The Sub-Fund's general investment approach (Sub-Fund's applicable General Asset Class Principles in combination with its individual investment restrictions) is described in the prospectus.

● What are the binding elements of the investment strategy used to select the investments to attain each of the environmental or social characteristics promoted by this financial product?

The binding elements are:

- Min. 80% KPI coverage of the Sub-Fund's Portfolio (Portfolio in this respect does not comprise non-rated derivatives and instruments that are non-rated by nature (e. g., cash and deposits))
- Min. 20% outperformance of benchmark in terms of Weighted Average GHG Intensity
- Application of the following sustainable minimum exclusion criteria for direct investments:
 - securities issued by companies having a severe violation / breach of principles and guidelines such as the Principles of the United Nations Global Compact, the OECD Guidelines for Multinational Enterprises, and the United Nations Guiding Principles for Business and Human Rights on the grounds of problematic practices around human rights, labour rights, environment, and corruption issues,
 - securities issued by companies involved in controversial weapons (anti-personnel mines, cluster munitions, chemical weapons, biological weapons, depleted uranium, white phosphorus, and nuclear weapons),
 - securities issued by companies that derive more than 10% of their revenues from weapons, military equipment, and services,
 - securities issued by companies that derive more than 10% of their revenue from thermal coal extraction,
 - securities issued by utility companies that generate more than 20% of their revenues from coal,
 - securities issued by companies involved in the production of tobacco, and securities issued by companies involved in the distribution of tobacco with more than 5% of their revenues.

Direct investments in sovereign issuers with an insufficient freedom house index score are excluded.

The sustainable minimum exclusion criteria are based on information from an external data provider and coded in pre- and post-trade compliance. The review is performed at least half yearly.

- **What is the committed minimum rate to reduce the scope of the investments considered prior to the application of that investment strategy?**

The Sub-Fund does not commit to reduce the scope of the investments by a certain minimum rate.

- **What is the policy to assess good governance practices of the investee companies?**

Good governance principles are considered by screening out companies based on their involvement in controversies around international norms corresponding to the four good governance practices: sound management structures, employee relations, remuneration of staff and tax compliance. Companies having a severe violation in either of those areas will not be investible. For certain cases, flagged issuers shall be on a watch list. These companies will appear on this watch list when the Investment Manager believes that engagement may lead to improvements or when the company is assessed to take remedial actions. Companies on the watch list remain investible unless the Investment Manager believes that our engagement or the remedial actions of the company does not lead to the desired remedy of the severe controversy.

In addition, the Sub-Fund’s Investment Manager is committed to actively encourage open dialogues with investee companies on corporate governance, proxy voting and broader sustainability issues in advance of shareholder meetings (regularly for direct investments in shares). The Sub-Fund’s Investment Manager’s approach to proxy voting and company engagement is set out in the Management Company’s Stewardship Statement.

Good governance practices include sound management structures, employee relations, remuneration of staff and tax compliance.



What is the asset allocation planned for this financial product?

Asset allocation describes the share of investments in specific assets.

Min. 80% of the Sub-Funds’ assets (excluding cash, and derivatives) are used to meet the environmental or social characteristics promoted by this Sub-Fund. A low portion of the Sub-Fund might contain assets which do not promote environmental or social characteristics. Examples of such instruments are derivatives, cash and deposits, some Target Funds and investment with temporarily divergent or absent environmental, social, or good governance qualifications. Min. 5% of the Sub-Funds’ assets will be invested in Sustainable Investments. The minimum percentage of investments that are aligned with the EU Taxonomy is 0.01%. The Sub-Fund’s Investment Manager does not commit to a minimum share of environmentally Sustainable Investments that are not aligned with the EU Taxonomy. The Sub-Fund’s Investment Manager does not commit to a minimum share of socially sustainable investments. While the Sub-Fund cannot commit to a minimum share of environmentally or socially sustainable investments, such investments may be freely allocated to within the Sub-Fund aggregated sustainable investment commitment disclosed (min. 5%).

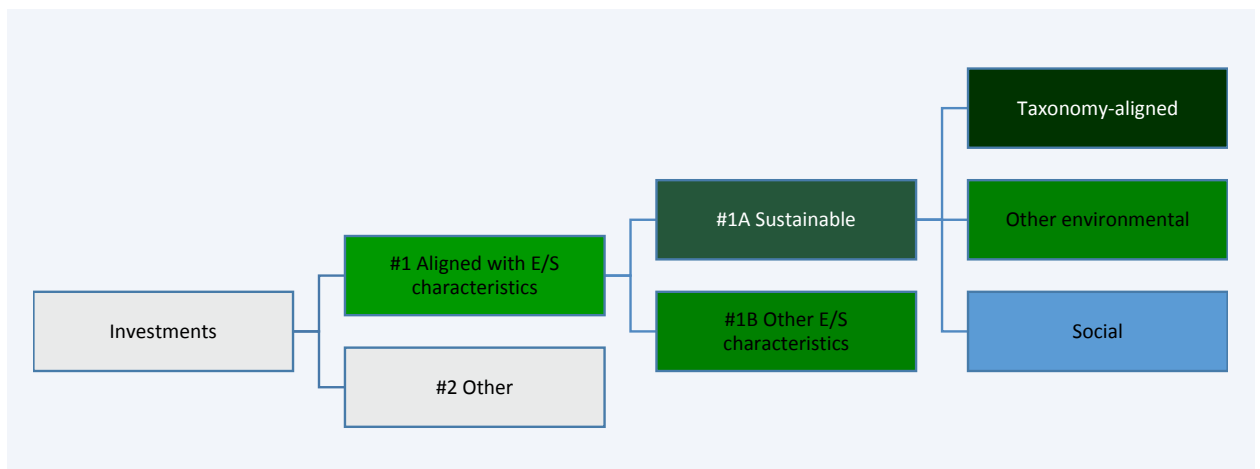

#1 Aligned with E/S characteristics includes the investments of the financial product used to attain the environmental or social characteristics promoted by the financial product.

#2 Other includes the remaining investments of the financial product which are neither aligned with the environmental or social characteristics, nor are qualified as sustainable investments.

The category **#1 Aligned with E/S characteristics** covers:

- The sub-category **#1A Sustainable** covers sustainable investments with environmental or social objectives.

- The sub-category #1B Other E/S characteristics covers investments aligned with the environmental or social characteristics that do not qualify as sustainable investments.

● **How does the use of derivatives attain the environmental or social characteristics promoted by the financial product?**

Not applicable



To what minimum extent are sustainable investments with an environmental objective aligned with the EU Taxonomy?

The Taxonomy-aligned investments include debt and/or equity in environmentally sustainable economic activities aligned with the EU-Taxonomy. The minimum percentage of investments that are aligned with the EU Taxonomy is 0.01%. Taxonomy-aligned data is provided by an external data provider. The Investment Manager has assessed the quality of such data. The data will not be subject to an assurance provided by auditors or a review by third parties. The data will not reflect any data in government bonds. As of today, there is no recognized methodology available to determine the proportion of Taxonomy-aligned activities when investing in government bonds.

Taxonomy-aligned activities in this disclosure are based on share of turnover. Pre-contractual figures use turnover as its financial metric as a default in line with the regulatory requirements and based on the fact that complete, verifiable or up-to date data for CAPEX and/or OPEX as financial metric is even less available.

Taxonomy-aligned data is only in rare cases data reported by companies in accordance with the EU Taxonomy. The data provider has derived Taxonomy-aligned data from other available equivalent public data.

● **Does the financial product invest in fossil gas and/or nuclear energy related activities that comply with the EU Taxonomy ¹?**

- Yes:
 In fossil gas In nuclear energy
 No

The Sub-Fund does not pursue any investments in fossil gas and/or nuclear energy related activities that comply with the EU Taxonomy. Nevertheless, as result of this investment strategy, investments may occur in corporates which are also active in these activities. Further information will be provided as part of the annual reporting, if relevant.

The two graphs below show in green the minimum percentage of investments that are aligned with the EU Taxonomy. As there is no appropriate methodology to determine the Taxonomy-alignment of sovereign bonds*, the first graph shows the Taxonomy-alignment in relation to all the investments of the financial product including sovereign bonds, while the second graph shows the Taxonomy-alignment only in relation to the investments of the financial product other than sovereign bonds.

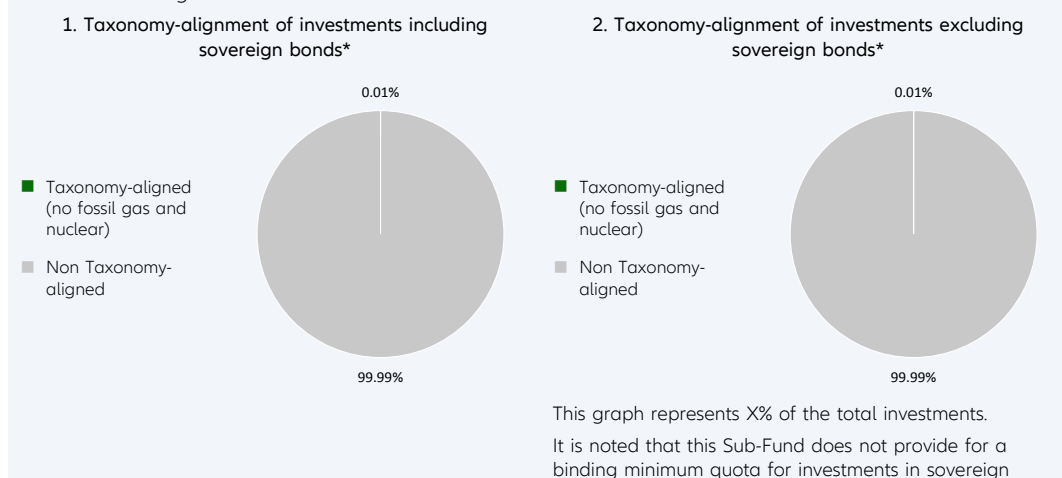

¹ Fossil gas and/or nuclear related activities will only comply with the EU Taxonomy where they contribute to limiting climate change ("climate change mitigation") and do not significantly harm any EU Taxonomy objective - see explanatory note in the left hand margin. The full criteria for fossil gas and nuclear energy economic activities that comply with the EU Taxonomy are laid down in Commission Delegated Regulation (EU) 2022/1214.

bonds. Therefore, this Sub-Fund may have (but must not have) an exposure to sovereign bonds. In the absence of a binding minimum quota for investments in sovereign bonds, this graph does not generate any additional added value compared to the left-hand graph.

* For the purpose of these graphs, 'sovereign bonds' consist of all sovereign exposures

Enabling activities directly enable other activities to make a substantial contribution to an environmental objective.

Transitional activities are activities for which low-carbon alternatives are not yet available and among others have greenhouse gas emission levels corresponding to the best performance.

● **What is the minimum share of investments in transitional and enabling activities?**

The Investment Manager does not commit to a split of minimum taxonomy alignment into transitional and enabling activities and own performance.



What is the minimum share of sustainable investments with an environmental objective that are not aligned with the EU Taxonomy?

Taxonomy-aligned investments are considered a sub-category of Sustainable Investments. If an investment is not Taxonomy-aligned since the activity is not yet covered under the EU Taxonomy or the positive contribution is not substantial enough to comply with the Taxonomy technical screening criteria, the investment can still be considered an environmentally Sustainable Investment provided it complies with all criteria. The Investment Manager does not commit to a minimum share of environmentally Sustainable Investments that are not aligned with the EU Taxonomy. The overall sustainable investment share may also include investments with an environmental objective in economic activities that do not qualify as environmentally sustainable under the EU Taxonomy, and while the Sub-Fund cannot commit to a minimum share of environmentally or socially sustainable investments, such investments may be freely allocated to within the Sub-Fund aggregated sustainable investment commitment disclosed (min. 5%).



are sustainable investments with an environmental objective that **do not take into account the criteria** for environmentally sustainable economic activities under the EU Taxonomy.



What is the minimum share of socially sustainable investments?

The Investment Manager defines Sustainable Investments based on internal research, which uses, among others, the UN Sustainable Development Goals (SDGs), as well as the objectives of the EU Taxonomy as reference frameworks. The Investment Manager does not commit to a minimum share of socially Sustainable Investments, as the SDGs contain environmental as well as social objectives. The overall sustainable investment share may also include investments with a social objective, and while the Sub-Fund cannot commit to a minimum share of environmentally or socially sustainable investments, such investments may be freely allocated to within the Sub-Fund aggregated sustainable investment commitment disclosed (min. 5%).



What investments are included under “#2 Other”, what is their purpose and are there any minimum environmental or social safeguards?

Under “#2 Other” investments into cash, Target Funds, or derivatives can be included. Derivatives might be used for efficient portfolio management (including risk hedging) and/or investment purposes, and Target Funds to benefit from a specific strategy. For those investments no environmental or social safeguards are applied.



Is a specific index designated as a reference benchmark to determine whether this financial product is aligned with the environmental and/or social characteristics that it promotes?

Yes, the Sub-Fund has assigned the ICE BofA Euro Corporate Index as a benchmark. This benchmark is a market index. The Sub-Fund will promote environmental and social characteristics by outperforming the benchmark's Weighted Average GHG Intensity

Reference benchmarks are indexes to measure whether the financial product attains the environmental or social characteristics that they promote.

- **How is the reference benchmark continuously aligned with each of the environmental or social characteristics promoted by the financial product?**

The benchmark is a market index and does not incorporate environmental or social characteristics for index construction.

- **How is the alignment of the investment strategy with the methodology of the index ensured on a continuous basis?**

The benchmark is not continuously aligned as it does not incorporate environmental or social characteristics for index construction.

- **How does the designated index differ from a relevant broad market index?**

The benchmark is a broad market index.

- **Where can the methodology used for the calculation of the designated index be found?**

Details of the Benchmark's methodology may be found at <https://www.theice.com/market-data/indices/fixed-income-indices>



Where can I find more product specific information online?

More product-specific information can be found on the website: <https://regulatory.allianzgi.com/SFDR>

Template pre-contractual disclosure for the financial products referred to in Article 8, paragraphs 1, 2 and 2a, of Regulation (EU) 2019/2088 and Article 6, first paragraph, of Regulation (EU) 2020/852

Product name:

Allianz Thematica

Legal entity identifier: 5493004ZRV2CSS15YF05

Environmental and/or social characteristics

Sustainable investment means an investment in an economic activity that contributes to an environmental or social objective, provided that the investment does not significantly harm any environmental or social objective and that the investee companies follow good governance practices.

The **EU Taxonomy** is a classification system laid down in Regulation (EU) 2020/852, establishing a list of **environmentally sustainable economic activities**. That Regulation does not include a list of socially sustainable economic activities. Sustainable investments with an environmental objective might be aligned with the Taxonomy or not.

Does this financial product have a sustainable investment objective?	
Yes	No
<input type="checkbox"/> It will make a minimum of sustainable investments with an environmental objective : ____% <input type="checkbox"/> in economic activities that qualify as environmentally sustainable under the EU Taxonomy <input type="checkbox"/> in economic activities that do not qualify as environmentally sustainable under the EU Taxonomy	<input checked="" type="checkbox"/> It promotes Environmental/Social (E/S) characteristics and while it does not have as its objective a sustainable investment, it will have a minimum proportion of 30.00% of sustainable investments <input checked="" type="checkbox"/> with an environmental objective in economic activities that qualify as environmentally sustainable under the EU Taxonomy <input checked="" type="checkbox"/> with an environmental objective in economic activities that do not qualify as environmentally sustainable under the EU Taxonomy <input checked="" type="checkbox"/> with a social objective
<input type="checkbox"/> It will make a minimum of sustainable investments with a social objective ____%	<input type="checkbox"/> It promotes E/S characteristics, but will not make any sustainable investments



What environmental and/or social characteristics are promoted by this financial product?

Allianz Thematica (the "Sub-Fund") is managed according to the Sustainability Key Performance Indicator Strategy (Absolute Threshold) ("KPI Strategy (Absolute Threshold)") which targets a specific minimum allocation into Sustainable Investments. Sustainable investments are investments in economic activities which contribute to environmental and/or social objectives, for which the Investment Managers uses as reference frameworks the UN Sustainable Development Goals (SDGs), as well as the objectives of the EU Taxonomy.

Furthermore, the Sub-Fund will limit its allocation into issuers which significantly harm environmental and/or social objectives.

In addition, sustainable minimum exclusion criteria apply.

No reference benchmark has been designated for the purpose of attaining the environmental and/or social characteristics promoted by the Sub-Fund.

● What sustainability indicators are used to measure the attainment of each of the environmental or social characteristics promoted by this financial product?

To measure the attainment of the environmental and/or social characteristics the following sustainability indicators are used and reported on, at the fiscal year end:

- The actual percentage of KPI coverage of the Sub-Fund's Portfolio (Portfolio in this respect does not comprise derivatives and instruments that are non-evaluated by nature (e. g., cash and deposits)).
- The actual weighted average sustainable investment share of Sub-Fund Assets.

Sustainability indicators measure how the environmental or social characteristics promoted by the financial product are attained.

- The actual share of investments not satisfying the Do No Significant Harm (“DNSH”) assessment of Sub-Fund Assets.
- Confirmation that Principal Adverse Impacts (PAIs) of investment decisions on sustainability factors are considered through the application of exclusion criteria.

● **What are the objectives of the sustainable investments that the financial product partially intends to make and how does the sustainable investment contribute to such objectives?**

Sustainable investments contribute to environmental and/or social objectives, for which the Investment Manager uses as reference frameworks, among others, the UN Sustainable Development Goals (SDGs), as well as the objectives of the EU Taxonomy:

1. Climate Change Mitigation
2. Climate Change Adaptation
3. Sustainable Use and Protection of Water and Marine Resources
4. Transition to a Circular Economy
5. Pollution Prevention and Control
6. Protection and Restoration of Biodiversity and Ecosystems

The assessment of the positive contribution to the environmental or social objectives is based on a proprietary framework which combines quantitative elements with qualitative inputs from internal research. The methodology applies first a quantitative breakdown of a securities issuer into its business activities. The qualitative element of the framework is an assessment if business activities contribute positively to an environmental or a social objective.

To calculate the positive contribution on the Sub-Fund level the revenue share of each issuer attributable to business activities contributing to environmental and/or social objectives is considered provided the issuer is satisfying the Do No Significant Harm (“DNSH”) and Good Governance principles, and an asset-weighted aggregation is performed as a second step. Moreover, for certain types of securities, which finance specific projects contributing to environmental or social objectives the overall investment is considered to contribute to environmental and/or social objectives, but also for these a DNSH as well as a Good Governance check for issuers is performed.

● **How do the sustainable investments that the financial product partially intends to make, not cause significant harm to any environmental or social sustainable investment objective?**

In order to ensure that Sustainable Investments do not significantly harm any other environmental and/or social objective, the Investment Manager is leveraging the PAI indicators, whereby significance thresholds have been defined to identify significantly harmful issuers. Issuers not meeting the significance threshold can be engaged for a limited time period to remediate the adverse impact. Otherwise, if the issuer does not meet the defined significance thresholds twice subsequently or in case of a failed engagement, it does not pass the DNSH assessment. Investments in securities of issuers which do not pass the DNSH assessment are not counted as sustainable investments.

● **How have the indicators for adverse impacts on sustainability factors been taken into account?**

All mandatory PAI indicators are considered either as part of the application of the exclusion criteria or through thresholds on a sectorial or absolute basis. Significance thresholds have been defined and they refer to qualitative or quantitative criteria.

Recognizing the lack of data coverage for some of the PAI indicators equivalent data points are used to assess PAI indicators when applying the DNSH assessment, when relevant, for the following indicators for corporates: share of non-renewable energy consumption and production, activities negatively affecting biodiversity-sensitive areas, emissions to water, lack of processes and compliance mechanisms to monitor compliance with UNGC principles and OECD Guidelines for Multinational Enterprises; for sovereigns: GHG Intensity and investee countries subject to social violations. In case of securities which finance specific projects contributing to environmental or social objectives equivalent data at project level might be used to ensure that Sustainable Investments do not significantly harm any other environmental and/or social objective. The Investment Manager will strive to increase data coverage for PAI indicators with low data coverage by engaging with issuers and data providers. The Investment Manager will regularly evaluate whether the availability of data has increased sufficiently to potentially include assessment of such data in the investment process.

Principal adverse impacts are the most significant negative impacts of investment decisions on sustainability factors relating to environmental, social and employee matters, respect for human rights, anti-corruption and anti-bribery matters.

- *How are the sustainable investments aligned with the OECD Guidelines for Multinational Enterprises and the UN Guiding Principles on Business and Human Rights? Details:*

The Investment Manager's sustainable minimum exclusion list screens out companies based on their involvement in controversial practices against international norms. The core normative framework consists of the Principles of the UN Global Compact, the OECD Guidelines for Multinational Enterprises and the UN Guiding Principles for Business and Human Rights. Securities issued by companies having a severe violation of these frameworks will be restricted from the investment universe.

The EU Taxonomy sets out a "do not significant harm" principle by which Taxonomy-aligned investments should not significantly harm EU Taxonomy objectives and is accompanied by specific EU criteria.

The "do not significant harm" principle applies only to those investments underlying the financial product that take into account the EU criteria for environmentally sustainable economic activities. The investments underlying the remaining portion of this financial product do not take into account the EU criteria for environmentally sustainable economic activities.

Any other sustainable investments must also not significantly harm any environmental or social objectives.



Does this financial product consider principal adverse impacts on sustainability factors?

Yes

No

The Management Company has joined the Net Zero Asset Manager Initiative and considers PAI indicators through stewardship including engagement, both are relevant to mitigate potential adverse impact as a company.

Due to the commitment to the Net Zero Asset Manager Initiative, the Management Company aims to reduce greenhouse gas emissions in partnership with asset owner clients on decarbonisation goals, consistent with an ambition to reach net zero emission by 2050 or sooner across all assets under management. As part of this objective the Management Company will set an interim target for the proportion of assets to be managed in line with the attainment of net zero emissions by 2050 or sooner.

The Sub-Fund's Investment Manager addresses PAI indicators regarding greenhouse gas emission, biodiversity, water, waste as well as social and employee matters for corporate issuers, and, where relevant, the freedom house index is applied to investments in sovereigns. PAI indicators are considered within the Investment Manager's investment process through the means of exclusions as described in the "binding elements" section of the Sub-Fund.

The data coverage for the data required for the PAI indicators is heterogenous. The data coverage related to biodiversity, water and waste is low and the related PAI indicators are considered through exclusion of securities issued by companies having a severe violation / breach of principles and guidelines such as the Principles of the United Nations Global Compact, the OECD Guidelines for Multinational Enterprises, and the United Nations Guiding Principles for Business and Human Rights on the grounds of problematic practices around human rights, labour rights, environment, and corruption issues. Therefore, the Investment Manager will strive to increase data coverage for PAI indicators with low data coverage. The Investment Manager will regularly evaluate whether the availability of data has increased sufficiently to potentially include assessment of such data in the investment process.

Additionally, the investment Manager considers PAI indicators by limiting its allocation into issuers which significantly harm environmental and/or social objectives.

The following PAI indicators are considered:

Applicable to corporate issuers

- GHG Emissions
- Carbon footprint
- GHG Intensity of investee companies
- Exposure to companies active in the fossil fuel sector
- Activities negatively affecting biodiversity-sensitive areas
- Emissions to water
- Hazardous waste ratio

- Violation of UN Global compact principles
- Lack of processes and compliance mechanisms to monitor compliance with UN Global Compact principles
- Board gender diversity
- Exposure to controversial weapons

Applicable to sovereign and supranational issuers

- Investee countries subject to social violations

The information on the PAI indicators will be available in the end-year report of the Sub-Fund.



What investment strategy does this financial product follow?

The investment strategy guides investment decisions based on factors such as investment objectives and risk tolerance.

Allianz Thematica's investment objective is to invest in global Equity Markets with a focus on theme and stock selection in accordance with the Sustainability Key Performance Indicator Strategy (Absolute Threshold) ("KPI Strategy (Absolute Threshold)"). The Sub-Fund's strategy is to target a specific minimum allocation into Sustainable Investments and limit its allocation to DNSH.

The proportion of assets which do not have a Sustainable Investment share assessment is expected to be low. Examples of instruments not having a Sustainable Investment share assessment are cash and deposits, some Target Funds, and investments for which data is not available.

The Sub-Fund's general investment approach (Sub-Fund's applicable General Asset Class Principles in combination with its individual investment restrictions) is described in the prospectus.

● What are the binding elements of the investment strategy used to select the investments to attain each of the environmental or social characteristics promoted by this financial product?

The investment strategy adheres to the following binding elements to attain the environmental and/ or social characteristics promoted:

- Min. 80% of Sub-Fund's portfolio shall be invested in companies which have been assessed according to the Sustainable Investment methodology (Portfolio in this respect does not comprise derivatives and instruments that are non-evaluated by nature (e. g., cash and deposits)).
- Min. 30% of weighted-average Sustainable Investment share at Sub Fund Assets. If the Investment Manager acquires a use of proceed security, which finance specific projects contributing to environmental or social objectives, the overall investment is considered to contribute to environmental and/or social objectives according to the Sustainable Investment methodology.
- Max. 15% of Sub-Fund assets will be invested in securities from issuers not satisfying the Do No Significant Harm ("DNSH") principles.
- Application of the following sustainable minimum exclusion criteria for direct investments:
 - securities issued by companies having a severe violation / breach of principles and guidelines such as the Principles of the United Nations Global Compact, the OECD Guidelines for Multinational Enterprises, and the United Nations Guiding Principles for Business and Human Rights on the grounds of problematic practices around human rights, labour rights, environment, and corruption,
 - securities issued by companies involved in controversial weapons (anti-personnel mines, cluster munitions, chemical weapons, biological weapons, depleted uranium, white phosphorus, and nuclear weapons),
 - securities issued by companies that derive more than 10% of their revenues from weapons, military equipment, and services,
 - securities issued by companies that derive more than 10% of their revenue from thermal coal extraction
 - securities issued by utility companies that generate more than 20% of their revenues from coal,
 - securities issued by companies involved in the production of tobacco, and securities issued by companies involved in the distribution of tobacco with more than 5% of their revenues.

Direct investments in sovereign issuers with an insufficient freedom house index score are excluded.

The sustainable minimum exclusion criteria are based on information from an external data provider and coded in pre- and post-trade compliance. The review is performed at least half yearly.

- **What is the committed minimum rate to reduce the scope of the investments considered prior to the application of that investment strategy?**

The Sub-Fund does not commit to reduce the scope of the investments by a certain minimum rate.

- **What is the policy to assess good governance practices of the investee companies?**

Good governance principles are considered by screening out companies based on their involvement in controversies around international norms corresponding to the four good governance practices: sound management structures, employee relations, remuneration of staff and tax compliance. Companies having a severe violation in either of those areas will not be investible. For certain cases, flagged issuers shall be on a watch list. These companies will appear on this watch list when the Investment Manager believes that engagement may lead to improvements or when the company is assessed to take remedial actions. Companies on the watch list remain investible unless the Investment Manager believes that the engagement or the remedial actions of the company does not lead to the desired remedy of the severe controversy.

In addition, the Sub-Fund’s Investment Manager is committed to actively encourage open dialogues with investee companies on corporate governance, proxy voting and broader sustainability issues in advance of shareholder meetings (regularly for direct investments in shares). The Sub-Fund’s Investment Manager’s approach to proxy voting and company engagement is set out in the Management Company’s Stewardship Statement.

Good governance practices include sound management structures, employee relations, remuneration of staff and tax compliance.



What is the asset allocation planned for this financial product?

Asset allocation describes the share of investments in specific assets.

Min. 80% of the Sub-Funds’ assets (excluding cash, and derivatives) are used to meet the environmental or social characteristics promoted by this Sub-Fund. A low portion of the Sub-Fund might contain assets which do not promote environmental or social characteristics. Example of such instruments are derivatives, cash and deposits, some Target Funds and investment with temporarily divergent or absent environmental, social, or good governance qualifications. Min. 30% of the Sub-Funds’ assets will be invested in Sustainable Investments. The Sub-Fund’s Investment Manager does not commit to a minimum share of sustainable investments with an environmental objective aligned with the EU Taxonomy nor to a minimum share of environmentally Sustainable Investments that are not aligned with the EU Taxonomy. The Sub-Fund’s Investment Manager does not commit to a minimum share of socially sustainable investments. While the Sub-Fund cannot commit to a minimum share of environmentally or socially sustainable investments, such investments may be freely allocated to within the Sub-Fund aggregated sustainable investment commitment disclosed (min. 30%).

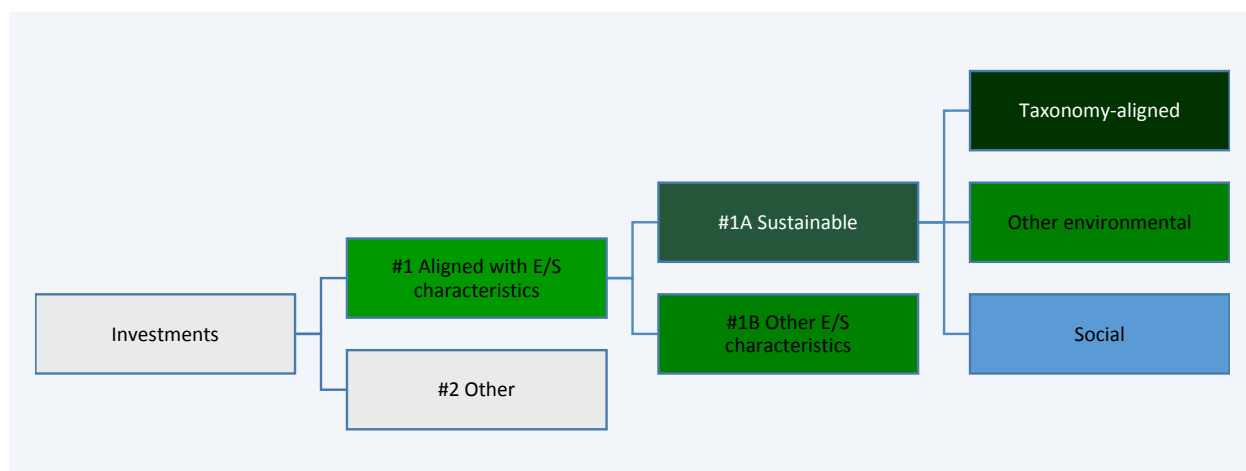

#1 Aligned with E/S characteristics includes the investments of the financial product used to attain the environmental or social characteristics promoted by the financial product.

#2 Other includes the remaining investments of the financial product which are neither aligned with the environmental or social characteristics, nor are qualified as sustainable investments.

The category **#1 Aligned with E/S characteristics** covers:

- The sub-category **#1A Sustainable** covers sustainable investments with environmental or social objectives.
- The sub-category **#1B Other E/S characteristics** covers investments aligned with the environmental or social characteristics that do not qualify as sustainable investments.

- How does the use of derivatives attain the environmental or social characteristics promoted by the financial product?

Not applicable



To what minimum extent are sustainable investments with an environmental objective aligned with the EU Taxonomy?

The Sub-Fund's Investment Manager does not commit to a minimum share of sustainable investments with an environmental objective aligned with the EU Taxonomy. The overall sustainable investment share may also include investments with an environmental objective in economic activities that qualify as environmentally sustainable under the EU Taxonomy.

- Does the financial product invest in fossil gas and/or nuclear energy related activities that comply with the EU Taxonomy ¹?

- Yes:
- In fossil gas In nuclear energy
- No

The Sub-Fund does not pursue any investments in fossil gas and/or nuclear energy related activities that comply with the EU Taxonomy. Nevertheless, as result of this investment strategy, investments may occur in corporates which are also active in these activities. Further information will be provided as part of the annual reporting, if relevant.

The two graphs below show in green the minimum percentage of investments that are aligned with the EU Taxonomy. As there is no appropriate methodology to determine the Taxonomy-alignment of sovereign bonds, the first graph shows the Taxonomy-alignment in relation to all the investments of the financial product including sovereign bonds, while the second graph shows the Taxonomy-alignment only in relation to the investments of the financial product other than sovereign bonds.*

1. Taxonomy-alignment of investments including sovereign bonds*

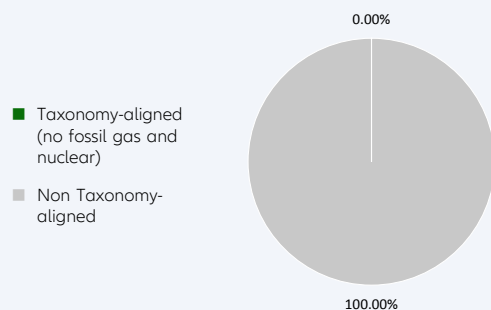

2. Taxonomy-alignment of investments excluding sovereign bonds*

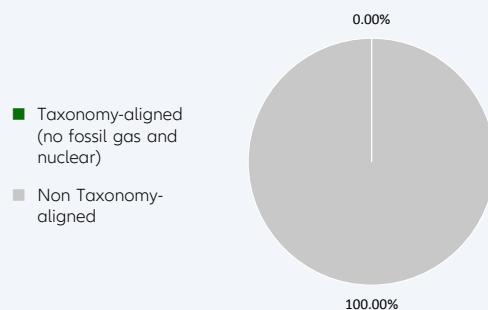

This graph represents X% of the total investments. It is noted that – due to the fact that this Sub-Fund does not provide for a minimum quota of taxonomy-aligned investments – this graph does not generate any additional added value compared to the left-hand graph.

* For the purpose of these graphs, 'sovereign bonds' consist of all sovereign exposures

- What is the minimum share of investments in transitional and enabling activities?

The Sub-Fund's Investment Manager does not commit to a split of minimum taxonomy alignment into transitional, enabling activities and own performance.

Taxonomy-aligned activities are expressed as a share of:

- **turnover** reflecting the share of revenue from green activities of investee companies
- **capital expenditure** (CapEx) showing the green investments made by investee companies, e.g. for a transition to a green economy.
- **operational expenditure** (OpEx) reflecting green operational activities of investee companies.

Enabling activities directly enable other activities to make a substantial contribution to an environmental objective.

Transitional activities are activities for which low-carbon alternatives are not yet available

¹ Fossil gas and/or nuclear related activities will only comply with the EU Taxonomy where they contribute to limiting climate change ("climate change mitigation") and do not significantly harm any EU Taxonomy objective - see explanatory note in the left hand margin. The full criteria for fossil gas and nuclear energy economic activities that comply with the EU Taxonomy are laid down in Commission Delegated Regulation (EU) 2022/1214.

and among others have greenhouse gas emission levels corresponding to the best performance.



What is the minimum share of sustainable investments with an environmental objective that are not aligned with the EU Taxonomy?

Taxonomy-aligned investments are considered a sub-category of Sustainable Investments. If an investment is not Taxonomy-aligned since the activity is not yet covered under the EU Taxonomy or the positive contribution is not substantial enough to comply with the Taxonomy technical screening criteria, the investment can still be considered an environmentally Sustainable Investment provided it complies with all criteria. The Investment Manager does not commit to a minimum share of environmentally Sustainable Investments that are not aligned with the EU Taxonomy. The overall sustainable investment share may also include investments with an environmental objective in economic activities that do not qualify as environmentally sustainable under the EU Taxonomy, and while the Sub-Fund cannot commit to a minimum share of environmentally or socially sustainable investments, such investments may be freely allocated to within the Sub-Fund aggregated sustainable investment commitment disclosed (min 30%).



are sustainable investments with an environmental objective that **do not take into account the criteria** for environmentally sustainable economic activities under the EU Taxonomy.



What is the minimum share of socially sustainable investments?

The Investment Manager defines Sustainable Investments based on internal research, which uses, among others, the UN Sustainable Development Goals (SDGs), as well as the objectives of the EU Taxonomy as reference frameworks. The Investment Manager does not commit to a minimum share of socially Sustainable Investments, as the SDGs contain environmental as well as social objectives. The overall sustainable investment share may also include investments with a social objective,, and while the Sub-Fund cannot commit to a minimum share of environmentally or socially sustainable investments, such investments may be freely allocated to within the Sub-Fund aggregated sustainable investment commitment disclosed (min 30%).



What investments are included under “#2 Other”, what is their purpose and are there any minimum environmental or social safeguards?

Under “#2 Other” investments into cash, Target Funds, or derivatives can be included. Derivatives might be used for efficient portfolio management (including risk hedging) and/or investment purposes, and Target Funds to benefit from a specific strategy. For those investments no environmental or social safeguards are applied.



Is a specific index designated as a reference benchmark to determine whether this financial product is aligned with the environmental and/or social characteristics that it promotes?

No reference benchmark has been designated for the purpose of attaining the environmental and/or social characteristics promoted by the Sub-Fund.

Reference benchmarks are indexes to measure whether the financial product attains the environmental or social characteristics that they promote.

- How is the reference benchmark continuously aligned with each of the environmental or social characteristics promoted by the financial product?

Not applicable

- How is the alignment of the investment strategy with the methodology of the index ensured on a continuous basis?

Not applicable

- How does the designated index differ from a relevant broad market index?
Not applicable
- Where can the methodology used for the calculation of the designated index be found?
Not applicable



Where can I find more product specific information online?

More product-specific information can be found on the website: <https://regulatory.allianzgi.com/SFDR>

Template pre-contractual disclosure for the financial products referred to in Article 8, paragraphs 1, 2 and 2a, of Regulation (EU) 2019/2088 and Article 6, first paragraph, of Regulation (EU) 2020/852

Product name:

Allianz Total Return Asian Equity

Legal entity identifier: 549300K61J05QBE7CP78

Environmental and/or social characteristics

Sustainable investment means an investment in an economic activity that contributes to an environmental or social objective, provided that the investment does not significantly harm any environmental or social objective and that the investee companies follow good governance practices.

The EU Taxonomy is a classification system laid down in Regulation (EU) 2020/852, establishing a list of **environmentally sustainable economic activities**. That Regulation does not include a list of socially sustainable economic activities. Sustainable investments with an environmental objective might be aligned with the Taxonomy or not.

Does this financial product have a sustainable investment objective?

<input checked="" type="radio"/> <input checked="" type="radio"/> Yes		<input checked="" type="radio"/> <input type="radio"/> No	
<input type="checkbox"/> It will make a minimum of sustainable investments with an environmental objective : ____%	<input checked="" type="checkbox"/> It promotes Environmental/Social (E/S) characteristics and while it does not have as its objective a sustainable investment, it will have a minimum proportion of 2.00% of sustainable investments	<input checked="" type="checkbox"/> with an environmental objective in economic activities that qualify as environmentally sustainable under the EU Taxonomy	<input checked="" type="checkbox"/> with an environmental objective in economic activities that do not qualify as environmentally sustainable under the EU Taxonomy
<input type="checkbox"/> in economic activities that qualify as environmentally sustainable under the EU Taxonomy	<input checked="" type="checkbox"/> with a social objective	<input type="checkbox"/> It will make a minimum of sustainable investments with a social objective ____%	<input type="checkbox"/> It promotes E/S characteristics, but will not make any sustainable investments
<input type="checkbox"/> in economic activities that do not qualify as environmentally sustainable under the EU Taxonomy			



What environmental and/or social characteristics are promoted by this financial product?

Allianz Total Return Asian Equity (the "Sub-Fund") is managed according to the Sustainability Key Performance Indicator Strategy (Relative) ("KPI Strategy (Relative)") which addresses greenhouse gas (GHG) Intensity. The "Sustainability KPI" measures the GHG Intensity defined by the weighted average intensity of greenhouse gas emissions based on company's annual sales ("GHG Intensity").

GHG Intensity will be addressed by outperforming the Weighted Average GHG Intensity against its benchmark.

In addition, sustainable minimum exclusion criteria apply.

A reference benchmark has been designated for the purpose of attaining the environmental and/or social characteristics promoted by the Sub-Fund.

● What sustainability indicators are used to measure the attainment of each of the environmental or social characteristics promoted by this financial product?

To measure the attainment of the environmental and/or social characteristics the following sustainability indicators are used and reported on, at the fiscal year end:

- The actual percentage of KPI coverage of the Sub-Fund's Portfolio (Portfolio in this respect does not comprise derivatives and instruments that are non-evaluated by nature (e. g., cash and deposits)).
- The actual weighted average GHG Intensity portfolio vs weighted average GHG Intensity of the benchmark.

Sustainability indicators measure how the environmental or social characteristics promoted by the financial product are attained.

- Confirmation that Principal adverse impacts (PAIs) of investment decisions on sustainability factors are considered through the application of exclusion criteria.

- **What are the objectives of the sustainable investments that the financial product partially intends to make and how does the sustainable investment contribute to such objectives?**

Sustainable investments contribute to environmental and/or social objectives, for which the Investment Manager uses as reference frameworks, among others, the UN Sustainable Development Goals (SDGs), as well as the objectives of the EU Taxonomy:

1. Climate Change Mitigation
2. Climate Change Adaptation
3. Sustainable Use and Protection of Water and Marine Resources
4. Transition to a Circular Economy
5. Pollution Prevention and Control
6. Protection and Restoration of Biodiversity and Ecosystems

The assessment of the positive contribution to the environmental or social objectives is based on a proprietary framework which combines quantitative elements with qualitative inputs from internal research. The methodology applies first a quantitative breakdown of a securities issuer into its business activities. The qualitative element of the framework is an assessment if business activities contribute positively to an environmental or a social objective.

To calculate the positive contribution on the Sub-Fund level the revenue share of each issuer attributable to business activities contributing to environmental and/or social objectives is considered provided the issuer is satisfying the Do No Significant Harm ("DNSH") and Good Governance principles, and an asset-weighted aggregation is performed as a second step. Moreover, for certain types of securities, which finance specific projects contributing to environmental or social objectives the overall investment is considered to contribute to environmental and/or social objectives, but also for these a DNSH as well as a Good Governance check for issuers is performed.

- **How do the sustainable investments that the financial product partially intends to make, not cause significant harm to any environmental or social sustainable investment objective?**

In order to ensure that Sustainable Investments do not significantly harm any other environmental and/or social objective, the Investment Manager is leveraging the PAI indicators, whereby significance thresholds have been defined to identify significantly harmful issuers. Issuers not meeting the significance threshold can be engaged for a limited time period to remediate the adverse impact. Otherwise, if the issuer does not meet the defined significance thresholds twice subsequently or in case of a failed engagement, it does not pass the DNSH assessment. Investments in securities of issuers which do not pass the DNSH assessment are not counted as sustainable investments.

- *How have the indicators for adverse impacts on sustainability factors been taken into account?*

All mandatory PAI indicators are considered either as part of the application of the exclusion criteria or through thresholds on a sectorial or absolute basis. Significance thresholds have been defined and they refer to qualitative or quantitative criteria.

Recognizing the lack of data coverage for some of the PAI indicators equivalent data points are used to assess PAI indicators when applying the DNSH assessment, when relevant, for the following indicators for corporates: share of non-renewable energy consumption and production, activities negatively affecting biodiversity-sensitive areas, emissions to water, lack of processes and compliance mechanisms to monitor compliance with UNGC principles and OECD Guidelines for Multinational Enterprises; for sovereigns: GHG Intensity and investee countries subject to social violations. In case of securities which finance specific projects contributing to environmental or social objectives equivalent data at project level might be used to ensure that Sustainable Investments do not significantly harm any other environmental and/or social objective. The Investment Manager will strive to increase data coverage for PAI indicators with low data coverage by engaging with issuers and data providers. The Investment Manager will regularly evaluate whether the availability of data has increased sufficiently to potentially include assessment of such data in the investment process.

Principal adverse impacts are the most significant negative impacts of investment decisions on sustainability factors relating to environmental, social and employee matters, respect for human rights, anti-corruption and anti-bribery matters.

- *How are the sustainable investments aligned with the OECD Guidelines for Multinational Enterprises and the UN Guiding Principles on Business and Human Rights? Details:*

The Investment Manager's sustainable minimum exclusion list screens out companies based on their involvement in controversial practices against international norms. The core normative framework consists of the Principles of the UN Global Compact, the OECD Guidelines for Multinational Enterprises and the UN Guiding Principles for Business and Human Rights. Securities issued by companies having a severe violation of these frameworks will be restricted from the investment universe.

The EU Taxonomy sets out a "do not significant harm" principle by which Taxonomy-aligned investments should not significantly harm EU Taxonomy objectives and is accompanied by specific EU criteria.

The "do not significant harm" principle applies only to those investments underlying the financial product that take into account the EU criteria for environmentally sustainable economic activities. The investments underlying the remaining portion of this financial product do not take into account the EU criteria for environmentally sustainable economic activities.

Any other sustainable investments must also not significantly harm any environmental or social objectives.



Does this financial product consider principal adverse impacts on sustainability factors?

Yes

No

The Management Company has joined the Net Zero Asset Manager Initiative and considers PAI indicators through stewardship including engagement, both are relevant to mitigate potential adverse impact as a company.

Due to the commitment to the Net Zero Asset Manager Initiative, the Management Company aims to reduce greenhouse gas emissions in partnership with asset owner clients on decarbonisation goals, consistent with an ambition to reach net zero emission by 2050 or sooner across all assets under management. As part of this objective the Management Company will set an interim target for the proportion of assets to be managed in line with the attainment of net zero emissions by 2050 or sooner.

The Sub-Fund's Investment Manager addresses PAI indicators regarding greenhouse gas emission, biodiversity, water, waste as well as social and employee matters for corporate issuers, and, where relevant, the freedom house index is applied to investments in sovereigns. PAI indicators are considered within the Investment Manager's investment process through the means of exclusions as described in the "binding elements" section of the Sub-Fund.

The data coverage for the data required for the PAI indicators is heterogenous. The data coverage related to biodiversity, water and waste is low and the related PAI indicators are considered through exclusion of securities issued by companies having a severe violation / breach of principles and guidelines such as the Principles of the United Nations Global Compact, the OECD Guidelines for Multinational Enterprises, and the United Nations Guiding Principles for Business and Human Rights on the grounds of problematic practices around human rights, labour rights, environment, and corruption issues. Therefore, the Investment Manager will strive to increase data coverage for PAI indicators with low data coverage. The Investment Manager will regularly evaluate whether the availability of data has increased sufficiently to potentially include assessment of such data in the investment process.

Additionally, the Investment manager considers GHG related PAI indicators by outperforming the Weighted Average GHG Intensity against its benchmark.

The following PAI indicators are considered:

Applicable to corporate issuers

- GHG Emissions
- Carbon footprint
- GHG Intensity of investee companies
- Exposure to companies active in the fossil fuel sector
- Activities negatively affecting biodiversity-sensitive areas
- Emissions to water
- Hazardous waste ratio

- Violation of UN Global compact principles
- Lack of processes and compliance mechanisms to monitor compliance with UN Global Compact principles
- Board gender diversity
- Exposure to controversial weapons

Applicable to sovereign and supranational issuers

- Investee countries subject to social violations

The information on the PAI indicators will be available in the end-year report of the Sub-Fund.



The investment strategy guides investment decisions based on factors such as investment objectives and risk tolerance.

What investment strategy does this financial product follow?

Allianz Total Return Asian Equity's investment objective is to invest in the equity markets of the Republic of Korea, Taiwan, Thailand, Hong Kong, Malaysia, Indonesia, the Philippines, Singapore and/or the PRC in accordance with the Sustainability Key Performance Indicator Strategy (Relative) ("KPI Strategy (Relative)").

The Sub-Fund's strategy is to outperform the Weighted Average GHG Intensity against its benchmark. The outperformance is determined as the excess between the Sub-Fund's weighted average GHG Intensity and the Sub-Fund's benchmark Weighted Average GHG Intensity.

The weighted average GHG Intensity is the weighted average of the Sub-Fund's GHG Intensity (in tCO₂e per Millions of sales). Sales represent company's annual sales. This ratio of GHG normalized by Sales facilitates comparison between companies of different sizes. The ratio is in tCO₂e per Millions of sales. The metric allows comparing weighted average GHG Intensities of different portfolios to identify portfolios comprised of more GHG-efficient issuers in terms of the issuer's sales. The portfolio weights (and benchmark or universe weights) are rebased such that only issuers with GHG emissions data available are considered in the calculation. GHG represents a respective issuer's greenhouse gas emissions. To determine the GHG Intensity of a company issuer, GHG Intensity data from third party data providers will be used. The GHG intensity is analysed by the Investment Manager and is considered within the securities selection process in order to meet the Sub-Fund Investment objective.

The proportion of assets which do not have a GHG intensity assessment is expected to be low. Examples of instruments not having a GHG intensity assessment are cash and deposits, some Target Funds, and investments for which the GHG intensity is deemed to be not appropriate and/or data is not available.

The Sub-Fund's general investment approach (Sub-Fund's applicable General Asset Class Principles in combination with its individual investment restrictions) is described in the prospectus.

● What are the binding elements of the investment strategy used to select the investments to attain each of the environmental or social characteristics promoted by this financial product?

The binding elements are:

- Min. 80% KPI coverage of the Sub-Fund's Portfolio (Portfolio in this respect does not comprise derivatives and instruments that are non-evaluated by nature (e. g., cash and deposits)).
- Min. 20% outperformance of benchmark in terms of Weighted Average GHG Intensity.
- Application of the following sustainable minimum exclusion criteria for direct investments:
 - securities issued by companies having a severe violation / breach of principles and guidelines such as the Principles of the United Nations Global Compact, the OECD Guidelines for Multinational Enterprises, and the United Nations Guiding Principles for Business and Human Rights on the grounds of problematic practices around human rights, labour rights, environment, and corruption issues,
 - securities issued by companies involved in controversial weapons (anti-personnel mines, cluster munitions, chemical weapons, biological weapons, depleted uranium, white phosphorus, and nuclear weapons),
 - securities issued by companies that derive more than 10% of their revenues from weapons, military equipment, and services,
 - securities issued by companies that derive more than 10% of their revenue from thermal coal extraction,
 - securities issued by utility companies that generate more than 20% of their revenues from coal,

- securities issued by companies involved in the production of tobacco, and securities issued by companies involved in the distribution of tobacco with more than 5% of their revenues.

Direct investments in sovereign issuers with an insufficient freedom house index score are excluded.

The sustainable minimum exclusion criteria are based on information from an external data provider and coded in pre- and post-trade compliance. The review is performed at least half yearly.

- **What is the committed minimum rate to reduce the scope of the investments considered prior to the application of that investment strategy?**

The Sub-Fund does not commit to reduce the scope of the investments by a certain minimum rate.

- **What is the policy to assess good governance practices of the investee companies?**

Good governance principles are considered by screening out companies based on their involvement in controversies around international norms corresponding to the four good governance practices: sound management structures, employee relations, remuneration of staff and tax compliance. Companies having a severe violation in either of those areas will not be investible. For certain cases, flagged issuers shall be on a watch list. These companies will appear on this watch list when the Investment Manager believes that engagement may lead to improvements or when the company is assessed to take remedial actions. Companies on the watch list remain investible unless the Investment Manager believes that the engagement or the remedial actions of the company does not lead to the desired remedy of the severe controversy.

In addition, the Sub-Fund's Investment Manager is committed to actively encourage open dialogues with investee companies on corporate governance, proxy voting and broader sustainability issues in advance of shareholder meetings (regularly for direct investments in shares). The Sub-Fund's Investment Manager's approach to proxy voting and company engagement is set out in the Management Company's Stewardship Statement.

Good governance practices include sound management structures, employee relations, remuneration of staff and tax compliance.



What is the asset allocation planned for this financial product?

Asset allocation describes the share of investments in specific assets.

Min. 80% of the Sub-Funds' assets (excluding cash, and derivatives) are used to meet the environmental or social characteristics promoted by this Sub-Fund. A low portion of the Sub-Fund might contain assets which do not promote environmental or social characteristics. Examples of such instruments are derivatives, cash and deposits, some Target Funds and investment with temporarily divergent or absent environmental, social, or good governance qualifications. Min. 2% of the Sub-Funds' assets will be invested in Sustainable Investments. The Sub-Fund's Investment Manager does not commit to a minimum share of sustainable investments with an environmental objective aligned with the EU Taxonomy nor to a minimum share of environmentally Sustainable Investments that are not aligned with the EU Taxonomy. The Sub-Fund's Investment Manager does not commit to a minimum share of socially sustainable investments. While the Sub-Fund cannot commit to a minimum share of environmentally or socially sustainable investments, such investments may be freely allocated to within the Sub-Fund aggregated sustainable investment commitment disclosed (min. 2%).

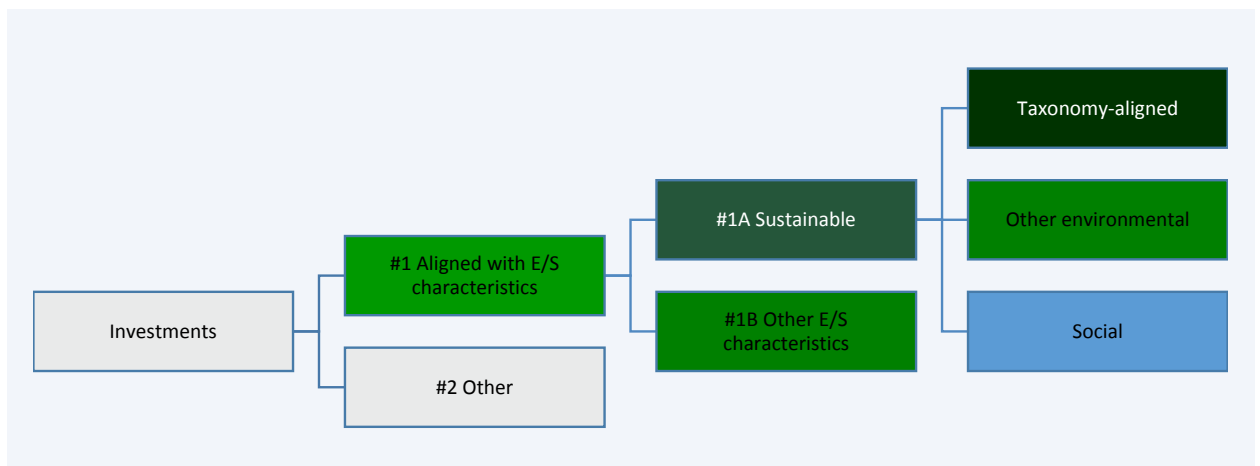

#1 Aligned with E/S characteristics includes the investments of the financial product used to attain the environmental or social characteristics promoted by the financial product.

#2 Other includes the remaining investments of the financial product which are neither aligned with the environmental or social characteristics, nor are qualified as sustainable investments.

The category #1 Aligned with E/S characteristics covers:

- The sub-category #1A Sustainable covers sustainable investments with environmental or social objectives.
- The sub-category #1B Other E/S characteristics covers investments aligned with the environmental or social characteristics that do not qualify as sustainable investments.

● How does the use of derivatives attain the environmental or social characteristics promoted by the financial product?

Not applicable



To what minimum extent are sustainable investments with an environmental objective aligned with the EU Taxonomy?

The Sub-Fund’s Investment Manager does not commit to a minimum share of sustainable investments with an environmental objective aligned with the EU Taxonomy. The overall sustainable investment share may also include investments with an environmental objective in economic activities that qualify as environmentally sustainable under the EU Taxonomy.

● Does the financial product invest in fossil gas and/or nuclear energy related activities that comply with the EU Taxonomy ¹?

- Yes:
 In fossil gas In nuclear energy

No

The Sub-Fund does not pursue any investments in fossil gas and/or nuclear energy related activities that comply with the EU Taxonomy. Nevertheless, as result of this investment strategy, investments may occur in corporates which are also active in these activities. Further information will be provided as part of the annual reporting, if relevant.

The two graphs below show in green the minimum percentage of investments that are aligned with the EU Taxonomy. As there is no appropriate methodology to determine the Taxonomy-alignment of sovereign bonds*, the first graph shows the Taxonomy-alignment in relation to all the investments of the financial product including sovereign bonds, while the second graph shows the Taxonomy-alignment only in relation to the investments of the financial product other than sovereign bonds.

1. Taxonomy-alignment of investments including sovereign bonds*

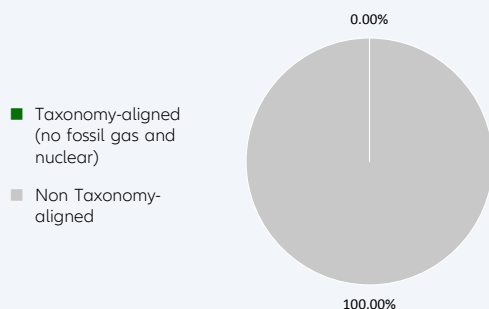

2. Taxonomy-alignment of investments excluding sovereign bonds*

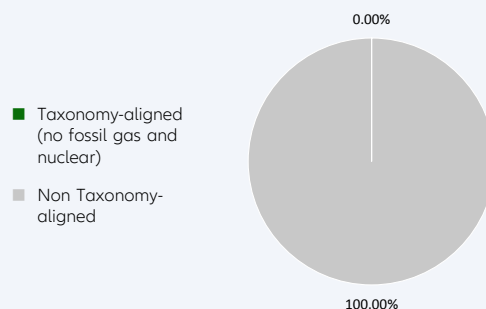

This graph represents X% of the total investments. It is noted that – due to the fact that this Sub-Fund does not provide for a minimum quota of taxonomy-aligned investments – this graph does not generate any additional added value compared to the left-hand graph.

* For the purpose of these graphs, 'sovereign bonds' consist of all sovereign exposures

● What is the minimum share of investments in transitional and enabling activities?

The Sub-Fund’s Investment Manager does not commit to a split of minimum taxonomy alignment into transitional, enabling activities and own performance.

Taxonomy-aligned activities are expressed as a share of:
 - **turnover** reflecting the share of revenue from green activities of investee companies
 - **capital expenditure** (CapEx) showing the green investments made by investee companies, e.g. for a transition to a green economy.
 - **operational expenditure** (OpEx) reflecting green operational activities of investee companies.

Enabling activities directly enable other activities to make a substantial contribution

¹ Fossil gas and/or nuclear related activities will only comply with the EU Taxonomy where they contribute to limiting climate change ("climate change mitigation") and do not significantly harm any EU Taxonomy objective - see explanatory note in the left hand margin. The full criteria for fossil gas and nuclear energy economic activities that comply with the EU Taxonomy are laid down in Commission Delegated Regulation (EU) 2022/1214.

to an environmental objective.

Transitional activities are activities for which low-carbon alternatives are not yet available and among others have greenhouse gas emission levels corresponding to the best performance.



What is the minimum share of sustainable investments with an environmental objective that are not aligned with the EU Taxonomy?

Taxonomy-aligned investments are considered a sub-category of Sustainable Investments. If an investment is not Taxonomy-aligned since the activity is not yet covered under the EU Taxonomy or the positive contribution is not substantial enough to comply with the Taxonomy technical screening criteria, the investment can still be considered an environmentally Sustainable Investment provided it complies with all criteria. The Investment Manager does not commit to a minimum share of environmentally Sustainable Investments that are not aligned with the EU Taxonomy. The overall sustainable investment share may also include investments with an environmental objective in economic activities that do not qualify as environmentally sustainable under the EU Taxonomy, and while the Sub-Fund cannot commit to a minimum share of environmentally or socially sustainable investments, such investments may be freely allocated to within the Sub-Fund aggregated sustainable investment commitment disclosed (min. 2%).



are sustainable investments with an environmental objective that **do not take into account the criteria** for environmentally sustainable economic activities under the EU Taxonomy.



What is the minimum share of socially sustainable investments?

The Investment Manager defines Sustainable Investments based on internal research, which uses, among others, the UN Sustainable Development Goals (SDGs), as well as the objectives of the EU Taxonomy as reference frameworks. The Investment Manager does not commit to a minimum share of socially Sustainable Investments, as the SDGs contain environmental as well as social objectives. The overall sustainable investment share may also include investments with a social objective, and while the Sub-Fund cannot commit to a minimum share of environmentally or socially sustainable investments, such investments may be freely allocated to within the Sub-Fund aggregated sustainable investment commitment disclosed (min 2%).



What investments are included under “#2 Other”, what is their purpose and are there any minimum environmental or social safeguards?

Under “#2 Other” investments into cash, Target Funds, or derivatives can be included. Derivatives might be used for efficient portfolio management (including risk hedging) and/or investment purposes, and Target Funds to benefit from a specific strategy. For those investments no environmental or social safeguards are applied.



Is a specific index designated as a reference benchmark to determine whether this financial product is aligned with the environmental and/or social characteristics that it promotes?

Yes, the Sub-Fund has assigned the MSCI AC Asia Excl. Japan Total Return Net as a benchmark. This benchmark is a market index. The Sub-Fund will promote environmental and social characteristics by outperforming the benchmark's Weighted Average GHG Intensity

Reference benchmarks are indexes to measure whether the financial product attains the environmental or social

● How is the reference benchmark continuously aligned with each of the environmental or social characteristics promoted by the financial product?

The benchmark is a market index and does not incorporate environmental or social characteristics for index construction.

characteristics that they promote.

- **How is the alignment of the investment strategy with the methodology of the index ensured on a continuous basis?**

The benchmark is not continuously aligned as it does not incorporate environmental or social characteristics for index construction.

- **How does the designated index differ from a relevant broad market index?**

The benchmark is a broad market index.

- **Where can the methodology used for the calculation of the designated index be found?**

Details of the Benchmark's methodology may be found at <https://www.msci.com/documents/10199/9995ff24-2232-4373-97b5-f5cb276d3b93> or at www.msci.com



Where can I find more product specific information online?

More product-specific information can be found on the website: <https://regulatory.allianzgi.com/SFDR>

Template pre-contractual disclosure for the financial products referred to in Article 8, paragraphs 1, 2 and 2a, of Regulation (EU) 2019/2088 and Article 6, first paragraph, of Regulation (EU) 2020/852

Product name:

Allianz Treasury Short Term Plus Euro

Legal entity identifier: 549300RZL4PEFWYY4H53

Environmental and/or social characteristics

Sustainable investment means an investment in an economic activity that contributes to an environmental or social objective, provided that the investment does not significantly harm any environmental or social objective and that the investee companies follow good governance practices.

The **EU Taxonomy** is a classification system laid down in Regulation (EU) 2020/852, establishing a list of **environmentally sustainable economic activities**. That Regulation does not include a list of socially sustainable economic activities. Sustainable investments with an environmental objective might be aligned with the Taxonomy or not.

Does this financial product have a sustainable investment objective?

<input checked="" type="radio"/> <input checked="" type="radio"/> Yes		<input checked="" type="radio"/> <input type="radio"/> No	
<input type="checkbox"/> It will make a minimum of sustainable investments with an environmental objective: ___%	<input type="checkbox"/> in economic activities that qualify as environmentally sustainable under the EU Taxonomy	<input checked="" type="checkbox"/> It promotes Environmental/Social (E/S) characteristics and while it does not have as its objective a sustainable investment, it will have a minimum proportion of 5.00% of sustainable investments	<input checked="" type="checkbox"/> with an environmental objective in economic activities that qualify as environmentally sustainable under the EU Taxonomy
<input type="checkbox"/> in economic activities that do not qualify as environmentally sustainable under the EU Taxonomy	<input type="checkbox"/> It will make a minimum of sustainable investments with a social objective ___%	<input checked="" type="checkbox"/> with an environmental objective in economic activities that do not qualify as environmentally sustainable under the EU Taxonomy	<input checked="" type="checkbox"/> with a social objective
<input type="checkbox"/> It will make a minimum of sustainable investments with a social objective ___%		<input type="checkbox"/> It promotes E/S characteristics, but will not make any sustainable investments	



What environmental and/or social characteristics are promoted by this financial product?

Allianz Treasury Short Term Plus Euro (the "Sub-Fund") promotes environmental, social, human rights, governance, and business behaviour factors (this domain does not apply for sovereigns issued by a Sovereign Entity) through integration of a best-in-class approach into the Sub-Fund's investment process. This encompasses the evaluation of corporate or sovereign issuers based on an SRI Rating which is used to construct the portfolio.

In addition, sustainable minimum exclusion criteria apply.

No reference benchmark has been designated for the purpose of attaining the environmental and/or social characteristics promoted by the Sub-Fund.

● What sustainability indicators are used to measure the attainment of each of the environmental or social characteristics promoted by this financial product?

To measure the attainment of the environmental and/or social characteristics the following sustainability indicators are used and reported on, at the fiscal year end:

- The actual percentage of the Sub-Fund's Portfolio (Portfolio in this respect does not comprise non-rated derivatives and instruments that are non-rated by nature (e. g., cash and deposits)) assets invested in best-in-class issuers (issuers with a minimum SRI Rating of 1 out of a scale from 0-4; 0 being the worst rating and 4 the best rating).
- Confirmation that Principal Adverse Impacts (PAIs) of investment decisions on sustainability factors are considered through the application of exclusion criteria.

Sustainability indicators measure how the environmental or social characteristics promoted by the financial product are attained.

- **What are the objectives of the sustainable investments that the financial product partially intends to make and how does the sustainable investment contribute to such objectives?**

Sustainable investments contribute to environmental and/or social objectives, for which the Investment Manager uses as reference frameworks, among others, the UN Sustainable Development Goals (SDGs), as well as the objectives of the EU Taxonomy:

1. Climate Change Mitigation
2. Climate Change Adaptation
3. Sustainable Use and Protection of Water and Marine Resources
4. Transition to a Circular Economy
5. Pollution Prevention and Control
6. Protection and Restoration of Biodiversity and Ecosystems

The assessment of the positive contribution to the environmental or social objectives is based on a proprietary framework which combines quantitative elements with qualitative inputs from internal research. The methodology applies first a quantitative breakdown of a securities issuer into its business activities. The qualitative element of the framework is an assessment if business activities contribute positively to an environmental or a social objective.

To calculate the positive contribution on the Sub-Fund level the revenue share of each issuer attributable to business activities contributing to environmental and/or social objectives is considered provided the issuer is satisfying the Do No Significant Harm ("DNSH") and Good Governance principles, and an asset-weighted aggregation is performed as a second step. Moreover, for certain types of securities, which finance specific projects contributing to environmental or social objectives the overall investment is considered to contribute to environmental and/or social objectives, but also for these a DNSH as well as a Good Governance check for issuers is performed.

- **How do the sustainable investments that the financial product partially intends to make, not cause significant harm to any environmental or social sustainable investment objective?**

In order to ensure that Sustainable Investments do not significantly harm any other environmental and/or social objective, the Investment Manager is leveraging the PAI indicators, whereby significance thresholds have been defined to identify significantly harmful issuers. Issuers not meeting the significance threshold can be engaged for a limited time period to remediate the adverse impact. Otherwise, if the issuer does not meet the defined significance thresholds twice subsequently or in case of a failed engagement, it does not pass the DNSH assessment. Investments in securities of issuers which do not pass the DNSH assessment are not counted as sustainable investments.

- *How have the indicators for adverse impacts on sustainability factors been taken into account?*

All mandatory PAI indicators are considered either as part of the application of the exclusion criteria or through thresholds on a sectorial or absolute basis. Significance thresholds have been defined and they refer to qualitative or quantitative criteria.

Recognizing the lack of data coverage for some of the PAI indicators equivalent data points are used to assess PAI indicators when applying the DNSH assessment, when relevant, for the following indicators for corporates: share of non-renewable energy consumption and production, activities negatively affecting biodiversity-sensitive areas, emissions to water, lack of processes and compliance mechanisms to monitor compliance with UNGC principles and OECD Guidelines for Multinational Enterprises; for sovereigns: GHG Intensity and investee countries subject to social violations. In case of securities which finance specific projects contributing to environmental or social objectives equivalent data at project level might be used to ensure that Sustainable Investments do not significantly harm any other environmental and/or social objective. The Investment Manager will strive to increase data coverage for PAI indicators with low data coverage by engaging with issuers and data providers. The Investment Manager will regularly evaluate whether the availability of data has increased sufficiently to potentially include assessment of such data in the investment process.

- *How are the sustainable investments aligned with the OECD Guidelines for Multinational Enterprises and the UN Guiding Principles on Business and Human Rights? Details:*

The Investment Manager's sustainable minimum exclusion list screens out companies based on their involvement in controversial practices against international norms. The core normative framework consists of the Principles of the UN Global Compact, the OECD Guidelines for Multinational Enterprises

Principal adverse impacts are the most significant negative impacts of investment decisions on sustainability factors relating to environmental, social and employee matters, respect for human rights, anti-corruption and anti-bribery matters.

and the UN Guiding Principles for Business and Human Rights. Securities issued by companies having a severe violation of these frameworks will be restricted from the investment universe.

The EU Taxonomy sets out a “do not significant harm” principle by which Taxonomy-aligned investments should not significantly harm EU Taxonomy objectives and is accompanied by specific EU criteria.

The “do not significant harm” principle applies only to those investments underlying the financial product that take into account the EU criteria for environmentally sustainable economic activities. The investments underlying the remaining portion of this financial product do not take into account the EU criteria for environmentally sustainable economic activities.

Any other sustainable investments must also not significantly harm any environmental or social objectives.



Does this financial product consider principal adverse impacts on sustainability factors?

Yes

No

The Management Company has joined the Net Zero Asset Manager Initiative and considers PAI indicators through stewardship including engagement, both are relevant to mitigate potential adverse impact as a company.

Due to the commitment to the Net Zero Asset Manager Initiative, the Management Company aims to reduce greenhouse gas emissions in partnership with asset owner clients on decarbonisation goals, consistent with an ambition to reach net zero emission by 2050 or sooner across all assets under management. As part of this objective the Management Company will set an interim target for the proportion of assets to be managed in line with the attainment of net zero emissions by 2050 or sooner.

The Sub-Fund’s Investment Manager considers PAI indicators regarding greenhouse gas emission, biodiversity, water, waste as well as social and employee matters for corporate issuers, and, where relevant, the freedom house index is applied to investments in sovereigns. PAI indicators are considered within the Investment Manager’s investment process through the means of exclusions as described in the “binding elements” section of the Sub-Fund.

The data coverage for the data required for the PAI indicators is heterogenous. The data coverage related to biodiversity, water and waste is low and the related PAI indicators are considered through exclusion of securities issued by companies having a severe violation / breach of principles and guidelines such as the Principles of the United Nations Global Compact, the OECD Guidelines for Multinational Enterprises, and the United Nations Guiding Principles for Business and Human Rights on the grounds of problematic practices around human rights, labour rights, environment, and corruption issues. Therefore, the Investment Manager will strive to increase data coverage for PAI indicators with low data coverage. The Investment Manager will regularly evaluate whether the availability of data has increased sufficiently to potentially include assessment of such data in the investment process.

Additionally, PAI indicators are, among other sustainability factors, applied to derive the SRI Rating. The SRI Rating is used for the portfolio construction.

The following PAI indicators are considered:

Applicable to corporate issuers

- GHG Emissions
- Carbon footprint
- GHG Intensity of investee companies
- Exposure to companies active in the fossil fuel sector
- Activities negatively affecting biodiversity-sensitive areas
- Emissions to water
- Hazardous waste ratio
- Violation of UN Global compact principles
- Lack of processes and compliance mechanisms to monitor compliance with UN Global Compact principles
- Board gender diversity
- Exposure to controversial weapons

Applicable to sovereign and supranational issuers

- Investee countries subject to social violations

The information on the PAI indicators will be available in the end-year report of the Sub-Fund.



The investment strategy guides investment decisions based on factors such as investment objectives and risk tolerance.

What investment strategy does this financial product follow?

Allianz Treasury Short Term Plus Euro's investment objective is to invest in Debt Securities with Euro Exposure of Eurozone Bond Markets in accordance with the Sustainable and Responsible Investment Strategy (SRI Strategy).

As part of the SRI best-in-class approach, the Sub-Fund takes environmental, social, human rights, governance, and business behaviour factors into account as follows:

- The aforesaid sustainability factors are analysed through SRI Research by the Investment Manager in order to assess how sustainable development and long-term issues are taken into account in the strategy of an issuer. SRI Research means the overall process of identifying potential risks as well as potential opportunities of an investment in securities of an issuer related to the analysis of sustainability factors. SRI Research data combines external research data (which might have some limitations) with internal analyses.
- Based on a combination of the results of the external and/or internal analyses of the sustainability factors, an internal rating is derived monthly (SRI Rating) and is afterwards assigned to a corporate or sovereign issuer.

This internal SRI Rating is used to rank and select or weight securities for the portfolio construction.

The Sub-Fund's general investment approach (Sub-Fund's applicable General Asset Class Principles in combination with its individual investment restrictions) is described in the prospectus.

● What are the binding elements of the investment strategy used to select the investments to attain each of the environmental or social characteristics promoted by this financial product?

The binding elements are:

- Minimum rating coverage: At least 70% of the Sub-Fund's portfolio is required to have an SRI Rating (portfolio in this respect does not comprise non-rated derivatives and instruments that are non-rated by nature e.g., cash and deposits). While most holdings of the Sub-Fund will have a corresponding SRI Rating some investments cannot be rated according to the SRI Research methodology. Examples of instruments not attaining to the SRI Rating include, but are not limited to cash, deposits, Target Funds, and non-rated investments.
- The rated instruments are adhering to the minimum rating threshold of 1 (out of a rating scale from 0 – 4; 0 being the worst rating and 4 the best rating).
- Application of the following sustainable minimum exclusion criteria for direct investments:
 - securities issued by companies having a severe violation / breach of principles and guidelines such as the Principles of the United Nations Global Compact, the OECD Guidelines for Multinational Enterprises, and the United Nations Guiding Principles for Business and Human Rights on the grounds of problematic practices around human rights, labour rights, environment, and corruption issues,
 - securities issued by companies involved in controversial weapons (anti-personnel mines, cluster munitions, chemical weapons, biological weapons, depleted uranium, white phosphorus, and nuclear weapons),
 - securities issued by companies that derive more than 10% of their revenues from weapons, military equipment, and services,
 - securities issued by companies that derive more than 10% of their revenue from thermal coal extraction,
 - securities issued by utility companies that generate more than 20% of their revenues from coal,
 - securities issued by companies involved in the production of tobacco, and securities issued by companies involved in the distribution of tobacco with more than 5% of their revenues.

Direct investments in sovereign issuers with an insufficient freedom house index score are excluded.

The sustainable minimum exclusion criteria are based on information from an external data provider and coded in pre- and post-trade compliance. The review is performed at least half yearly.

- **What is the committed minimum rate to reduce the scope of the investments considered prior to the application of that investment strategy?**

The Sub-Fund does not commit to reduce the scope of the investments by a certain minimum rate.

- **What is the policy to assess good governance practices of the investee companies?**

Good governance principles are considered by screening out companies based on their involvement in controversies around international norms corresponding to the four good governance practices: sound management structures, employee relations, remuneration of staff and tax compliance. Companies having a severe violation in either of those areas will not be investible. For certain cases, flagged issuers shall be on a watch list. These companies will appear on this watch list when the Investment Manager believes that engagement may lead to improvements or when the company is assessed to take remedial actions. Companies on the watch list remain investible unless the Investment Manager believes that the engagement or the remedial actions of the company does not lead to the desired remedy of the severe controversy.

In addition, the Sub-Fund’s Investment Manager is committed to actively encourage open dialogues with investee companies on corporate governance, proxy voting and broader sustainability issues in advance of shareholder meetings (regularly for direct investments in shares). The Sub-Fund’s Investment Manager’s approach to proxy voting and company engagement is set out in the Management Company’s Stewardship Statement.

Good governance practices include sound management structures, employee relations, remuneration of staff and tax compliance.



What is the asset allocation planned for this financial product?

Asset allocation describes the share of investments in specific assets.

Min. 70% of the Sub-Funds’ assets (excluding cash and non-rated derivatives) are used to meet the environmental or social characteristics promoted by this Sub-Fund. A low portion of the Sub-Fund might contain assets which do not promote environmental or social characteristics. Examples of such instruments are derivatives, cash and deposits, some Target Funds and investment with temporarily divergent or absent environmental, social, or good governance qualifications. Min. 5% of the Sub-Funds' assets will be invested in Sustainable Investments. The minimum percentage of investments that are aligned with the EU Taxonomy is 0.01%. The Sub-Fund’s Investment Manager does not commit to a minimum share of environmentally Sustainable Investments that are not aligned with the EU Taxonomy. The Sub-Fund’s Investment Manager does not commit to a minimum share of socially sustainable investments. While the Sub-Fund cannot commit to a minimum share of environmentally or socially sustainable investments, such investments may be freely allocated to within the Sub-Fund aggregated sustainable investment commitment disclosed (min. 5%).

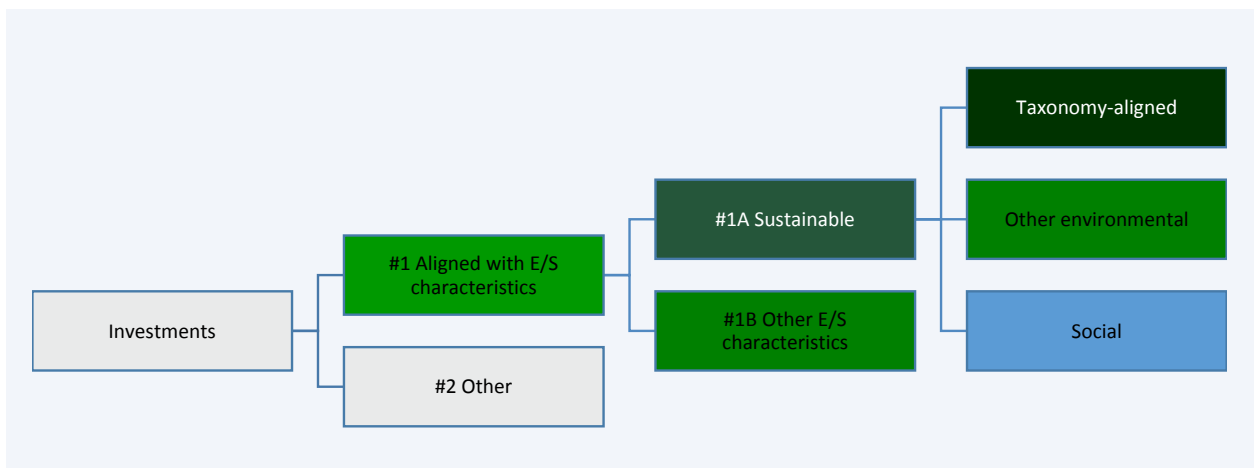

#1 Aligned with E/S characteristics includes the investments of the financial product used to attain the environmental or social characteristics promoted by the financial product.

#2 Other includes the remaining investments of the financial product which are neither aligned with the environmental or social characteristics, nor are qualified as sustainable investments.

The category **#1 Aligned with E/S characteristics** covers:

- The sub-category **#1A Sustainable** covers sustainable investments with environmental or social objectives.
- The sub-category **#1B Other E/S characteristics** covers investments aligned with the environmental or social characteristics that do not qualify as sustainable investments.

- How does the use of derivatives attain the environmental or social characteristics promoted by the financial product?

Not applicable



To what minimum extent are sustainable investments with an environmental objective aligned with the EU Taxonomy?

The Taxonomy-aligned investments include debt and/or equity in environmentally sustainable economic activities aligned with the EU-Taxonomy. The minimum percentage of investments that are aligned with the EU Taxonomy is 0.01%. Taxonomy-aligned data is provided by an external data provider. The Investment Manager has assessed the quality of such data. The data will not be subject to an assurance provided by auditors or a review by third parties. The data will not reflect any data in government bonds. As of today, there is no recognized methodology available to determine the proportion of Taxonomy-aligned activities when investing in government bonds.

Taxonomy-aligned activities in this disclosure are based on share of turnover. Pre-contractual figures use turnover as its financial metric as a default in line with the regulatory requirements and based on the fact that complete, verifiable or up-to date data for CAPEX and/or OPEX as financial metric is even less available.

Taxonomy-aligned data is only in rare cases data reported by companies in accordance with the EU Taxonomy. The data provider has derived Taxonomy-aligned data from other available equivalent public data.

- Does the financial product invest in fossil gas and/or nuclear energy related activities that comply with the EU Taxonomy ¹?

Yes:

In fossil gas In nuclear energy

No

The Sub-Fund does not pursue any investments in fossil gas and/or nuclear energy related activities that comply with the EU Taxonomy. Nevertheless, as result of this investment strategy, investments may occur in corporates which are also active in these activities. Further information will be provided as part of the annual reporting, if relevant.

The two graphs below show in green the minimum percentage of investments that are aligned with the EU Taxonomy. As there is no appropriate methodology to determine the Taxonomy-alignment of sovereign bonds*, the first graph shows the Taxonomy-alignment in relation to all the investments of the financial product including sovereign bonds, while the second graph shows the Taxonomy-alignment only in relation to the investments of the financial product other than sovereign bonds.

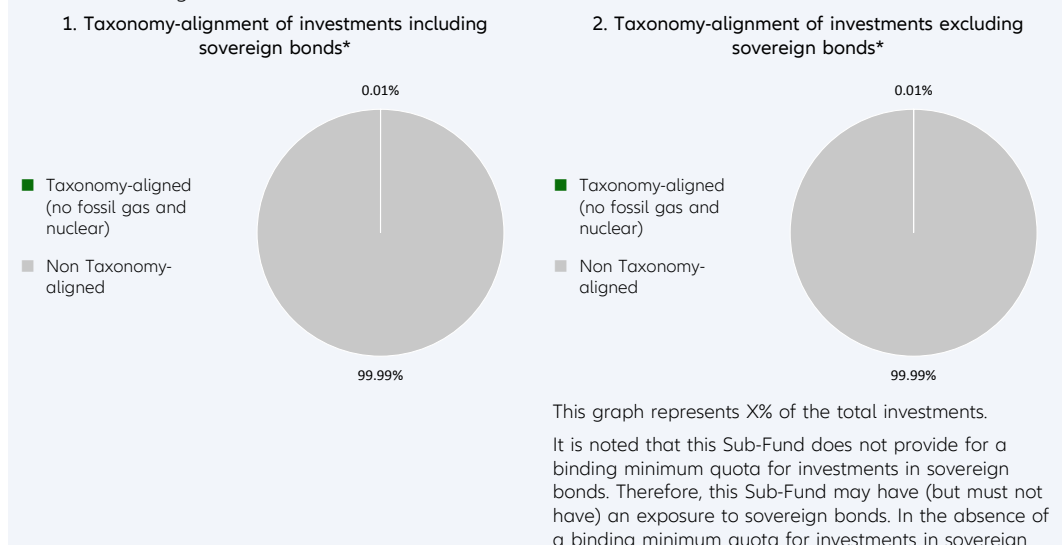

¹ Fossil gas and/or nuclear related activities will only comply with the EU Taxonomy where they contribute to limiting climate change ("climate change mitigation") and do not significantly harm any EU Taxonomy objective - see explanatory note in the left hand margin. The full criteria for fossil gas and nuclear energy economic activities that comply with the EU Taxonomy are laid down in Commission Delegated Regulation (EU) 2022/1214.

bonds, this graph does not generate any additional added value compared to the left-hand graph.

* For the purpose of these graphs, 'sovereign bonds' consist of all sovereign exposures

Enabling activities directly enable other activities to make a substantial contribution to an environmental objective.

Transitional activities are activities for which low-carbon alternatives are not yet available and among others have greenhouse gas emission levels corresponding to the best performance.

● What is the minimum share of investments in transitional and enabling activities?

The Sub-Fund's Investment Manager does not commit to a split of minimum taxonomy alignment into transitional, enabling activities and own performance.



What is the minimum share of sustainable investments with an environmental objective that are not aligned with the EU Taxonomy?

Taxonomy-aligned investments are considered a sub-category of Sustainable Investments. If an investment is not Taxonomy-aligned since the activity is not yet covered under the EU Taxonomy or the positive contribution is not substantial enough to comply with the Taxonomy technical screening criteria, the investment can still be considered an environmentally Sustainable Investment provided it complies with all criteria. The Investment Manager does not commit to a minimum share of environmentally Sustainable Investments that are not aligned with the EU Taxonomy. The overall sustainable investment share may also include investments with an environmental objective in economic activities that do not qualify as environmentally sustainable under the EU Taxonomy, and while the Sub-Fund cannot commit to a minimum share of environmentally or socially sustainable investments, such investments may be freely allocated to within the Sub-Fund aggregated sustainable investment commitment disclosed (min. 5%).



are sustainable investments with an environmental objective that **do not take into account the criteria** for environmentally sustainable economic activities under the EU Taxonomy.



What is the minimum share of socially sustainable investments?

The Investment Manager defines Sustainable Investments based on internal research, which uses, among others, the UN Sustainable Development Goals (SDGs), as well as the objectives of the EU Taxonomy as reference frameworks. The Investment Manager does not commit to a minimum share of socially Sustainable Investments, as the SDGs contain environmental as well as social objectives. The overall sustainable investment share may also include investments with a social objective, and while the Sub-Fund cannot commit to a minimum share of environmentally or socially sustainable investments, such investments may be freely allocated to within the Sub-Fund aggregated sustainable investment commitment disclosed (min. 5%).



What investments are included under "#2 Other", what is their purpose and are there any minimum environmental or social safeguards?

Under "#2 Other" investments into cash, Target Funds, or derivatives can be included. Derivatives might be used for efficient portfolio management (including risk hedging) and/or investment purposes, and Target Funds to benefit from a specific strategy. For those investments no environmental or social safeguards are applied.



Is a specific index designated as a reference benchmark to determine whether this financial product is aligned with the environmental and/or social characteristics that it promotes?

No reference benchmark has been designated for the purpose of attaining the environmental and/or social characteristics promoted by the Sub-Fund.

Reference benchmarks are indexes to measure whether the financial product attains the environmental or social characteristics that they promote.

- **How is the reference benchmark continuously aligned with each of the environmental or social characteristics promoted by the financial product?**
Not applicable
- **How is the alignment of the investment strategy with the methodology of the index ensured on a continuous basis?**
Not applicable
- **How does the designated index differ from a relevant broad market index?**
Not applicable
- **Where can the methodology used for the calculation of the designated index be found?**
Not applicable



Where can I find more product specific information online?

More product-specific information can be found on the website: <https://regulatory.allianzgi.com/SFDR>

Template pre-contractual disclosure for the financial products referred to in Article 8, paragraphs 1, 2 and 2a, of Regulation (EU) 2019/2088 and Article 6, first paragraph, of Regulation (EU) 2020/852

Product name:

Allianz US Short Duration High Income Bond

Legal entity identifier: 549300AGX4LFUYBR5189

Environmental and/or social characteristics

Sustainable investment means an investment in an economic activity that contributes to an environmental or social objective, provided that the investment does not significantly harm any environmental or social objective and that the investee companies follow good governance practices.

The **EU Taxonomy** is a classification system laid down in Regulation (EU) 2020/852, establishing a list of **environmentally sustainable economic activities**. That Regulation does not include a list of socially sustainable economic activities. Sustainable investments with an environmental objective might be aligned with the Taxonomy or not.

Does this financial product have a sustainable investment objective?

<input checked="" type="radio"/> <input checked="" type="radio"/> Yes		<input type="radio"/> <input checked="" type="radio"/> No	
<input type="checkbox"/> It will make a minimum of sustainable investments with an environmental objective: ___%	<input checked="" type="checkbox"/> It promotes Environmental/Social (E/S) characteristics and while it does not have as its objective a sustainable investment, it will have a minimum proportion of 3.00% of sustainable investments	<input type="checkbox"/> in economic activities that qualify as environmentally sustainable under the EU Taxonomy	<input checked="" type="checkbox"/> with an environmental objective in economic activities that qualify as environmentally sustainable under the EU Taxonomy
<input type="checkbox"/> in economic activities that do not qualify as environmentally sustainable under the EU Taxonomy	<input checked="" type="checkbox"/> with an environmental objective in economic activities that do not qualify as environmentally sustainable under the EU Taxonomy	<input type="checkbox"/> It will make a minimum of sustainable investments with a social objective ___%	<input checked="" type="checkbox"/> with a social objective
<input type="checkbox"/> It promotes E/S characteristics, but will not make any sustainable investments			



What environmental and/or social characteristics are promoted by this financial product?

Allianz US Short Duration High Income Bond (the "Sub-Fund") is managed according to the Sustainability Key Performance Indicator Strategy (Absolute) ("KPI Strategy (Absolute)") which addresses greenhouse gas (GHG) Intensity. The "Sustainability KPI" measures the GHG Intensity defined by the weighted average intensity of greenhouse gas emissions based on a company's annual sales ("GHG Intensity").

GHG Intensity will be addressed by ensuring a year-on-year improvement pathway of the weighted average GHG Intensity on portfolio level for the prospective fiscal year ends of the Sub-Fund.

In addition, sustainable minimum exclusion criteria apply.

No reference benchmark has been designated for the purpose of attaining the environmental and/or social characteristics promoted by the Sub-Fund.

● What sustainability indicators are used to measure the attainment of each of the environmental or social characteristics promoted by this financial product?

To measure the attainment of the environmental and/or social characteristics the following sustainability indicators are used and reported on, at the fiscal year end:

- The actual percentage of KPI coverage of the Sub-Fund's Portfolio (Portfolio in this respect does not comprise derivatives and instruments that are non-evaluated by nature (e. g., cash and deposits)).
- The year-on-year improvement pathway of the Sub-Fund's Weighted Average GHG Intensity.

Sustainability indicators measure how the environmental or social characteristics promoted by the financial product are attained.

- Confirmation that Principal Adverse Impacts (PAIs) of investment decisions on sustainability factors are considered through the application of exclusion criteria.

- **What are the objectives of the sustainable investments that the financial product partially intends to make and how does the sustainable investment contribute to such objectives?**

Sustainable investments contribute to environmental and/or social objectives, for which the Investment Manager uses as reference frameworks, among others, the UN Sustainable Development Goals (SDGs), as well as the objectives of the EU Taxonomy:

1. Climate Change Mitigation
2. Climate Change Adaptation
3. Sustainable Use and Protection of Water and Marine Resources
4. Transition to a Circular Economy
5. Pollution Prevention and Control
6. Protection and Restoration of Biodiversity and Ecosystems

The assessment of the positive contribution to the environmental or social objectives is based on a proprietary framework which combines quantitative elements with qualitative inputs from internal research. The methodology applies first a quantitative breakdown of a securities issuer into its business activities. The qualitative element of the framework is an assessment if business activities contribute positively to an environmental or a social objective.

To calculate the positive contribution on the Sub-Fund level the revenue share of each issuer attributable to business activities contributing to environmental and/or social objectives is considered provided the issuer is satisfying the Do No Significant Harm (“DNSH”) and Good Governance principles, and an asset-weighted aggregation is performed as a second step. Moreover, for certain types of securities, which finance specific projects contributing to environmental or social objectives the overall investment is considered to contribute to environmental and/or social objectives, but also for these a DNSH as well as a Good Governance check for issuers is performed.

- **How do the sustainable investments that the financial product partially intends to make, not cause significant harm to any environmental or social sustainable investment objective?**

In order to ensure that Sustainable Investments do not significantly harm any other environmental and/or social objective, the Investment Manager is leveraging the PAI indicators, whereby significance thresholds have been defined to identify significantly harmful issuers. Issuers not meeting the significance threshold can be engaged for a limited time period to remediate the adverse impact. Otherwise, if the issuer does not meet the defined significance thresholds twice subsequently or in case of a failed engagement, it does not pass the DNSH assessment. Investments in securities of issuers which do not pass the DNSH assessment are not counted as sustainable investments.

- *How have the indicators for adverse impacts on sustainability factors been taken into account?*

All mandatory PAI indicators are considered either as part of the application of the exclusion criteria or through thresholds on a sectorial or absolute basis. Significance thresholds have been defined and they refer to qualitative or quantitative criteria.

Recognizing the lack of data coverage for some of the PAI indicators equivalent data points are used to assess PAI indicators when applying the DNSH assessment, when relevant, for the following indicators for corporates: share of non-renewable energy consumption and production, activities negatively affecting biodiversity-sensitive areas, emissions to water, lack of processes and compliance mechanisms to monitor compliance with UNGC principles and OECD Guidelines for Multinational Enterprises; for sovereigns: GHG Intensity and investee countries subject to social violations. In case of securities which finance specific projects contributing to environmental or social objectives equivalent data at project level might be used to ensure that Sustainable Investments do not significantly harm any other environmental and/or social objective. The Investment Manager will strive to increase data coverage for PAI indicators with low data coverage by engaging with issuers and data providers. The Investment Manager will regularly evaluate whether the availability of data has increased sufficiently to potentially include assessment of such data in the investment process.

Principal adverse impacts are the most significant negative impacts of investment decisions on sustainability factors relating to environmental, social and employee matters, respect for human rights, anti-corruption and anti-bribery matters.

- *How are the sustainable investments aligned with the OECD Guidelines for Multinational Enterprises and the UN Guiding Principles on Business and Human Rights? Details:*

The Investment Manager's sustainable minimum exclusion list screens out companies based on their involvement in controversial practices against international norms. The core normative framework consists of the Principles of the UN Global Compact, the OECD Guidelines for Multinational Enterprises and the UN Guiding Principles for Business and Human Rights. Securities issued by companies having a severe violation of these frameworks will be restricted from the investment universe.

The EU Taxonomy sets out a "do not significant harm" principle by which Taxonomy-aligned investments should not significantly harm EU Taxonomy objectives and is accompanied by specific EU criteria.

The "do not significant harm" principle applies only to those investments underlying the financial product that take into account the EU criteria for environmentally sustainable economic activities. The investments underlying the remaining portion of this financial product do not take into account the EU criteria for environmentally sustainable economic activities.

Any other sustainable investments must also not significantly harm any environmental or social objectives.



Does this financial product consider principal adverse impacts on sustainability factors?

Yes

No

The Management Company has joined the Net Zero Asset Manager Initiative and considers PAI indicators through stewardship including engagement, both are relevant to mitigate potential adverse impact as a company.

Due to the commitment to the Net Zero Asset Manager Initiative, the Management Company aims to reduce greenhouse gas emissions in partnership with asset owner clients on decarbonisation goals, consistent with an ambition to reach net zero emission by 2050 or sooner across all assets under management. As part of this objective the Management Company will set an interim target for the proportion of assets to be managed in line with the attainment of net zero emissions by 2050 or sooner.

The Sub-Fund's Investment Manager addresses PAI indicators regarding greenhouse gas emission, biodiversity, water, waste as well as social and employee matters for corporate issuers, and, where relevant, the freedom house index is applied to investments in sovereigns. PAI indicators are considered within the Investment Manager's investment process through the means of exclusions as described in the "binding elements" section of the Sub-Fund.

The data coverage for the data required for the PAI indicators is heterogenous. The data coverage related to biodiversity, water and waste is low and the related PAI indicators are considered through exclusion of securities issued by companies having a severe violation / breach of principles and guidelines such as the Principles of the United Nations Global Compact, the OECD Guidelines for Multinational Enterprises, and the United Nations Guiding Principles for Business and Human Rights on the grounds of problematic practices around human rights, labour rights, environment, and corruption issues. Therefore, the Investment Manager will strive to increase data coverage for PAI indicators with low data coverage. The Investment Manager will regularly evaluate whether the availability of data has increased sufficiently to potentially include assessment of such data in the investment process.

Additionally, the Investment manager considers GHG related PAI indicators by ensuring a Weighted Average GHG Intensity improvement pathway. The following PAI indicators are considered:

Applicable to corporate issuers

- GHG Emissions
- Carbon footprint
- GHG Intensity of investee companies
- Exposure to companies active in the fossil fuel sector
- Activities negatively affecting biodiversity-sensitive areas
- Emissions to water
- Hazardous waste ratio
- Violation of UN Global compact principles

- Lack of processes and compliance mechanisms to monitor compliance with UN Global Compact principles
- Board gender diversity
- Exposure to controversial weapons

Applicable to sovereign and supranational issuers

- Investee countries subject to social violations

The information on the PAI indicators will be available in the end-year report of the Sub-Fund.



What investment strategy does this financial product follow?

The investment strategy guides investment decisions based on factors such as investment objectives and risk tolerance.

Allianz US Short Duration High Income Bond's investment objective is to invest in short duration high yield rated corporate Debt Securities of US Bond Markets in accordance with the Sustainability Key Performance Indicator Strategy (Absolute) ("KPI Strategy (Absolute)").

The Sub-Fund's strategy is to achieve, at least, a year-on-year improvement pathway on the Sub-Fund's weighted average Sustainability KPI. The Sustainability KPI measures the GHG Intensity defined by the weighted average intensity of greenhouse gas emissions based on a company's annual sales ("GHG Intensity"). In order to reach this target, the Investment Manager will proceed to yearly checks, comparing the Sub-Fund's Sustainability KPI to the annual improvement pathway (time series) of the Sustainability KPI. The time series will be established at the first day of application of the Sustainability KPI (reference date) using the target annual improvement rate for the prospective fiscal year ends of the Sub-Fund. For each fiscal year end of the time series, the annual improvement rate will be applied to the value of the previous fiscal year end target. For the period between Reference Point and the first fiscal year end a pro rata temporis rate of the annual rate will be applied.

The weighted average GHG Intensity is the weighted average of the Sub-Fund's GHG Intensity (in tCO₂e per Millions of sales). Sales represent company's annual sales. This ratio of GHG normalized by Sales facilitates comparison between companies of different sizes. The metric allows comparing weighted average GHG Intensities of different portfolios to identify portfolios comprised of more GHG-efficient issuers in terms of the issuer's sales. The portfolio weights (and benchmark or universe weights) are rebased such that only issuers with GHG emissions data available are considered in the calculation. GHG represents a respective issuer's greenhouse gas emissions. To determine the GHG Intensity of a company issuer, GHG Intensity data from third party data providers will be used. The GHG intensity is analysed by the Investment Manager and is considered within the securities selection process in order to meet the Sub-Fund Investment objective.

The proportion of assets which do not have a GHG intensity assessment is expected to be low. Examples of instruments not having a GHG intensity assessment are cash and deposits, some Target Funds, and investments for which the GHG intensity is deemed to be not appropriate and/or data is not available.

The Sub-Fund's general investment approach (Sub-Fund's applicable General Asset Class Principles in combination with its individual investment restrictions) is described in the prospectus.

● What are the binding elements of the investment strategy used to select the investments to attain each of the environmental or social characteristics promoted by this financial product?

The binding elements are:

- Min. 70% KPI coverage of the Sub-Fund's Portfolio (Portfolio in this respect does not comprise derivatives and instruments that are non-evaluated by nature (e. g., cash and deposits)).
- At least a 5% year-on-year improvement pathway of the Sub-Fund's Weighted Average GHG Intensity starting at the reference date May 30, 2023. For the period between Reference Point and the first fiscal year end a pro rata temporis rate of the annual rate will be applied.
- Application of the following sustainable minimum exclusion criteria for direct investments:
 - securities issued by companies having a severe violation / breach of principles and guidelines such as the Principles of the United Nations Global Compact, the OECD Guidelines for Multinational Enterprises, and the United Nations Guiding Principles for Business and Human Rights on the grounds of problematic practices around human rights, labour rights, environment, and corruption,
 - securities issued by companies involved in controversial weapons (anti-personnel mines, cluster munitions, chemical weapons, biological weapons, depleted uranium, white phosphorus, and nuclear weapons),

- securities issued by companies that derive more than 10% of their revenues from weapons, military equipment, and services,
- securities issued by companies that derive more than 10% of their revenue from thermal coal extraction
- securities issued by utility companies that generate more than 20% of their revenues from coal,
- securities issued by companies involved in the production of tobacco, and securities issued by companies involved in the distribution of tobacco with more than 5% of their revenues.

Direct investments in sovereign issuers with an insufficient freedom house index score are excluded.

The sustainable minimum exclusion criteria are based on information from an external data provider and coded in pre- and post-trade compliance. The review is performed at least half yearly.

● **What is the committed minimum rate to reduce the scope of the investments considered prior to the application of that investment strategy?**

The Sub-Fund does not commit to reduce the scope of the investments by a certain minimum rate.

● **What is the policy to assess good governance practices of the investee companies?**

Good governance principles are considered by screening out companies based on their involvement in controversies around international norms corresponding to the four good governance practices: sound management structures, employee relations, remuneration of staff and tax compliance. Companies having a severe violation in either of those areas will not be investible. For certain cases, flagged issuers shall be on a watch list. These companies will appear on this watch list when the Investment Manager believes that engagement may lead to improvements or when the company is assessed to take remedial actions. Companies on the watch list remain investible unless the Investment Manager believes that the engagement or the remedial actions of the company does not lead to the desired remedy of the severe controversy.

In addition, the Sub-Fund's Investment Manager is committed to actively encourage open dialogues with investee companies on corporate governance, proxy voting and broader sustainability issues in advance of shareholder meetings (regularly for direct investments in shares). The Sub-Fund's Investment Manager's approach to proxy voting and company engagement is set out in the Management Company's Stewardship Statement.

Good governance practices include sound management structures, employee relations, remuneration of staff and tax compliance.



What is the asset allocation planned for this financial product?

Asset allocation describes the share of investments in specific assets.

Min. 70% of the Sub-Funds' assets (excluding cash, and derivatives) are used to meet the environmental or social characteristics promoted by this Sub-Fund. A low portion of the Sub-Fund might contain assets which do not promote environmental or social characteristics. Example of such instruments are derivatives, cash and deposits, some Target Funds and investment with temporarily divergent or absent environmental, social, or good governance qualifications. Min. 3% of the Sub-Funds' assets will be invested in Sustainable Investments. The Sub-Fund's Investment Manager does not commit to a minimum share of sustainable investments with an environmental objective aligned with the EU Taxonomy nor to a minimum share of environmentally Sustainable Investments that are not aligned with the EU Taxonomy. The Sub-Fund's Investment Manager does not commit to a minimum share of socially sustainable investments. While the Sub-Fund cannot commit to a minimum share of environmentally or socially sustainable investments, such investments may be freely allocated to within the Sub-Fund aggregated sustainable investment commitment disclosed (min. 3%).

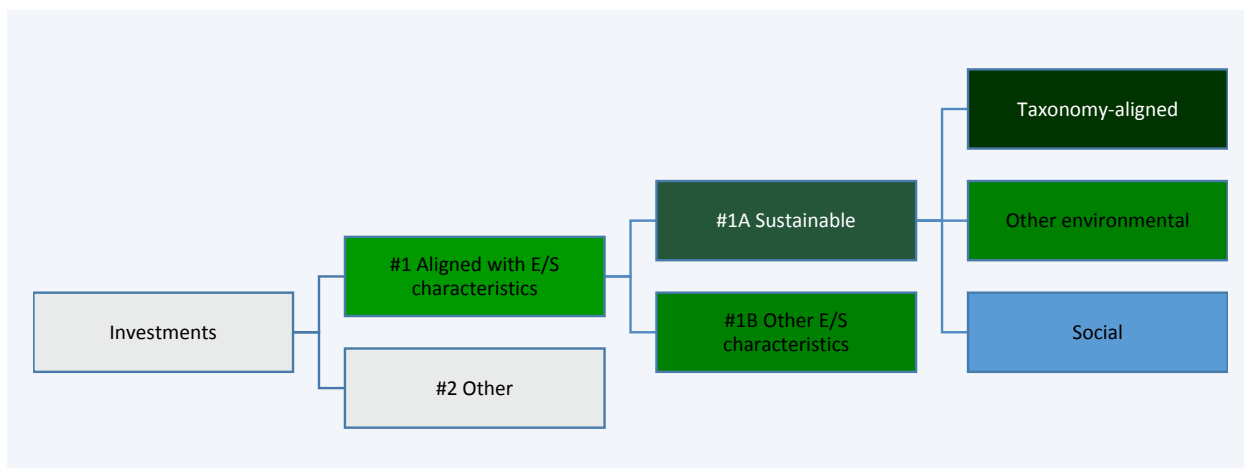

#1 Aligned with E/S characteristics includes the investments of the financial product used to attain the environmental or social characteristics promoted by the financial product.

#2 Other includes the remaining investments of the financial product which are neither aligned with the environmental or social characteristics, nor are qualified as sustainable investments.

The category **#1 Aligned with E/S characteristics** covers:

- The sub-category **#1A Sustainable** covers sustainable investments with environmental or social objectives.
- The sub-category **#1B Other E/S characteristics** covers investments aligned with the environmental or social characteristics that do not qualify as sustainable investments.

- **How does the use of derivatives attain the environmental or social characteristics promoted by the financial product?**

Not applicable



To what minimum extent are sustainable investments with an environmental objective aligned with the EU Taxonomy?

The Sub-Fund’s Investment Manager does not commit to a minimum share of sustainable investments with an environmental objective aligned with the EU Taxonomy. The overall sustainable investment share may also include investments with an environmental objective in economic activities that qualify as environmentally sustainable under the EU Taxonomy.

- **Does the financial product invest in fossil gas and/or nuclear energy related activities that comply with the EU Taxonomy¹?**

- Yes:
 - In fossil gas
 - In nuclear energy

No

The Sub-Fund does not pursue any investments in fossil gas and/or nuclear energy related activities that comply with the EU Taxonomy. Nevertheless, as result of this investment strategy, investments may occur in corporates which are also active in these activities. Further information will be provided as part of the annual reporting, if relevant.

Taxonomy-aligned activities are expressed as a share of:

- **turnover** reflecting the share of revenue from green activities of investee companies
- **capital expenditure (CapEx)** showing the green investments made by investee companies, e.g. for a transition to a green economy.
- **operational expenditure (OpEx)** reflecting green operational activities of investee companies.

¹ Fossil gas and/or nuclear related activities will only comply with the EU Taxonomy where they contribute to limiting climate change (“climate change mitigation”) and do not significantly harm any EU Taxonomy objective - see explanatory note in the left hand margin. The full criteria for fossil gas and nuclear energy economic activities that comply with the EU Taxonomy are laid down in Commission Delegated Regulation (EU) 2022/1214.

The two graphs below show in green the minimum percentage of investments that are aligned with the EU Taxonomy. As there is no appropriate methodology to determine the Taxonomy-alignment of sovereign bonds*, the first graph shows the Taxonomy-alignment in relation to all the investments of the financial product including sovereign bonds, while the second graph shows the Taxonomy-alignment only in relation to the investments of the financial product other than sovereign bonds.

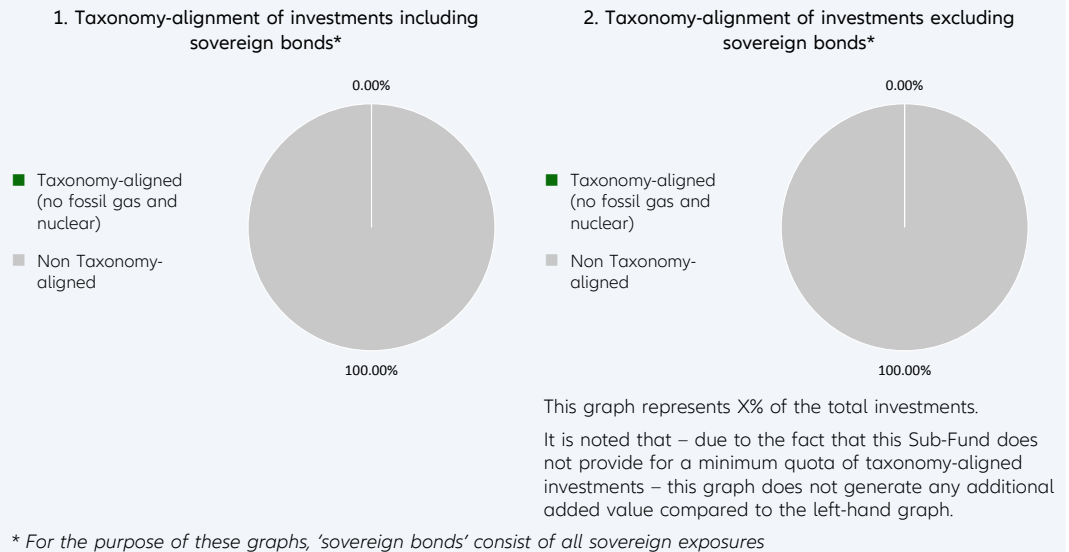

Enabling activities directly enable other activities to make a substantial contribution to an environmental objective.

● **What is the minimum share of investments in transitional and enabling activities?**

The Sub-Fund’s Investment Manager does not commit to a split of minimum taxonomy alignment into transitional, enabling activities and own performance.

Transitional activities are activities for which low-carbon alternatives are not yet available and among others have greenhouse gas emission levels corresponding to the best performance.



What is the minimum share of sustainable investments with an environmental objective that are not aligned with the EU Taxonomy?

Taxonomy-aligned investments are considered a sub-category of Sustainable Investments. If an investment is not Taxonomy-aligned since the activity is not yet covered under the EU Taxonomy or the positive contribution is not substantial enough to comply with the Taxonomy technical screening criteria, the investment can still be considered an environmentally Sustainable Investment provided it complies with all criteria. The Investment Manager does not commit to a minimum share of environmentally Sustainable Investments that are not aligned with the EU Taxonomy. The overall sustainable investment share may also include investments with an environmental objective in economic activities that do not qualify as environmentally sustainable under the EU Taxonomy, and while the Sub-Fund cannot commit to a minimum share of environmentally or socially sustainable investments, such investments may be freely allocated to within the Sub-Fund aggregated sustainable investment commitment disclosed (min. 3%).

are sustainable investments with an environmental objective that **do not take into account the criteria** for environmentally sustainable economic activities under the EU Taxonomy.



What is the minimum share of socially sustainable investments?

The Investment Manager defines Sustainable Investments based on internal research, which uses, among others, the UN Sustainable Development Goals (SDGs), as well as the objectives of the EU Taxonomy as reference frameworks. The Investment Manager does not commit to a minimum share

of socially Sustainable Investments, as the SDGs contain environmental as well as social objectives. The overall sustainable investment share may also include investments with a social objective, and while the Sub-Fund cannot commit to a minimum share of environmentally or socially sustainable investments, such investments may be freely allocated to within the Sub-Fund aggregated sustainable investment commitment disclosed (min. 3%).



What investments are included under “#2 Other”, what is their purpose and are there any minimum environmental or social safeguards?

Under “#2 Other” investments into cash, Target Funds, or derivatives can be included. Derivatives might be used for efficient portfolio management (including risk hedging) and/or investment purposes, and Target Funds to benefit from a specific strategy. For those investments no environmental or social safeguards are applied.



Is a specific index designated as a reference benchmark to determine whether this financial product is aligned with the environmental and/or social characteristics that it promotes?

No reference benchmark has been designated for the purpose of attaining the environmental and/or social characteristics promoted by the Sub-Fund.

Reference benchmarks are indexes to measure whether the financial product attains the environmental or social characteristics that they promote.

- **How is the reference benchmark continuously aligned with each of the environmental or social characteristics promoted by the financial product?**
Not applicable
- **How is the alignment of the investment strategy with the methodology of the index ensured on a continuous basis?**
Not applicable
- **How does the designated index differ from a relevant broad market index?**
Not applicable
- **Where can the methodology used for the calculation of the designated index be found?**
Not applicable



Where can I find more product specific information online?

More product-specific information can be found on the website: <https://regulatory.allianzgi.com/SFDR>